

INSTALLATION INSTRUCTION

Enclosed Safety Switches

OTE16...90_

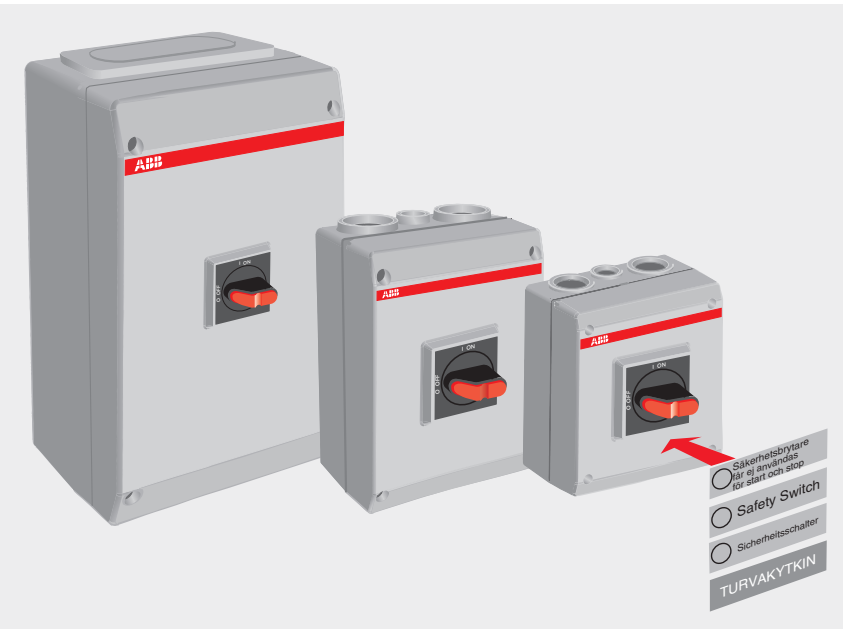

Terminal markings

OTE_3_

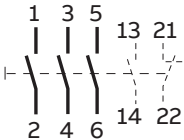

OTE_4_

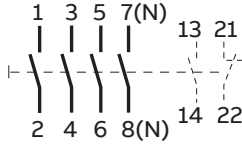

OTE_6_

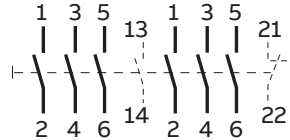

Opening of cover

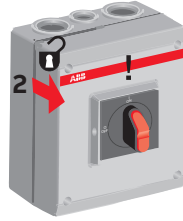
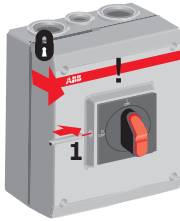

A0006441

Cable input

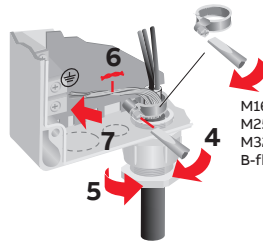
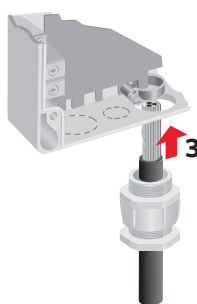
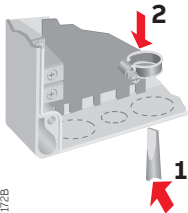

M16 = 2,5 Nm
 M25 = 2,5 Nm
 M32 = 2,5 Nm
 B-flange/M50 = 3 Nm

A00172B

Wiring for OTE16_

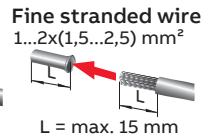
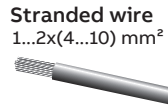
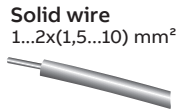
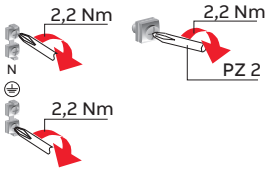

OTE16_3_, OTE_16_4_

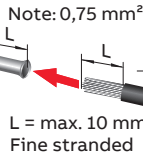
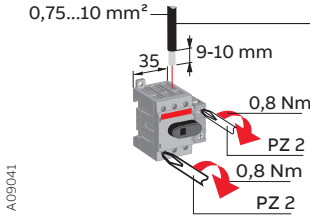

OTE16_6_

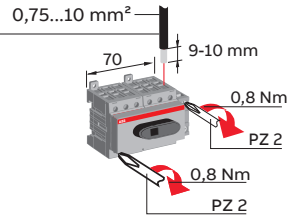

A09041

Dimension drawings

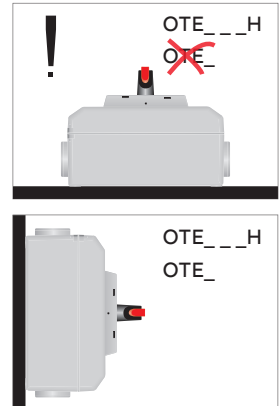
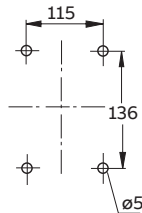
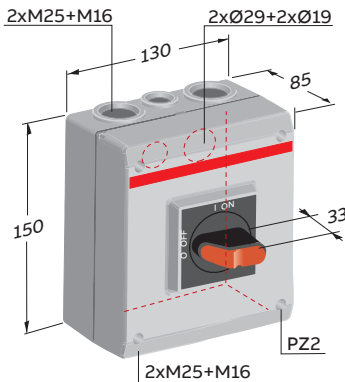

A09042A

Wiring for OTE25_ to OTE63_

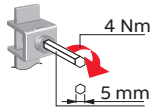
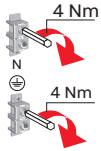

Solid wire
(1,5...35) mm²



Stranded wire
(6...35) mm²



Fine stranded wire
(1,5...4) mm²

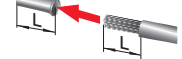

L = max. 15 mm

OTE25_3_, OTE25_4_
OTE36_3_, OTE36_4_

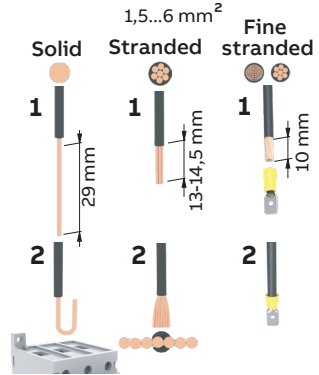
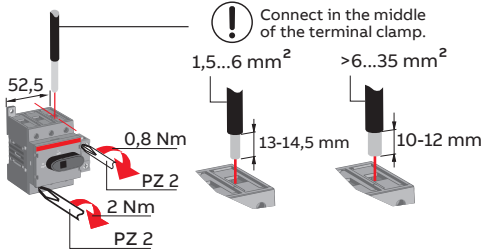

OTE 63_3_

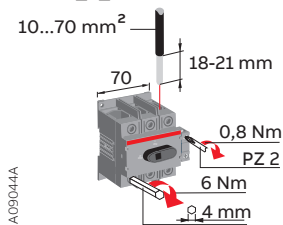

A09044A

Dimension drawings

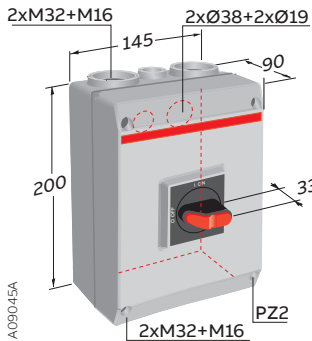

A09045A

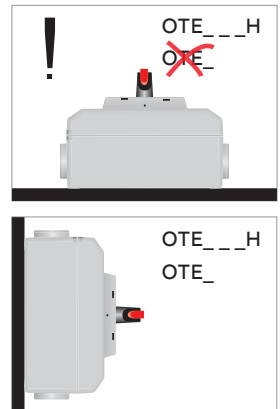
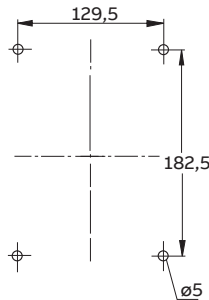

Wiring for OTE25_ to OTE90_

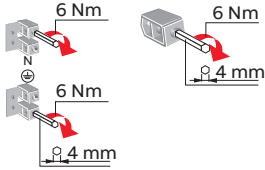

Solid and stranded wire (10...70)mm²

Fine stranded wire (10...70)mm²

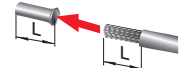

L = max. 25 mm

OTE_25_6_, OTE_36_6_

! Connect in the middle of the terminal clamp.

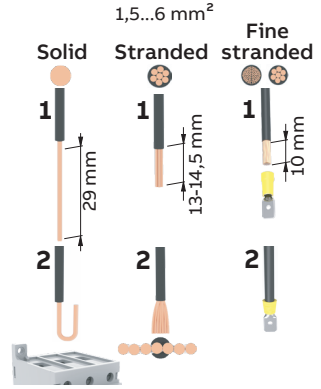
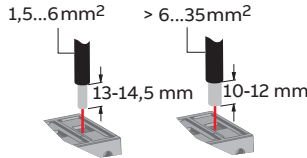
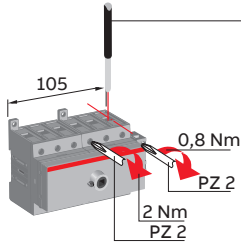

OTE_75_3_, OTE_75_4_,
OTE_90_3_, OTE_90_4_

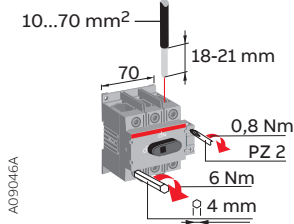

A09046A

OTE_63_6_
OTE_75_6_, OTE_90_6_

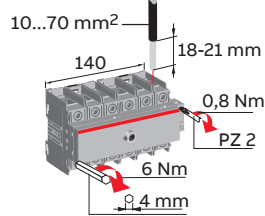

Dimension drawings

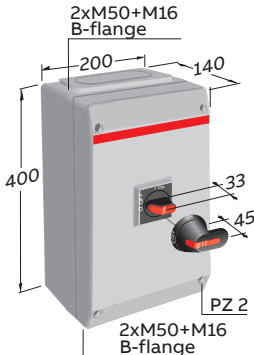

A09048A

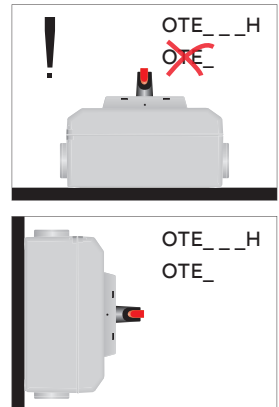
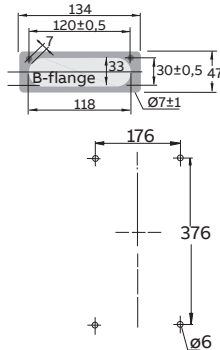

Padlocking handle

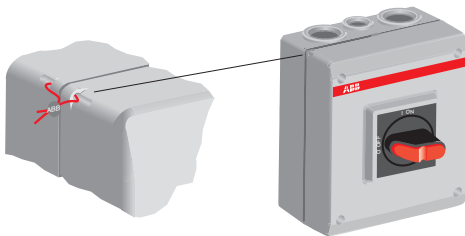
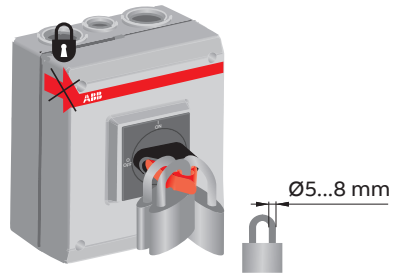
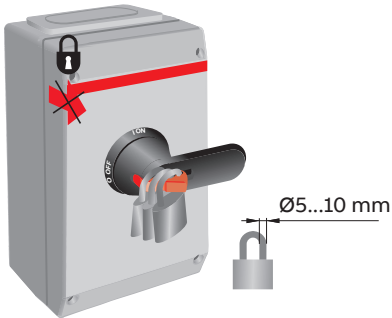
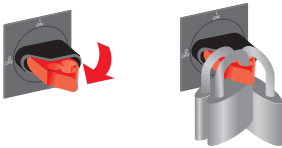



BG	Внимание! Опасно напряжение! Да се монтира само от лице с електротехническа квалификация.
CN	警告！电压危险！只能由专业电工进行安装。
CZ	Varování! Nebezpečné napětí! Montáž smí provádět výhradně elektrotechnik!
DA	Advarsel! Farlig elektrisk spænding! Installation må kun foretages af personer med elektroteknisk ekspertise.
DE	Warnung! Gefährliche Spannung! Installation nur durch elektrotechnische Fachkraft.
EL	Προειδοποίηση! Υψηλή τάση! Η εγκατάσταση πρέπει να γίνεται μόνο από εξειδικευμένους ηλεκτροτεχνικούς.
EN	Warning! Hazardous voltage! Installation by person with electrotechnical expertise only.
ES	¡Advertencia! ¡Tensión peligrosa! La instalación deberá ser realizada únicamente por electricistas especializados.
ET	Hoiatus! Ohtlik pinge. Paigaldada võib ainult elektrotehnika-alane ekspert.
FI	Varoitus! Vaarallinen jännite! Asennuksen voi tehdä vain sähköalan ammattihenkilö.
FR	Avertissement! Tension électrique dangereuse! Installation uniquement par des personnes qualifiées en électrotechnique.
HR	Upozorenje! Opasan napon! Postavljati smije samo elektrotehnički stručnjak.
HU	Figyelmeztetés! Veszélyes feszültség! Csak elektrotechnikai tapasztalattal rendelkező szakember helyezheti üzembe.
IE	Rabhadh! Voltas guaiseach! Ba chóir do dhuine ag a bhfuil saineolas leictriteicniúil, agus an té sin amháin, é seo a shuiteáil.
IT	Avvertenza! Tensione pericolosa! Fare installare solo da un elettricista qualificato.
LT	Dėmesio! Pavojinga įtampa! Dirbti leidžiama tik elektrotechniko patirties turintiems asmenims.
LV	Uzmanību! Bistami - elektrība! Montāžas darbus drīkst veikt tikai personas, kurām ir atbilstoša elektrotehniskās zināšanas.
MT	Twissija! Vultagġ perikoluż! Għandu jiġi installat biss minn persuna b'kompetenza elettroteknika.
NL	Waarschuwing! Gevaarlijke spanning! Mag alleen geïnstalleerd worden door een deskundige elektrotechnicus.
NO	Advarsel! Farlig spenning! Montering skal kun utføres av kvalifiserte personer med elektrokompetanse.
PL	Ostrzeżenie! Niebezpieczne napięcie! Instalacji może dokonać wyłącznie osoba z fachową wiedzą w dziedzinie elektrotechniki.
PT	Aviso! Tensão perigosa! A instalação só deve ser realizada por um electricista especializado.
RO	Avertizare! Tensiune periculoasă! Instalarea trebuie efectuată numai de către o persoană cu experiență în electrotehnică.
RU	Осторожно! Опасное напряжение! Монтаж должен выполняться только специалистом-электриком.
SE	Varning! Farlig spänning! Installation får endast utföras av en elektriker.
SK	Varovanie! Nebezpečné napätie! Montáž môže vykonávať iba skúsený elektrotechnik.
SL	Opozorilo! Nevarna napetost! Montažo mora izvesti izkuseni elektrotehnik.



Contact us

ABB Oy

Muottitie 2A 65320

Vaasa, Finland

abb.com/lowvoltage