

PRODUCT DATASHEET

FL PFM DA SYM R30 200W 3000K BK

FLOODLIGHT PERFORMANCE DALI SYM R30 | DALI 2.0 based floodlight with rotational symmetric light distribution for high mast area lighting



Areas of application

- Direct replacement for luminaires using HID lamps
- Outdoor use (IP66)
- Parking
- Public areas
- Industry
- Sports facilities
- Lighting of large areas
- D-sign according to EN 60598-2-24 for fire-risk commercial unit, e.g. by accumulation of dust

Product benefits

- Energy savings of up to 90 % compared to halogen lamp floodlights
- Energy savings of up to 45 % compared to luminaires that use conventional discharge lamps
- Bright, robust and durable
- Homogeneous luminance distribution and reduced glare
- No upper light output ratio (ULOR 0%) when mounted at 0° tilt
- Key hole to ensure ease of installation
- 5 years guarantee

Product features

- DALI 2.0 interface for light management system integration
- High luminous efficacy: up to 140 lm/W
- Rotational symmetric light distribution for high mast area lighting
- Angled (45°) mounting bracket and up to 180° tilting
- High surge protection: up to 10 kV (L/N-PE), 6 kV (L-N)



- Integrated breather for preventing condensation inside the luminaire
- Connection via 2 m cable, wiring required
- Type of protection: IP66
- Impact resistance: IK08
- Ambient temperature in operation: -30...+50 °C



TECHNICAL DATA

Electrical data

Nominal wattage	200.00 W
Nominal voltage	220...240 V
Mains frequency	50...60 Hz
Nominal current	980.000 mA
Inrush current	110 A
Inrush current time T_{h50}	350 μ s
Max. no. of lum. on circuit break. B16 A	2
Max. no. of lum. on circuit break. C10 A	2
Max. no. of lum. on circuit break. C16 A	4
Power factor λ	> 0.90
Total harmonic distortion	< 10 %
Protection class	I
Operating mode	Integrated LED driver

Photometrical data

Luminous flux	24800 lm
Luminous efficacy	124 lm/W
Color temperature	3000 K
Light color (designation)	Warm white
Color rendering index Ra	> 80
Standard deviation of color matching	\leq 5 sdc _m
Low flicker	Yes
Photobiological safety group acc. to EN62778	RG1
Photobiological safety group acc. to EN62471	RG1
Beam angle	30 °

Dimensions & Weight

Length	494.00 mm
Width	395.00 mm



Height	87.00 mm
Product weight	7000.00 g
Cable length	2000 mm

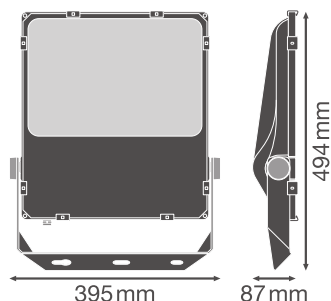

Materials & Colors

Product color	Black
Housing color	Black
Body material	Aluminum
Cover material	Glass
Light emitting surface material	Glass
Glow Wire Test according to IEC 60695-2-12	650 °C
Mercury content	0.0 mg

Application & Mounting

Ambient temperature range	-30...+50 °C
Temperature range at storage	-40...+70 °C
Type of connection	Cable, 5-pole
Type of protection	IP66
Protection class IK (shock resistance)	IK08
Dimmable	Yes
Type of dimming	DALI
Mounting type	Surface
Mounting location	Wall / Pole / Floor / Ceiling
Application environment	Outdoor
Adjustable	Yes
LED module replaceable	Not replaceable
With light source	Yes



Lifespan

Lifespan L70/B50 at 25 °C	100000 h
Lifespan L80/B10 at 25 °C	70000 h
Lifespan L90/B10 at 25 °C	30000 h
Number of switching cycles	100000

Control gear

ECG - Output ripple current	< 10 %
-----------------------------	--------





Certificates & Standards

Standards	CE / CB / ENEC / TÜV SÜD / UKCA / EAC
Luminaire with limited surface temperature, "D sign"	Yes
Ball shot safe	No

Additional product data

Product remark	Available from September 2022
----------------	-------------------------------

DOWNLOAD DATA

DOWNLOAD DATA	
	User instruction
	Addon Technical Information
	IES file (IES)
	LDT file (Eulumdat)
	Packaging insert

LOGISTICAL DATA

Product code	Packaging unit (Pieces/Unit)	Dimensions (length x width x height)	Gross weight	Volume
4058075760745	Shipping box 1	568 mm x 140 mm x 430 mm	6878.00 g	34.20 dm ³

The mentioned product code describes the smallest quantity unit which can be ordered. One shipping unit can contain one or more single products. When placing an order, for the quantity please enter single or multiples of a shipping unit.



ADDITIONAL CATALOG INFORMATION

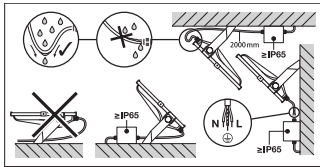
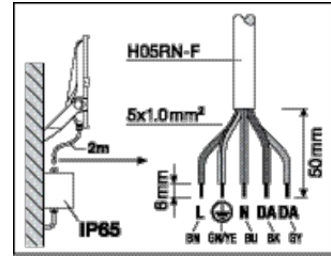
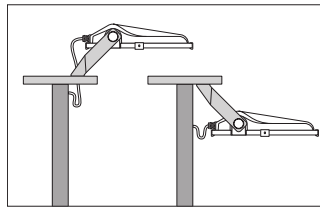
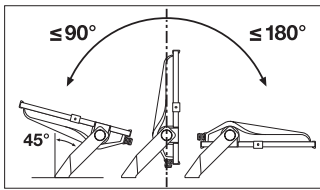

References / Links

- For Guarantee see www.ledvance.com/guarantee

DISCLAIMER

Subject to change without notice. Errors and omission excepted. Always make sure to use the most recent release.

