

PRODUCTINFORMATIEBLAD

DL UGR19 PFM DN195 21 W 830 WT IP54

DOWNLIGHT UGR19 | Downlights met lage verblinding, geschikt voor beeldschermwerkplekken



Toepassingsgebieden

- Geschikt voor kantoortoepassingen, met name voor beeldschermwerkplekken
- Directe vervanging voor armaturen met compact fluorescentielampen
- Ingangen / hallen
- Badkamers, keukens en werkplaatsen
- Algemene verlichting

Productvoordelen

- Goede verblindingsvermindering ($UGR < 19$) en afsnijhoek tot 30° voor comfortabele binnenverlichting
- Eenvoudige en snelle installatie dankzij de Connectorbox met 5-polige terminal
- Laag flikkeringsgehalte
- Geschikt voor gebruik in stoffige en vochtige ruimtes dankzij de hoge IP-classificatie
- 5 jaar garantie

Productkenmerken

- Materiaal behuizing: aluminium spiegelreflector
- Soort bescherming: IP54 (kamerzijde) / IP20 (achterzijde)
- Aansluitdoos met push-wire terminal voor gereedschapvrije aansluiting
- Doorvoerbedrading mogelijk
- Armatuurversies met IoT ready DALI-2 driver of IoT Zigbee 3.0 technologie beschikbaar



TECHNISCHE GEGEVENS

ELEKTRISCHE GEGEVENS

Nominale vermogen	21,00 W
Nominale spanning	220...240 V
Netfrequentie	50...60 Hz
Nominale stroom	120 mA
Inschakelstroom	30 A
Inschakelstroomtijd T_{h50}	200 μ s
Max. armaturen op stroomonderbreke B16 A	120
Max. armaturen op stroomonderbreke C10 A	80
Max. armaturen op stroomonderbreke C16 A	120
Arbeidsfactor λ	$\geq 0,90$
Totale harmonische vervorming	< 20 %
Veiligheidsklasse	II
Bedrijfsmodus	External LED driver

Fotometrische gegevens

Lichtstroom	2400 lm
Lichtstroom efficiëntie	115 lm/W
Kleurtemperatuur	3000 K
Lichtkleur	Warm White
Kleurweergave-index Ra	≥ 80
Standaardafwijking van kleurproeven	≤ 5 sdc _m
Lichtsterkte	-
Flikkervrij	Ja
Flikkerwaarde Pst LM	-
Stroboscoopeffect waarde SVM	-
Fotobiologische veiligheidsgroep EN62778	RG1
Fotobiologische veiligheidsgroep EN62471	RG0
Stralingshoek	65 °
UGR longitudinal	< 19



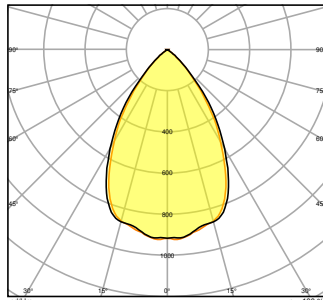
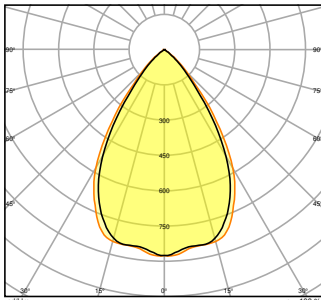
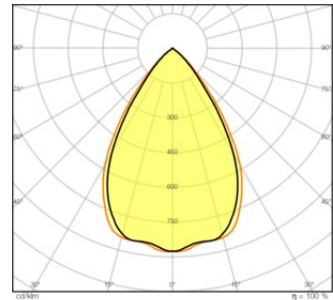
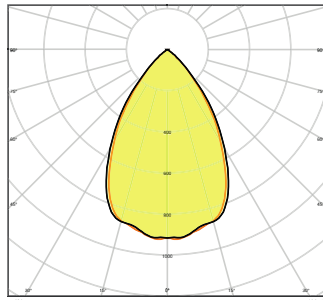
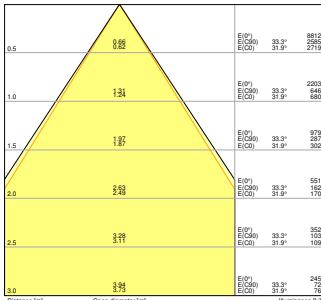
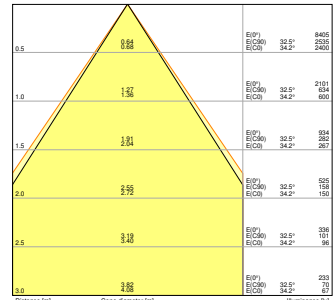
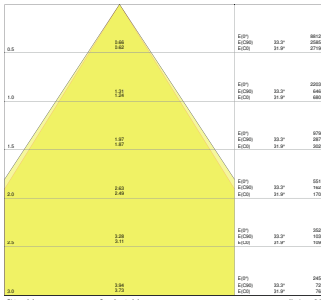

AFMETINGEN & GEWICHT

Diameter	220,00 mm
Hoogte	82,00 mm
Product gewicht	900,00 g

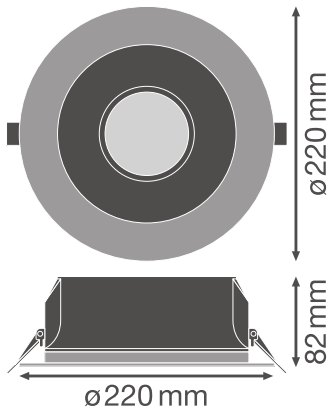

MATERIALEN & KLEUREN

Kleur van het product	Wit
Kleur behuizing	Wit
Body materiaal	Aluminium
Materiaal afdekking	Polycarbonate (PC)
Materiaal van lichtuitstralend oppervlak	Polycarbonaat
Glow Wire Test volgens IEC 60695-2-12	650 °C
Kwikgehalte	0.0 mg

TOEPASSING & MONTAGE

Omgevingstemperatuur bereik	-20...+45 °C
Opslagtemperatuur	-40...+70 °C
Type aansluiting	Schroefloze terminal
Type bescherming	IP54/IP20
Beschermklasse IK (Schok bestendi [PIM])	IK03
Dimmable	Nee
Montagetype	Recessed
Montagelocatie	Plafond
Application environment	IndoorIndoor
Diameter inbouw opening	195,0 mm
Inbouwdiepte	120 mm
Vervangbare LED module	Niet vervangbaar
With light source	Ja

Levensduur



Levensduur L70/B50 @ 25 °C	70000 h
Levensduur L80/B10 @ 25 °C	60000 h
Levensduur L90/B10 @ 25 °C	40000 h
Aantal schakelcycli	100000

VOORSCHAKELAPPARATUUR

Output current	700 mA
ECG - Output ripple current	< 10 %
ECG - Length	114.0 mm
ECG - Width	45 mm
ECG - Height	28 mm
Recommended control gear	OSRAM OTI DALI 50/220-240/1A4 NFC







CERTIFICATEN & NORMEN

Normen	CE / CB / ENEC / TÜV SÜD / EAC
Gelimiteerde oppervlaktetemperatuur	Nee
Balschot veilig	Nee

EQUIPMENT / ACCESSORIES

- Extern voorschakelapparaat inbegrepen

DOWNLOADS

DOWNLOADS	
	User instruction
	Addon Technical Information
	Tender documenten
	Tender documenten
	Declarations of conformity
	IES file (IES)



DOWNLOADS



IES file (IES)



LDT file (Eulumdat)



LDT file (Eulumdat)



R3D file (Relux 3D Model)



M3D file (3D Model)



ULD file (DIALux)



UGR file (UGR table)



UGR file (UGR table)



UGR file (UGR table)



Packaging insert

LOGISTIEKE GEGEVENS

Productcode	Verpakkingseenheid (stuks per verpakking)	Afmetingen (lengte x breedte x hoogte)	Brutogewicht	Volume
4058075459250	Vouwdoos 1	262 mm x 108 mm x 266 mm	1197.00 g	7.53 dm ³
4058075459267	Verzenddoos 16	545 mm x 452 mm x 563 mm	20749.00 g	138.69 dm ³

De genoemde productcodes beschrijven de kleinste hoeveelheid die besteld kan worden. Eén verzendeenheid kan bestaan uit één of meer afzonderlijke producten. Bij het plaatsen van een order enkele of veelvoud van de verpakkingseenheid invoeren.

AANVULLENDE CATALOGUSINFORMATIE



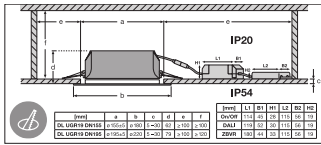
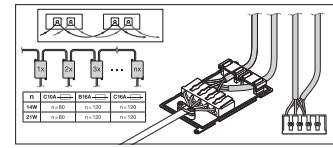
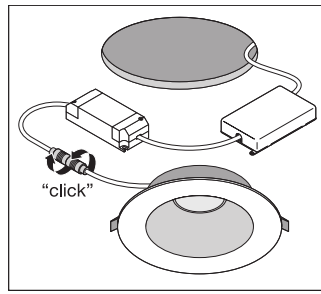
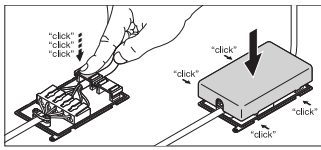

Referenties / Links

- Voor garantie zie www.benelux.ledvance.com/garantie

DISCLAIMER

Onder voorbehoud van verandering zonder kennisgeving. Fouten en drukfouten voorbehouden. Zorg ervoor dat u de meest recente versie gebruikt.

