

PRODUCT DATASHEET

PL CMFT 600 P 28W 840 U19 PS

PANEL COMFORT 600 UGR<19 PS | Square recessed panel luminaires with power select (PS) feature and low glare, for 600 x 600 mm ceiling systems

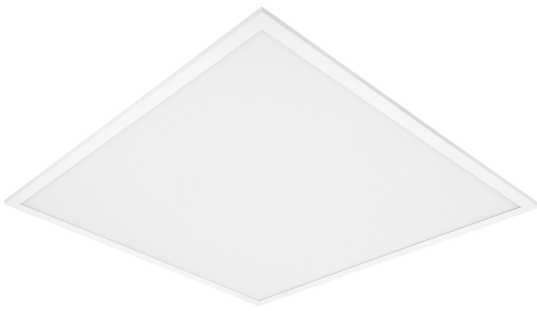

Areas of application

- Direct replacement for recessed luminaires with fluorescent lamps
- Offices, conference rooms
- Reception areas, foyers, corridors, elevators
- Suitable for recessed ceiling systems with grid size of 600 x 600 mm

Product benefits

- Highly versatile due to selectable power steps (Power Select - PS) on the driver
- Tool-free electrical connection due to push button connector
- Through-wiring possible with included connector box
- Energy savings thanks to high system efficacy: up to 130 lm/W
- Good glare reduction ($UGR \leq 19$)
- High color consistency with SDCM 3
- Extended services such as energy monitoring and remote maintenance possible with DALI versions
- External driver for extended flexibility and easy installation
- Low flicker light thanks to special electronic control gear
- Emergency lighting possible with LEDVANCE Emergency Conversion Box
- 5 years guarantee

Product features

- Extruded aluminum frame



- Polystyrene diffuser
- 5-pole terminal block, cable cross section up to 5 x 2.5 mm²
- Luminaire versions with IoT-ready DALI-2 driver available
- Versions available with CRI 90
- Lifetime (L80/B10): 70,000 h (at 25 °C)

TECHNICAL DATA

Electrical data

Nominal wattage	28 W / 25 W / 22 W ¹⁾
Nominal voltage	220...240 V
Mains frequency	50...60 Hz
Nominal current	125.000 mA
Inrush current	9 A
Inrush current time T_{h50}	690 μ s
Max. no. of lum. on circuit break. B16 A	14
Max. no. of lum. on circuit break. C10 A	15
Max. no. of lum. on circuit break. C16 A	24
Power factor λ	> 0.90
Total harmonic distortion	< 20 %
Protection class	II
Operating mode	External LED driver

¹⁾ For possible options refer to lumen/power table image / CRI80 versions of the Panel Comfort family are fulfilling the technical minimum requirements according to the German BEG subsidy program for energy efficient luminaires

Photometrical data

Luminous flux	3640 lm / 3250 lm / 2900 lm ¹⁾
Luminous efficacy	130 lm/W ¹⁾
Color temperature	4000 K
Light color (designation)	Cool White
Color rendering index Ra	> 80
Standard deviation of color matching	≤ 3 sdc _m
Low flicker	Yes
Flickering metric (Pst LM)	<1
Stroboscope effect metric (SVM)	< 0.4
Photobiological safety group acc. to EN62778	RG0
Beam angle	90 °
UGR	< 19

¹⁾ For possible options refer to lumen/power table image / CRI80 versions of the Panel Comfort family are fulfilling the technical minimum requirements according to the German BEG subsidy program for energy efficient luminaires

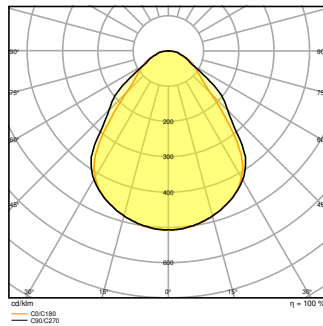
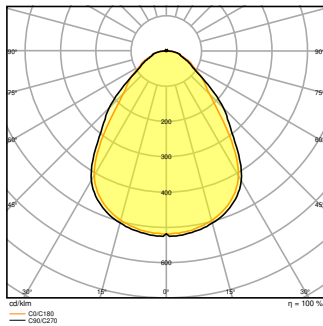
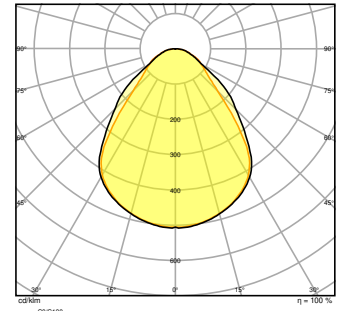
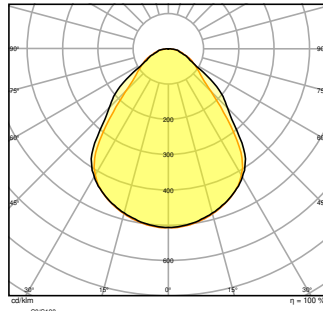
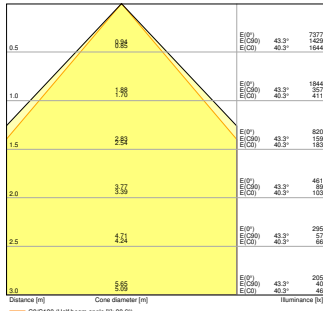
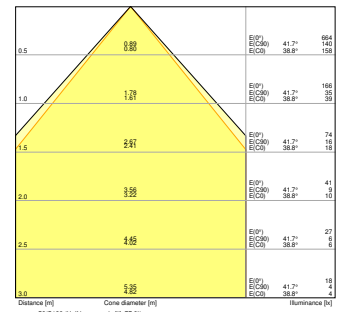
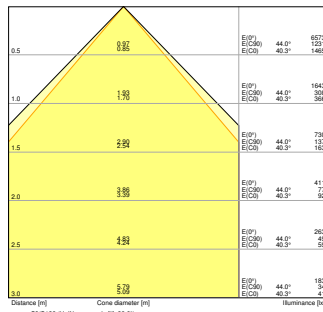
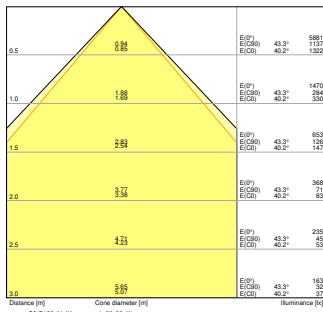

Dimensions & Weight

Length	595.00 mm
Width	595.00 mm
Height	32.00 mm
Product weight	1780.00 g

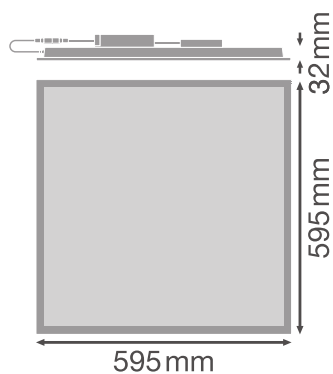

Materials & Colors

Product color	White
Housing color	White
Body material	Steel
Cover material	Polystyrene (PS)
Light emitting surface material	Polystyrene
Glow Wire Test according to IEC 60695-2-12	650 °C
Mercury content	0.0 mg

Application & Mounting

Ambient temperature range	-10...+50 °C
Temperature range at storage	-20...+80 °C
Type of connection	Screwless terminal, 5-Pole (L, N, PE, DA+, DA-)
Type of protection	IP40/IP20
Protection class IK (shock resistance)	IK02
Dimmable	No
Mounting type	Recessed/Suspended/Surface
Mounting location	Ceiling
Application environment	Indoor
Mounting length	575 mm
Mounting width	575 mm
Mounting depth	50,0 mm
Adjustable	No
LED module replaceable	Not replaceable
With light source	Yes

Lifespan

Lifespan L70/B50 at 25 °C	100000 h
Lifespan L80/B10 at 25 °C	70000 h
Lifespan L90/B10 at 25 °C	48000 h
Number of switching cycles	50000

Control gear

Output current	620 mA
ECG - Output ripple current	< 5 %
ECG - Length	143 mm
ECG - Width	49 mm
ECG - Height	30 mm
Recommended control gear	OSRAM OTI DALI 50/220-240/1A4 NFC; Tridonic LCA 45W 500-1400mA one4all SC PRE





Certificates & Standards

Standards	CE / CB / ENEC / UKCA / EAC
Luminaire with limited surface temperature, "D sign"	No
Ball shot safe	No







EQUIPMENT / ACCESSORIES

- Accessories for several mounting options available
- Connector box with 5-pole terminal included
- Security rope for luminaire included
- Security brackets preinstalled
- External control gear included
- Suitable for use with separate Emergency Conversion Box

DOWNLOAD DATA

Documents and certificates	
	User instruction
	Addon Technical Information
	Packaging insert
	Declarations Of Conformity CE

Photometric and lighting design files

	IES file (IES)
	LDT file (Eulumdat)
	ULD file (DIALux)
	ROLF file (RELUX)
	UGR file (UGR table)
	LDC typ cone
	LDC typ polar

CAD/BIM files

	BIM_Revit_3D
	CAD_STEP_3D

Tender texts

	Tender documents
---	------------------

LOGISTICAL DATA

Product code	Packaging unit (Pieces/Unit)	Dimensions (length x width x height)	Gross weight	Volume
4099854014628	Folding box 1	52 mm x 622 mm x 694 mm	2232.00 g	22.45 dm ³
4099854014635	Shipping box 4	647 mm x 222 mm x 724 mm	10808.00 g	103.99 dm ³

The mentioned product code describes the smallest quantity unit which can be ordered. One shipping unit can contain one or more single products. When placing an order, for the quantity please enter single or multiples of a shipping unit.

ADDITIONAL CATALOG INFORMATION

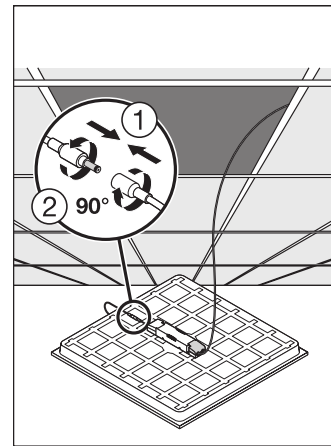
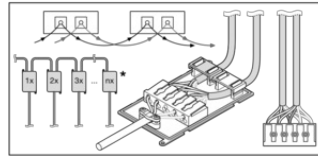
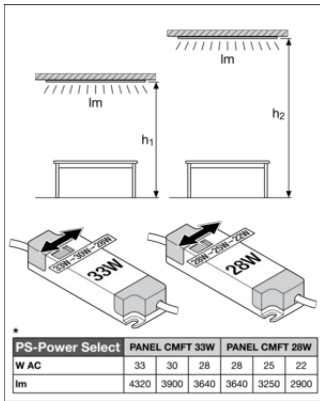

References / Links

- For Guarantee see www.ledvance.com/guarantee

DISCLAIMER

Subject to change without notice. Errors and omission excepted. Always make sure to use the most recent release.