

The server returned a "500 Internal Server Error".

Something is broken. Please let us know what you were doing when this error occurred. We will fix it as soon as possible. Sorry for any inconvenience caused.

PRODUCTINFORMATIEBLAD

DL UGR19 PFM DN195 21 W 840 WT IP54

DOWNLIGHT UGR19 | Downlights met lage verblinding, geschikt voor beeldschermwerkplekken



Toepassingsgebieden

- Geschikt voor kantoortoepassingen, met name voor beeldschermwerkplekken
- Directe vervanging voor armaturen met compact fluorescentielampen
- Ingangen / hallen
- Badkamers, keukens en werkplaatsen
- Algemene verlichting

Productvoordelen

- Goede verblindingsvermindering (UGR < 19) en afsnijhoek tot 30° voor comfortabele binnenverlichting
- Eenvoudige en snelle installatie dankzij de Connectorbox met 5-polige terminal
- Laag flikkeringsgehalte
- Geschikt voor gebruik in stoffige en vochtige ruimtes dankzij de hoge IP-classificatie
- 5 jaar garantie

Productkenmerken

- Materiaal behuizing: aluminium spiegelreflector
- Soort bescherming: IP54 (kamerzijde) / IP20 (achterzijde)
- Aansluitdoos met push-wire terminal voor gereedschapvrije aansluiting
- Doorvoerbedrading mogelijk
- Armatuurversies met IoT ready DALI-2 driver of IoT Zigbee 3.0 technologie beschikbaar

Oops! An Error Occurred

The server returned a "500 Internal Server Error".

Something is broken. Please let us know what you were doing when this error occurred. We will fix it as soon as possible. Sorry for any inconvenience caused.

The server returned a "500 Internal Server Error".

Something is broken. Please let us know what you were doing when this error occurred. We will fix it as soon as possible. Sorry for any inconvenience caused.

TECHNISCHE GEGEVENS

ELEKTRISCHE GEGEVENS

Nominale vermogen	21,00 W
Nominale spanning	220...240 V
Netfrequentie	50...60 Hz
Nominale stroom	120 mA
Inschakelstroom	30 A
Inschakelstroomtijd T_{h50}	200 μ s
Max. armaturen op stroomonderbreke B16 A	120
Max. armaturen op stroomonderbreke C10 A	80
Max. armaturen op stroomonderbreke C16 A	120
Arbeidsfactor λ	$\geq 0,90$
Totale harmonische vervorming	< 20 %
Veiligheidsklasse	II
Bedrijfsmodus	External LED driver

Fotometrische gegevens

Lichtstroom	2520 lm
Lichtstroom efficiëntie	120 lm/W
Kleurtemperatuur	4000 K
Lichtkleur	Koel wit
Kleurweergave-index Ra	≥ 80
Standaardafwijking van kleurproeven	≤ 5 sdc _m
Lichtsterkte	-
Flikkervrij	Ja
Flikkerwaarde Pst LM	-
Stroboscoopeffect waarde SVM	-
Fotobiologische veiligheidsgroep EN62778	RG1
Fotobiologische veiligheidsgroep EN62471	RG0
Stralingshoek	65 °
UGR longitudinal	< 19

Oops! An Error Occurred

The server returned a "500 Internal Server Error".

Something is broken. Please let us know what you were doing when this error occurred. We will fix it as soon as possible. Sorry for any inconvenience caused.

The server returned a "500 Internal Server Error".

Something is broken. Please let us know what you were doing when this error occurred. We will fix it as soon as possible. Sorry for any inconvenience caused.

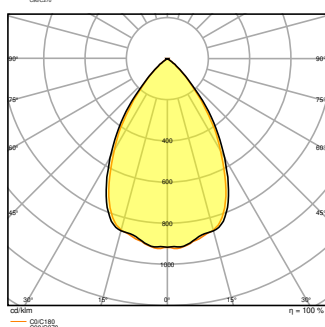
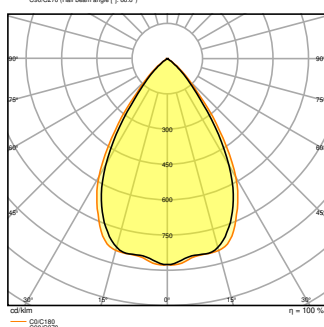
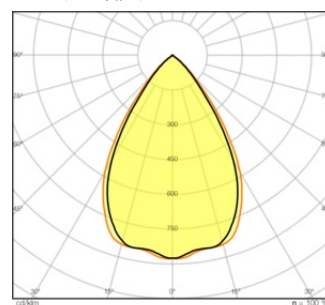
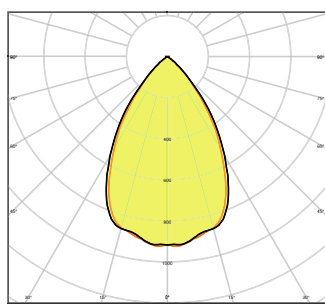
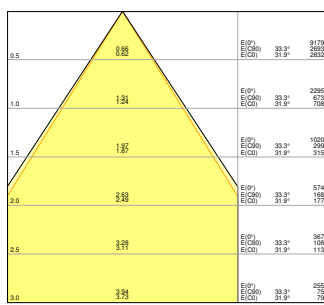
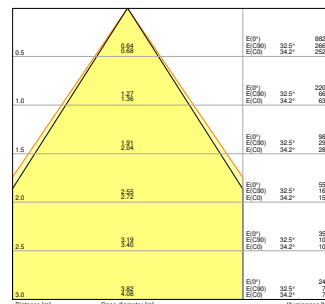
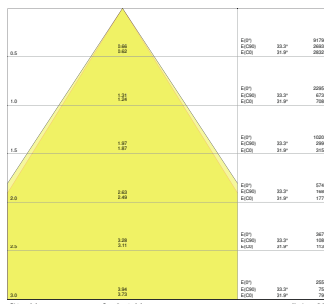

AFMETINGEN & GEWICHT

Diameter	220,00 mm
Hoogte	82,00 mm
Product gewicht	900,00 g

choose one

Country

[myLEDVANCE](#)

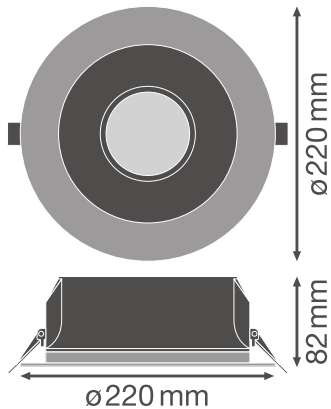

MATERIALEN & KLEUREN

Kleur van het product	Wit
Kleur behuizing	Wit
Body materiaal	Aluminium
Materiaal afdekking	Polycarbonate (PC)
Materiaal van lichtuitstralend oppervlak	Polycarbonaat
Glow Wire Test volgens IEC 60695-2-12	650 °C
Kwikgehalte	0.0 mg

TOEPASSING & MONTAGE

Omgevingstemperatuur bereik	-20...+45 °C
Opslagtemperatuur	-40...+70 °C
Type aansluiting	Schroefloze terminal
Type bescherming	IP54/IP20
Beschermklasse IK (Schok bestendi [PIM])	IK03
Dimbaar	Nee
Montagetype	Recessed
Montagelocatie	Plafond
Toepassingsomgeving	Indoor
Diameter inbouw opening	195,0 mm
Inbouwdiepte	120 mm
Vervangbare LED module	Niet vervangbaar
Met lichtbron	Ja

Levensduur

Oops! An Error Occurred

The server returned a "500 Internal Server Error".

Something is broken. Please let us know what you were doing when this error occurred. We will fix it as soon as possible. Sorry for any inconvenience caused.

Levensduur L70/B50 @ 25 °C	70000 h
Levensduur L80/B10 @ 25 °C	60000 h
Levensduur L90/B10 @ 25 °C	40000 h
Aantal schakelcycli	100000

VOORSCHAKELAPPARATUUR

Uitgangsstroom:	700 mA
E-VSA - Uitgangsrimpelstroom	< 10 %
E-VSA - Lengte	114.0 mm
E-VSA - Breedte	45 mm
ECG - Hoogte	28 mm
Aanbevolen voorschakelapparatuur	OSRAM OTI DALI 50/220-240/1A4 NFC

CERTIFICATEN & NORMEN

Normen	CE / CB / ENEC / TÜV SÜD / EAC
Gelimiteerde oppervlaktetemperatuur	Nee
Balschot veilig	Nee





AANVULLENDE PRODUCTGEGEVENS

Aantal inbegrepen lichtbronnen	Not relevant
--------------------------------	--------------

Technische uitrusting

- Extern voorschakelapparaat inbegrepen

DOWNLOADS

Documenten en certificaten	
	User instruction
	Addon Technical Information
	Packaging insert
	Declarations Of Conformity CE
	Declarations Of Conformity UKCA

The server returned a "500 Internal Server Error".

Something is broken. Please let us know what you were doing when this error occurred. We will fix it as soon as possible. Sorry for any inconvenience caused.



IES file (IES)



LDT file (Eulumdat)



ULD file (DIALux)



ROLF file (RELUX)



UGR file (UGR table)



LDC typ cone



LDC typ polar

CAD/BIM-bestanden



BIM_Revit_3D



CAD_STEP_3D

Aanbestedingsteksten



Tender documenten

LOGISTIEKE GEGEVENS

Productcode	Verpakkingseenheid (stuks per verpakking)	Afmetingen (lengte x breedte x hoogte)	Brutogewicht	Volume
4058075459274	Vouwdoos 1	262 mm x 108 mm x 266 mm	1197.00 g	7.53 dm ³
4058075459281	Verzenddoos 16	545 mm x 452 mm x 563 mm	20749.00 g	138.69 dm ³

De genoemde productcodes beschrijven de kleinste hoeveelheid die besteld kan worden. Eén verzendeenheid kan bestaan uit één of meer afzonderlijke producten. Bij het plaatsen van een order enkele of veelvoud van de verpakkingseenheid invoeren.

AANVULLENDE CATALOGUSINFORMATIE

choose one

Country

[myLEDVANCE](#)

The server returned a "500 Internal Server Error".

Something is broken. Please let us know what you were doing when this error occurred. We will fix it as soon as possible. Sorry for any inconvenience caused.

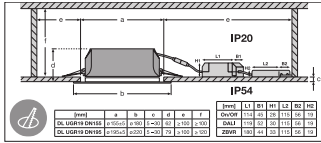
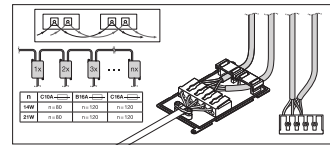
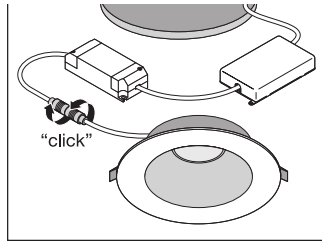
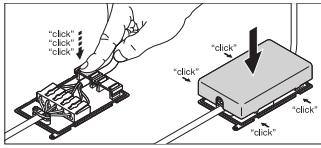

Referenties / Links

– Voor garantie zie www.benelux.ledvance.com/garantie

DISCLAIMER

Onder voorbehoud van verandering zonder kennisgeving. Fouten en drukfouten voorbehouden. Zorg ervoor dat u de meest recente versie gebruikt.