

PRODUCTINFORMATIEBLAD

DL COMFORT DN 155 18 W 3CCT IP54 WT

DOWNLIGHT COMFORT | Downlights met regelbare witte lichtkleuren



Toepassingsgebieden

- Directe vervanging voor armaturen met compact fluorescentielampen
- Algemene verlichting
- Badkamers
- Keukens
- Kantoren
- Gangen
- Foyers
- Winkels
- Trappenhuizen

Productvoordelen

- Three light color in one luminaire: Warm White, Cool White, Daylight White
- Eenvoudige installatie dankzij geïntegreerde driver
- Eenvoudige installatie met snelle aansluiting
- 5 jaar garantie

Productkenmerken

- Drie lichtkleuren selecteerbaar via schuifschakelaar
- IP-code: IP54
- Aansluitdoos met push-wire terminal voor gereedschapvrije aansluiting
- Doorvoerbedrading mogelijk

Oops! An Error Occurred

The server returned a "500 Internal Server Error".

Something is broken. Please let us know what you were doing when this error occurred. We will fix it as soon as possible. Sorry for any inconvenience caused.

TECHNISCHE GEGEVENS

ELEKTRISCHE GEGEVENS

Nominale vermogen	18,00 W
Nominale spanning	100...277 V
Netfrequentie	50...60 Hz
Nominale stroom	200 mA
Inschakelstroom	55 A
Inschakelstroomtijd T_{h50}	100 μ s
Max. armaturen op stroomonderbreke B16 A	15
Max. armaturen op stroomonderbreke C10 A	12
Max. armaturen op stroomonderbreke C16 A	19
Arbeidsfactor λ	> 0,90
Totale harmonische vervorming	< 20 %
Veiligheidsklasse	I
Bedrijfsmodus	Integrated LED driver

Fotometrische gegevens

Lichtstroom	1040...1620 lm ¹⁾
Lichtstroom efficiëntie	85 lm/W ²⁾
Kleurtemperatuur	3000...5700 K
Lichtkleur	Warm White / Koel wit / Koel daglicht
Kleurweergave-index Ra	> 80
Standaardafwijking van kleurproeven	< 5 sdc _m
Lichtsterkte	-
Flikkerwaarde Pst LM	-
Stroboscoopeffect waarde SVM	-
Fotobiologische veiligheidsgroep EN62778	RG0
Fotobiologische veiligheidsgroep EN62471	RG0
Stralingshoek	60 °
UGR longitudinal	< 22

¹⁾ Lichtstroom afhankelijk van geselecteerde kleurtemperatuur: 1040 lm@3000K/1620 lm@4000K/1470 lm@5700K

²⁾ Waarde bij 5700 K, verschillend voor andere kleurtemperaturen

Oops! An Error Occurred

The server returned a "500 Internal Server Error".

Something is broken. Please let us know what you were doing when this error occurred. We will fix it as soon as possible. Sorry for any inconvenience caused.

The server returned a "500 Internal Server Error".

Something is broken. Please let us know what you were doing when this error occurred. We will fix it as soon as possible. Sorry for any inconvenience caused.

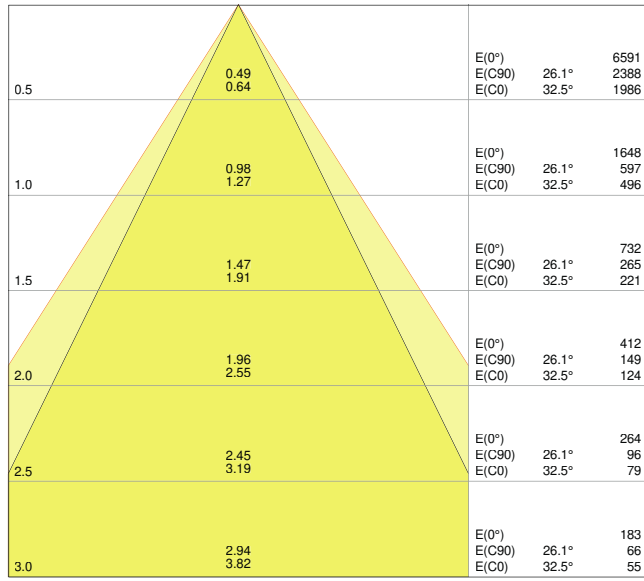

LDC typ cone

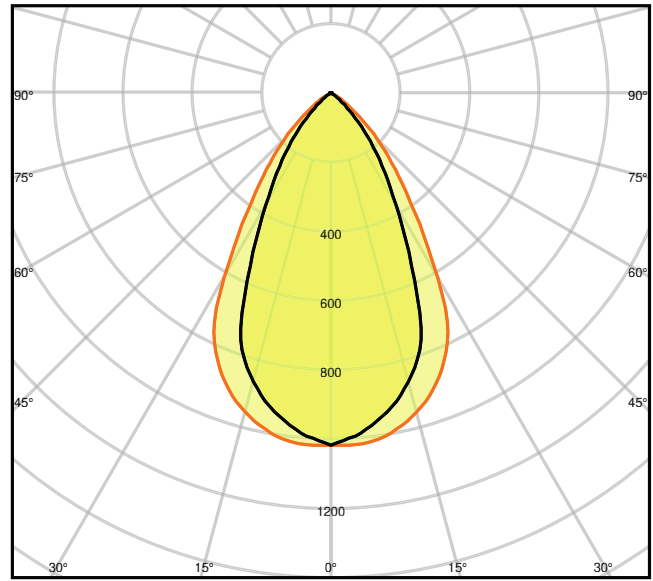

LDC typ polar

AFMETINGEN & GEWICHT

Diameter	172,00 mm
Hoogte	95.00 mm
Product gewicht	350,00 g

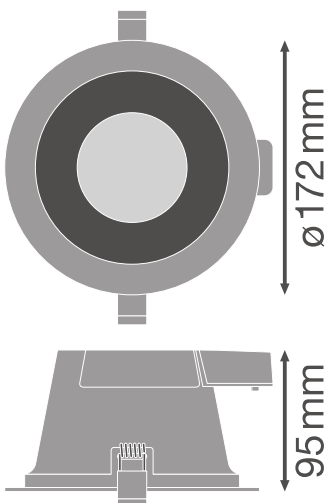

Oops! An Error Occurred

The server returned a "500 Internal Server Error".

Something is broken. Please let us know what you were doing when this error occurred. We will fix it as soon as possible. Sorry for any inconvenience caused.

The server returned a "500 Internal Server Error".

Something is broken. Please let us know what you were doing when this error occurred. We will fix it as soon as possible. Sorry for any inconvenience caused.

MATERIALEN & KLEUREN

Kleur van het product	Wit
Kleur behuizing	Wit
Body materiaal	Aluminum
Materiaal afdekking	Polymethylmethacrylate (PMMA)
Glow Wire Test volgens IEC 60695-2-12	650 °C
Kwikgehalte	0.0 mg

TOEPASSING & MONTAGE

Omgevingstemperatuur bereik	-20...+45 °C
Type aansluiting	Schroefloze terminal, 2-polig
Type bescherming	IP54/IP20
Beschermklasse IK (Schok bestendi [PIM])	IK03
Dimbaar	Nee
Montagetype	Recessed
Montagelocatie	Plafond
Toepassingsomgeving	Indoor
Diameter inbouw opening	155,0 mm
Inbouwdiepte	125 mm
Vervangbare LED module	Niet vervangbaar
Met lichtbron	Ja

Levensduur

Levensduur L70/B50 @ 25 °C	50000 h
Levensduur L80/B10 @ 25 °C	43000 h
Levensduur L90/B10 @ 25 °C	30000 h
Aantal schakelcycli	50000

CERTIFICATEN & NORMEN

Normen	CE / CB / ENEC / TÜV SÜD
Gelimiteerde oppervlaktetemperatuur	Nee
Balschot veilig	Nee

AANVULLENDE PRODUCTGEGEVENS

Aantal inbegrepen lichtbronnen	Not relevant
--------------------------------	--------------













Oops! An Error Occurred

The server returned a "500 Internal Server Error".

Something is broken. Please let us know what you were doing when this error occurred. We will fix it as soon as possible. Sorry for any inconvenience caused.

The server returned a "500 Internal Server Error".

Something is broken. Please let us know what you were doing when this error occurred. We will fix it as soon as possible. Sorry for any inconvenience caused.

Documenten en certificaten	
	User instruction
	Addon Technical Information
	Packaging insert
	Declarations Of Conformity CE
	Declarations Of Conformity UKCA
Fotometrische- en lichtontwerpbestanden	
	IES file (IES)
	LDT file (Eulumdat)
	ULD file (DIALux)
	ROLF file (RELUX)
	UGR file (UGR table)
	LDC typ cone
	LDC typ polar
Aanbestedingsteksten	
	Tender documenten

LOGISTIEKE GEGEVENS

Productcode	Verpakkingseenheid (stuks per verpakking)	Afmetingen (lengte x breedte x hoogte)	Brutogewicht	Volume
4058075104082	Vouwdoos 1	195 mm x 195 mm x 140 mm	430.00 g	5.32 dm ³
4058075104099	Verzenddoos 8	410 mm x 410 mm x 300 mm	4760.00 g	50.43 dm ³

De genoemde productcodes beschrijven de kleinste hoeveelheid die besteld kan worden. Eén verzendeenheid kan bestaan uit één of meer afzonderlijke producten. Bij het plaatsen van een order enkele of veelvoud van de verpakkingseenheid invoeren.

Oops! An Error Occurred

The server returned a "500 Internal Server Error".

Something is broken. Please let us know what you were doing when this error occurred. We will fix it as soon as possible. Sorry for any inconvenience caused.

The server returned a "500 Internal Server Error".

Something is broken. Please let us know what you were doing when this error occurred. We will fix it as soon as possible. Sorry for any inconvenience caused.

AANVULLENDE CATALOGUSINFORMATIE

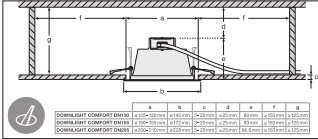
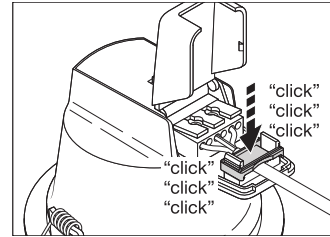
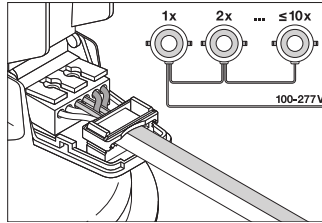
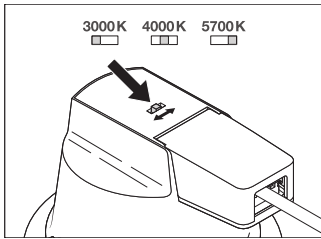

Referenties / Links

- Voor garantie zie www.benelux.ledvance.com/garantie

DISCLAIMER

Onder voorbehoud van verandering zonder kennisgeving. Fouten en drukfouten voorbehouden. Zorg ervoor dat u de meest recente versie gebruikt.

Oops! An Error Occurred

The server returned a "500 Internal Server Error".

Something is broken. Please let us know what you were doing when this error occurred. We will fix it as soon as possible. Sorry for any inconvenience caused.