

PRODUCT DATASHEET

PL CMFT 600 P 33W 840 PS

PANEL COMFORT 600 PS | Square recessed panel luminaires with power select (PS) feature, for 600 x 600 mm ceiling systems



Areas of application

- Direct replacement for recessed luminaires with fluorescent lamps
- Offices, conference rooms
- Reception areas, foyers, corridors, elevators
- Suitable for recessed ceiling systems with grid size of 600 x 600 mm

Product benefits

- Highly versatile due to selectable power steps (Power Select - PS) on the driver
- Tool-free electrical connection due to push button connector
- Through-wiring possible with included connector box
- Energy savings thanks to high system efficacy: up to 130 lm/W
- High color consistency with SDCM 3
- Extended services such as energy monitoring and remote maintenance possible with DALI versions
- External driver for extended flexibility and easy installation
- Low flicker light thanks to special electronic control gear
- Emergency lighting possible with LEDVANCE Emergency Conversion Box
- 5 years guarantee

Product features

- Extruded aluminum frame
- Polystyrene diffuser



- 5-pole terminal block, cable cross section up to 5 x 2.5 mm²
- Luminaire versions with IoT-ready DALI-2 driver available
- Lifetime (L80/B10): 70,000 h (at 25 °C)

TECHNICAL DATA

Electrical data

| | |
|---|----------------------------------|
| Nominal wattage | 33 W / 30 W / 28 W ¹⁾ |
| Nominal voltage | 220...240 V |
| Mains frequency | 50...60 Hz |
| Nominal current | 150.000 mA |
| Inrush current | 9 A |
| Inrush current time T _{h50} | 690 µs |
| Max. number of luminaires per miniature circuit breaker B16 | 14 |
| Max. number of luminaires per miniature circuit breaker C10 | 15 |
| Max. number of luminaires per miniature circuit breaker C16 | 24 |
| Power factor λ | > 0.90 |
| Total harmonic distortion | < 20 % |
| Protection class | II |
| Operating mode | External LED driver |

¹⁾ For possible options refer to lumen/power table image / CRI80 versions of the Panel Comfort family are fulfilling the technical minimum requirements according to the German BEG subsidy program for energy efficient luminaires

Photometrical data

| | |
|--|---|
| Luminous flux | 4320 lm / 3900 lm / 3640 lm ¹⁾ |
| Luminous efficacy | 130 lm/W ¹⁾ |
| Color temperature | 4000 K |
| Light color (designation) | Cool White |
| Color rendering index Ra | > 80 |
| Standard deviation of color matching | ≤3 sdc _m |
| Low flicker | Yes |
| Flickering metric (Pst LM) | <1 |
| Stroboscope effect metric (SVM) | < 0.4 |
| Photobiological safety group acc. to EN62778 | RG0 |
| Beam angle | 110 ° |

¹⁾ For possible options refer to lumen/power table image / CRI80 versions of the Panel Comfort family are fulfilling the technical minimum requirements according to the German BEG subsidy program for energy efficient luminaires

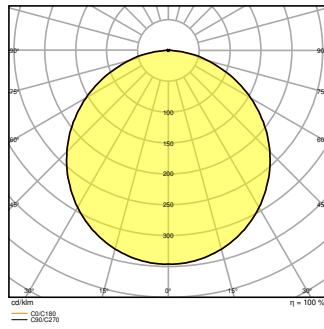
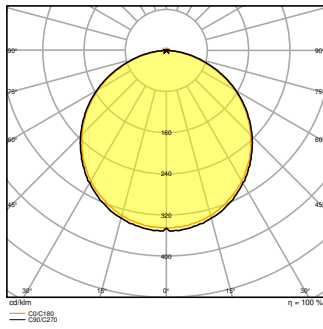
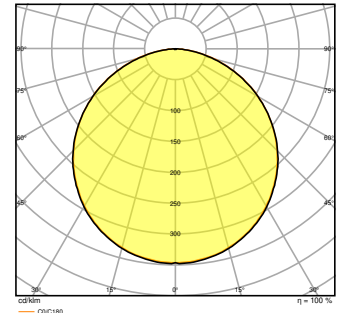
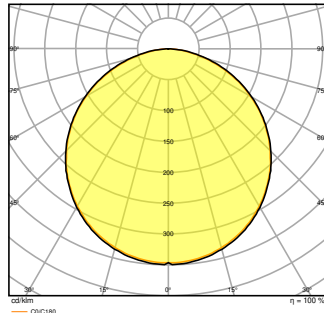
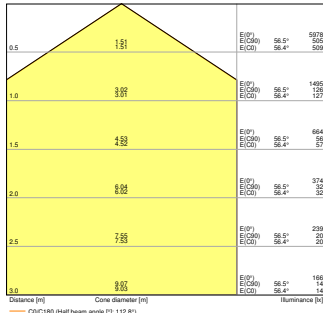
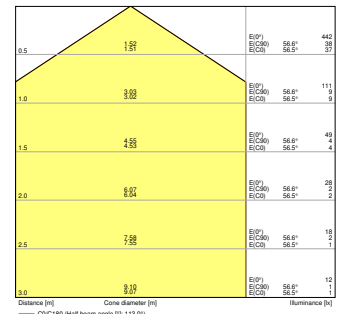
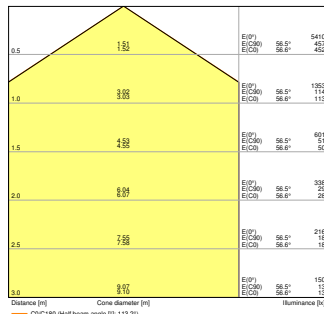
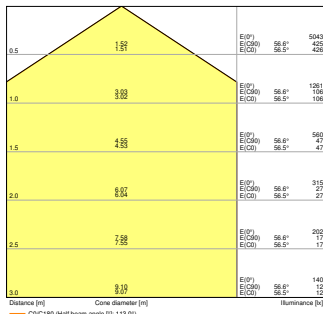

Dimensions & Weight

| | |
|----------------|-----------|
| Length | 595.00 mm |
| Width | 595.00 mm |
| Height | 32.00 mm |
| Product weight | 1600.00 g |

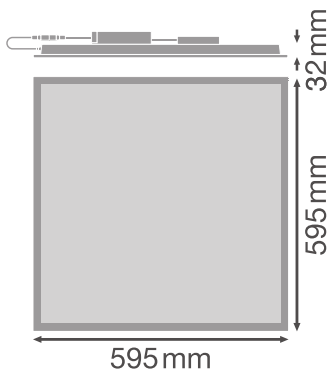

Materials & Colors

| | |
|--|------------------|
| Product color | White |
| Housing color | White |
| Body material | Steel |
| Cover material | Polystyrene (PS) |
| Light emitting surface material | Polystyrene |
| Glow Wire Test according to IEC 60695-2-12 | 650 °C |
| Mercury content | 0.0 mg |

Application & Mounting

| | |
|--|---|
| Ambient temperature range | -10...+50 °C |
| Temperature range at storage | -20...+80 °C |
| Type of connection | Screwless terminal, 5-Pole (L, N, PE, DA+, DA-) |
| Type of protection | IP40/IP20 |
| Protection class IK (shock resistance) | IK02 |
| Dimmable | No |
| Mounting type | Recessed/Suspended/Surface |
| Mounting location | Ceiling |
| Application environment | Indoor |
| Mounting length | 575 mm |
| Mounting width | 575 mm |
| Mounting depth | 50,0 mm |
| Adjustable | No |
| LED module replaceable | Not replaceable |
| With light source | Yes |

Lifespan

| | |
|----------------------------|------------------------|
| Lifespan L70/B50 at 25 °C | 100000 h ¹⁾ |
| Lifespan L80/B10 at 25 °C | 70000 h ¹⁾ |
| Lifespan L90/B10 at 25 °C | 48000 h |
| Number of switching cycles | 50000 |

¹⁾ t[h]: L70 / B50 @ 25 °C (Ta), t[h]: L80 / B10 @ 25 °C (Ta), t[h]: L90 / B10 @ 25 °C (Ta)

Control gear

| | |
|-----------------------------|---|
| Output current | 730 mA |
| ECG - Output ripple current | < 5 % |
| ECG - Length | 143 mm |
| ECG - Width | 49 mm |
| ECG - Height | 30 mm |
| Recommended control gear | OSRAM OTI DALI 50/220-240/1A4 NFC; Tridonic LCA 45W 500-1400mA one4all SC PRE |



Certificates & Standards

| | |
|--|-----------------------------------|
| Standards | CE / CB / ENEC / UKCA / EAC / EPD |
| Luminaire with limited surface temperature, "D sign" | No |
| Ball shot safe | No |
| EPD | LEDV-00011-V01.01-EN |



EQUIPMENT / ACCESSORIES

- Accessories for several mounting options available
- Connector box with 5-pole terminal included
- Security rope for luminaire included
- Security brackets preinstalled
- External control gear included
- Suitable for use with separate Emergency Conversion Box



DOWNLOAD DATA

| Documents and certificates | |
|--|-----------------------------|
|  | User instruction |
|  | Addon Technical Information |

Documents and certificates

| | |
|--|---------------------------------|
|  | Declarations Of Conformity CE |
|  | Declarations Of Conformity UKCA |
|  | PEP Ecopassport |

Photometric and lighting design files

| | |
|--|----------------------|
|  | IES file (IES) |
|  | LDT file (Eulumdat) |
|  | ULD file (DIALux) |
|  | ROLF file (RELUX) |
|  | UGR file (UGR table) |
|  | LDC typ cone |
|  | LDC typ polar |

CAD/BIM files

| | |
|--|--------------|
|  | BIM_Revit_3D |
|  | CAD_STEP_3D |

LOGISTICAL DATA

| Product code | Packaging unit (Pieces/Unit) | Dimensions (length x width x height) | Gross weight | Volume |
|---------------|------------------------------|--------------------------------------|--------------|------------------------|
| 4099854014888 | Folding box 1 | 52 mm x 622 mm x 694 mm | 2055.00 g | 22.45 dm ³ |
| 4099854014895 | Shipping box 4 | 647 mm x 222 mm x 724 mm | 9302.00 g | 103.99 dm ³ |

The mentioned product code describes the smallest quantity unit which can be ordered. One shipping unit can contain one or more single products. When placing an order, for the quantity please enter single or multiples of a shipping unit.

ADDITIONAL CATALOG INFORMATION

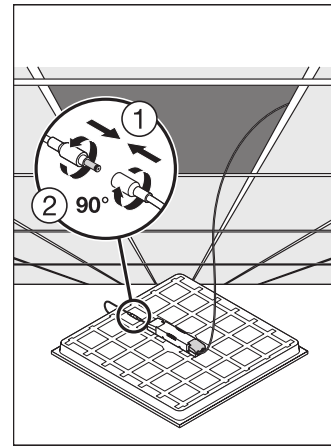
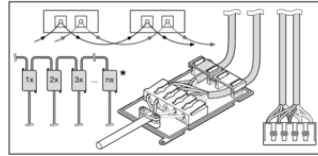
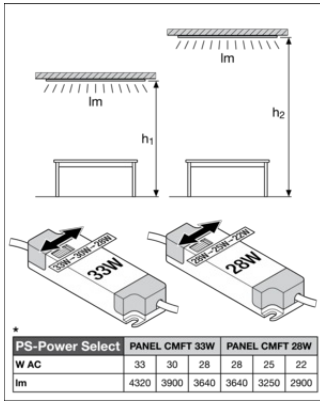

References / Links

– For Guarantee see www.ledvance.com/guarantee

DISCLAIMER

Subject to change without notice. Errors and omission excepted. Always make sure to use the most recent release.