

# Product datasheet

Specifications



## variable speed drive ATV12 - 0.18kW - 0.25hp - 200..240V - 1ph

Local distributor code:

392951524

ATV12H018M2

**EAN Code: 3606480071089**

### Main

Range of product	Altivar 12
Product or component type	Variable speed drive
Product specific application	Simple machine
Mounting mode	Cabinet mount
Communication port protocol	Modbus
Supply frequency	50/60 Hz +/- 5 %
[Us] rated supply voltage	200...240 V - 15...10 %
Nominal output current	1.4 A
Motor power kW	0.18 kW
Motor power hp	0.25 hp
EMC filter	Integrated
IP degree of protection	IP20
Motor power hp	0.25 hp

### Complementary

Discrete input number	4
Discrete output number	2
Analogue input number	1
Analogue output number	1
Relay output number	1
Physical interface	2-wire RS 485
Connector type	1 RJ45
Continuous output current	1.4 A at 4 kHz
Method of access	Server Modbus serial
Speed drive output frequency	0.5...400 Hz
Speed range	1...20
Sampling duration	20 ms, tolerance +/- 1 ms for logic input 10 ms for analogue input
Linearity error	+/- 0.3 % of maximum value for analogue input
Frequency resolution	Analog input: converter A/D, 10 bits Display unit: 0.1 Hz
Time constant	20 ms +/- 1 ms for reference change

<b>Transmission rate</b>	9.6 kbit/s 19.2 kbit/s 38.4 kbit/s
<b>Transmission frame</b>	RTU
<b>Number of addresses</b>	1...247
<b>Data format</b>	8 bits, configurable odd, even or no parity
<b>Communication service</b>	Read holding registers (03) 29 words Write single register (06) 29 words Write multiple registers (16) 27 words Read/write multiple registers (23) 4/4 words Read device identification (43)
<b>Type of polarization</b>	No impedance
<b>4 quadrant operation possible</b>	False
<b>Asynchronous motor control profile</b>	Voltage/frequency ratio (V/f) Sensorless flux vector control Quadratic voltage/frequency ratio
<b>Maximum output frequency</b>	4 kHz
<b>Transient overtorque</b>	150...170 % of nominal motor torque depending on drive rating and type of motor
<b>Acceleration and deceleration ramps</b>	U Linear from 0 to 999.9 s S
<b>Motor slip compensation</b>	Preset in factory Adjustable
<b>Switching frequency</b>	2...16 kHz adjustable 4...16 kHz with derating factor
<b>Nominal switching frequency</b>	4 kHz
<b>Braking to standstill</b>	By DC injection
<b>Brake chopper integrated</b>	False
<b>Line current</b>	3.4 A at 100 V (heavy duty) 2.8 A at 120 V (heavy duty)
<b>Maximum input current</b>	2.8 A
<b>Maximum output voltage</b>	240 V
<b>Apparent power</b>	0.7 kVA at 240 V (heavy duty)
<b>Maximum transient current</b>	2.1 A during 60 s (heavy duty) 2.3 A during 2 s (heavy duty)
<b>Network frequency</b>	50...60 Hz
<b>Relative symmetric network frequency tolerance</b>	5 %
<b>Prospective line I<sub>sc</sub></b>	1 kA
<b>Base load current at high overload</b>	1.4 A
<b>Power dissipation in W</b>	Natural: 18.0 W
<b>With safety function Safely Limited Speed (SLS)</b>	False
<b>With safety function Safe brake management (SBC/SBT)</b>	False
<b>With safety function Safe Operating Stop (SOS)</b>	False
<b>With safety function Safe Position (SP)</b>	False
<b>With safety function Safe programmable logic</b>	False
<b>With safety function Safe Speed Monitor (SSM)</b>	False

<b>With safety function Safe Stop 1 (SS1)</b>	False
<b>With sft fct Safe Stop 2 (SS2)</b>	False
<b>With safety function Safe torque off (STO)</b>	False
<b>With safety function Safely Limited Position (SLP)</b>	False
<b>With safety function Safe Direction (SDI)</b>	False
<b>Protection type</b>	Line supply overvoltage Line supply undervoltage Overcurrent between output phases and earth Overheating protection Short-circuit between motor phases Against input phase loss in three-phase Thermal motor protection via the drive by continuous calculation of I <sup>2</sup> t
<b>tightening torque</b>	0.8 N.m
<b>Insulation</b>	Electrical between power and control
<b>Quantity per set</b>	Set of 1
<b>Width</b>	72 mm
<b>Height</b>	143 mm
<b>Depth</b>	102.2 mm
<b>Net weight</b>	0.7 kg

## Environment

<b>Operating altitude</b>	> 1000...2000 m with current derating 1 % per 100 m <= 1000 m without derating
<b>Operating position</b>	Vertical +/- 10 degree
<b>Product certifications</b>	NOM CSA C-Tick UL GOST RCM KC
<b>Marking</b>	CE
<b>Standards</b>	UL 508C UL 618000-5-1 IEC 61800-5-1 IEC 61800-3
<b>Assembly style</b>	On base plate
<b>Electromagnetic compatibility</b>	Electrical fast transient/burst immunity test level 4 conforming to IEC 61000-4-4 Electrostatic discharge immunity test level 3 conforming to IEC 61000-4-2 Immunity to conducted disturbances level 3 conforming to IEC 61000-4-6 Radiated radio-frequency electromagnetic field immunity test level 3 conforming to IEC 61000-4-3 Surge immunity test level 3 conforming to IEC 61000-4-5 Voltage dips and interruptions immunity test conforming to IEC 61000-4-11
<b>Environmental class (during operation)</b>	Class 3C3 according to IEC 60721-3-3 Class 3S2 according to IEC 60721-3-3
<b>Maximum acceleration under shock impact (during operation)</b>	150 m/s <sup>2</sup> at 11 ms
<b>Maximum acceleration under vibrational stress (during operation)</b>	10 m/s <sup>2</sup> at 13...200 Hz
<b>Maximum deflection under vibratory load (during operation)</b>	1.5 mm at 2...13 Hz
<b>Overvoltage category</b>	Class III
<b>Regulation loop</b>	Adjustable PID regulator

<b>Electromagnetic emission</b>	Radiated emissions environment 1 category C2 conforming to IEC 61800-3 2...16 kHz shielded motor cable Conducted emissions with integrated EMC filter environment 1 category C1 conforming to IEC 61800-3 2, 4, 8, 12 and 16 kHz shielded motor cable <5 m Conducted emissions with integrated EMC filter environment 1 category C2 conforming to IEC 61800-3 2...12 kHz shielded motor cable <5 m Conducted emissions with integrated EMC filter environment 1 category C2 conforming to IEC 61800-3 2, 4 and 16 kHz shielded motor cable <10 m Conducted emissions with additional EMC filter environment 1 category C1 conforming to IEC 61800-3 4...12 kHz shielded motor cable <20 m Conducted emissions with additional EMC filter environment 1 category C2 conforming to IEC 61800-3 4...12 kHz shielded motor cable <50 m Conducted emissions with additional EMC filter environment 2 category C3 conforming to IEC 61800-3 4...12 kHz shielded motor cable <50 m
<b>Vibration resistance</b>	1 gn (f = 13...200 Hz) conforming to IEC 60068-2-6 1.5 mm peak to peak (f = 3...13 Hz) - drive unmounted on symmetrical DIN rail - conforming to IEC 60068-2-6
<b>Shock resistance</b>	15 gn conforming to IEC 60068-2-27 for 11 ms
<b>Relative humidity</b>	5...95 % without condensation conforming to IEC 60068-2-3 5...95 % without dripping water conforming to IEC 60068-2-3
<b>Noise level</b>	0 dB
<b>Pollution degree</b>	2
<b>Ambient air transport temperature</b>	-25...70 °C
<b>Ambient air temperature for operation</b>	-10...40 °C without derating 40...60 °C with current derating 2.2 % per °C
<b>Ambient air temperature for storage</b>	-25...70 °C

## Packing Units

<b>Unit Type of Package 1</b>	PCE
<b>Number of Units in Package 1</b>	1
<b>Package 1 Height</b>	11.500 cm
<b>Package 1 Width</b>	18.600 cm
<b>Package 1 Length</b>	19.500 cm
<b>Package 1 Weight</b>	887.000 g
<b>Unit Type of Package 2</b>	S06
<b>Number of Units in Package 2</b>	45
<b>Package 2 Height</b>	75.000 cm
<b>Package 2 Width</b>	60.000 cm
<b>Package 2 Length</b>	80.000 cm
<b>Package 2 Weight</b>	52.780 kg

## Logistical informations

<b>Country of origin</b>	ID
--------------------------	----

## Contractual warranty

<b>Warranty</b>	18 months
-----------------	-----------





## Environmental Data

Schneider Electric aims to achieve Net Zero status by 2050 through supply chain partnerships, lower impact materials, and circularity via our ongoing “Use Better, Use Longer, Use Again” campaign to extend product lifetimes and recyclability.



[Environmental Data explained >](#)

[How we assess product sustainability >](#)

### Use Better

 <b>Materials and Substances</b>	
Packaging made with recycled cardboard	Yes
Packaging without single use plastic	Yes
<a href="#">EU RoHS Directive</a>	Pro-active compliance (Product out of EU RoHS legal scope)
SCIP Number	488b1fd0-df04-41cb-85a8-34a5a8230847
REACH Regulation	<a href="#">REACH Declaration</a>
 <b>Energy efficiency</b>	
Product contributes to saved and avoided emissions	Yes

### Use Again

 <b>Repack and remanufacture</b>	
End of life manual availability	<a href="#">End of Life Information</a>
Take-back	No
WEEE Label	 The product must be disposed on European Union markets following specific waste collection and never end up in rubbish bins

Dimensions Drawings

Dimensions

Drive without EMC Conformity Kit

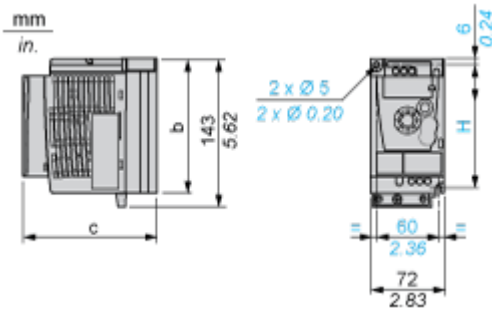

Dimensions in mm

b	c	H
142	102.2	131

Dimensions in in.

b	c	H
5.59	4.02	5.16

Drive with EMC Conformity Kit

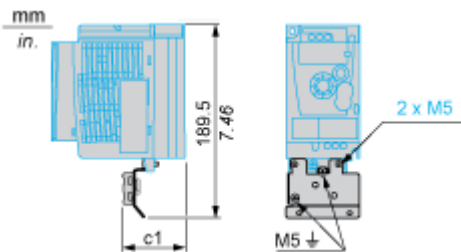

Dimensions in mm

c1
34

Dimensions in in.

c1
1.34

Mounting and Clearance

Mounting Recommendations

Clearance for Vertical Mounting



Mounting Type A



Mounting Type B



Remove the protective cover from the top of the drive.

Mounting Type C



Remove the protective cover from the top of the drive.

Connections and Schema

Single-Phase Power Supply Wiring Diagram



A1 Drive

KM1 Contactor (only if a control circuit is needed)

P1 2.2 kΩ reference potentiometer. This can be replaced by a 10 kΩ potentiometer (maximum).

Q1 Circuit breaker

(1) Negative logic (Sink)

(2) Positive logic (Source) (factory set configuration)

(3) 0...10 V or 0...20 mA

Recommended Schemes

---

2-Wire Control for Logic I/O with Internal Power Supply



- LI1 : Forward
- LI• : Reverse
- A1 : Drive

3-Wire Control for Logic I/O with Internal Power Supply



- LI1 : Stop
- LI2 : Forward
- LI• : Reverse
- A1 : Drive

Analog Input Configured for Voltage with Internal Power Supply



- (1) 2.2 kΩ...10 kΩ reference potentiometer
- A1 : Drive

Analog Input Configured for Current with Internal Power Supply



- (2) 0-20 mA 4-20 mA supply
- A1 : Drive

Connected as Positive Logic (Source) with External 24 vdc Supply

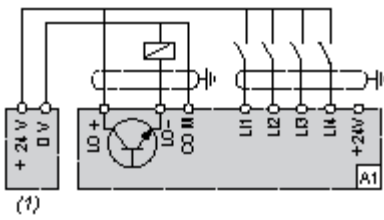

(1) 24 vdc supply

A1 : Drive

Connected as Negative Logic (Sink) with External 24 vdc supply

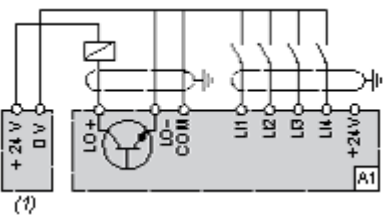

(1) 24 vdc supply

A1 : Drive

Performance Curves

Torque Curves

---

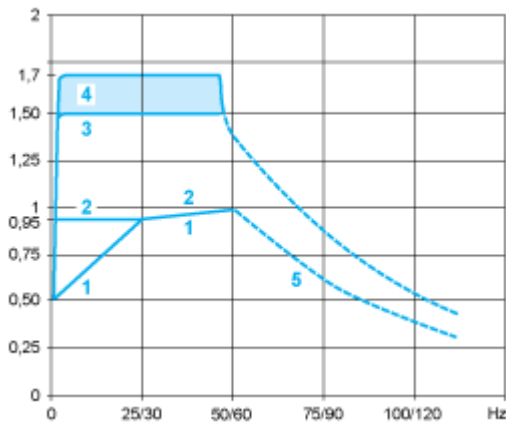

- 1 : Self-cooled motor: continuous useful torque **(1)**
- 2 : Force-cooled motor: continuous useful torque
- 3 : Transient overtorque for 60 s
- 4 : Transient overtorque for 2 s
- 5 : Torque in overspeed at constant power **(2)**

(1) For power ratings ≤ 250 W, derating is 20% instead of 50% at very low frequencies.

(2) The nominal motor frequency and the maximum output frequency can be adjusted from 0.5 to 400 Hz. The mechanical overspeed capability of the selected motor must be checked with the manufacturer.

Image of product / Alternate images

Alternative

---



