

Product datasheet

Specifications



Motor circuit breaker, TeSys GV2, 3P, 1-1.6 A, thermal magnetic, screw clamp terminals

Local distributor code:

381796952

GV2ME06

EAN Code: 3389110343052

Main

Range	TeSys Deca
Product name	TeSys GV2
Product or component type	Motor circuit breaker
Device short name	GV2ME
Device application	Motor protection
Trip unit technology	Thermal-magnetic

Complementary

Poles description	3P
Network type	AC
Utilisation category	Category A conforming to IEC 60947-2 AC-3 conforming to IEC 60947-4-1 AC-3e conforming to IEC 60947-4-1
Network frequency	50/60 Hz conforming to IEC 60947-2
Motor power kW	0.37 kW at 400/415 V AC 50/60 Hz 0.55 kW at 400/415 V AC 50/60 Hz 0.37 kW at 500 V AC 50/60 Hz 0.55 kW at 500 V AC 50/60 Hz 0.75 kW at 500 V AC 50/60 Hz 0.75 kW at 690 V AC 50/60 Hz 1.1 kW at 690 V AC 50/60 Hz
Breaking capacity	100 kA Icu at 230/240 V AC 50/60 Hz conforming to IEC 60947-2 100 kA Icu at 400/415 V AC 50/60 Hz conforming to IEC 60947-2 100 kA Icu at 440 V AC 50/60 Hz conforming to IEC 60947-2 100 kA Icu at 500 V AC 50/60 Hz conforming to IEC 60947-2 100 kA Icu at 690 V AC 50/60 Hz conforming to IEC 60947-2
[Ics] rated service short-circuit breaking capacity	100 % at 230/240 V AC 50/60 Hz conforming to IEC 60947-2 100 % at 400/415 V AC 50/60 Hz conforming to IEC 60947-2 100 % at 440 V AC 50/60 Hz conforming to IEC 60947-2 100 % at 500 V AC 50/60 Hz conforming to IEC 60947-2 100 % at 690 V AC 50/60 Hz conforming to IEC 60947-2
control type	Push-button
[In] rated current	1.6 A
Thermal protection adjustment range	1...1.6 A conforming to IEC 60947-2
Magnetic tripping current	26.2 A
[Ith] conventional free air thermal current	1.6 A conforming to IEC 60947-2
[Ue] rated operational voltage	690 V AC 50/60 Hz conforming to IEC 60947-2
[Ui] rated insulation voltage	690 V AC 50/60 Hz conforming to IEC 60947-2
[Uimp] rated impulse withstand voltage	6 kV conforming to IEC 60947-2

Phase failure sensitivity	Yes conforming to IEC 60947-4-1
Suitability for isolation	Yes conforming to IEC 60947-1
Power dissipation per pole	2.5 W
Mechanical durability	100000 cycles
Electrical durability	100000 cycles for AC-3 at 415 V In 100000 cycles for AC-3e at 415 V In
Rated duty	Uninterrupted conforming to IEC 60947-4-1
Connections - terminals	Power circuit: screw clamp terminal 2 cable(s) 1...6 mm ² solid Power circuit: screw clamp terminal 2 cable(s) 1.5...6 mm ² flexible without cable end Power circuit: screw clamp terminal 2 cable(s) 1...4 mm ² flexible with cable end
Tightening torque	1.7 N.m - on screw clamp terminal
Fixing mode	35 mm symmetrical DIN rail: clipped Panel: screwed (with adaptor plate)
Mounting position	Horizontal Vertical
Width	45 mm
Height	89 mm
Depth	78.5 mm
Net weight	0.26 kg
Colour	Dark grey

Environment

Standards	EN/IEC 60947-2 EN/IEC 60947-4-1 UL 60947-4-1 CSA C22.2 No 60947-4-1 IEC/EN 60335-2-40:Annex JJ IEC/EN 60335-1:Clause 30.2
Product certifications	CCC UL CSA EAC ATEX LROS (Lloyds register of shipping) BV RINA DNV-GL UKCA
IK degree of protection	IK04
IP degree of protection	IP20 conforming to IEC 60529
Climatic withstand	conforming to IACS E10
Ambient air temperature for storage	-40...80 °C
Fire resistance	960 °C conforming to IEC 60695-2-11
Ambient air temperature for operation	-20...60 °C
Mechanical robustness	Shocks: 30 Gn for 11 ms Vibrations: 5 Gn, 5...150 Hz
Operating altitude	<= 2000 m

Packing Units

Unit Type of Package 1	PCE
Number of Units in Package 1	1

Package 1 Height	4.500 cm
Package 1 Width	8.500 cm
Package 1 Length	9.000 cm
Package 1 Weight	253.000 g
Unit Type of Package 2	S02
Number of Units in Package 2	24
Package 2 Height	15.000 cm
Package 2 Width	30.000 cm
Package 2 Length	40.000 cm
Package 2 Weight	6.228 kg
Unit Type of Package 3	P06
Number of Units in Package 3	384
Package 3 Height	75.000 cm
Package 3 Width	60.000 cm
Package 3 Length	80.000 cm
Package 3 Weight	110.504 kg

Logistical informations

Country of origin	FR
-------------------	----

Contractual warranty

Warranty	18 months
----------	-----------



Environmental Data

Schneider Electric aims to achieve Net Zero status by 2050 through supply chain partnerships, lower impact materials, and circularity via our ongoing “Use Better, Use Longer, Use Again” campaign to extend product lifetimes and recyclability.

[Environmental Data explained >](#)

[How we assess product sustainability >](#)

Environmental footprint

Total lifecycle Carbon footprint 43

Environmental Disclosure [Product Environmental Profile](#)

Use Better

Materials and Substances

Packaging made with recycled cardboard Yes

Packaging without single use plastic No

[EU RoHS Directive](#) Compliant with Exemptions

SCIP Number 04104e70-ba29-493c-b2cc-b5837d1f879b

REACH Regulation [REACH Declaration](#)

Use Again

Repack and remanufacture

Recyclability potential, in % 63

End of life manual availability [End of Life Information](#)

Take-back No

WEEE Label  The product must be disposed on European Union markets following specific waste collection and never end up in rubbish bins

Performance Curves

Thermal-Magnetic Tripping Curves for GV2ME and GV2P
 Average Operating Times at 20 °C Related to Multiples of the Setting Current

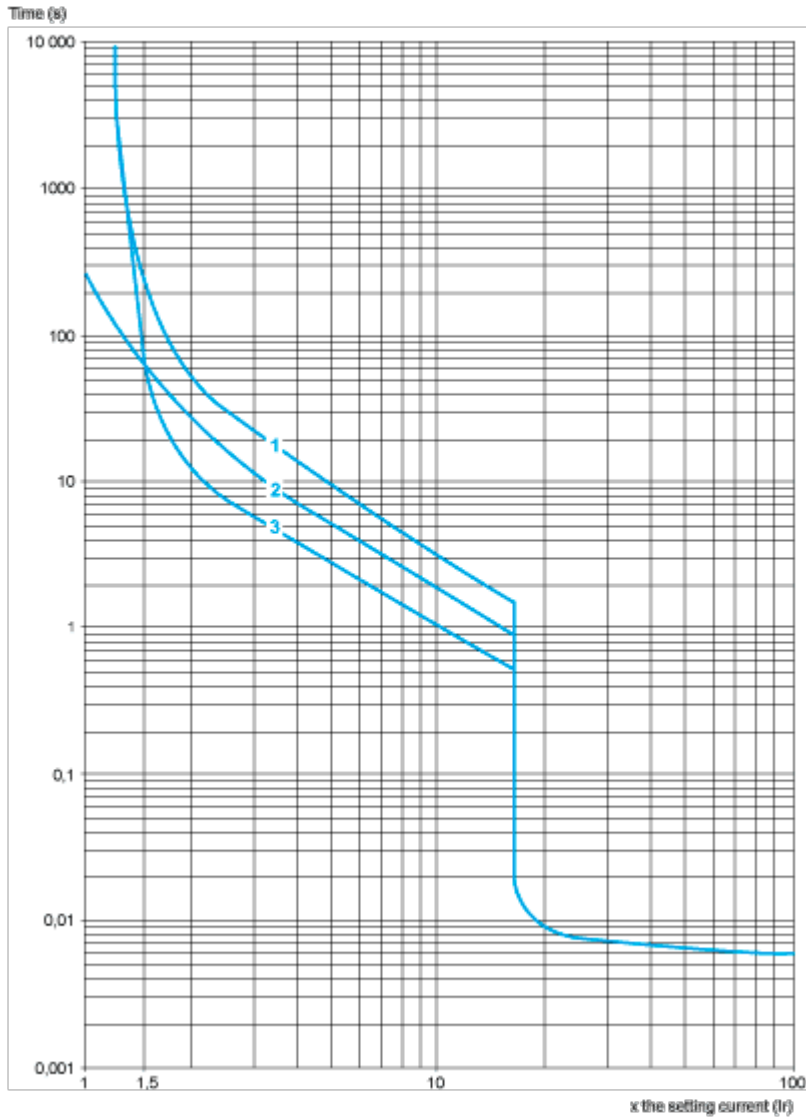

- 1 3 poles from cold state
- 2 2 poles from cold state
- 3 3 poles from hot state

Current Limitation on Short-Circuit for GV2ME and GV2P (3-Phase 400/415 V)

Dynamic Stress

$I_{peak} = f(\text{prospective } I_{sc}) \text{ at } 1.05 U_e = 435 \text{ V}$



- 1 Maximum peak current
- 2 24-32 A
- 3 20-25 A
- 4 17-23 A
- 5 13-18 A
- 6 9-14 A
- 7 6-10 A
- 8 4-6.3 A
- 9 2.5-4 A
- 10 1.6-2.5 A
- 11 1-1.6 A
- 12 Limit of rated ultimate breaking capacity on short-circuit of GV2ME (14, 18, 23, and 25 A ratings).

Thermal Limit on Short-Circuit for GV2ME

Thermal Limit in kA²s in the Magnetic Operating Zone

Sum of I²dt = f (prospective Isc) at 1.05 Ue = 435 V

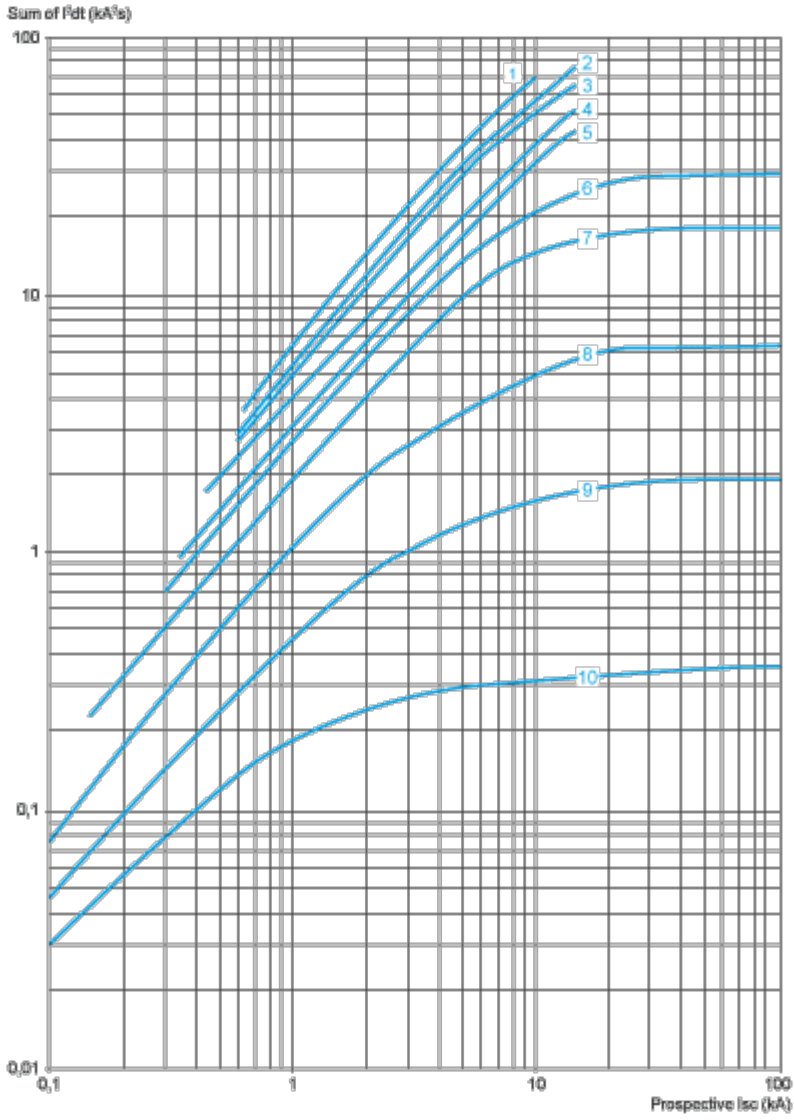

- 1 24-32 A
- 2 20-25 A
- 3 17-23 A
- 4 13-18 A
- 5 9-14 A
- 6 6-10 A
- 7 4-6.3 A
- 8 2.5-4 A
- 9 1.6-2.5 A
- 10 1-1.6 A

Dimensions Drawings

Dimension

GV2ME

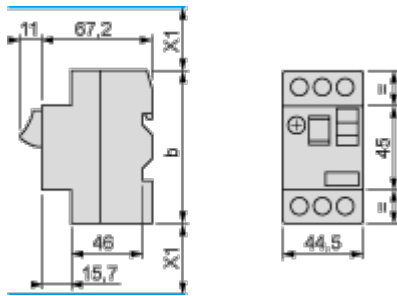

(1) Maximum

X1 Electrical clearance = 40 mm for $U_e \leq 690$ V

	b
GV2ME $\bullet\bullet$	89
GV2ME $\bullet\bullet$ 3	101

Mounting

GV2ME

On 35 mm rail

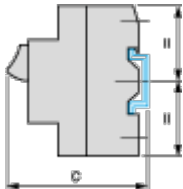

c = 78.5 on AM1 DP200 (35 x 7.5)

c = 86 on AM1 DE200, ED200 (35 x 15)

On panel with adapter plate GV2AF02

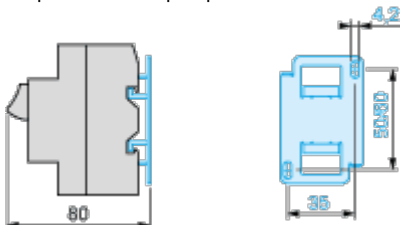

On pre-slotted plate AM1 PA

AF1 EA4

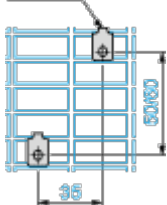

On rails DZ5 MB201

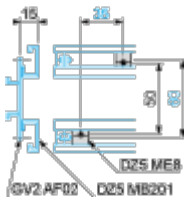

GV2AF01

Combination GV2ME + TeSys k contactor

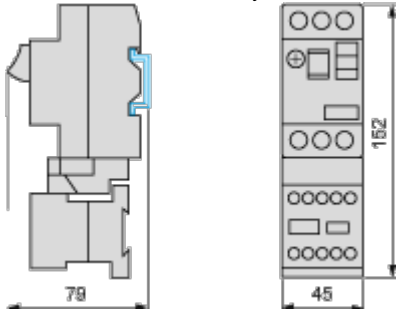

GV2AF3

Combination GV2ME + TeSys d contactor

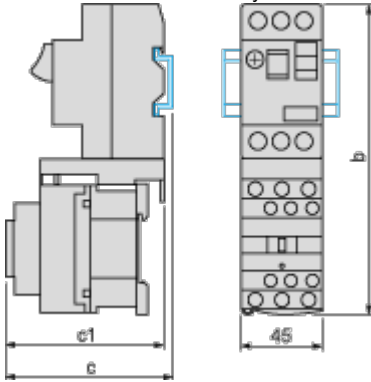

GV2ME +	LC1D09...D18	LC1D25 and D32
b	176.4	186.8
c1	94.1	100.4
c	99.6	105.9

GV2AF4 + LAD311

Combination GV2ME + TeSys d contactor



GV2ME +	LC1D09...D18	LC1D25 and D32
b	176.4	186.8
c1	103.1	136.4
c	135.6	141.9
d1	107	107
d	112.5	112.5

GV2ME + GV1L3 (Current Limiter)



X1 = 10 mm for Ue = 230 V or 30 mm for 230 V < Ue ≤ 690 V

Connections and Schema

GV2ME•• and GV2RT



Connection of Undervoltage Trip for Dangerous Machines (Conforming to INRS) on GV2ME Only

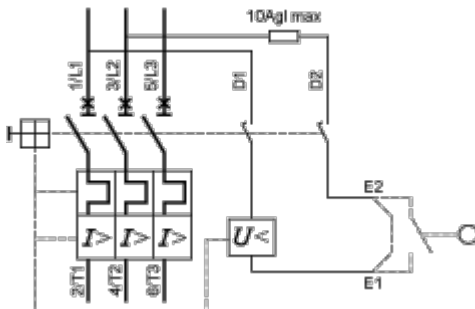

Technical Illustration

Wiring diagram

GV2ME06

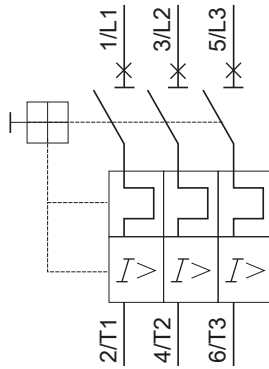

REFER TO TECHNICAL DRAWINGS AND DOCUMENTATION FOR COMPLETE INFORMATION.

Image of product / Alternate images

Alternative

