

# Product datasheet

Specifications



## Motor circuit breaker, TeSys GV2, 3P, 9-14 A, thermal magnetic, screw clamp terminals

Local distributor code:

381807265

GV2ME16

**EAN Code: 3389110343175**

### Main

Range	TeSys Deca
Product name	TeSys GV2
Product or component type	Motor circuit breaker
Device short name	GV2ME
Device application	Motor protection
Trip unit technology	Thermal-magnetic

### Complementary

Poles description	3P
Network type	AC
Utilisation category	Category A conforming to IEC 60947-2 AC-3 conforming to IEC 60947-4-1 AC-3e conforming to IEC 60947-4-1
Network frequency	50/60 Hz conforming to IEC 60947-2
Motor power kW	5.5 kW at 400/415 V AC 50/60 Hz 7.5 kW at 500 V AC 50/60 Hz 9 kW at 690 V AC 50/60 Hz 11 kW at 690 V AC 50/60 Hz
Breaking capacity	100 kA Icu at 230/240 V AC 50/60 Hz conforming to IEC 60947-2 15 kA Icu at 400/415 V AC 50/60 Hz conforming to IEC 60947-2 8 kA Icu at 440 V AC 50/60 Hz conforming to IEC 60947-2 6 kA Icu at 500 V AC 50/60 Hz conforming to IEC 60947-2 3 kA Icu at 690 V AC 50/60 Hz conforming to IEC 60947-2
[Ics] rated service short-circuit breaking capacity	100 % at 230/240 V AC 50/60 Hz conforming to IEC 60947-2 50 % at 400/415 V AC 50/60 Hz conforming to IEC 60947-2 50 % at 440 V AC 50/60 Hz conforming to IEC 60947-2 75 % at 500 V AC 50/60 Hz conforming to IEC 60947-2 75 % at 690 V AC 50/60 Hz conforming to IEC 60947-2
Control type	Push-button
[In] rated current	14 A
Thermal protection adjustment range	9...14 A conforming to IEC 60947-2
Magnetic tripping current	253.4 A
[Ith] conventional free air thermal current	14 A conforming to IEC 60947-2
[Ue] rated operational voltage	690 V AC 50/60 Hz conforming to IEC 60947-2
[Ui] rated insulation voltage	690 V AC 50/60 Hz conforming to IEC 60947-2
[Uimp] rated impulse withstand voltage	6 kV conforming to IEC 60947-2
Phase failure sensitivity	Yes conforming to IEC 60947-4-1

<b>Suitability for isolation</b>	Yes conforming to IEC 60947-1
<b>Power dissipation per pole</b>	2.5 W
<b>Mechanical durability</b>	100000 cycles
<b>Electrical durability</b>	100000 cycles for AC-3 at 415 V In 100000 cycles for AC-3e at 415 V In
<b>Rated duty</b>	Uninterrupted conforming to IEC 60947-4-1
<b>Connections - terminals</b>	Power circuit: screw clamp terminal 2 cable(s) 1...6 mm <sup>2</sup> solid Power circuit: screw clamp terminal 2 cable(s) 1.5...6 mm <sup>2</sup> flexible without cable end Power circuit: screw clamp terminal 2 cable(s) 1...4 mm <sup>2</sup> flexible with cable end
<b>Tightening torque</b>	1.7 N.m - on screw clamp terminal
<b>Fixing mode</b>	35 mm symmetrical DIN rail: clipped Panel: screwed (with adaptor plate)
<b>Mounting position</b>	Horizontal Vertical
<b>Width</b>	45 mm
<b>Height</b>	89 mm
<b>Depth</b>	78.5 mm
<b>Net weight</b>	0.26 kg
<b>Colour</b>	Dark grey

## Environment

<b>Standards</b>	EN/IEC 60947-2 EN/IEC 60947-4-1 UL 60947-4-1 CSA C22.2 No 60947-4-1 IEC/EN 60335-2-40:Annex JJ IEC/EN 60335-1:Clause 30.2
<b>Product certifications</b>	CCC UL CSA EAC ATEX LROS (Lloyds register of shipping) BV RINA DNV-GL UKCA
<b>IK degree of protection</b>	IK04
<b>IP degree of protection</b>	IP20 conforming to IEC 60529
<b>Climatic withstand</b>	conforming to IACS E10
<b>Ambient air temperature for storage</b>	-40...80 °C
<b>Fire resistance</b>	960 °C conforming to IEC 60695-2-11
<b>Ambient air temperature for operation</b>	-20...60 °C
<b>Mechanical robustness</b>	Shocks: 30 Gn for 11 ms Vibrations: 5 Gn, 5...150 Hz
<b>Operating altitude</b>	<= 2000 m

## Packing Units

<b>Unit Type of Package 1</b>	PCE
<b>Number of Units in Package 1</b>	1
<b>Package 1 Height</b>	4.700 cm

Package 1 Width	8.500 cm
Package 1 Length	9.200 cm
Package 1 Weight	280.000 g
Unit Type of Package 2	S02
Number of Units in Package 2	24
Package 2 Height	15.000 cm
Package 2 Width	30.000 cm
Package 2 Length	40.000 cm
Package 2 Weight	6.983 kg
Unit Type of Package 3	P06
Number of Units in Package 3	384
Package 3 Height	75.000 cm
Package 3 Width	60.000 cm
Package 3 Length	80.000 cm
Package 3 Weight	117.000 kg

## Logistical informations

Country of origin	FR
-------------------	----

## Contractual warranty

Warranty	18 months
----------	-----------



## Environmental Data

Schneider Electric aims to achieve Net Zero status by 2050 through supply chain partnerships, lower impact materials, and circularity via our ongoing “Use Better, Use Longer, Use Again” campaign to extend product lifetimes and recyclability.

[Environmental Data explained >](#)

[How we assess product sustainability >](#)

### Environmental footprint

Total lifecycle Carbon footprint 43

Environmental Disclosure [Product Environmental Profile](#)

### Use Better

#### Materials and Substances

Packaging made with recycled cardboard Yes

Packaging without single use plastic No

[EU RoHS Directive](#) Compliant with Exemptions

SCIP Number 04104e70-ba29-493c-b2cc-b5837d1f879b

REACH Regulation [REACH Declaration](#)

### Use Again

#### Repack and remanufacture

Recyclability potential, in % 63

End of life manual availability [End of Life Information](#)

Take-back No

WEEE Label  The product must be disposed on European Union markets following specific waste collection and never end up in rubbish bins

Performance Curves

**Thermal-Magnetic Tripping Curves for GV2ME and GV2P**  
 Average Operating Times at 20 °C Related to Multiples of the Setting Current

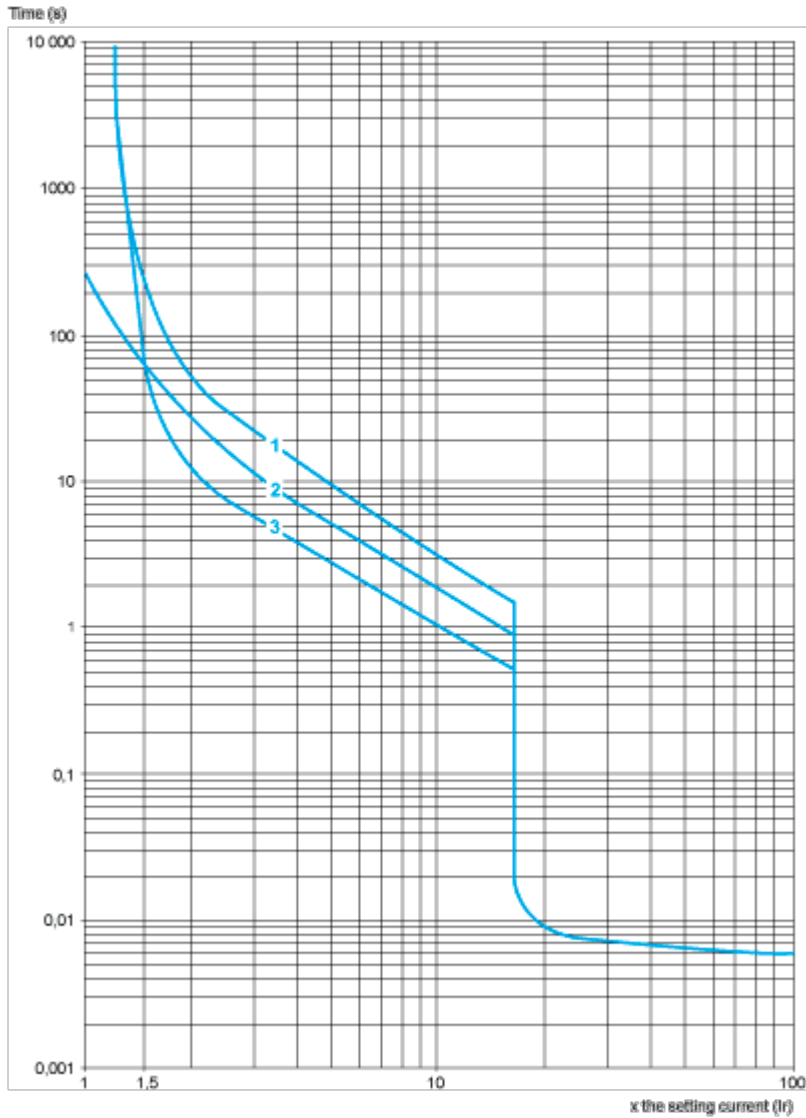

- 1 3 poles from cold state
- 2 2 poles from cold state
- 3 3 poles from hot state

**Current Limitation on Short-Circuit for GV2ME and GV2P (3-Phase 400/415 V)**

**Dynamic Stress**

$I_{peak} = f(\text{prospective } I_{sc}) \text{ at } 1.05 U_e = 435 \text{ V}$

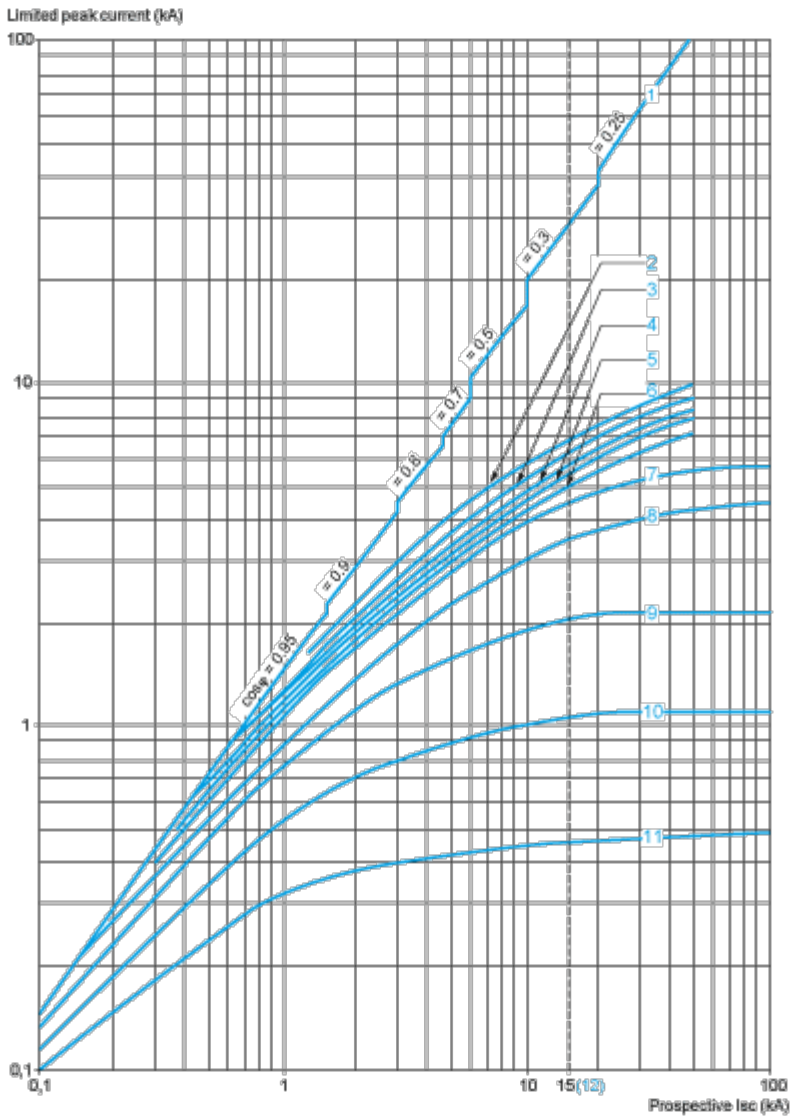

- 1 Maximum peak current
- 2 24-32 A
- 3 20-25 A
- 4 17-23 A
- 5 13-18 A
- 6 9-14 A
- 7 6-10 A
- 8 4-6.3 A
- 9 2.5-4 A
- 10 1.6-2.5 A
- 11 1-1.6 A
- 12 Limit of rated ultimate breaking capacity on short-circuit of GV2ME (14, 18, 23, and 25 A ratings).

**Thermal Limit on Short-Circuit for GV2ME**

Thermal Limit in kA<sup>2</sup>s in the Magnetic Operating Zone

Sum of I<sup>2</sup>dt = f (prospective Isc) at 1.05 Ue = 435 V

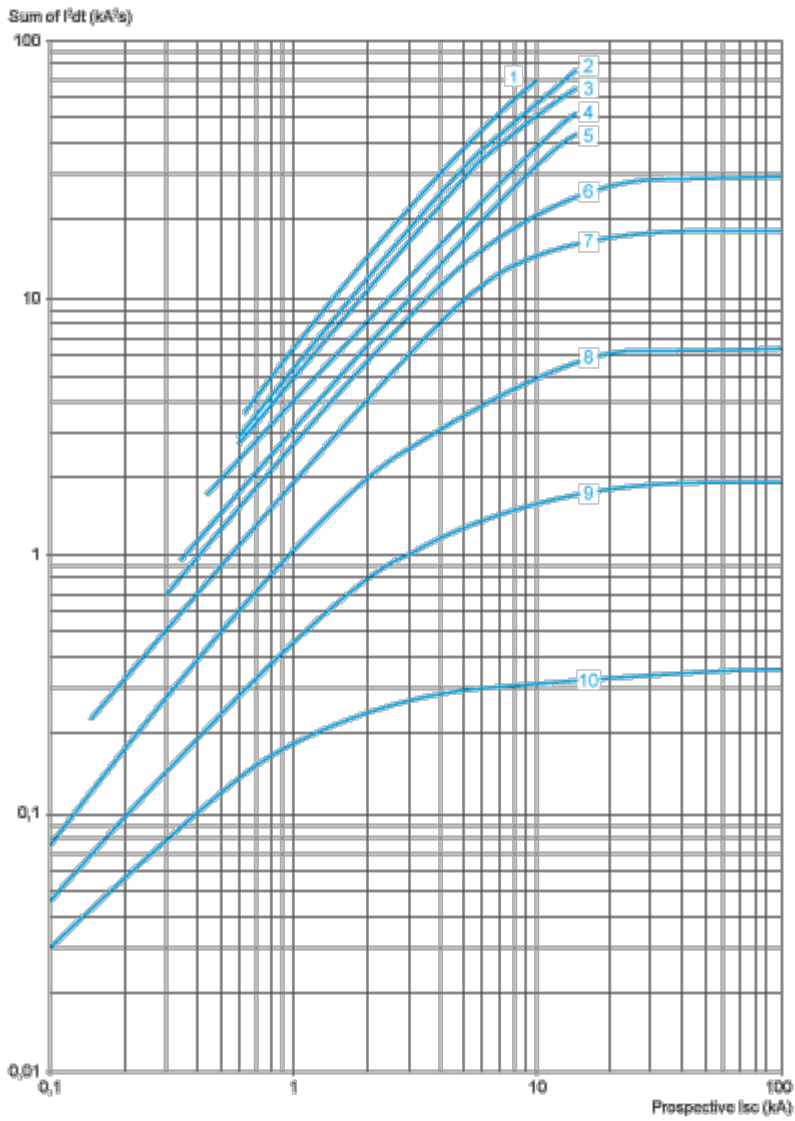

- 1 24-32 A
- 2 20-25 A
- 3 17-23 A
- 4 13-18 A
- 5 9-14 A
- 6 6-10 A
- 7 4-6.3 A
- 8 2.5-4 A
- 9 1.6-2.5 A
- 10 1-1.6 A

Dimensions Drawings

Dimension

GV2ME

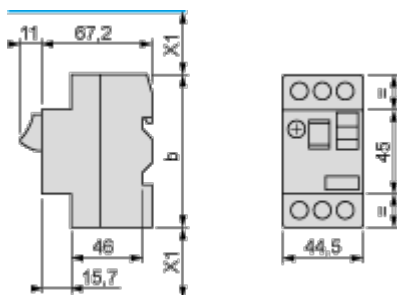

(1) Maximum

X1 Electrical clearance = 40 mm for  $U_e \leq 690$  V

	b
GV2ME $\bullet\bullet$	89
GV2ME $\bullet\bullet$ 3	101

Mounting

GV2ME

On 35 mm rail

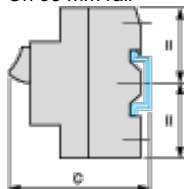

c = 78.5 on AM1 DP200 (35 x 7.5)

c = 86 on AM1 DE200, ED200 (35 x 15)

On panel with adapter plate GV2AF02

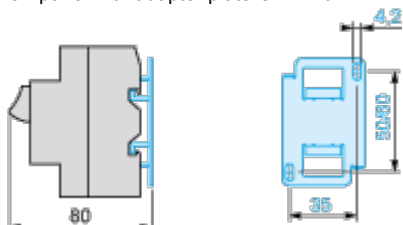

On pre-slotted plate AM1 PA

AF1 EA4

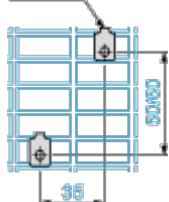

On rails DZ5 MB201

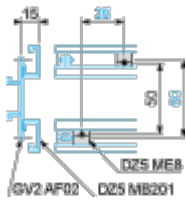

**GV2AF01**

Combination GV2ME + TeSys k contactor

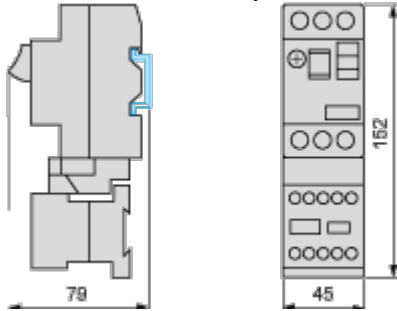

**GV2AF3**

Combination GV2ME + TeSys d contactor

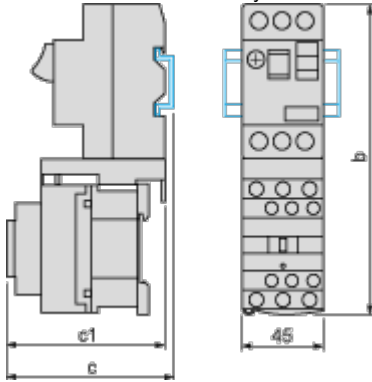

GV2ME +	LC1D09...D18	LC1D25 and D32
b	176.4	186.8
c1	94.1	100.4
c	99.6	105.9

**GV2AF4 + LAD311**

Combination GV2ME + TeSys d contactor



GV2ME +	LC1D09...D18	LC1D25 and D32
b	176.4	186.8
c1	103.1	136.4
c	135.6	141.9
d1	107	107
d	112.5	112.5

GV2ME + GV1L3 (Current Limiter)

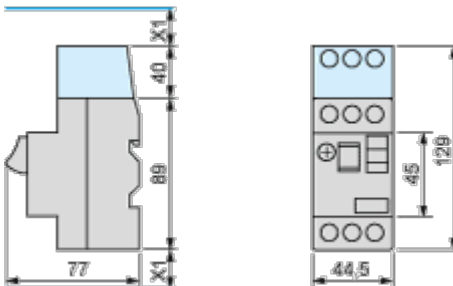

X1 = 10 mm for Ue = 230 V or 30 mm for 230 V < Ue ≤ 690 V

Connections and Schema

---

GV2ME•• and GV2RT



Connection of Undervoltage Trip for Dangerous Machines (Conforming to INRS) on GV2ME Only

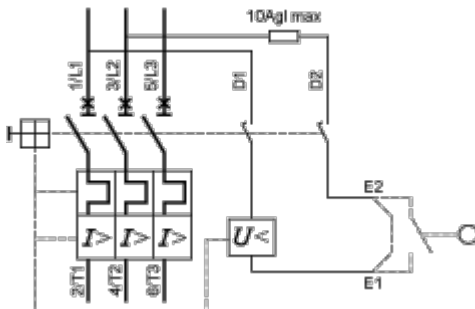

Technical Illustration

Wiring diagram

---

GV2ME $\times$

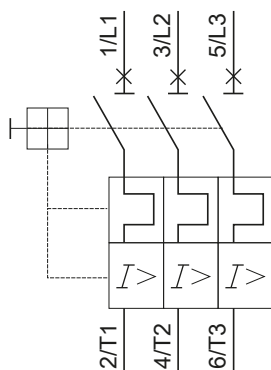

REFER TO TECHNICAL DRAWINGS AND DOCUMENTATION FOR COMPLETE INFORMATION.

Offer Marketing Illustration

Product benefits / Features

---



**TeSys Deca Motor Circuit Breakers**  
Range Accessories

Energy Sensor

Mounting and adapters

Terminal block

Combination block

Motor starter adapter plate

Current limiter

Comb busbar

Auxiliary contact blocks

The image displays a collection of accessories for TeSys Deca Motor Circuit Breakers. At the top left, a main circuit breaker is shown against a green circular background. Below it, eight different accessories are arranged in two rows of four. Each accessory is accompanied by a small image and a text label. The accessories include an energy sensor, various mounting and adapters, terminal blocks, combination blocks, a motor starter adapter plate, a current limiter, a comb busbar, and auxiliary contact blocks.

Offer Marketing Illustration

Product benefits / Features

---



The image shows a TeSys Deca Motor Circuit Breaker, a compact, dark grey device with a red handle. It features three screw terminals at the top (labeled 1, 2, 3) and three at the bottom (labeled 2, 4, 6). A central red handle is labeled 'OFF' and 'ON'. Below the handle, there is a 'TRIP' button and a 'RESET' button. A QR code is visible on the front panel. The device is set against a green circular background.

### TeSys Deca Motor Circuit Breakers

#### Technical Benefits

- High breaking capacity up to 100 kA.
- Screw clamp for the connection, with lug and spring terminals.
- Easily identify the tripped breaker.
- Padlockable in all versions.
- Sealable thermal overload settings without additional accessories.
- Short circuit indication for better diagnostics when a trip occurs.
- Maximum 15 current ratings to cover from 0.1 A to 32 A motor current with a IP20 level for finger safety.

Offer Marketing Illustration

Product benefits / Features

---

## TeSys Deca Motor Circuit Breakers



### Universal Integration

Can be used for all type of applications across industry, infrastructure and buildings.



### Complete protection

Provide short circuit protection, overload protection, motor (ON/OFF) control, all in a single product.



### Standard Sync

Compliant to motor control and protection, in accordance with standards.



Offer Marketing Illustration

Product benefits / Features

---



## TeSys Deca Motor Circuit Breakers Range Accessories



Energy Sensor



Mounting and adapters



Terminal block

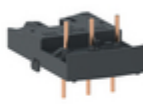

Combination block



Motor starter  
adapter plate



Current limiter



Comb busbar



Auxiliary  
contact blocks

Offer Marketing Illustration

Product benefits / Features

---

## TeSys Deca Motor Circuit Breakers

### Technical Benefits



- High breaking capacity up to 100 kA.
- Screw clamp for the connection, with lug and spring terminals.
- Easily identify the tripped breaker.
- Padlockable in all versions.
- Sealable thermal overload settings without additional accessories.
- Short circuit indication for better diagnostics when a trip occurs.
- Maximum 15 current ratings to cover from 0.1 A to 32 A motor current with a IP20 level for finger safety.

Offer Marketing Illustration

Product benefits / Features

---

## TeSys Deca Motor Circuit Breakers



### Universal Integration

Can be used for all type of applications across industry, infrastructure and buildings.



### Complete protection

Provide short circuit protection, overload protection, motor (ON/OFF) control, all in a single product.



### Standard Sync

Compliant to motor control and protection, in accordance with standards.



Image of product / Alternate images

Alternative

---



