

Product datasheet

Specifications



green flush/red flush illuminated double-headed pushbutton Ø22 with marking

Local distributor code:
393611517

ZB4BW7A3741

EAN Code: 3389119043755

Main

Range of product	Harmony XB4
Product or component type	Head for illuminated double-headed push-button
Product compatibility	Integral LED
Device short name	ZB4
Bezel material	Chromium plated metal
Head type	Standard
Mounting diameter	22 mm
Sale per indivisible quantity	1
Shape of signaling unit head	Rectangular
Type of operator	spring return
Operator profile	2 flush push-buttons - 1 central pilot light
Operators description	Green "I" - red "O"

Complementary

CAD overall width	30 mm
CAD overall height	50 mm
CAD overall depth	30 mm
Net weight	0.056 kg
Resistance to high pressure washer	7000000 Pa at 55 °C, distance : 0.1 m
Colour of marking	Black marking when white caps White marking when green, red or black caps
Operator profile	Green flush, I (white) Red flush, O (white)
Mechanical durability	1000000 cycles
Electrical composition code	M1 for <6 contacts using single blocks in front mounting with integral LED M2 for <6 contacts using single and double blocks in front mounting with integral LED M6 for <2 contacts using single blocks in front mounting with integral LED and transformer M10 for <2 contacts using single blocks in front mounting with integral LED
Device presentation	Basic sub-assemblies

Environment

Protective treatment	TH
Ambient air temperature for storage	-40...70 °C

Ambient air temperature for operation	-40...70 °C
Electrical shock protection class	Class I conforming to IEC 61140
IP degree of protection	IP66 conforming to IEC 60529 IP67 conforming to IEC 60529 IP69 IP69K
NEMA degree of protection	NEMA 13 NEMA 4X
IK degree of protection	IK06 conforming to IEC 50102
Standards	JIS C8201-5-1 UL 508 IEC 60947-5-4 IEC 60947-5-1 CSA C22.2 No 14 IEC 60947-1 IEC 60947-5-5 JIS C8201-1
Product certifications	CSA LROS (Lloyds register of shipping) BV UL listed DNV
Vibration resistance	5 gn (f= 2...500 Hz) conforming to IEC 60068-2-6
Shock resistance	30 gn (duration = 18 ms) for half sine wave acceleration conforming to IEC 60068-2-27 50 gn (duration = 11 ms) for half sine wave acceleration conforming to IEC 60068-2-27

Packing Units

Unit Type of Package 1	PCE
Number of Units in Package 1	1
Package 1 Height	5.500 cm
Package 1 Width	3.300 cm
Package 1 Length	5.300 cm
Package 1 Weight	57.000 g
Unit Type of Package 2	S03
Number of Units in Package 2	200
Package 2 Height	30.000 cm
Package 2 Width	30.000 cm
Package 2 Length	40.000 cm
Package 2 Weight	11.722 kg

Logistical informations

Country of origin	FR
--------------------------	----

Contractual warranty

Warranty	18 months
-----------------	-----------



Environmental Data

Schneider Electric aims to achieve Net Zero status by 2050 through supply chain partnerships, lower impact materials, and circularity via our ongoing “Use Better, Use Longer, Use Again” campaign to extend product lifetimes and recyclability.

[Environmental Data explained >](#)

[How we assess product sustainability >](#)

Environmental footprint

Total lifecycle Carbon footprint 1

Environmental Disclosure [Product Environmental Profile](#)

Use Better

Materials and Substances

Packaging made with recycled cardboard Yes

Packaging without single use plastic Yes

[EU RoHS Directive](#) Pro-active compliance (Product out of EU RoHS legal scope)

REACH Regulation [REACH Declaration](#)

Use Again

Repack and remanufacture

End of life manual availability [End of Life Information](#)

Take-back No

Dimensions Drawings

Dimensions

Without Boot

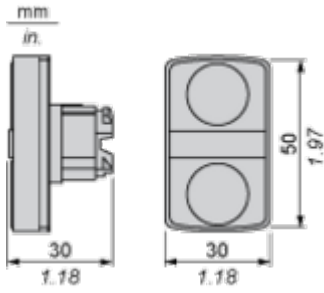

With Boot ZBA708

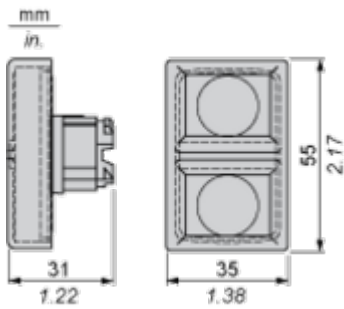

Mounting and Clearance

Panel Cut-out for Pushbuttons, Switches and Pilot Lights (Finished Holes, Ready for Installation)

Connection by Screw Clamp Terminals or Plug-in Connectors or on Printed Circuit Board	Connection by Faston Connectors
	
<p>(1) Diameter on finished panel or support (2) 40 mm min. / 1.57 in. min. (3) 30 mm min. / 1.18 in. min. (4) $\varnothing 22.5 \text{ mm} / 0.89 \text{ in.}$ recommended ($\varnothing 22.3 \text{ mm}_0^{+0.4} / 0.88 \text{ in.}_0^{+0.016}$) (5) 45 mm min. / 1.78 in. min. (6) 32 mm min. / 1.26 in. min.</p>	

Pushbuttons, Switches and Pilot Lights for Printed Circuit Board Connection

Panel Cut-outs (Viewed from Installer's Side)



A: 30 mm min. / 1.18 in. min.
 B: 40 mm min. / 1.57 in. min.

Printed Circuit Board Cut-outs (Viewed from Electrical Block Side)

Dimensions in mm



A: 30 mm min.
 B: 40 mm min.
 Dimensions in in.

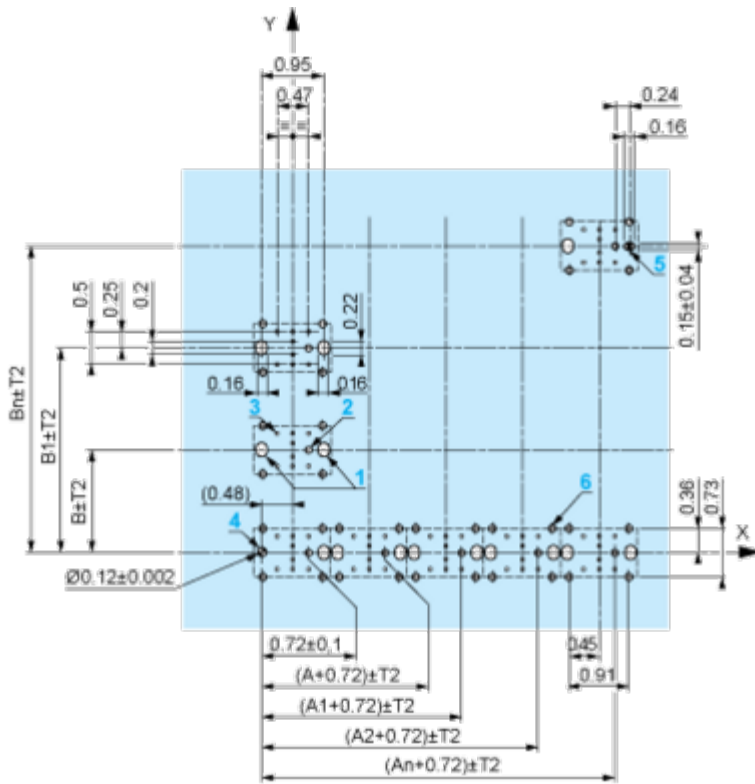

A: 1.18 in. min.
 B: 1.57 in. min.

General Tolerances of the Panel and Printed Circuit Board

The cumulative tolerance must not exceed 0.3 mm / 0.012 in: T1 + T2 = 0.3 mm max.

Installation Precautions

- Minimum thickness of circuit board: 1.6 mm / 0.06 in.
- Cut-out diameter: 22.4 mm ± 0.1 / 0.88 in. ± 0.004
- Orientation of body/fixing collar ZB4 BZ009: ± 2° 30' (excluding cut-outs marked a and b).
- Tightening torque of screws ZBZ 006: 0.6 N.m (5.3 lbf.in) max.
- Allow for one ZB4 BZ079 fixing collar/pillar and its fixing screws:
 - every 90 mm / 3.54 in. horizontally (X), and 120 mm / 4.72 in. vertically (Y).
 - with each selector switch head (ZB4 BD*, ZB4 BJ*, ZB4 BG*).

The fixing centers marked a and b are diagonally opposed and must align with those marked 4 and 5.



(1) Panel

(2) Printed circuit board

Mounting of Adapter (Socket) ZBZ 01•

- 1 2 elongated holes for ZBZ 006 screw access
- 2 1 hole \varnothing 2.4 mm \pm 0.05 / 0.09 in. \pm 0.002 for centring adapter ZBZ 01•
- 3 8 \times \varnothing 1.2 mm / 0.05 in. holes
- 4 1 hole \varnothing 2.9 mm \pm 0.05 / 0.11 in. \pm 0.002, for aligning the printed circuit board (with cut-out marked a)
- 5 1 elongated hole for aligning the printed circuit board (with cut-out marked b)
- 6 4 holes \varnothing 2.4 mm / 0.09 in. for clipping in adapter ZBZ 01•

Dimensions An + 18.1 relate to the \varnothing 2.4 mm \pm 0.05 / 0.09 in. \pm 0.002 holes for centring adapter ZBZ 01•.

Technical Description

Electrical Composition Corresponding to Codes M1 and M7

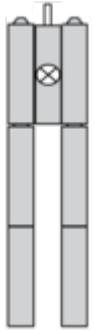

Electrical Composition Corresponding to Codes M2 and M8

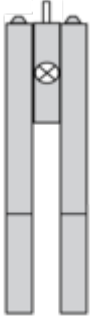

Electrical Composition Corresponding to Codes M6 and P2



Electrical Composition Corresponding to Codes M5, M10, MF1, MR1 and MF2

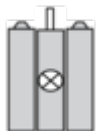

Legend

Single contact



Double contact



Light block



Possible location



Technical Illustration

Dimensions

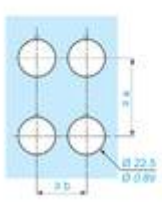
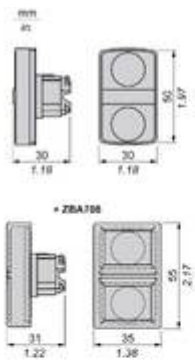

	a (mm)	a (in.)	b (mm)	b (in.)
	40	1.57	30	1.18
ZBE***** ZBV*****				
	45	1.77	32	1.26
ZBE*****3 ZBV*****3				
	40	1.57	30	1.18
ZBE*****4 ZBV*****4				
	50	1.97	30	1.18
ZBE*****5 ZBV*****5				
	40	1.57	30	1.18
ZBE*****9 ZBV*****9				
ZBE1* ZBRV1				





Offer Marketing Illustration

Product benefits / Features

Features

Harmony XB4/XB5 Illuminated functions



-  NEW universal LED Block for all colors
-  Simple stock management
-  Improved installation time and easy selection
-  Improved color intensity and brightness

Offer Marketing Illustration

Product benefits / Features

Technical Benefits

Harmony XB4

Conformity with IEC, UL, CSA, CCC EAC, and JIS standards, as well as CE marking and marine approvals

Up to IP66, 67, 69, 69K, and type 4X protection ratings

High vibration resistance with shake-proof terminal screws

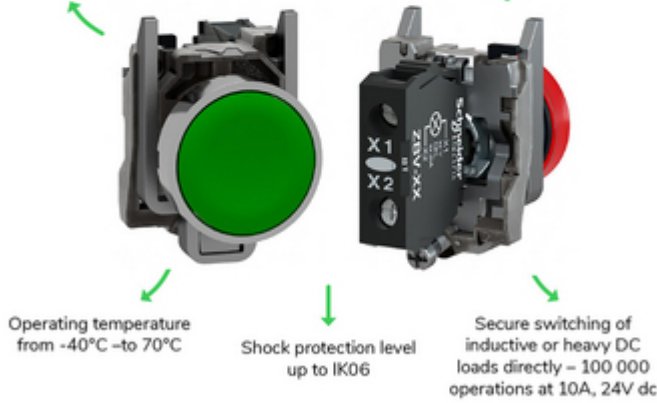

Operating temperature from -40°C to 70°C

Shock protection level up to IK06

Secure switching of inductive or heavy DC loads directly – 100 000 operations at 10A, 24V dc

Offer Marketing Illustration

Product benefits / Features

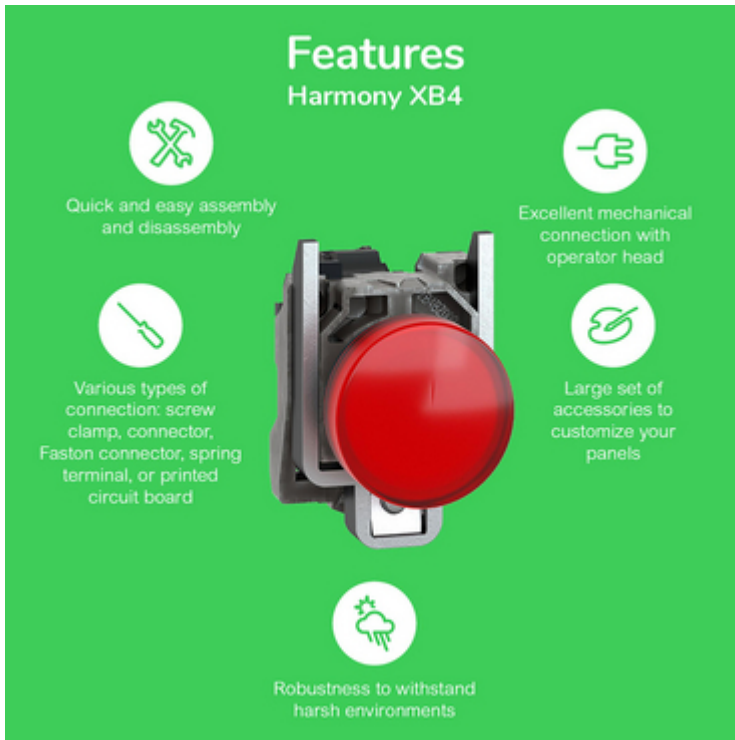

The infographic features a central image of a red Schneider XB4 terminal block. It is surrounded by five circular icons, each with a corresponding text description of a feature. The background is a solid green color.

Features Harmony XB4





-  Quick and easy assembly and disassembly
-  Various types of connection: screw clamp, connector, Faston connector, spring terminal, or printed circuit board
-  Excellent mechanical connection with operator head
-  Large set of accessories to customize your panels
-  Robustness to withstand harsh environments

Image of product / Alternate images

Alternative

