

# Product datasheet

Specifications



Harmony XB5, Selector switch head, plastic, black, Ø22, long handle, 3 positions, stay put, grey bezel

ZB5AJ3C0

EAN Code: 3606489767082

## Main

Range of product	Harmony XB5
Product or component type	Head for selector switch
Device short name	ZB5
Bezel material	Plastic colour plated grey
Mounting diameter	22 mm
Head type	Standard
Sale per indivisible quantity	1
Shape of signaling unit head	Round
Type of operator	stay put
Operator profile	Black long handle
Operator additional information	Non padlockable
Operator position information	3 positions +/- 45°

## Complementary

CAD overall width	29 mm
CAD overall height	38 mm
CAD overall depth	46 mm
Net weight	0.017 kg
Mechanical durability	1000000 cycles
Station name	XALD 1...5 cut-outs XALK 2...5 cut-outs
Electrical composition code	C3 for <6 contacts using single blocks in front mounting C4 for <6 contacts using single and double blocks in front mounting C5 for <5 contacts using single blocks in front mounting C6 for <5 contacts using single and double blocks in front mounting C7 for <4 contacts using single blocks in front mounting C8 for <4 contacts using single and double blocks in front mounting C11 for <3 contacts using single blocks in front mounting SF1 for <3 contacts using single blocks in front mounting SR1 for <3 contacts using single blocks in rear mounting
Device presentation	Basic element

## Environment

Protective treatment	TH
Ambient air temperature for storage	-40...70 °C

<b>Ambient air temperature for operation</b>	-40...70 °C
<b>Overvoltage category</b>	Class II conforming to IEC 60536
<b>IP degree of protection</b>	IP67 conforming to IEC 60529
<b>NEMA degree of protection</b>	NEMA 13 NEMA 4X
<b>Resistance to high pressure washer</b>	7000000 Pa at 55 °C, distance : 0.1 m
<b>IK degree of protection</b>	IK06 conforming to IEC 50102
<b>Standards</b>	UL 508 IEC 60947-5-4 IEC 60947-1 CSA C22.2 No 14 IEC 60947-5-1 JIS C8201-5-1 JIS C8201-1
<b>Product certifications</b>	CSA DNV BV LROS (Lloyds register of shipping) UL listed
<b>Vibration resistance</b>	5 gn (f= 2...500 Hz) conforming to IEC 60068-2-6
<b>Shock resistance</b>	30 gn (duration = 18 ms) for half sine wave acceleration conforming to IEC 60068-2-27 50 gn (duration = 11 ms) for half sine wave acceleration conforming to IEC 60068-2-27

## Packing Units

<b>Unit Type of Package 1</b>	PCE
<b>Number of Units in Package 1</b>	1
<b>Package 1 Height</b>	3.400 cm
<b>Package 1 Width</b>	4.600 cm
<b>Package 1 Length</b>	5.200 cm
<b>Package 1 Weight</b>	22.000 g

## Contractual warranty

<b>Warranty</b>	18 months
-----------------	-----------

## Environmental Data

Schneider Electric aims to achieve Net Zero status by 2050 through supply chain partnerships, lower impact materials, and circularity via our ongoing “Use Better, Use Longer, Use Again” campaign to extend product lifetimes and recyclability.

[Environmental Data explained >](#)

[How we assess product sustainability >](#)

### Environmental footprint

[Environmental Disclosure](#)

[Product Environmental Profile](#)

## Use Better

### Materials and Substances

Packaging made with recycled cardboard

Yes

Packaging without single use plastic

Yes

[EU RoHS Directive](#)

Pro-active compliance (Product out of EU RoHS legal scope)

REACH Regulation

[REACH Declaration](#)

## Use Again

### Repack and remanufacture

End of life manual availability

[End of Life Information](#)

Take-back

No

Dimensions Drawings

Dimensions

---

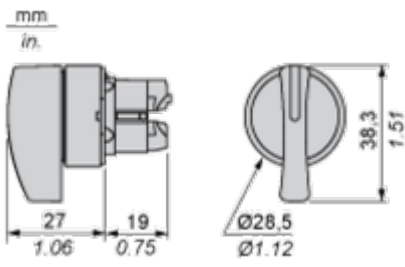

Mounting and Clearance

**Panel Cut-out for Pushbuttons, Switches and Pilot Lights (Finished Holes, Ready for Installation)**

**Connection by Screw Clamp Terminals or Plug-in Connectors or on Printed Circuit Board**



- (1) Diameter on finished panel or support
- (2) For selector switches and Emergency stop buttons, use of an anti-rotation plate type ZB5AZ902 is recommended.
- (3)  $\varnothing 22.5$  mm recommended ( $\varnothing 22.3_0^{+0.4}$ ) /  $\varnothing 0.89$  in. recommended ( $\varnothing 0.88_0^{+0.016}$ )

Connections	a in mm	a in in.	b in mm	b in in.
By screw clamp terminals or plug-in connector	40	1.57	30	1.18
By Faston connectors	45	1.77	32	1.26
On printed circuit board	30	1.18	30	1.18

**Detail of Lug Recess**



- (1) Diameter on finished panel or support
- (2) For selector switches and Emergency stop buttons, use of an anti-rotation plate type ZB5AZ902 is recommended.
- (3)  $\varnothing 22.5$  mm recommended ( $\varnothing 22.3_0^{+0.4}$ ) /  $\varnothing 0.89$  in. recommended ( $\varnothing 0.88_0^{+0.016}$ )

Pushbuttons, Switches and Pilot Lights for Printed Circuit Board Connection

Panel Cut-outs (Viewed from Installer's Side)

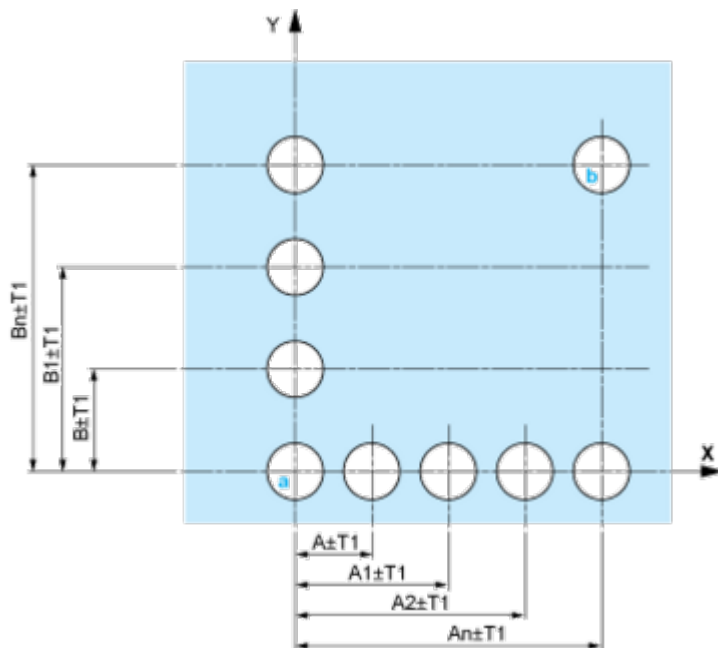

A: 30 mm min. / 1.18 in. min.

B: 40 mm min. / 1.57 in. min.

Printed Circuit Board Cut-outs (Viewed from Electrical Block Side)

Dimensions in mm

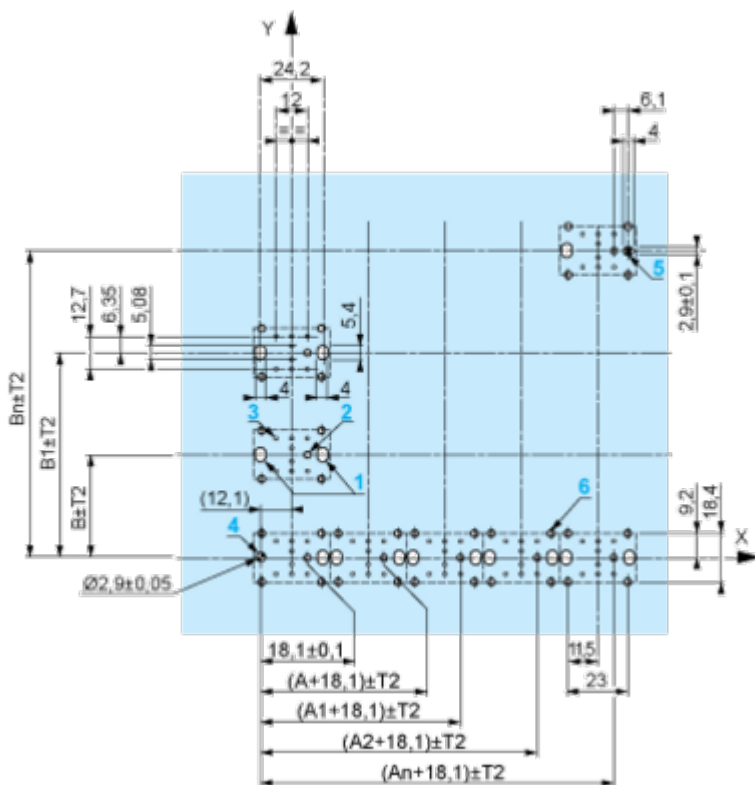

A: 30 mm min.

B: 40 mm min.

Dimensions in in.



A: 1.18 in. min.  
 B: 1.57 in. min.

**General Tolerances of the Panel and Printed Circuit Board**

The cumulative tolerance must not exceed 0.3 mm / 0.012 in.: T1 + T2 = 0.3 mm max.

**Installation Precautions**

- Minimum thickness of circuit board: 1.6 mm / 0.06 in.
- Cut-out diameter: 22.4 mm ± 0.1 / 0.88 in. ± 0.004
- Orientation of body/fixing collar ZB5AZ009: ± 2° 30' (excluding cut-outs marked a and b).
- Tightening torque of screws ZBZ006: 0.6 N.m (5.3 lbf.in) max.
- Allow for one ZB5AZ079 fixing collar/pillar and its fixing screws:
  - every 90 mm / 3.54 in. horizontally (X), and 120 mm / 4.72 in. vertically (Y).
  - with each selector switch head (ZB5AD\*, ZB5AJ\*, ZB5AG\*).

The fixing centers marked a and b are diagonally opposed and must align with those marked 4 and 5.



- (1) Head ZB5AD•
- (2) Panel
- (2) Nut
- (4) Printed circuit board

## Mounting of Adapter (Socket) ZBZ01•

- 1 2 elongated holes for ZBZ006 screw access
- 2 1 hole  $\varnothing$  2.4 mm  $\pm$  0.05 / 0.09 in.  $\pm$  0.002 for centring adapter ZBZ01•
- 3 8  $\times$   $\varnothing$  1.2 mm / 0.05 in. holes
- 4 1 hole  $\varnothing$  2.9 mm  $\pm$  0.05 / 0.11 in.  $\pm$  0.002, for aligning the printed circuit board (with cut-out marked **a**)
- 5 1 elongated hole for aligning the printed circuit board (with cut-out marked **b**)
- 6 4 holes  $\varnothing$  2.4 mm / 0.09 in. for clipping in adapter ZBZ01•

Dimensions An + 18.1 relate to the  $\varnothing$  2.4 mm  $\pm$  0.05 / 0.09 in.  $\pm$  0.002 holes for centring adapter ZBZ01•.

Technical Description

Electrical Composition Corresponding to Code C3

---



Electrical Composition Corresponding to Code C4

---



Electrical Composition Corresponding to Code C5

---



Electrical Composition Corresponding to Code C6

---



Electrical Composition Corresponding to Code C7

---



Electrical Composition Corresponding to Code C8

---

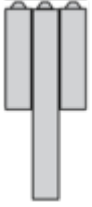

Electrical Composition Corresponding to Codes C9, C11, SF1 and SR1

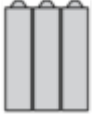

Electrical Composition Corresponding to Code C15

---

1 N/O



1 N/C



1 N/O + N/C or 1 N/O + N/O or 1 N/C + N/C



**Legend**

---

Single contact



Double contact



Light block



Possible location



Sequence of Contacts Fitted to 3-position Selector Switch Body

Position 315°



Push	Position	Top			
		Bottom			
	Location		Left	Centre	Right
	State		1	1	0
Contacts	N/O		closed	closed	open
	N/C		open	open	closed

Position 0°



Push	Position	Top			
		Bottom			
	Location		Left	Centre	Right
	State		0	0	0
Contacts	N/O		open	open	open
	N/C		closed	closed	closed

Position 45°



<b>Push</b>	Position	Top			
		Bottom			
	Location		Left	Centre	Right
	State		0	1	1
<b>Contacts</b>	N/O		open	closed	closed
	N/C		closed	open	open

Technical Illustration

Dimensions

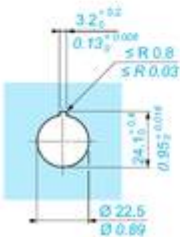
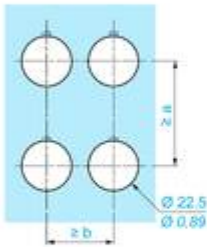
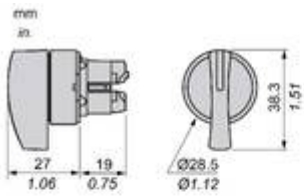

		a (mm)	a (in.)	b (mm)	b (in.)
		40	1.57	30	1.18
ZBE.....	ZBV.....				
		45	1.77	32	1.26
ZBE.....3	ZBV.....3				
		40	1.57	30	1.18
ZBE.....4	ZBV.....4				
		50	1.97	30	1.18
ZBE.....5	ZBV.....5				
		40	1.57	30	1.18
ZBE.....9	ZBV.....9				
		40	1.57	30	1.18
ZBRT...	ZBRV1				

Offer Marketing Illustration

Product benefits / Features

---

### Features Harmony XB5



- 

Quick and easy assembly and disassembly
- 

Excellent mechanical connection with operator head
- 

Various types of connection: screw clamp, connector, Faston connector, spring terminal, or printed circuit board
- 

Large set of accessories to customize your panels
- 

Robustness to withstand harsh environments

Offer Marketing Illustration

Product benefits / Features

---

## Technical Benefits

Harmony XB5



Image of product / Alternate images

Alternative

---





