

# Product datasheet

Specifications



## Emergency stop head, switching off, plastic, red mushroom Ø40, Ø22, trigger and latching turn to release

Local distributor code:

237183101

ZB5AS844

**EAN Code: 3389110906929**

### Main

Range of product	Harmony XB5
Product or component type	Head for emergency stop push-button
Product destination	Emergency stop push-button
Device short name	ZB5
Bezel material	Dark grey plastic
Head type	Standard
Mounting diameter	22 mm
Sale per indivisible quantity	1
Shape of signaling unit head	Round
Type of operator	trigger action and mechanical latching
Reset	Turn to release
Operator profile	Red mushroom Ø 40 mm, unmarked
Device presentation	Basic element

### Complementary

CAD overall width	40 mm
CAD overall height	40 mm
CAD overall depth	57 mm
Net weight	0.046 kg
Mechanical durability	300000 cycles
Station name	XALD 1 cut-out XALK 1 cut-out
Electrical composition code	C7 for <4 contacts using single blocks in front mounting C8 for <4 contacts using single and double blocks in front mounting C11 for <3 contacts using single blocks in front mounting C15 for <1 contacts using single blocks in front mounting SF1 for <3 contacts using single blocks in front mounting SR1 for <3 contacts using single blocks in rear mounting C10 for <4 contacts using single and double blocks in front mounting
Compatibility code	ZB5

### Environment

Protective treatment	TH
Ambient air temperature for storage	-40...70 °C
Ambient air temperature for operation	-40...70 °C

<b>Overvoltage category</b>	Class II conforming to IEC 60536
<b>IP degree of protection</b>	IP66 conforming to IEC 60529 IP67 IP69 IP69K
<b>NEMA degree of protection</b>	NEMA 13 NEMA 4X
<b>Resistance to high pressure washer</b>	7000000 Pa at 55 °C, distance : 0.1 m
<b>IK degree of protection</b>	IK03 conforming to IEC 50102
<b>Standards</b>	UL 508 ISO 13850 IEC 60364-5-53 IEC 60204-1 GB 14048.5 JIS C8201-5-1 IEC 60947-5-4 CSA C22.2 No 14 IEC 60947-5-5 IEC 60947-1 IEC 60947-5-1 JIS C8201-1
<b>Product certifications</b>	CSA DNV BV LROS (Lloyds register of shipping) UL listed
<b>Vibration resistance</b>	5 gn (f= 2...500 Hz) conforming to IEC 60068-2-6
<b>Shock resistance</b>	30 gn (duration = 18 ms) for half sine wave acceleration conforming to IEC 60068-2-27 50 gn (duration = 11 ms) for half sine wave acceleration conforming to IEC 60068-2-27

## Packing Units

<b>Unit Type of Package 1</b>	PCE
<b>Number of Units in Package 1</b>	1
<b>Package 1 Height</b>	5.400 cm
<b>Package 1 Width</b>	4.400 cm
<b>Package 1 Length</b>	8.800 cm
<b>Package 1 Weight</b>	41.000 g
<b>Unit Type of Package 2</b>	S03
<b>Number of Units in Package 2</b>	100
<b>Package 2 Height</b>	30.000 cm
<b>Package 2 Width</b>	30.000 cm
<b>Package 2 Length</b>	40.000 cm
<b>Package 2 Weight</b>	4.544 kg
<b>Unit Type of Package 3</b>	P06
<b>Number of Units in Package 3</b>	800
<b>Package 3 Height</b>	75.000 cm
<b>Package 3 Width</b>	60.000 cm
<b>Package 3 Length</b>	80.000 cm
<b>Package 3 Weight</b>	47.804 kg

## Logistical informations

---

Country of origin CZ

## Contractual warranty

---

Warranty 18 months

## Environmental Data

Schneider Electric aims to achieve Net Zero status by 2050 through supply chain partnerships, lower impact materials, and circularity via our ongoing “Use Better, Use Longer, Use Again” campaign to extend product lifetimes and recyclability.

[Environmental Data explained >](#)

[How we assess product sustainability >](#)

### Environmental footprint

Total lifecycle Carbon footprint 1

Environmental Disclosure [Product Environmental Profile](#)

### Use Better

#### Materials and Substances

Packaging made with recycled cardboard No

Packaging without single use plastic No

[EU RoHS Directive](#) Pro-active compliance (Product out of EU RoHS legal scope)

REACH Regulation [REACH Declaration](#)

### Use Again

#### Repack and remanufacture

Recyclability potential, in % 21

End of life manual availability [End of Life Information](#)

Take-back No

Dimensions Drawings

Dimensions

---

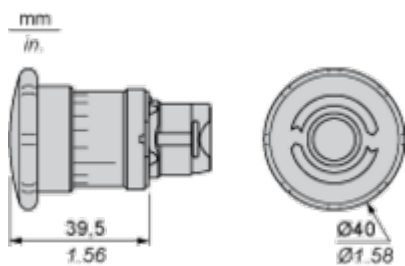

Mounting and Clearance

**Panel Cut-out for Pushbuttons, Switches and Pilot Lights (Finished Holes, Ready for Installation)**

**Connection by Screw Clamp Terminals or Plug-in Connectors or on Printed Circuit Board**



- (1) Diameter on finished panel or support
- (2) For selector switches and Emergency stop buttons, use of an anti-rotation plate type ZB5AZ902 is recommended.
- (3) Ø22.5 mm recommended ( $\text{Ø}22.3_0^{+0.4}$ ) / Ø0.89 in. recommended ( $\text{Ø}0.88_0^{+0.016}$ )

Connections	a in mm	a in in.	b in mm	b in in.
By screw clamp terminals or plug-in connector	40	1.57	30	1.18
By Faston connectors	45	1.77	32	1.26
On printed circuit board	30	1.18	30	1.18

**Detail of Lug Recess**



- (1) Diameter on finished panel or support
- (2) For selector switches and Emergency stop buttons, use of an anti-rotation plate type ZB5AZ902 is recommended.
- (3) Ø22.5 mm recommended ( $\text{Ø}22.3_0^{+0.4}$ ) / Ø0.89 in. recommended ( $\text{Ø}0.88_0^{+0.016}$ )





A: 1.18 in. min.  
 B: 1.57 in. min.

**General Tolerances of the Panel and Printed Circuit Board**

The cumulative tolerance must not exceed 0.3 mm / 0.012 in.: T1 + T2 = 0.3 mm max.

**Installation Precautions**

- Minimum thickness of circuit board: 1.6 mm / 0.06 in.
- Cut-out diameter: 22.4 mm ± 0.1 / 0.88 in. ± 0.004
- Orientation of body/fixing collar ZB5AZ009: ± 2° 30' (excluding cut-outs marked a and b).
- Tightening torque of screws ZBZ006: 0.6 N.m (5.3 lbf.in) max.
- Allow for one ZB5AZ079 fixing collar/pillar and its fixing screws:
  - every 90 mm / 3.54 in. horizontally (X), and 120 mm / 4.72 in. vertically (Y).
  - with each selector switch head (ZB5AD\*, ZB5AJ\*, ZB5AG\*).

The fixing centers marked a and b are diagonally opposed and must align with those marked 4 and 5.

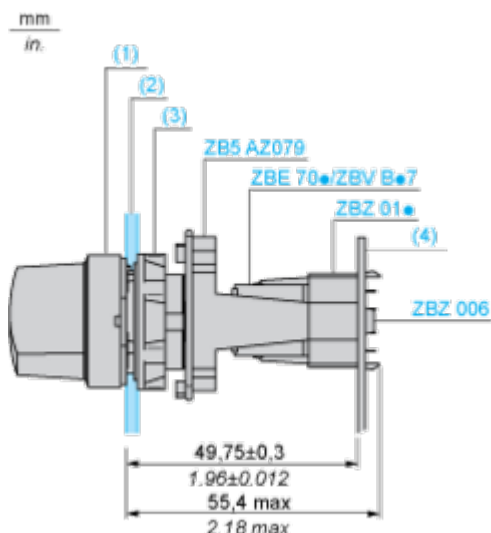

- (1) Head ZB5AD•
- (2) Panel
- (2) Nut
- (4) Printed circuit board

## Mounting of Adapter (Socket) ZBZ01•

- 1 2 elongated holes for ZBZ006 screw access
- 2 1 hole  $\varnothing$  2.4 mm  $\pm$  0.05 / 0.09 in.  $\pm$  0.002 for centring adapter ZBZ01•
- 3 8  $\times$   $\varnothing$  1.2 mm / 0.05 in. holes
- 4 1 hole  $\varnothing$  2.9 mm  $\pm$  0.05 / 0.11 in.  $\pm$  0.002, for aligning the printed circuit board (with cut-out marked **a**)
- 5 1 elongated hole for aligning the printed circuit board (with cut-out marked **b**)
- 6 4 holes  $\varnothing$  2.4 mm / 0.09 in. for clipping in adapter ZBZ01•

Dimensions An + 18.1 relate to the  $\varnothing$  2.4 mm  $\pm$  0.05 / 0.09 in.  $\pm$  0.002 holes for centring adapter ZBZ01•.

Technical Description

Electrical Composition Corresponding to Code C7

---



Electrical Compositions Corresponding to Code C8

---

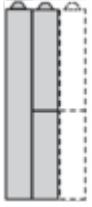

Electrical Compositions Corresponding to Code C10

---

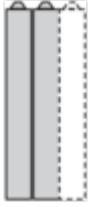

Electrical Composition Corresponding to Codes C9, C11, SF1 and SR1

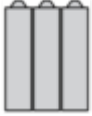

Electrical Composition Corresponding to Code C15

---

1 N/O

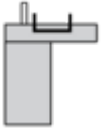

1 N/C



1 N/O + N/C or 1 N/O + N/O or 1 N/C + N/C



**Legend**

---

Single contact



Double contact



Light block



Possible location



Technical Illustration

Dimensions

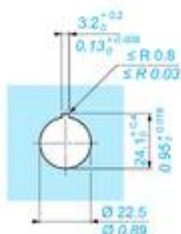
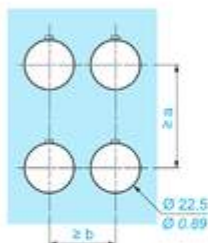
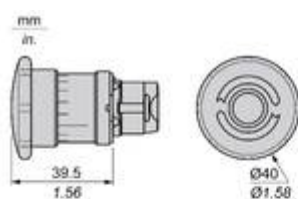

		a (mm)	a (in.)	b (mm)	b (in.)
		40	1.57	30	1.18
ZBE.....	ZBV.....				
		45	1.77	32	1.26
ZBE.....3	ZBV.....3				
		40	1.57	30	1.18
ZBE.....4	ZBV.....4				
		50	1.97	30	1.18
ZBE.....5	ZBV.....5				
		40	1.57	30	1.18
ZBE.....9	ZBV.....9				
		40	1.57	30	1.18
ZBRT..	ZBRV1				

Offer Marketing Illustration

Product benefits / Features

---

### Features

#### Harmony XB5 e-stop function



 Wide modular range to suit machines and operator safety.

 Ergonomic design for emergency actuation in several environments

 Designed to fit in a standard 22mm cut-out or Harmony XALK control station ensuring compatibility with pre-existing machinery

 Illuminated types to improve operator efficiency by reducing production downtime.

 Large set of accessories: circular legends, illuminated legend rings, protective bellows for harsh environments and protective guards.

Offer Marketing Illustration

Product benefits / Features

---



The infographic features a central image of a grey and green terminal block. Surrounding it are five circular icons, each with a corresponding text description. The background is a solid green color.

### Features Harmony XB5

-  Quick and easy assembly and disassembly
-  Excellent mechanical connection with operator head
-  Various types of connection: screw clamp, connector, Faston connector, spring terminal, or printed circuit board
-  Large set of accessories to customize your panels
-  Robustness to withstand harsh environments

Offer Marketing Illustration

Product benefits / Features

---

## Technical Benefits

Harmony XB5



Offer Marketing Illustration

Product benefits / Features

---

## Technical Benefits

### Harmony XB5 e-stop function

Fit to several customer functions needs: turn to release, push to release, key release

Guarantee of proper installation thanks to NC contact with monitoring function.



Designed as per international standards for high performance.

Fit for all machine sizes and environments:

- Small machines > 30 mm
- Standard machines > 40 mm
- Use of gloves > 60 mm

Image of product / Alternate images

Alternative

---







Image of product in real life situation

