

Product datasheet

Specifications

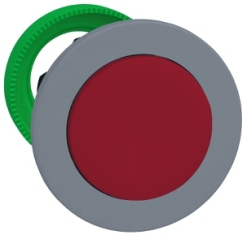

Harmony XB5, Flush mounted push button head, plastic, projecting red, Ø30, push-push, grey bezel

ZB5FH4C0

EAN Code: 3606489773243

Main

Range of product	Harmony XB5
Product or component type	Head for non-illuminated push-button
Device short name	ZB5F
Product compatibility	ZBYF... ZBZF32 ZBZF33 ZB5AZ
Bezel material	Plastic colour plated grey
Mounting diameter	30.5 mm
Head type	Built-in-flush
Sale per indivisible quantity	1
Shape of signaling unit head	Round
Type of operator	push-push
Operator profile	Red projecting, unmarked

Complementary

CAD overall width	37 mm
CAD overall height	37 mm
CAD overall depth	32 mm
Net weight	0.031 kg
Mechanical durability	500000 cycles
Electrical composition code	C11 for <3 contacts using single blocks in front mounting C15 for <1 contacts using single blocks in front mounting SF1 for <3 contacts using single blocks in front mounting C9 for <3 contacts using single blocks in front mounting
Device presentation	Basic element

Environment

Protective treatment	TH
Ambient air temperature for storage	-40...70 °C
Ambient air temperature for operation	-40...70 °C
Overvoltage category	Class II conforming to IEC 60536
IP degree of protection	IP66 conforming to IEC 60529 IP67 conforming to IEC 60529
Resistance to high pressure washer	7000000 Pa at 55 °C, distance : 0.1 m

IK degree of protection	IK03 conforming to IEC 50102
Standards	UL 508 IEC 60947-5-4 IEC 60947-1 JIS C8201-5-1 IEC 60947-5-1 CSA C22.2 No 14 JIS C8201-1
Product certifications	UL listed CSA
Shock resistance	30 gn (duration = 18 ms) for half sine wave acceleration conforming to IEC 60068-2-27 50 gn (duration = 11 ms) for half sine wave acceleration conforming to IEC 60068-2-27 25 gn (duration = 6 ms) for 1000 shocks on each axis conforming to IEC 60068-2-27
Vibration resistance	5 gn (f= 10...500 Hz) conforming to IEC 60068-2-6 2 mm peak to peak (f= 2...10 Hz) conforming to IEC 60068-2-6

Packing Units

Unit Type of Package 1	PCE
Number of Units in Package 1	1
Package 1 Height	5.45 cm
Package 1 Width	4.3 cm
Package 1 Length	5.2 cm
Package 1 Weight	25.0 g

Contractual warranty

Warranty	18 months
-----------------	-----------

Environmental Data

Schneider Electric aims to achieve Net Zero status by 2050 through supply chain partnerships, lower impact materials, and circularity via our ongoing “Use Better, Use Longer, Use Again” campaign to extend product lifetimes and recyclability.

[Environmental Data explained >](#)

[How we assess product sustainability >](#)

Environmental footprint

[Environmental Disclosure](#)

[Product Environmental Profile](#)

Use Better

Materials and Substances

Packaging made with recycled cardboard

No

Packaging without single use plastic

No

[EU RoHS Directive](#)

Pro-active compliance (Product out of EU RoHS legal scope)

REACH Regulation

[REACH Declaration](#)

Use Again

Repack and remanufacture

End of life manual availability

[End of Life Information](#)

Take-back

No

Dimensions Drawings

Dimensions

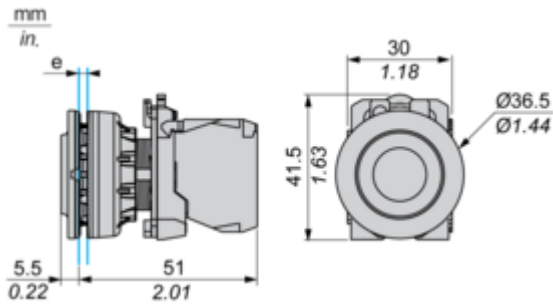

e: Clamping thickness: 1 to 6 mm / 0.04 to 0.24 in.

Mounting and Clearance

Panel Cut-out for Pushbuttons, Switches and Pilot Lights (Finished Holes, Ready for Installation)

Connection by Screw Clamp Terminals or Plug-in Connectors

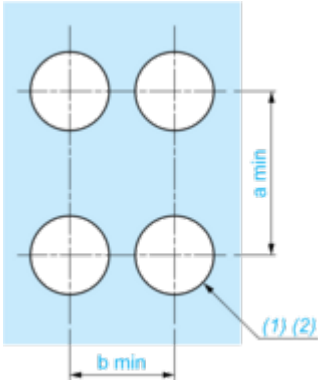

(1) Diameter on finished panel or support

(2) $\varnothing 30.75$ mm recommended ($\varnothing 30.5 \begin{smallmatrix} +0.5 \\ 0 \end{smallmatrix}$) / $\varnothing 1.21$ in. recommended ($\varnothing 1.20$ in. $\begin{smallmatrix} +0.0196 \\ 0 \end{smallmatrix}$)

Connections	a in mm	a in in.	b in mm	b in in.
By screw clamp terminals or plug-in connector	40	1.57	40	1.57
By Faston connectors	45	1.77	40	1.57

Technical Description

Electrical Composition Corresponding to Code C1

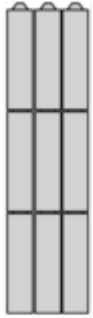

Electrical Composition Corresponding to Code C2



Electrical Composition Corresponding to Codes C9, C11, SF1 and SR1

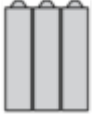

Electrical Composition Corresponding to Code C15

1 N/O

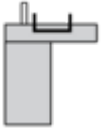

1 N/C



1 N/O + N/C or 1 N/O + N/O or 1 N/C + N/C



Legend

Single contact



Double contact



Light block



Possible location



Technical Illustration

Dimensions

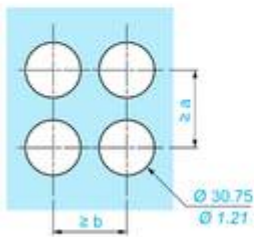
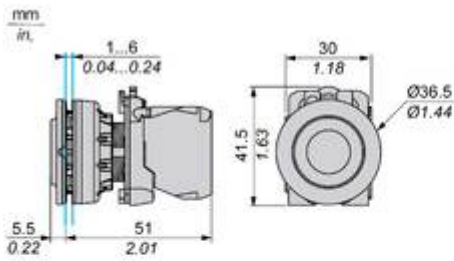

		a (mm)	a (in.)	b (mm)	b (in.)
		40	1.57	40	1.57
ZBE.....	ZBV.....				
		45	1.77	40	1.57
ZBE.....3	ZBV.....3				
		40	1.57	40	1.57
ZBE.....4	ZBV.....4				