

Enclosed switch-disconnectors

20÷80A
2P-3P-3P+N-4P

20÷40A
2P-3P-3P+N-4P

63÷80A
2P-3P-3P+N-4P

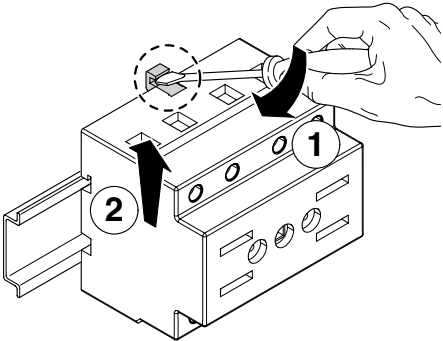
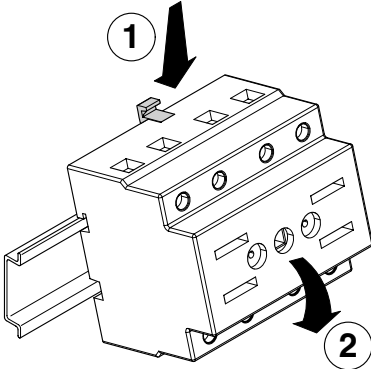
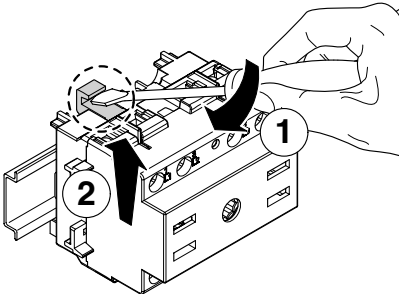
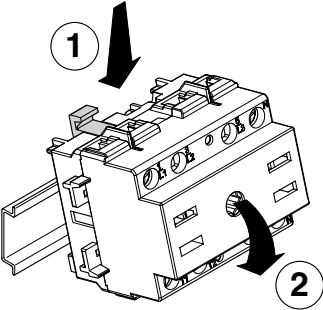

(dimension mm)

ISOLATORS Series

		20÷40A 2P-3P-3P+N-4P	63÷80A 2P-3P-3P+N-4P
Wire range		1.5÷10mm ²	10-35mm ²
Tightening torque	Terminal screws	0.8Nm	3.6Nm
	Fixing screws	1.2Nm	1.2Nm
Wire strip length		10mm	13mm

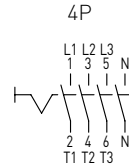
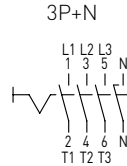
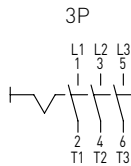
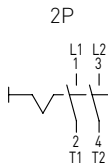

When mounting or removing additional elements the switch **has to be in OFF position** for avoiding damages to mechanism.
When removing main switch following instruction for avoiding damages.

Thermoplastic enclosures

20÷40A
2P-3P-3P+N-4P

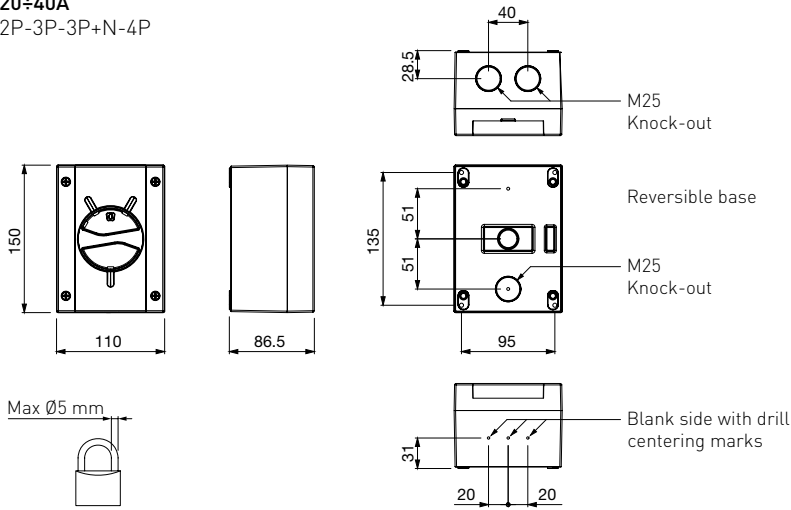

63-80A
2P-3P-3P+N-4P

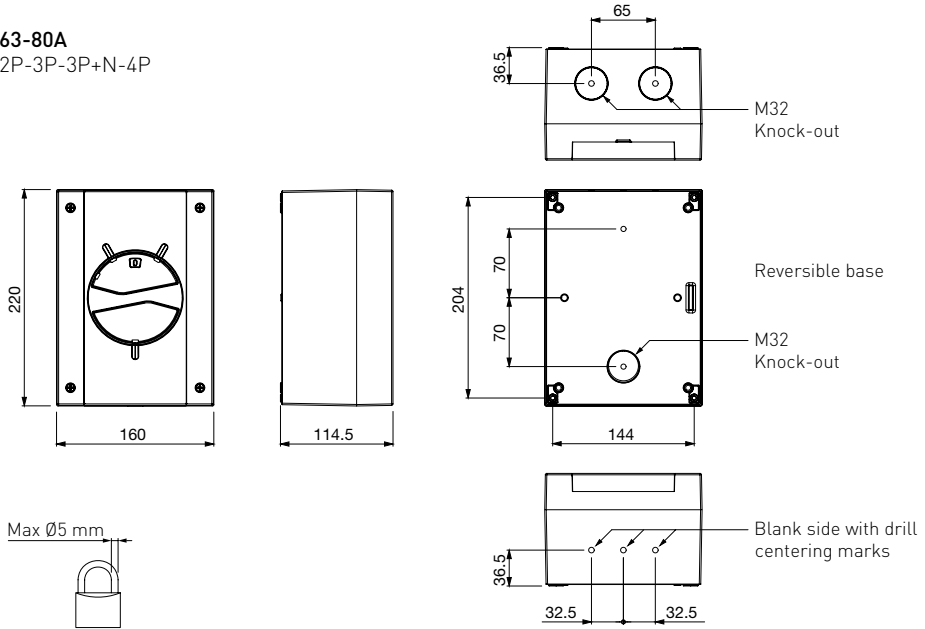

(dimension mm)

Aluminium enclosures

20÷40A

2P-3P-3P+N-4P

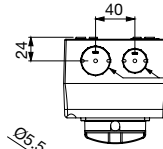
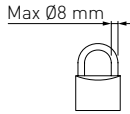
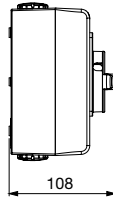
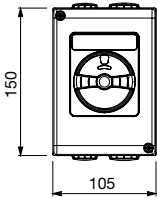

Bottom side

1xM20+1xM25
Open threaded
cable entry
with cap

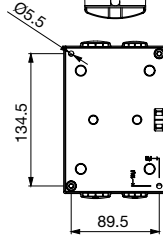

Top side

1xM20+1xM25
Open threaded
cable entry
with cap

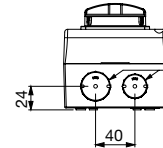

63-80A

2P-3P-3P+N-4P

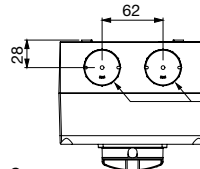
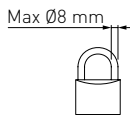
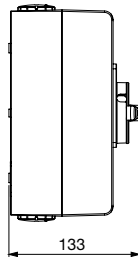
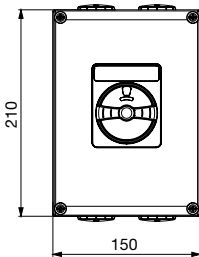

Bottom side

2xM32
Open threaded
cable entry
with cap

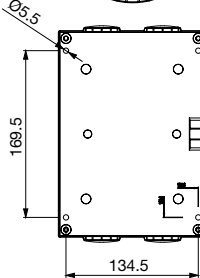

Top side

2xM32
Open threaded
cable entry
with cap

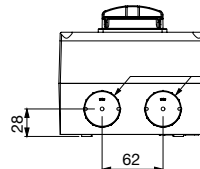

Numero verde
800-018009

www.scame.com
infotech@scame.com