



Link Charger Installation Guide



7.4KW RECESSED SOCKET, PLASTIC CONTROL BOX:

EVLR7PS (7.4KW / WI-FI/ LAN)

EVLR7PSG (7.4KW / WI-FI / LAN / 4G)

Contents

[click to navigate directly to the page](#)

[Introduction/Box Contents](#)

[Installation and Testing](#)

[Domestic Commissioning](#)

[End user App](#)

[Troubleshooting](#)

[Safety Information](#)

[Technical](#)

Introduction

This guide is intended for use by competent electrical installers to explain basic requirements and options to be considered when installing a Sync Energy charger. The unit is designed for installations inside or outside, the advanced safety technology we have built into the unit ensures its safe usage. This guide provides information to assist when installing the EVLR7x chargers and should not be used with other EV chargers.



Control Box



Socket



Box contents

- EV Charger
- Decorative Fascia
- Consumer unit + Control board
- Installation Template + Quick Start Guides
- Accessories pack containing:
 - » Bonded sealing washers
 - » Assembly screws
 - » Anti-tamper bit
 - » 1 x M25 Gland
 - » 1 x CT Clamp (EVA120CT1)
 - » 1 x CT Clamp Connector (for load balancing and Auto Solar Charge feature)
 - » 4 x Rubber Screw caps

Tools required

Hex bit holder, PZ2 screwdriver, suitable drill bit, fixings, 117mm Core Drill, Ethernet crimps and tools.

Electrical Installation - Consumer unit

- 1 Isolate the power.



- 2 Use the included hole template to drill fixing holes.

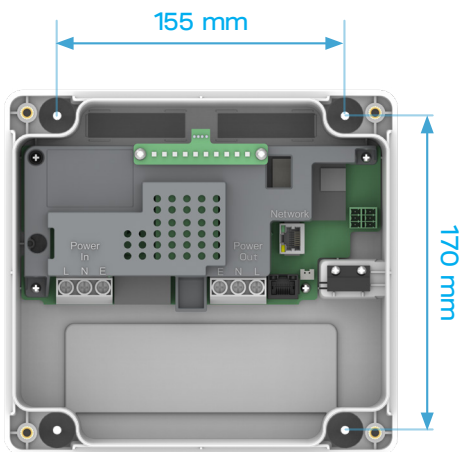

- 3 Select suitable cable entry locations and drill the housing, 3 rear, left/right and 3 bottom cable entry.

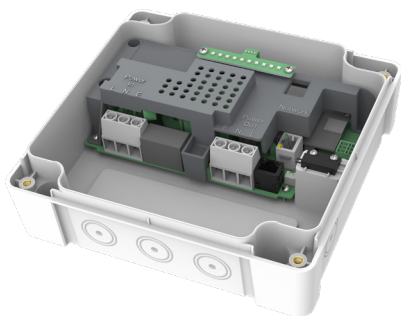

4

Secure Control box to the wall using suitable wall fixing screws.

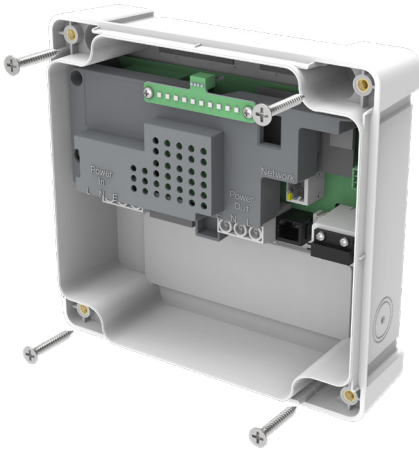

5

Insert the input and output cables and terminate.

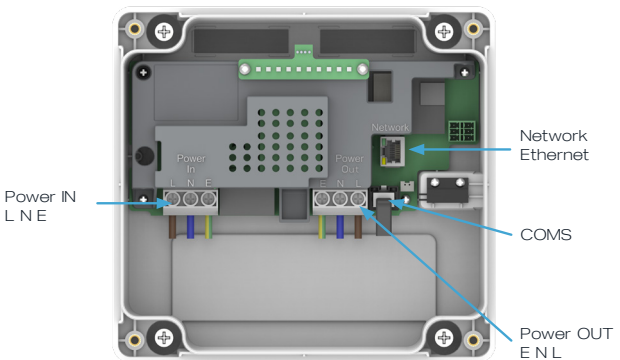

6

For Dynamic Load balancing and Auto Solar charging, connect the CT clamp to the Green connector as shown.

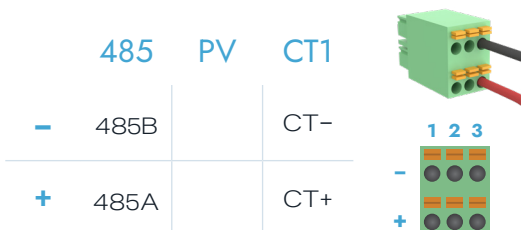

Fit the connector to the PCB, ensuring connector is fully inserted.



7

Once all connections are made, fit the front cover, use the included anti-tamper bit to secure the assembly screws, and fit the screw caps once secure.



Electrical Installation

- Socket Outlet

1

Select suitable location on the wall, Use the included hole template to drill fixing holes and central 117mm cut out. Depending on wall, a smaller secondary hole may be required through the inner wall structure.

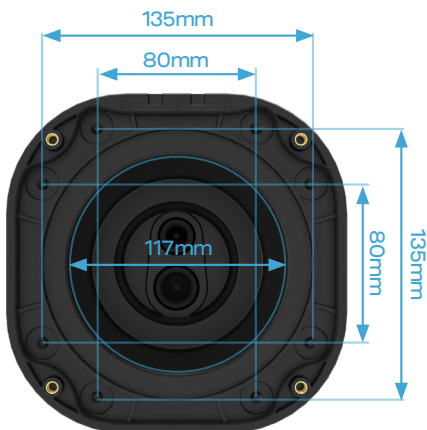

2

Fit cables through the rear cable entries.

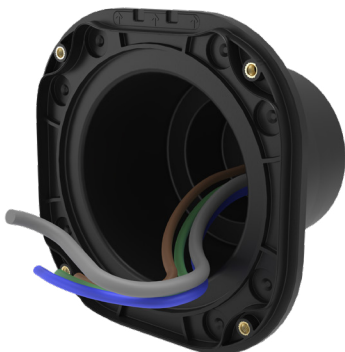

3

Fit housing into cut out, and secure with fixing screws. Ensure sealing washers supplies to maintain IP rating.



4

Terminate cables into the terminals as marked, L - Brown, N - Blue, E - Green/ yellow, coms is RJ45 Ethernet connection to control box.

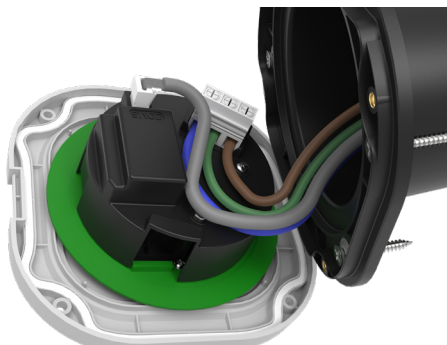

Terminals suitable for 4-10mm² cable size

5

Secure charger body into back box, and tighten assembly bolts using supplied anti-tamper bit.



6

Secure decorative trim, by hooking at the top.



7

Secure trim by fitting retaining screw on the bottom.



Load balancing / Auto Solar Charge Feature

If load balancing and/or Auto Solar Charge feature is required, a single CT clamp should be used for correct balancing. One Sync Energy CT Clamps – EVA120CT1, is supplied in the box with this charger. This should be fitted around the incoming power to the main fuse and the correct max load (A) to be entered during setup and installation steps.

1

Locate the main incoming power cable into the property. The CT Clamp needs to be fitted before any of the tails are split for correct measurement.

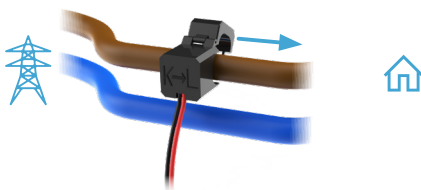

2

Open the CT Clamp and fit around the incoming Live power cable, this is typically marked brown for most installations.

Ensure the Arrow is pointing into the property from the incoming fuse.

K towards Source, L towards Load.

3

CT Clamp current and voltage readings can be checked via the Bluetooth EV installer App to ensure correct connection and orientation.

Domestic Commissioning

INSTALLER APP – [Download the 'Sync Energy' app by clicking this link](#)

Also available from the Installer Portal on the [sync.energy website](#), or using the QR code opposite.



Intuitive Interface: The revamped interface is designed with the installer in mind. Everything you need is available through a new side-menu.

Effortless Setup: seamlessly configure your EV Chargers and Balancer devices with just a few taps. Get up and running in no time.

Account Management: Create and manage your account effortlessly. Keep a history of all your installed Chargers.



Upon powering the charger, the status indicator light will show **Yellow**. This indicates that the charger is ready for network setup but is not yet connected to the internet. These steps are still required for 4G connected versions for setting of Dynamic Load Management.

For Wi-Fi connection, we recommend that the router is set to only 2.4GHz band to reduce the risk of possible conflicts. Once setup the router can be restored to both 2.4Ghz & 5Ghz bands.

1

Open the Sync Energy Installer App, If this is the first time you will be required to create an account.

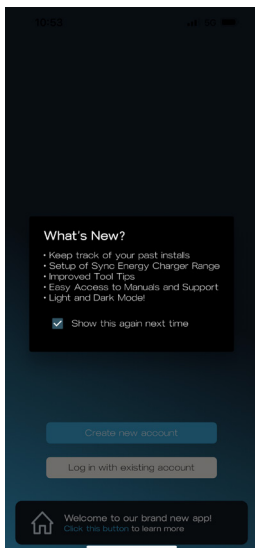

Select account type:
The installer should choose the Installer account type. The customer / user of the charger should also download the app, and select "Home User" as their account type.

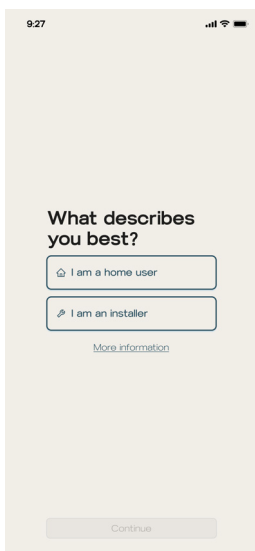

2

The installer should ensure Bluetooth is activated on your device and select set up new product. If the EV charger does not show up under EV Charger option, go back and select show all Bluetooth devices. If no Bluetooth devices are shown, please check Bluetooth is turned on and the permission was granted in the app.

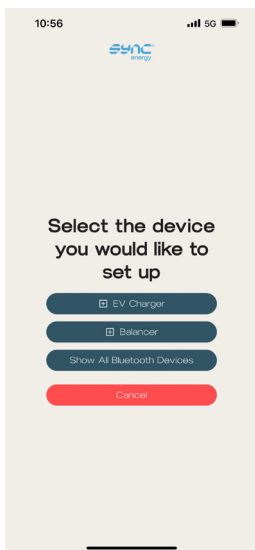

3

Select the correct EV Charger that matches the Charger ID code as shown on the charger identification label.

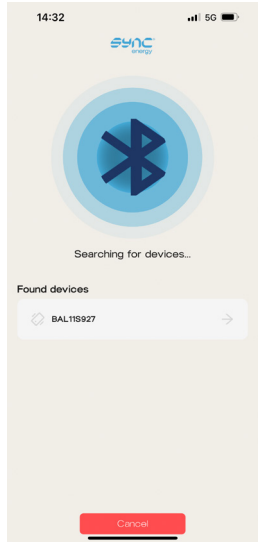

4

Then enter the password/PIN shown on the identification label.



5

Depending on firmware version installed at the charger at the point of installation, you may see a different homepage in the App.



- Full EV Charger Setup allows full set up of Load balancing and other settings.
- Network Set up allows quick Wi-Fi or Lan connection to be changed and set up

6

Charger Server:

Select "Sync Energy"
– this is the included App.
"Monta", "Ev.Energy" and
"SyncEV" are alternative
options (additional costs
may be incurred). "Manual"
can be used for other
alternative back offices.
If unsure, choose
"Sync Energy".

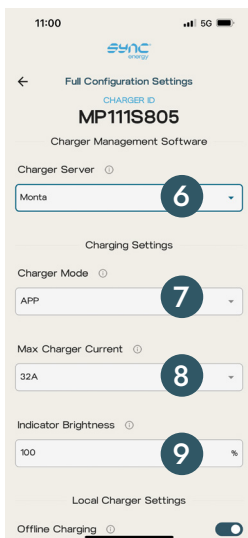

7

Charger Mode: "APP" for smart charging via the consumer App (see next page); "Plug and Charge" if connection to the server cannot be established and immediate car charging is required.

8

Max Charger Current: Set to max current supported by installation if less than the default 32A.

9

Indicator Brightness: Adjust from 1 to 100% to change the brightness of the status indicator.

10

Local Charger Settings:

Offline charging is enabled as default, for commercial paid charging we recommend this is disabled. This controls if the charger will allow a charge to start while not connected to the back office system.

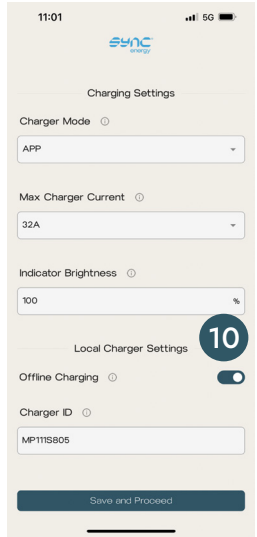

11

Charger ID can be changed as required for other user Apps. We Recommend this is not changed unless critically required. Press Save and Proceed to the save these settings.

12

Dynamic Load Management:

If Dynamic Load management or Auto Solar Charge is required, then toggle right and select Single CT Clamp. Enter the properties fuse or maximum circuit rating. This will reduce the charge rate if the property is near the set limit.

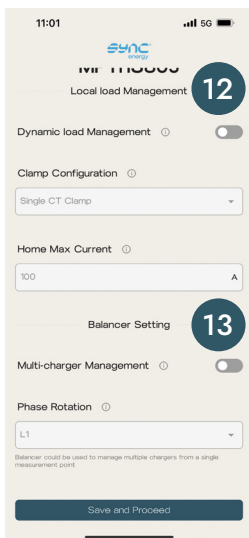

13

Balancer: This should be enabled if using the Balancer Multi-Charger hub, and then the correct phase rotation enabled. Circuit limits are set on the balancer unit only. Press Save and Proceed to save these settings.

Check the shown electrical measurements match the measured readings. This will allow checking the load management CT is fitted in the correct orientation and location. A negative value indicates reverse direction of power due to, e.g Solar surplus, but could also indicate that the clamp has been installed in a reversed (incorrect) orientation or polarity wiring.

If it shows up as "Check CT Clamp", check connections.

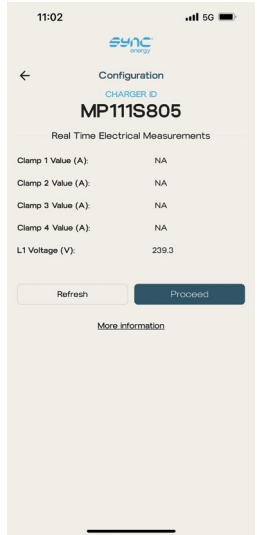

Network Set up

15

For connecting to the network, ensure the required connection method is enabled. Choose between Wi-Fi, 4G (where supported) and LAN.

- For Wi-Fi, select the SSID network name and enter password,
- For LAN, ensure that "Manually Set Static IP Address" is disabled (unless advanced settings are required)
- For 4G, the settings will have been pre-configured where supported. (EVLxxSG models only)

Multiple options can be selected if required, this will allow a fall-back, e.g from Wi-Fi to 4G if fitted in case of network loss.

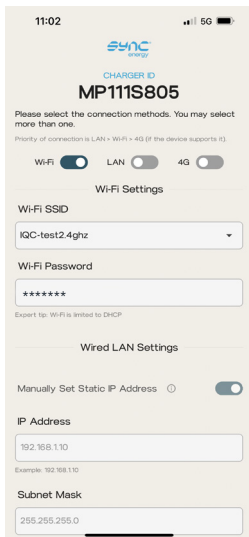

16

On LAN, the charger will default to DHCP. If static IP is required for the network connection, set the option "manually Set Static IP Address" to On and a manual IP address can be entered.

17

Press Save and Proceed to start network connection.

18

The Charger will attempt a network connection, if successful will then reboot to complete safety function check.

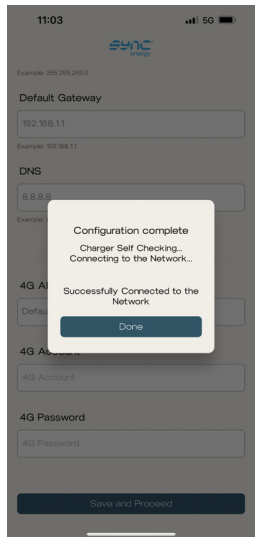

Once the chargepoint has been installed, select "Transfer / Share with another user"

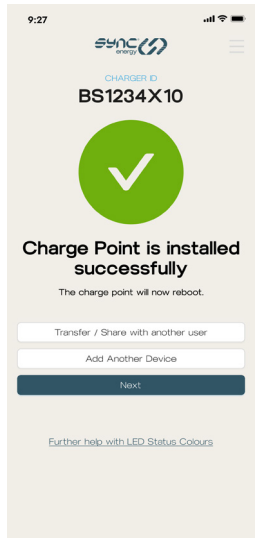

You can now transfer the charger to the home user by scanning their import QR code, or entering their Sync Energy account email address. You can alternatively transfer it from Installation History screen.

If the customer / home user is not present, they will simply need to scan the QR code on their "Getting Started Guide", when it is convenient to them.

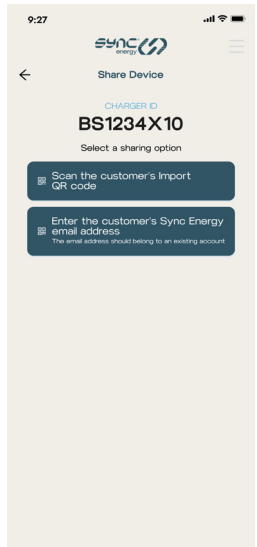



In less than 2 minutes, the indicator should turn from Yellow to Blue to confirm network connection.

If the charger continues to show yellow, power cycle (switch off/on at fuse board) and reconnect via the app to check the settings are correct.

If still unable to connect to the network but need to use the charger then change the Charge Mode to 'Plug and Charge' and press 'SET' again to re-update settings.

If unable to establish network connection call [01952 983 940](tel:01952983940)

or email: support@sync.energy

Note: The network connection from the device to the Internet is fully encrypted and secure. Additionally, no user data is stored on the charger.

Home User EV Charger Control

1. Ensure the EV Charger has been imported to the home-user's Sync Energy app, by following the previous step(s) (refer to the numbering on the previous final step).
2. The home screen shows the available EV Charger(s). Press on it to start controlling it.

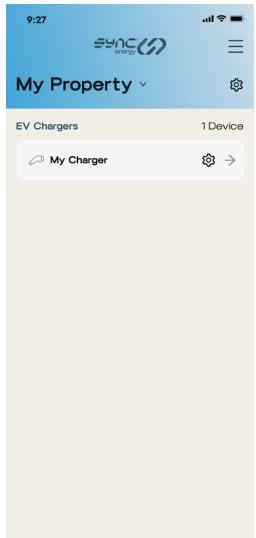

- 1 Main Menu
- 2 Charger Settings
- 3 Add an of your car (optional)
- 4 Charger Status
- 5 Start time of the next scheduled charge
- 6 Charge immediately*
- 7 Enable a schedule
- 8 Enable solar charging
- 9 Start charging automatically when a car is connected*

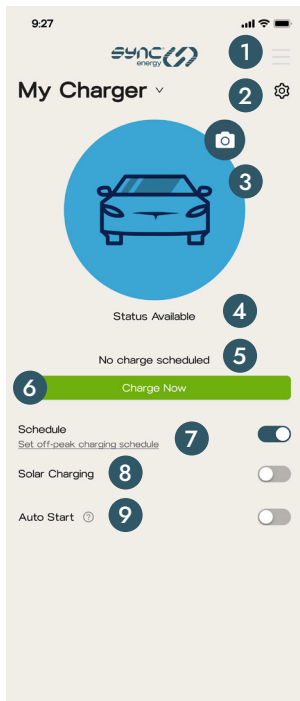

*Randomised starting delay will be applied, and it can be overridden if required.

Need help?

Contact Sync Energy technical support at:

support@sync.energy

or via the website at:

www.sync.energy

Troubleshooting

For further information, or to refer to our FAQs, please visit our website: www.sync.energy

The status of the EV charger can be identified by referencing the colour shown on the LED indicator:

- **Solid Blue – Standby** – Charger has power and is connected to the network. Or, if in 'plug and charge' mode is not connected to the network, is ready to charge.
- **Flashing BLUE** – Charger is connected but not charging, awaiting confirmation of charge in APP or scheduled start time
- **Scrolling Dark Green** – Charger is active and Charging
- **Flashing Dark Green** – Finishing, Charging session has finished
- **Solid Yellow** – Charger is offline from network, check local network is active and Wi-Fi is working on the 2.4Ghz band
- **Flashing Red** – Indicates the charger is in fault mode and has stopped charging for users safety
- **Flashing Purple** – Communication issue to Balancer hub, or Balancer load management set to on by mistake. Check installer App settings
Potential causes:
 - Vehicle fault
 - Under or over suitable charging voltageRemove connection to the vehicle and reset power to the EV charger.

Commercial / Workplace / Fleet installation & commissioning

4 simple steps:

1 CONTACT

Email commercial@sync.energy with the charge-point owner contact details

2 CONNECT

Install the charge-points

3 CONFIGURE

Set the configurations in the Sync Energy App Installation set up to Monta for Server URL, and connect all chargers to the Internet.

4 COMPLETE

Pass the charger details to the charge-point owner

How it works:

To streamline the process, email us [before the first day of installation](#) with the following information:

- **Model and charger ID**
(for every charger in the installation)
- **Contact details for the charge-point owner:**
 - Company name
 - Name of charge-point manager
 - Site address
 - Telephone number for charge-point manager
- Email address for charge-point manager
Our Commercial Team will contact the charge-point owner to carry out the quick and simple Monta setup process.

By using this process we will have the back-office set up for installation day, ensuring all chargers are immediately ready for customer use once configured.

Load Balancing Multiple chargers

If load management for more than 1 charger is required please see EV Balancer at sync.energy for more details on how to dynamic load manage up to 16 chargers at once.

MID Meter For Billing Purposes Only

If a MID Meter is required for Billing purposes – chargers can communicate on the RS485 connection, this will require the DIP switches to be set for this. DIP 3 Up/On is required as default will be off.

Final Electrical testing

To meet the BS7671:2018 (18th edition) requirements for testing of an electrical installation, the following tests and checks shall be performed by a competent electrical installer before during and after a Sync Energy charger is installed:

- A visual inspection of the installation including the existing electrical installation.
- Verification of the characteristics of the electrical supply at the origin of the installation to confirm the supply is suitable for the additional load.
- A test to confirm the continuity of the circuit protective conductors.
- A test to confirm the integrity of the circuit insulation resistance.
- A test to confirm the polarity of the installation is correct.

- Where applicable a test to confirm the earth electrode resistance is within acceptable tolerances.
- (or)
- An earth loop impedance test.
 - A test or calculated measurement of the prospective fault current.
 - A verification of the functional operation of the EV charger.
 - An electrical installation certificate must be completed.

Ensure electrical testing is done before EV charger commissioning and network setup is performed.

For this testing, the Charger can be set to **"Plug and Charge"** Mode or Installation Mode can be enabled in the installation App.

Safety information

Warning: The supplied Sync Energy charger is manufactured to be safe without risk provide they are installed correctly, used, and maintained in accordance with the manufacturers recommendations and installed by a competent electrical installer in accordance with national and local regulations and legislation applicable at the time of installation, e.g. BS7671:2018 amendment 2.

The EV Charger is suitable for use with a single phase (for up-to 7.4kW charging) 220-240V Nominal AC supply.

The product includes 6mA DC leakage detection.

Earthing requirements

The supplied EV charger features an on-board safety monitoring system to detect low or high voltage supplies and potential earth-neutral faults, this in accordance with regulation 722.411.4.1 (iv) of BS7671 2018. If such a condition is encountered the charge cycle is ended or prevented and the EV charger indicator flashes red and effectively becomes a double insulated (class II) device. The vehicle becomes isolated in accordance with Regulation 543.3.3.101(ii) from incoming supply and poses no risk to touch. This feature removes the requirement for an earth electrode where it may be ineffective or introduce further risk.

The EV charger may be connected directly to a TN-C-S (PME) earthing system without any special arrangements. It remains the responsibility of the installer to conduct a risk assessment

of the immediate area to a range of 10 meters (equipotential zone) to ensure no other conductive metal fixings pose risks (mixture of TT/TN-S and TN-C-S), this is important where cable length may enable charging inside or outside of a building/ garage where the vehicle is within touch distance.

Where certain conditions dictate an earth electrode must be used it shall be independent from the distributors earth system with no direct interconnection (the incoming supply SWA protective earth should be isolated from the housing and/ or earth electrode). The electrical installer shall install a suitable electrode complete with termination housing and covers where appropriate, warning labels should be visible and close to the unconnected SWA protective earth, e.g. inside the charger.

The earth connection shall be made from the electrode to the charger via copper conductor earth wire of an appropriate CSA for the installation. The earth wire shall be installed in conduit where there is a risk of mechanical damage or UV exposure. Recommended Earth electrode impedance to be <100 ohms.

Isolation and switching for safety and maintenance

An isolator switch is a mandatory requirement for "new builds", but optional for existing dwellings (at customer's request), the switch should be mounted between 500mm and 1500mm above finished floor level to comply with regulations. The switch should be rated at 40 Amps. All installations must comply to BS7671: 2018.

Installation requirements

The EV charger is suitable for installation inside and outside on a solid wall or structure.

The installer should consult with the building owner to establish their preferred installation location.

This should take into consideration the length of charging cable and risk of vehicle impact etc.

It is recommended the charger is installed at a height of 500mm-1500mm as per building regulations BS8300:2018.

Ensure suitable fixings are used depending on the mounting surface. To avoid unnecessary dust inside the enclosure, it is recommended to use the included fixing hole template drill the surface, before fitting the enclosure.

Ensure installation wall has been checked for electric cabling or pipework with a suitable detector.

NOTE: if any groundworks are required e.g. cable trenching or earth electrode fitment, it is advisable to check if underground services could be present before commencement. Plans may be available at: www.linesearchbeforeudig.co.uk (free to domestic users).

The EV charger is suitable for bottom or rear cable entry, if using rear cable entry ensure the included 25mm rubber grommet is used to maintain the IP rating.

If using SWA cable the included 25mm compression gland is NOT suitable, an alternative gland will be required.

Its advisable to earth the SWA armouring at the supply end of the cable.

Do not drill alternative cable entries into the charger housing, except marked cable entry location for rear or bottom entry.

We Recommend using EV Ultra or other combined power + Ethernet Data cable between Control box and outlet.

All of the cables that are to be connected in to the supply connector should have their insulation striped back 18-20mm. Connectors supplied are suitable for cables of 4-10mm².

Technical information

Environmental Protection



This symbol is known as the "Crossed-out Wheellie Bin Symbol". When this symbol is marked on a product or battery, it means that it should not be disposed of with your general household waste. Some chemicals contained within electrical/electronic products or batteries can be harmful to health and the environment. Only dispose of electrical/electronic/battery items in separate collection schemes, which cater for the recovery and recycling of materials contained within. Your co-operation is vital to ensure the success of these schemes and for the protection of the environment.

Guarantee

Sync Energy products are guaranteed against faulty materials and workmanship for a period of 3 years from date of delivery: products will be repaired or (at Sync Energy's discretion) replacements will be supplied or (at Sync Energy's discretion) a credit note will be issued.

This guarantee is subject to Sync Energy's conditions of sale and in particular to the following conditions being met:

1. Notification of any defect is given to Sync Energy as soon as reasonably practicable after becoming apparent, and the products then returned to Sync Energy.
2. The products have only been operated under normal operating conditions and have only been subject to normal use.
3. No work (other than normal and proper maintenance) has been carried out to the products without Sync Energy's prior written consent.
4. The products have been assembled, or incorporated into other goods, by a qualified and recognised electrician and only in accordance with any instructions issued by Sync Energy.
5. The defect has not arisen from an item manufactured or supplied by a person other than Sync Energy.
6. 3 year warranty as standard, optional product registration can be completed on the Sync Energy website.

[Follow this link to visit our Warranty web-page](#)



Technical data

ELECTRICAL SPECIFICATIONS

MAXIMUM CHARGE CURRENT	Configurable, 6-32A
INPUT FREQUENCY	50-60hz
PEN FAULT	Built-in, Earth Disconnection
POPULATED WITH	1 x 40A 30mA Double Pole
MAX DISTANCE FROM CONTROL BOX TO OUTLET	50m
CONSUMER UNIT REQUIREMENTS	None
LOAD BALANCING	Supplied with Load Management Kit
OVERLOAD AND FAULT PROTECTION	Over current and over voltage protection
METER ACCURACY	2% Class C equivalent internal meter with option for connection to external RS485 MODBUS Meter
TERMINALS	Combi Screw
INDICATOR	Control Box and Outlet Halo - RGB LED and Buzzer
INDICATOR MODES	BLUE – Standby, FLASHING BLUE – Preparing, FLASHING GREEN – Finishing, SCROLLING GREEN – Charging, YELLOW – No Network, RED – Error, PURPLE – Balancer Error
ANTI-TAMPER DETECTION	2 Layer Protection, Bluetooth to Bluetooth commissioning

CONNECTIVITY & ACCESSORIES

SOC MODULE	AI ESP32-S3 SOC
WI-FI & ETHERNET	2.4Ghz 802.11 B/G/N & RJ45
WI-FI SECURITY	WPA/WPA2/WPA2-ENTERPRISE/ WPS
BLUETOOTH	4.2 BR/EDR and BLE
CONNECTION PROTOCOL	OCPP 1.6J
4G DATA	Model specific 3 years included when used with Sync Energy (on the included package). Top-up online to continue service after 3 years.
APP	Powered by Sync Energy
SOFTWARE & FIRMWARE UPDATE	Over-the-air
STANDARDS & APPROVALS	IEC61851-1, IEC61439-7, IEC 62955, IC 61851-21-2, BS EN62196, EN301 511, EN 301 908-1/2/13, EN 301 489- 3, EN 300 330, EMC COMPLIANT, CE, UKCA, The Electrical Vehicles (Smart Charge Points) Regulations 2021 including schedule 1
SUPPLIED ACCESSORIES	Recessed - 5X base fixing washers, 5X assembly lid bolts Surface - 5X assembly Lid Bolts, 1X blanking plug, 1X 25mm compression gland, Cord grip and 2X cord grip assembly screws

OPERATING CONDITIONS & CONSTRUCTION

OPERATING	-25 to +55°C
IP RATING	IP65
IK RATING	IK10
MOUNTING	Control Box - 155 (W) x 170 (H) - 4 points Outlet Recessed - 80 x 135 or 135 x 80 - 4 points Outlet Surface - 100 (W) x 80 (H) - 3 points
HOUSING	Control Box - Polycarbonate Outlet - Die Cast Aluminium
COLOUR	Control Box - RAL 7016 Outlet - RAL 9007
DIMENSIONS	Control Box - 213 (W) x 198 (H) x 65 (D) Outlet Recessed - 176 (W) x 176 (H) x 37 (D) Outlet Surface - 176 (W) x 176 (H) x 122 (D)

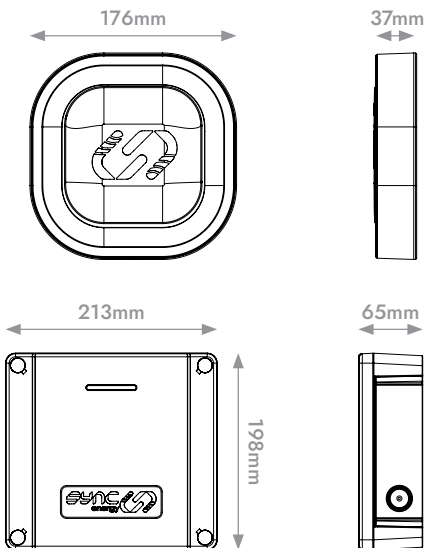

Technical support

Need help with the [app](#)?

Contact our UK technical support team at :

Phone: [+44 1952 983 940](tel:+441952983940)

Email: support@sync.energy

Opening hours

8:30 - 17:00 Monday - Thursday

8:30 - 16:00 Friday

Answer phone facilities for out-of-hours enquiries

or via the website at www.sync.energy

**Sync Energy (previously Sync Energy)
is a trading name of Luceco PLC**

Luceco PLC

Stafford Park 1, Telford, TF3 3BD, England

(EU) Luceco SE

C/ Bobinadora 1-5, 08302 Mataro, Spain