

Product Code: CU2RCBO63B

Description: Double Pole True 6kA B Curve 63A 30mA RCBO

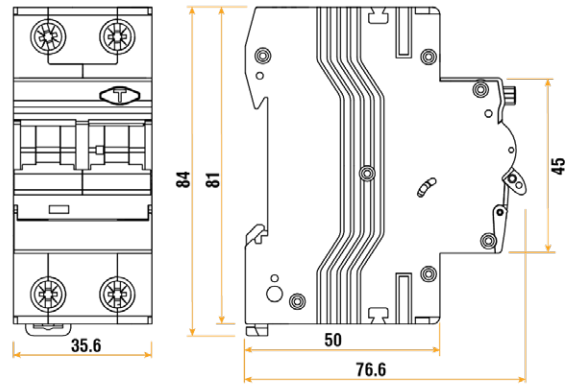

**General Information**

Dimensions (mm)	35.6 (W) x 84 (H) x 76.6 (D)
Finish	Light Grey (RAL 7035)
Rated Operational Voltage (V~) (Ue)	230
Frequency (Hz)	50/60
Maximum Rated Current (A) (In)	63
Rated Breaking Capacity (True kA) (Ics)	6
Impulse Withstand Voltage (Uimp)	4000
Endurance Mechanical Operations	10000
Endurance Electrical Operations	4000
Type	A
Trip Curve	B
Rated Making & Breaking Capacity (A) (Im)	500
Tripping Current (mA) (in)	30
Residual Non-Operating Current (IΔn)	0.5
Trip Type	Ground Fault: Electronic Over Current: Thermal/Magnetic
Device Terminals	Screwed Lug & Pin
Number Of Poles	2
Input Terminal Capacity - Flexible (mm²)	16
Input Terminal Capacity - Rigid (mm²)	25
Input Terminal Torque (Nm)	2
Output Terminal Capacity - Flexible (mm²)	16
Output Terminal Capacity - Rigid (mm²)	25
Output Terminal Torque (Nm)	2
Circuit Protection	Earth fault, overcurrent & short-circuit
Ingress Protection	IP20
Operational Temperature (°C)	-25 to +40
Warranty (Years)	3

**Standards** BS EN 61009-1

