

CM-IWM.11

Insulation monitoring relay

The insulation monitor CM-IWM.11 provides best and up to date insulation monitoring of modern IT systems in an optimum and state of the art way fulfilling the relevant standards. The device can be used in the most flexible way for AC, DC and AC/DC systems even with large leakage capacity to earth (PE). The adjustment of the setting values is simple and user friendly done on 2 rotary switches on the front of the device. Via LEDs the measured value, device parameters and device status are indicated easy to read.



2CDC 251 003 S0016

Benefits

- Preventive fire and system protection
- Quick fault localisation through selective earth fault detection to L+ and L-
- Universal application in non-earthed DC / AC and mixed IT networks with maximal up to 1500 V measurement voltage
- Suitable for large earth leakage capacitances up to 3000 μ F
- Simplest setting via engaging rotary switches
- For monitoring photovoltaic system, also with thin-film technology
- Optimised measuring times – normally shorter than with known methods
- Monitoring also with voltage-free mains
- Measuring circuit with broken wire detection
- No additional coupling device required

Characteristics

- Insulation monitoring according to IEC/EN 61557-8
- Detection of symmetric and asymmetric insulation faults
- Measuring circuits can be disconnected via control terminals, e.g. for mains couplings
- 1 c/o contact each for prewarning and warning
- Prewarning threshold setting range: 20 k Ω ... 2 M Ω
- Warning threshold setting range: 1 k Ω ... 250 k Ω
- Open- or closed-circuit principle configurable
- Setting the maximum earth leakage capacitance to shorten the response time
- Simple, clearly arranged adjustment of the device with screwdriver
- LED chain to indicate the current insulation resistance
- Display of active measuring circuits
- Automatic and manual device self-test
- Alarm storage selectable
- External test and reset pushbutton can be connected
- Width 90 mm
- Various certifications and approvals (see overview, document no. [2CDC112250D0201](#))

Order data

	Type	Order code	Weight (1 pc.) kg (lb)
Insulation monitoring relay	CM-IWM.11	1SVR470670R1100	0.50 (1.10)

Application / monitoring function

Insulation monitoring of:

- Non-earthed DC / AC and mixed IT networks
- UPS systems
- Networks with frequency inverters
- Battery networks
- Networks with direct current drives
- Photovoltaic systems
- Hybrid and battery-powered vehicles

The CM-IWM serves to monitor insulation resistance in accordance with IEC/EN 61557-8 in unearthed IT AC systems, IT AC systems with galvanically connected DC circuits, or unearthed IT DC systems.

The insulation resistance between system lines and system earth is measured. If this falls below the adjustable threshold values, the output relays switch into the fault state.

When applying control supply voltage the green LED „PWR“ turns on and an internal selftest of 10 s starts, where the LEDs of the indicator string light up in sequence. After this, measurement of the insulation resistance in the measuring circuit begins.

Insulation measurement between terminals L(+) / L(-) and PE / KE

Terminals L(+) and L(-) are connected to the mains to be monitored. Broken wire detection, constantly effective during operation, generates an error messages if both terminals are not connected with low resistance through the mains.

In addition, the two terminals PE and KE must be connected to the protective conductor system via separate lines. An error message is given here as well if a line is interrupted (see section „Actions in case of connection faults“).

If the main measuring circuit is activated (terminal HM open), an active measuring voltage with alternating polarity is applied between L(+) / L(-) and PE / KE to measure the insulation resistance. During the measuring phase with positive polarity, the "HM" LED flashes with a long ON-phase and with negative polarity with a short ON-phase. The "HM" LEDs goes off when the main measuring circuit is switched off through bridges of terminals HM-G. Measurement is suspended and no more measuring voltage reaches the measuring circuit, so that in case of coupling to a network where another insulation monitor is already active, no interference can occur.

The length of the positive and negative measuring phases depends on the settings on the rotary switch "CE/μF", the actual leakage capacitance of the monitored network and with DC networks, on the level and duration of possible mains voltage fluctuations. Correct and preferably quick measurement is thus given with different mains conditions. In the event of particularly adverse conditions and major interferences, the measuring analysis can be steadied and delayed in addition with rotary switch "tv" if necessary.

The current insulation resistance is determined and analysed at the end of each measuring phase. The LED-chain shows the resistance determined, and the output relays for prewarning "VW" and alarm "AL" switch according to the respective response values set. If the response thresholds have been undercut, the LEDs "VW" or "AL" light according to the insulation fault location: "+", "-" or "+" and "-" simultaneously for AC faults or symmetric insulation faults.

Storing insulation fault message

If terminal R is open, the insulation fault messages (relay, LEDs) are stored when the respective response value is undercut, but also when the insulation resistance returns to the OK-range. In addition, the temporary minimum values of the insulation resistance are indicated on the LED chain through dimmed LEDs.

If the "Reset" button on the device front is pressed or terminal R is connected with G, the stored insulation fault messages are reset when the insulation resistance is again in the OK-range.

Output relay for insulation fault messages

The rotary switch "CE/ μ F Rel." allows selecting the open circuit (A) or closed circuit (R) operation for the output relays "AL" (contacts 11-12-14) and "VW" (contacts 21-22-24).

With the open circuit operation, the relays respond when the response values are undercut, with the closed circuit operation they release when the response values are undercut.

If 2 different response values are not needed, "VW" and "AL" can be set to the same value. The output relays switch together in this case ("2u").

Broken wire detection

As mentioned above, all terminals of the measuring circuit are constantly monitored for wire breaks - not only at Power-On or a manual or occasional automatic test. The response time of monitoring is only a few seconds.

Broken wire detection between L(+) and L(-) is performed via coupled alternating voltage. This alternating voltage is short-circuited if the terminals are connected to the connected mains at low-resistance. The device detects that the mains to be monitored is properly connected. Since this broken wire detection is carried out with alternating voltage, large earth leakage capacitances should be avoided between L(+) and L(-), since the capacitive reactance of these capacitances also short-circuits this alternating voltage. The device would no longer detect a connection fault on L(+)/L(-). Especially parallel lines should be prevented over larger distances.

Device test functions

Principally, 2 different test functions are implemented: The "self-test" and the "expanded test":

The self-test of the device is performed automatically after Power-On and every 4 operating hours. It can also be triggered manually at any time by pressing the "Test" button at the device front or with an external pushbutton connected between terminals T and G.

With the self-test, contrary to the expanded test, the status of the output relays is not affected; the sequence is as follows. Switching to the negative measuring phase is performed for 4 s. The "HM" LED flashes $\square\square\square\square$ and the LEDs of the LED-chain are selected in sequence and the internal circuit is checked. After this, switching to the positive measuring phase is performed for 4 s. The "HM" LED flashes $\square\square\square\square$ and the LED-chain cycles again and additional internal tests are performed. Insulation measurement continues normally after a pause of 2 s if no faults have occurred.

The expanded test is started when the internal or external "Test" button is pressed (or is still held) at the end of the 8 sec self-test, described above. The sequence is the same as with the self-test (2 measuring phases at 4 s + 2 s pause); however, the output relays "AL" and "VW" as well as the associated LEDs switch to the alarm state.

If the Reset button is pressed during the 8 s or terminals R-G are connected, the expanded test is terminated after these 8 sec. Otherwise, the phases of the expanded test are constantly repeated, and, in addition, the "ERR" LED is on. However, the expanded test is terminated as soon as the Reset button is pressed. The device switches to the OK-state and restarts insulation measurement.

Behaviour with internal device faults

If internal device faults were detected during the test function, the LED „ERR“ is lightening and the measuring circuit is deactivated internally. The LED „HM“ turns off. The output relays „AL“ and „VW“ as well as the corresponding LEDs switch to the alarm state and all LEDs of the LED chain turn off.

Behaviour with connection faults

Measurement is suspended if a line interruption is detected at terminals L(+) / L(-); the LED „HM“ turns off. This broken wire detection is signalled by flashing $\square\square$ of the LED „ERR“. The output relays „AL“ and „VW“ as well as the corresponding LEDs go into alarm state and all LEDs of the indicator LED chain turn off.

Measurement of the connection insulation resistance restarts after the connection interruption has been corrected. However, stored alarm messages are preserved.

If the connections PE/KE to the protective conductor system are interrupted, the same responses take place as with an interruption at terminals L(+)/L(-), only that the LED „ERR“ flashes differently: $\square\square\square$.

Technical diagrams

Function diagram

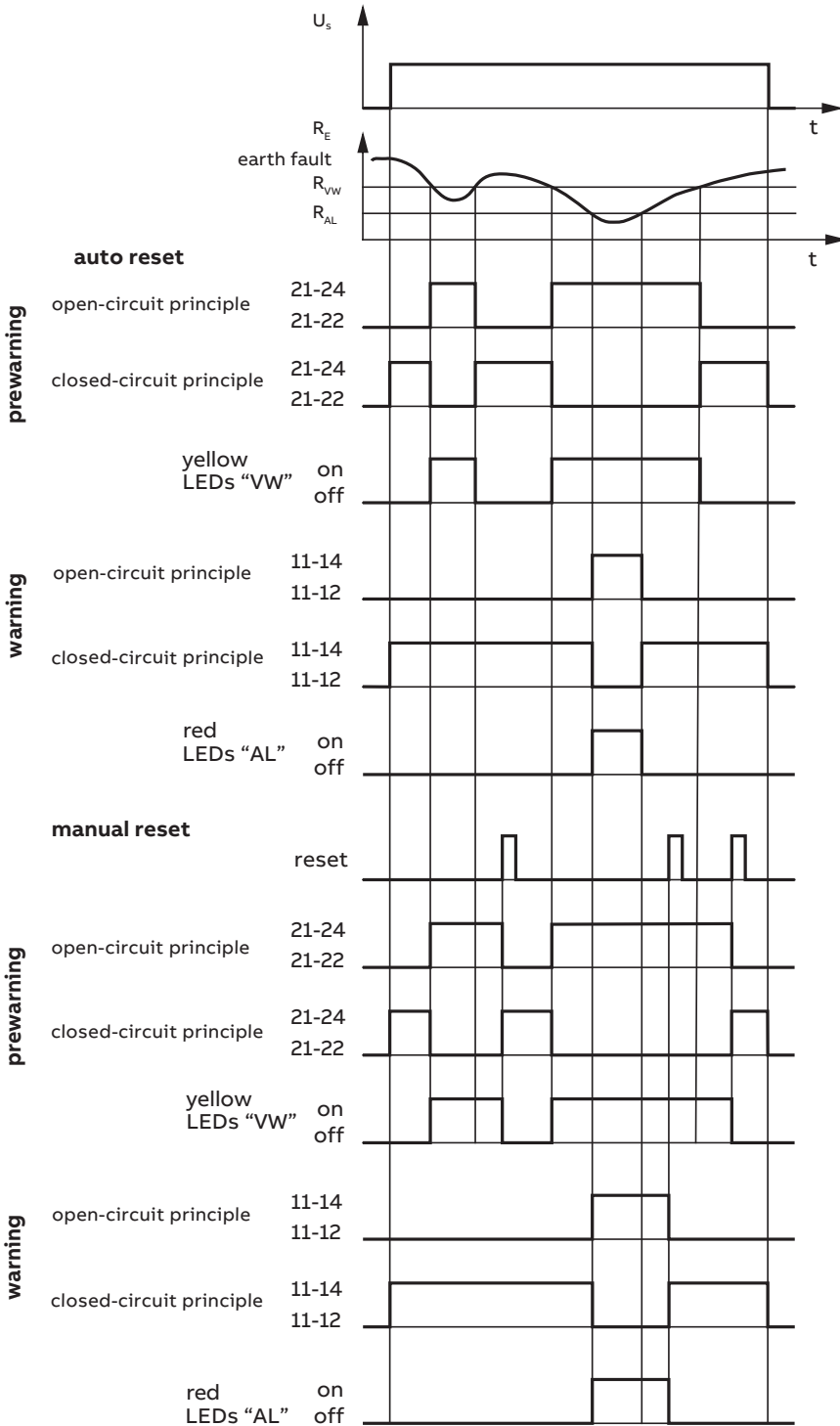

2CDC252 008 F0016

Technical diagrams

Electrical connection

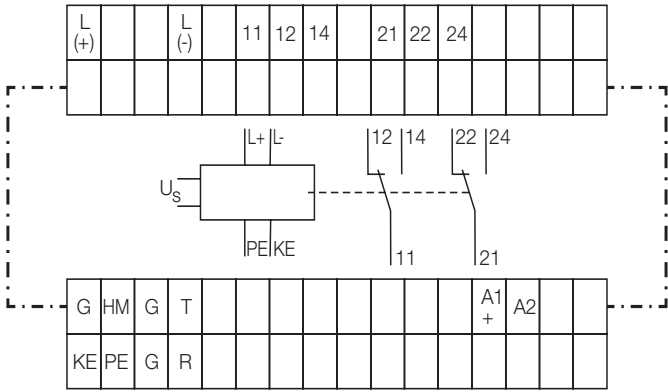

2CDC 252 012 F0016

Terminal designation	Signal designation
A1+, A2	Control supply voltage
L(+), L(-)	Connection for measuring circuit
KE, PE	Connection for protective conductor
G, R	Control input (manual/auto reset) G/R not jumpered: manual reset G/R jumpered: auto reset
G, T	Control input (External test input) connection for an external device test pushbutton
G, HM	Control input (measuring circuit deactivation) G/HM not jumpered: measuring circuit activated G/HM jumpered: measuring circuit deactivated
11-12/14	Output relay 1 (warning)
21-22/24	Output relay 2 (prewarning)

Connection examples

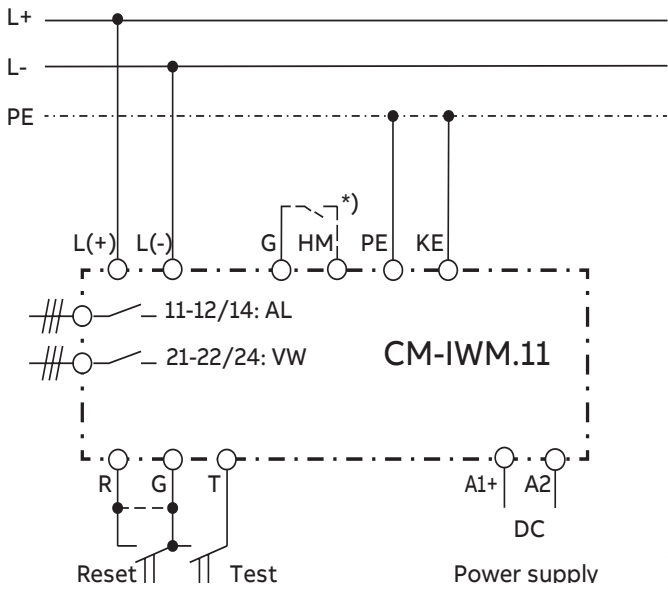

2CDC 252 006 F0016

Example of a DC application

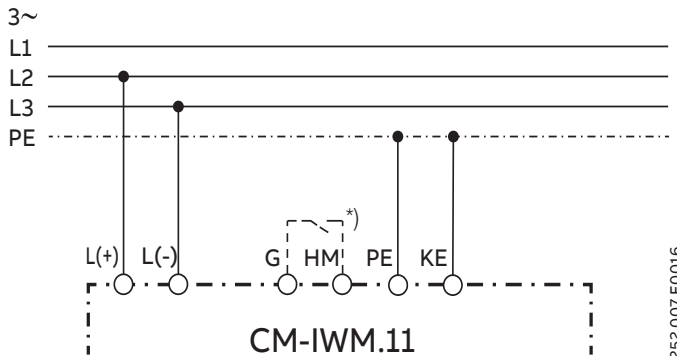













Example of a AC application

2CDC 252 007 F0016

*) G-HM connected: Measuring circuit is off

Operating state indication

LEDs, status information and fault messages

PWR: green LED		control supply voltage applied
ERR: red LED		internal device error
		connection error L+/L-
		connection error PE/KE
HM: green LED		measuring phase with positive polarity
		measuring phase with negative polarity
LED chain: yellow LED		8 LEDs indicate the current insulating resistance ($\leq 10 \text{ k}\Omega \dots \geq 2 \text{ M}\Omega$)
VW +: yellow LED		R_E lower than prewarning value to + potential
VW -: yellow LED		R_E lower than prewarning value to - potential
VW + and VW -: yellow LED		AC fault / symmetric fault
AL +: red LED		R_E lower than warning value to + potential
AL -: red LED		R_E lower than warning value to - potential
AL + and AL -: red LED		AC fault / symmetric fault

Safety instructions



Warning!

Risk of electrocution! Danger to life or risk of serious injuries

- Disconnect the system and device from the power supply and ensure they remain disconnected during electrical installation.
- The voltage of the monitored voltage system is connected to terminals L(+) / L(-). Please observe sufficient distance to terminals of neighbour devices and to the grounded metal cabinet or box (min. 0.5 cm).
- The terminals of the control inputs HM, T, R and G have no galvanic separation to the measuring circuit L(+) and L(-) and are electrically connected together, therefore they have to be controlled by volt free contacts or bridge. These contacts or bridges must provide a sufficient separation depending on the mains voltage on L(+)-L(-).
- No external potentials may be connected to control terminals HM, T and R. The associated reference potential is G (identical with PE), and the connection of the terminals is made via bridges to G.



Attention!

- Before checking insulation and voltage, disconnect the monitoring device from the power source!
- Only one insulation monitor may be active in a network to be monitored, since the devices would otherwise influence each other. When coupling several networks or incoming feed sections, where each of them is equipped with its own insulation monitor, all of them must be deactivated except for one insulation monitor. Such deactivation can be beneficially handled via the HM-G control terminals with the CM-IWM.11.
- Device terminals PE and KE must always be connected via separate lines to different terminal points of the protective-conductor system.
- The device must not be operated without KE/PE connection!
- The measuring circuit should not be connected via longer parallel guided wires, as this may interfere with the broken wire detection. Also large capacities between L(+) and L(-) have to be avoided.

Important!

- The measuring circuit can be connected with its terminals L(+) and L(-) both to the DC and also AC side of a mixed network; it is done most practically where the primary incoming power supply takes place. Selector switch "t_v / U_N" should be set accordingly.
For photovoltaic systems and hybrid vehicles, the measuring circuit of the CM-IWM is connected on the DC side.
- If a monitored AC system includes galvanically connected DC circuits (e.g. via a rectifier), an insulation failure on the DC side can only be detected correctly, when a current of min 10 mA can flow via the semiconductor connections.
- If a monitored DC system includes galvanically connected AC circuits (e.g. via an inverter), an insulation failure on the AC side can only be detected correctly, when a current of min 10 mA can flow via the semiconductor connections.
- The measuring circuit is designed for large leakage capacitances up to 3000 µF. The selection switch "CE/µF" must be set accordingly. Measurement of the insulation resistances is not falsified by this; however, longer periods are required for the measuring phases than with small capacitances. If the maximum approximate leakage capacitance is known, the selector switch "CE/µF" can possibly be set to smaller values, which reduces the response time further.
- For the main measuring circuit, the nominal voltage range for DC is specified with 1000 V; however, absolute values up to max. DC 1500 V are permissible.
- This is a Class A product. In a domestic environment this product may cause radio interference in which case the user may be required to take adequate measures.

Technical data

Data at $T_a = 25\text{ °C}$ and rated values, unless otherwise indicated

Input circuit

Rated control supply voltage U_S	24 V DC
Allowed voltage range of the supervised network	20-30 V DC
Typical power consumption	max. 5 W

Measuring circuit

		L(+) / L(-) to PE / KE	
Nominal voltage U_N		0-1000 V AC/DC	
Allowed voltage range of the supervised network		0-1100 V AC / 0-1500 V DC	
Permanent admissible extraneous DC voltage U_{fg}	max.	1500 V DC	
Frequency range		DC or 16-1000 Hz	
Max. system leakage capacitance C_e		3000 μF	
Internal resistance (AC/DC)		> 280 k Ω	
Measuring voltage		approx. $\pm 95\text{ V}$	
Max. measured current ($R_E = 0$)		< 0.35 mA	
Response values R_E each adjustable via rotary switches	Pre-warning ("VW")	Warning ("AL")	
		20 k Ω	1 k Ω
		30 k Ω	3 k Ω
		50 k Ω	10 k Ω
		70 k Ω	20 k Ω
		100 k Ω	30 k Ω
		150 k Ω	50 k Ω
		250 k Ω	70 k Ω
		500 k Ω	100 k Ω
		1000 k Ω	150 k Ω
		2000 k Ω	250 k Ω
Response inaccuracy	IEC 61557-8	$\pm 15\% + 1.5\text{ k}\Omega$	
Response value hysteresis	at range 10 k Ω ... 700 k Ω	approx. 25 %	
	out of range:	approx. 40 % + 0.5 k Ω	
ON delay	at $C_E = 1\text{ }\mu\text{F}$ R_E of ∞ to 0.5 * response value	< 10 s	

Technical data

Control input

	between HM, T, R and G
Current flow	approx. 3 mA
No-load voltage to ground	approx. 12 V
Permissible wire length	< 50 m
Min. activation time	0.5 s

Output

Contacts	2 x 1 c/o contacts for VW and AL
Thermal current I_{th}	4 A
Switching capacity to AC-15	n/o contact 3 A / AC 230 V acc. to IEC/EN 60947-5-1 n/c contact 1 A / AC 230 V acc. to IEC/EN 60947-5-1
Electrical life	at 8 A, AC 250 V 1 x 10 ⁴ switching cycles
Short circuit strength max. fuse rating	4 A gL acc. to IEC/EN 60947-5-1
Mechanical life	10 x 10 ⁶ switching cycles

General Data

Operating mode	Continuous operation
Temperature range	operation - 25 ... + 60 °C (device mounted away from heat generation components) -25 ... +45 °C (device mounted without distance to other devices) storage - 40 ... + 70 °C
Relative air humidity	93 % at 40 °C
Atmospheric pressure	860-1600 mbar (86-106 kPa)
Altitude	IEC/EN 60664-1 < 4000 m
Clearance and creepage distances	
Rated impulse voltage / pollution degree	IEC/EN 60664-1
Measuring circuit L(+) / L(-) to	auxiliary voltage DC and relay contacts VW, AL 8 kV / 2 auxiliary voltage DC to relay contacts VW, AL 8 kV / 2 relay contacts VW to relay contact AL 4 kV / 2
Insulation test voltage, routine test	AC 5 kV; 1 s AC 2.5 kV; 1 s

Technical data

EMC		
Electrostatic discharge (ESD)	IEC/EN 61000-4-2	8 kV (air)
HF irradiation	IEC/EN 61000-4-3	80 MHz-2.7 GHz: 10 V/m
Fast transients	IEC/EN 61000-4-4	4 kV
Surge voltages	IEC/EN 61000-4-5	between A1 - A2: 1 kV L(+) - L(-): 2 kV A1, A2 - PE: 4 kV L(+), L(-) - PE: 4 kV control line: 0.5 kV control line and earth: 1 kV
HF-wire guided	IEC/EN 61000-4-6	10 V
Interference suppression	EN 55011	Limit value class A When connected to a low voltage public system (Class B, EN 55011) radio interference can be generated. To avoid this, appropriate measures have to be taken
Degree of protection		
Housing	IEC/EN 60529	IP 40
Terminals	IEC/EN 60529	IP 20
Housing		Thermoplastic with V0 behaviour according to UL subject 94
Vibration resistance	IEC/EN 60068-2-6	10-55 Hz: 0.35 mm 2-13.2 Hz: ± 1 mm 13.2-100 Hz: ± 7 g
Shock resistance	IEC/EN 60068-2-27	10 g / 11 ms, 3 pulses
Climate resistance	IEC/EN 60068-1	25 / 060 / 04
Terminal designation		EN 50005
Connecting capacity		1 x 4 mm ² solid 1 x 2.5 mm ² stranded ferruled (isolated) 2 x 1.5 mm ² stranded ferruled (isolated) DIN 46228-1/-2/-3-4 2 x 2.5 mm ² stranded ferruled (isolated) DIN 46228-1/-2/-3
Stripping length		8 mm
Tightening torque		0.8 Nm
Wire fixing		Plus-minus terminal screws M3,5 terminal with wire protection
Mounting	IEC/EN 60715	DIN rail
Weight		approx. 500 g
Dimensions	Width x height x depth	90 x 90 x 121 mm

Technical data UL

Measuring circuit L(+) / L(-) to PE / KE		
Allowed voltage range of the supervised network	AC/DC	max. 600 V
Switching capacity		Pilot duty B300, C300, R300 4 A 250 V AC, resistive 4 A 30 V DC, resistive
Wire connection		Min. 60 °C copper conductors only Torque 0.8 Nm
Test specification		ANSI/UL 60947-1, 5 th Edition ANSI/UL 60947-5-1, 3 rd Edition CAN/CSA-C22.2 No. 60947-1-13, 2 nd Edition CAN/CSA-C22.2 No. 60947-5-1-14, 1 st Edition

Measuring times

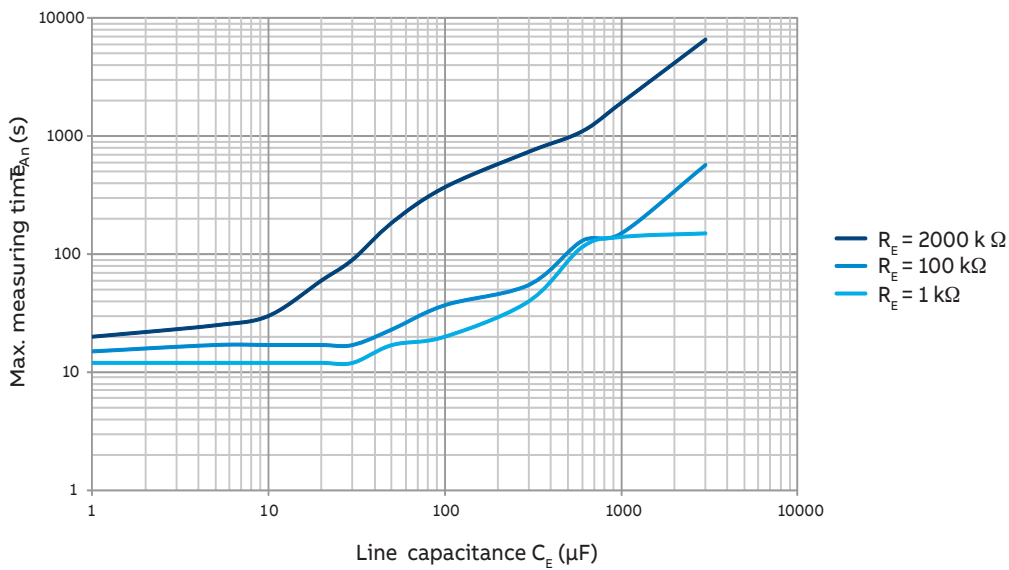

2CDC 252 014 F0016

Max. measuring times in response to the line capacitance

