

Specific systems protection

ESP RF Series



Combined Category D, C, B tested surge protective device (SPD) (to BS EN 61643) suitable for RF systems using coaxial cables at frequencies between DC and up to 3.5 GHz (or 7 GHz for HF range) and where DC power is present. Suitable for RF systems with power up to 780 W. For use at boundaries up to LPZ 0 to protect against flashover (typically the service entrance location) through to LPZ 2 to protect equipment.

FULL MODE Bonding + Equipment Protection	LPZ 0 → 2	SIGNAL/ TELECOM TEST CAT D + C + B
HIGH BANDWIDTH		

Features & benefits

- Very low let-through voltage (enhanced protection to IEC/BS EN 62305) between all lines - Full Mode protection
- Full Mode design capable of handling partial lightning currents as well as allowing continual operation of protected equipment
- Repeated protection in lightning intense environments
- Wide bandwidth means a single product is suitable for a range of applications

- Very low attenuation and near unity VSWR over a wide range of frequencies ensure the protectors do not impair system performance
- Available with N, 7/16 DIN, SMA, TNC and BNC connectors
- Easily mounted and earthed via bulkhead mounting, or via mounting brackets
- Bulkhead-female to male connections for simple installation
- Indoor or outdoor use up to IP66

Application

Use on coaxial cables to protect RF transmitter and receiver systems, including electronics located at the antenna or dish. Typical examples include cell sites, military communications, satellite earth stations, pager systems and emergency services communications systems.

Installation

In a building, connect in series with the coaxial cable near where it enters or leaves the structure, or close to the equipment being protected. This should be as close as possible to the system's earth star point (to enable a good connection to earth). On a mast, connect in series with the coaxial cable near the antenna/dish being protected. Install in a radio communications room, an existing cabinet or a suitable enclosure.

Accessories

Angled brackets

- ESP RF/BK-N** (7TCA085450R0078)
- ESP RF/BK-DIN** (7TCA08 5450R0077)
- ESP RF/BK-SMA** (7TCA085450R0080)
- ESP RF/BK-BNC/TNC** (7TCA085450R0079)

Replacement GDT capsules

- ESP RF/GDT-500V** (7TCA085450R0081)
- ESP RF/GDT-250V/HF** (7TCA085450R0082)
- ESP RF/GDT-500V/HF** (7TCA085450R0083)

ESP RF/N with N bulkhead female/ N male connectors installed in series

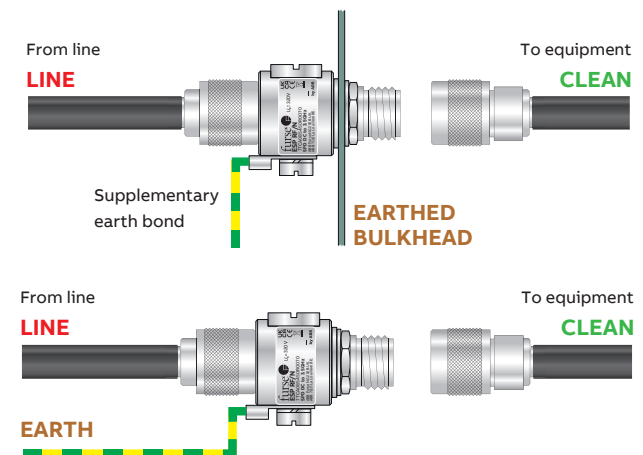

NOTE: These protectors are based on a continuous transmission line with a GDT connected between this line and screen/earth, and are suited for applications where DC is required to pass to the equipment. ESP CCTV/B and ESP CCTV/T are suitable for use on coaxial (or twisted pair) CCTV lines. For coaxial CATV lines, use the ESP CATV/F.

ESP RF Series - Technical specification

Electrical specification	ESP RF/N	ESP RF/DIN	ESP RF/BNC	ESP RF/TNC	ESP RF/SMA
ABB order code	7TCA085450R0070	7TCA085450R0071	7TCA085450R0072	7TCA085450R0073	7TCA085450R0068
Gas Discharge Tube voltage	500 V				
Maximum working voltage U _c (Peak)	320 V				
Characteristic impedance	50 Ω				
Capacitance (@ 1 MHz)	< 5 pF				
Bandwidth	DC-3.5 GHz				
Voltage standing wave ratio (VSWR)	≤ 1.2				
Insertion loss over bandwidth	≤ 0.2 dB				
Maximum power ⁽¹⁾	780 W				
Transient specification	ESP RF/N	ESP RF/DIN	ESP RF/BNC	ESP RF/TNC	ESP RF/SMA
Let-through voltage (all conductors)⁽²⁾ U_p					
C2 test 4 kV 1.2/50 μs, 2 kA 8/20 μs to BS EN/EN/IEC 61643-21	< 1.5 kV				
C1 test 2 kV 1.2/50 μs, 1 kA 8/20 μs to BS EN/EN/IEC 61643-21	< 1.45 kV				
B2 test 4 kV 10/700 μs to BS EN/EN/IEC 61643-21	< 1.5 kV				
C3 test 1kV/μs, 100 A 10/1000 μs	< 1.2 kV				
Maximum surge current⁽³⁾					
D1 test 10/350 μs to BS EN/EN/IEC 61643-21	1 kA				
8/20 μs to ITU-T K.45:2003, IEEE C62.41.2:2002	20 kA				
Mechanical specification	ESP RF/N	ESP RF/DIN	ESP RF/BNC	ESP RF/TNC	ESP RF/SMA
Temperature range	-40 to +80 °C				
Connection type, input LINE side	N bulkhead female	7/16 DIN bulkhead female	BNC bulkhead female	TNC bulkhead female	SMA bulkhead female
Connection type, output CLEAN side	N male	7/16 DIN male	BNC male	TNC male	SMA male
Case Material	Brass body, alloy plated. Bronze connections, silver plated				
Weight: – Unit	120 g	190 g	90 g	130 g	130 g
– Packaged	140 g	210 g	110 g	150 g	150 g
Degree of protection (IEC 60529)	IP66				
Dimensions	See diagram below				

⁽¹⁾ Power levels have been de-rated to allow for real life 'worst case' conditions, calculated with VSWR as 2:1.
⁽²⁾ Response time < 10ns.
⁽³⁾ The installation and connections external to the protector may limit the capability of the protector

Mounting hole dimensions

ESP RF/BNC

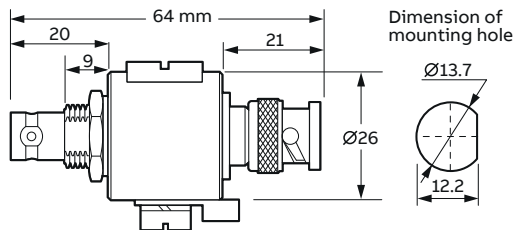

ESP RF/N

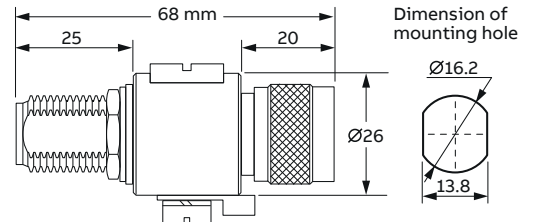

ESP RF/SMA

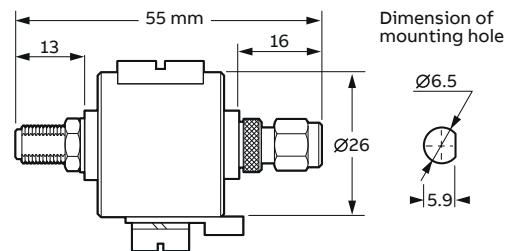

ESP RF/DIN

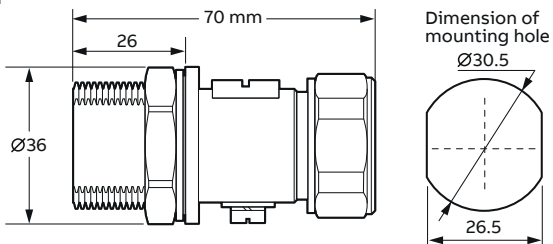

ESP RF/TNC



ABB Limited
 Furse
 Wilford Road
 Nottingham
 NG2 1EB UK
 Tel: +44 (0) 115 964 3700

We reserve the right to make technical changes or modify the contents of this document without prior notice. With regard to purchase orders, the agreed particulars shall prevail. ABB AG does not accept any responsibility whatsoever for potential errors or possible lack of information in this document.

We reserve all rights in this document and in the subject matter and illustrations contained therein. Any reproduction, disclosure to third parties or utilisation of its contents – in whole or in parts – is forbidden without prior written consent of ABB AG. Copyright © 2022 ABB. All rights reserved

ESP RF Series - Technical specification

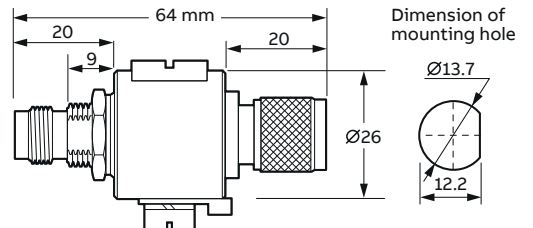
Electrical specification	ESP RF/N-HF	ESP RF/TNC-HF	ESP RF/SMA-HF
ABB order code	7TCA085450R0074	7TCA085450R0076	7TCA085450R0075
Gas Discharge Tube voltage	500 V	250 V	250 V
Maximum working voltage U _c (Peak)	320 V	160 V	160 V
Characteristic impedance	50 Ω		
Capacitance (@ 1 MHz)	< 5 pF		
Bandwidth	DC-7.0GHz		
Voltage standing wave ratio (VSWR)	≤ 1.2		
Insertion loss over bandwidth	≤ 0.2 dB		
Maximum power ⁽¹⁾	780 W	190 W	190 W
Transient specification	ESP RF/N-HF	ESP RF/TNC-HF	ESP RF/SMA-HF
Let-through voltage (all conductors)⁽²⁾ Up			
C2 test 4 kV 1.2/50 μs, 2 kA 8/20 μs to BS EN/EN/IEC 61643-21	< 1.5 kV	< 1.2 kV	< 1.2 kV
C1 test 2 kV 1.2/50 μs, 1 kA 8/20 μs to BS EN/EN/IEC 61643-21	< 1.45 kV	< 1.1 kV	< 1.1 kV
B2 test 4 kV 10/700 μs to BS EN/EN/IEC 61643-21	< 1.5 kV	< 1 kV	< 1 kV
C3 test 1kV/μs, 100 A 10/1000 μs	< 1.5 kV	< 1.2 kV	< 1.2 kV
Maximum surge current⁽³⁾			
D1 test 10/350 μs to BS EN/EN/IEC 61643-21	1 kA		
8/20 μs to ITU-T K.45:2003, IEEE C62.41.2:2002	20 kA		
Mechanical specification	ESP RF/N-HF	ESP RF/TNC-HF	ESP RF/SMA-HF
Temperature range	-40 to +80 °C		
Connection type, input LINE side	N bulkhead female	TNC bulkhead female	SMA bulkhead female
Connection type, output CLEAN side	N male	TNC male	SMA male
Case Material	Brass body, alloy plated. Bronze connections, silver plated		
Weight: – Unit	120 g	130 g	130 g
– Packaged	140 g	150 g	150 g
Degree of protection (IEC 60529)	IP66		
Dimensions	See diagram below		

⁽¹⁾ Power levels have been de-rated to allow for real life 'worst case' conditions, calculated with VSWR as 2:1.
⁽²⁾ Response time < 10ns.
⁽³⁾ The installation and connections external to the protector may limit the capability of the protector

Mounting hole dimensions

ESP RF/BK-BNC/TNC

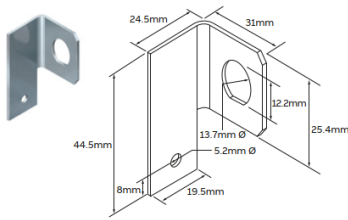

ESP RF/BK-N

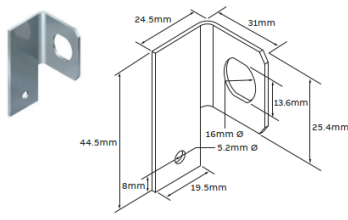

ESP RF/BK-DIN

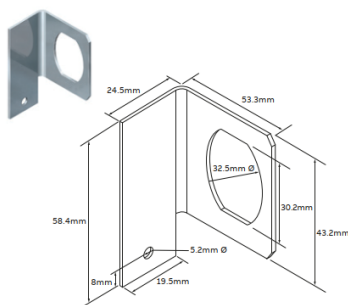

ESP RF/BK-SMA

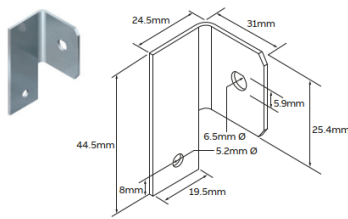

ESP RF/N-HF

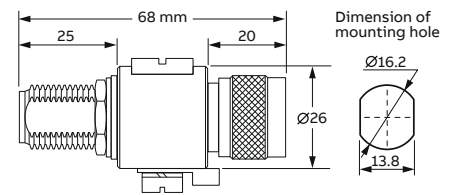

ESP RF/SMA-HF

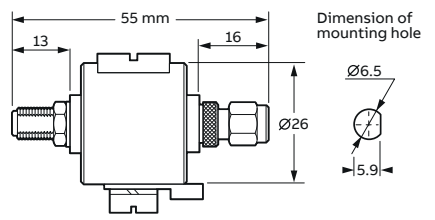

ESP RF/TNC-HF

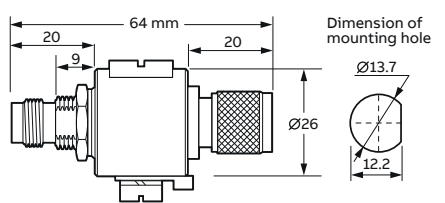

ABB Limited
 Furse
 Wilford Road
 Nottingham
 NG2 1EB UK
 Tel: +44 (0) 115 964 3700

www.furse.com

We reserve the right to make technical changes or modify the contents of this document without prior notice. With regard to purchase orders, the agreed particulars shall prevail. ABB AG does not accept any responsibility whatsoever for potential errors or possible lack of information in this document.

We reserve all rights in this document and in the subject matter and illustrations contained therein. Any reproduction, disclosure to third parties or utilisation of its contents – in whole or in parts – is forbidden without prior written consent of ABB AG. Copyright © 2022 ABB. All rights reserved.