

## Ceiling Switches

### Standards and approvals

3164WHI fully complies with the 16th Edition Wiring Regulations (BS 7671: 2008 with respect to safety isolation for maintenance purpose. Conforms to BS EN 60669-1: 1999

3190WHI, 3191WHI, 3192WHI, 3131WHI, 2051WHI, 2056WHI, conform to BS EN 60669-1: 1999

3151WHI conforms to BS EN 60669-1: 1999

### Technical specification

#### Electrical

Voltage rating:  
250V a.c.

Maximum rating:  
See range details

Note: Switches do not have to be derated when used with resistive or fluorescent loads

Terminal capacity:

3131, 3190, 3191, 3192:

4 x 1.0mm<sup>2</sup>  
3 x 1.5mm<sup>2</sup>

3151,

4 x 2.5mm<sup>2</sup>  
2 x 4.0mm<sup>2</sup>  
1 x 6mm<sup>2</sup>

3164,

4 x 4mm<sup>2</sup>  
3 x 6mm<sup>2</sup>  
1 x 10mm<sup>2</sup>  
1 x 16mm<sup>2</sup>

2051/2056, Earth Terminal

6 x 1mm<sup>2</sup>  
4 x 1.5mm<sup>2</sup>  
2 x 2.5mm<sup>2</sup>  
1 x 4mm<sup>2</sup>  
1 x 6mm<sup>2</sup>

#### Physical

Ambient operating temperature:  
-5°C to +40°C  
(the average value over 24 hrs not exceeding 25°C)

IP rating:  
IP3X

Max. installation altitude:  
2000 metres



### Description

A range of 6 and 16 amp ceiling switch options plus a 50 amp DP flush mounted ceiling switch.

### Features

- Mounting blocks have an earth terminal rivetted into their bases
- 3190RCWHI has a retractive (momentary) switch action and can be wired as either pull to make or pull to break
- 3190RCWHI has a red pull cord
- Ceiling switches with standard white cords are 1.5m minimum length, and with standard red cords are 2m minimum length
- Ceiling switches with white cords **and bangles** are 2m minimum length, and with red cords **and bangles** are 3m minimum length
- 3164WHI is fitted with mechanical OFF indicator
- 3164 has a full 3 mm contact gap when off
- 3164 may be surface mounted

### Dimensions (mm)

3191WHI/3192WHI

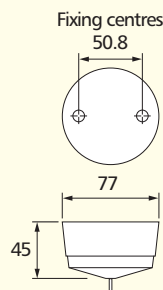

3190RCWHI

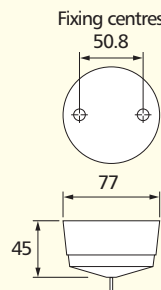

3131WHI

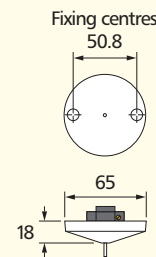

3164WHI

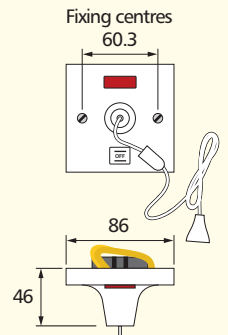

3151WHI

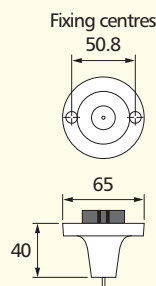

2051WHI

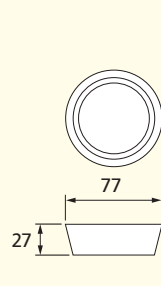

2056WHI

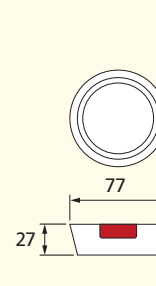

### Installation

MK ceiling accessories are safe for use in all normal lighting applications. Do not mount them where they may be subjected to excessive moisture or dampness.

### Wiring

Products must be installed in accordance with BS 7671: 2008.

For a full range of corresponding products, see pages 67-70 in the product selector.

## Ceiling Roses and Pendants

### Standards and approvals

Heat resistant lampholders comply with BS EN 61184: 1997 T2

All ShockGuard lampholders comply with BS 7895: 1997 and BS EN 61184: 1997 T2

Ceiling roses comply with BS 67: 1987

Pendant sets are supplied with heat resisting PVC insulated and sheathed flexible 0.75 two core circular cable complying with BS 6500: 2000 (Table 29)

### Technical specification

#### Electrical

Lampholders and batten lampholders

Voltage rating:  
250V a.c.

Maximum rating:  
150 watts

Terminal capacity:  
Live, neutral & earth  
3 x 1.0mm<sup>2</sup>  
2 x 1.5mm<sup>2</sup>

Ceiling roses & base of pre-wired batten lampholders

Voltage rating:  
250V a.c.

Maximum rating:  
6 amps

Terminal capacity:  
Live, neutral & earth  
4 x 1.0mm<sup>2</sup>  
3 x 1.5mm<sup>2</sup>  
1 x 2.5mm<sup>2</sup>

#### Physical

Ambient operating temperature:  
-5°C to +40°C

IP rating:  
IP4X

Max. installation altitude:  
2000 metres

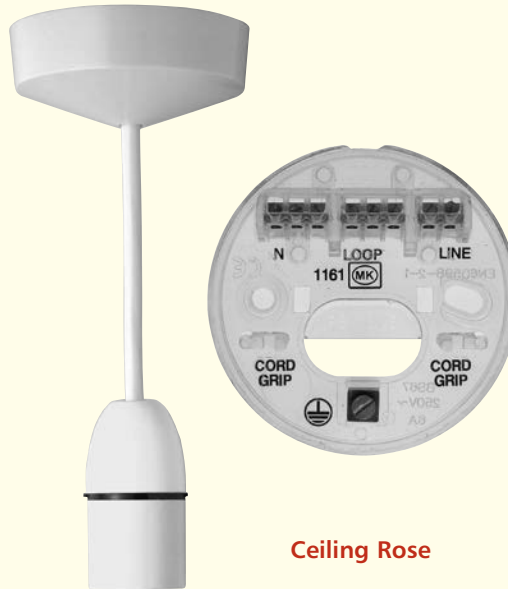

Ceiling Rose

### Dimensions (mm)

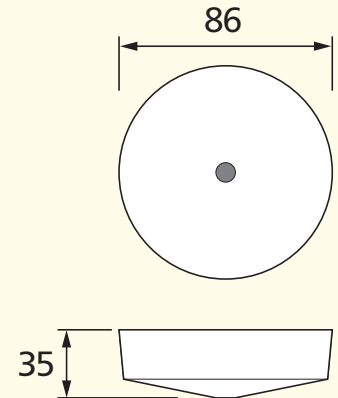

### Description

The range includes ShockGuard™ SG type lampholders, pendant sets, batten lampholders and ceiling roses.

### Features

#### ShockGuard™

- Automatically shields the contacts as soon as the lamp is removed
- The contacts remain shielded until a new lamp is slotted into place
- While there is no lamp in place there is no danger of electrocution

#### Ceiling roses

- Clear base and pre-cut aperture for ease of installation
- Clear markings
- Terminal layout allows cables to be cut to even length
- Earth terminal point used for easier cable access
- Halo available to give professional finish on damaged ceilings (for use with ceiling roses and pendant sets only)

## Lampholders and Shockguard type Lampholders

### Dimensions (mm)

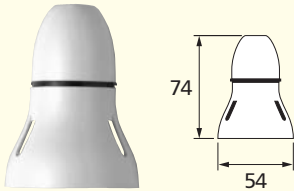

**Standard Lampholder with protective skirt**

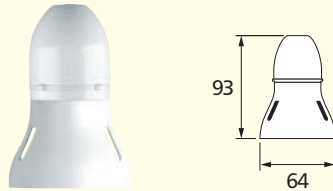

**SG Type Lampholder with protective skirt**

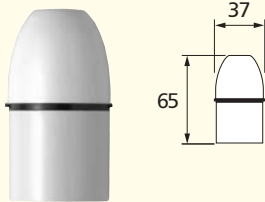

**Standard Lampholder**

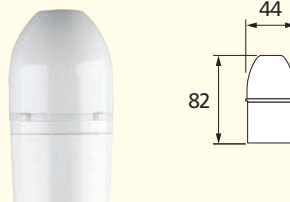

**SG Type Lampholder**

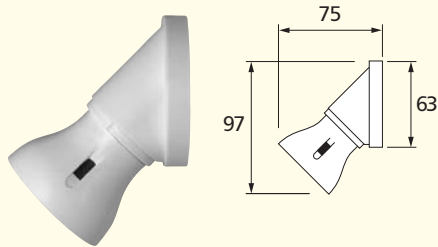

**Standard Angled Batten Lampholder**

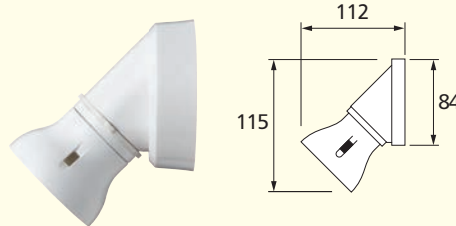

**SG Type Angled Batten Lampholder**

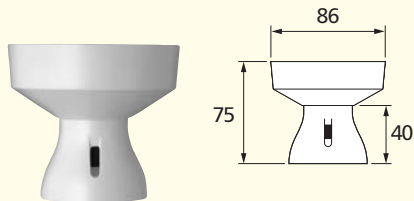

**Standard Batten Lampholder**

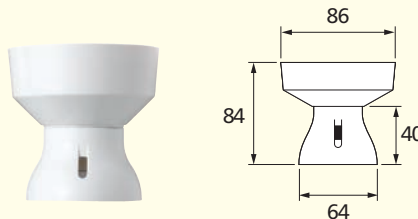

**SG Type Batten Lampholder**

### Heat Resistance

Two levels of heat resistance are nominated for lampholders but at different maximum working temperatures and the products must be identified by a different marking code.

Heat resistance	Max working temp
T2	Lamp cap temp 210°C marked BS 7895 and BSEN 61184 T2

### Lamp wattage rating

All MK lampholders comply with category T2 BS EN 61184. It is important to ensure that the wattage rating of the lamp used is not higher than that for which the particular shade or luminaire is designed. The maximum rating in watts is marked on all shades and luminaires that comply with the requirements of BS 4533: Part 101.

### Weight of fittings

Ceiling roses and pendant sets are suitable for fittings of up to 3 kg. Heavier fittings must be installed using independent support, e.g. ceiling hook.

### Angled batten lampholders

Can be mounted direct to the wall. The surface mounting patress (1179 WHI) may be used if more wiring space is required.

### Straight batten lampholders

Can be screwed direct to the ceiling but it must be ensured that it is fastened to a wooden joist. Integral Ceiling Rose included.

### Ceiling roses and pendant sets

Flush mounting to circular conduit boxes in accordance with BS 4568: Part 2.

### Installation

MK ceiling accessories are safe for use in all normal lighting applications. Do not mount them where they may be subjected to excessive moisture or dampness.

### Wiring

Products must be installed in accordance with BS 7671: 2008.