



CONNECT AND PROTECT

Earthing

White Paper



HOFFMAN



Table of contents

Introduction	4
Electrical protection of people	6
nVent HOFFMAN accessories for earthing connections	8
Standard solutions	10
Floor standing enclosures	10
Wall mounted enclosures	14
Terminal boxes	16
Other Solutions	18
EMC enclosures - Floor standing	18
EMC enclosures - Wall mounted	20
Connection to the frame through ECFP	23
nVent HOFFMAN earthing test	24
Floor standing enclosures	26
Wall mounted enclosures	30
Method of calculating the cross-sectional area of protective conductors	31

Introduction

Safety is a primary goal within the electrical industry, therefore nVent HOFFMAN is constantly looking for new solutions to offer to our customers.

In an electrical circuit, there is what is known as a hot wire, which supplies the power, and a neutral wire, which carries that current back. An additional 'grounding wire' can be attached to outlets and other electrical devices and also securely connected to the ground at the breaker box. This ground wire is an additional path for electrical current to return safely to the ground without danger to anyone in the event of a short circuit. If a short circuit did occur, the current would flow through the ground wire, causing a blown fuse or tripped circuit breaker – an outcome much more preferable than the fatal shock that could result if the current was not grounded.

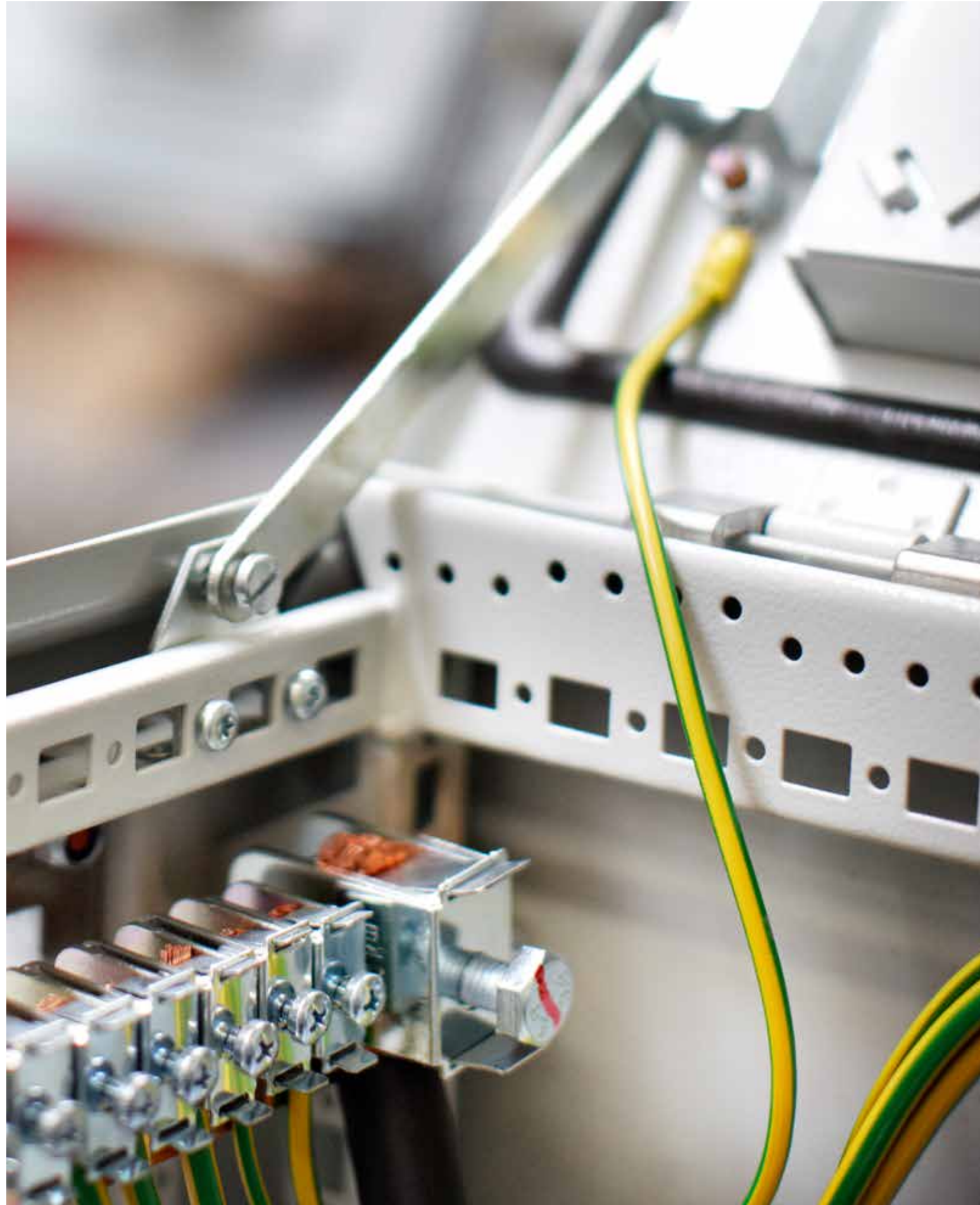

The following is a look at some of the main reasons why grounding electrical currents is so important:

Protection against electrical overload

One of the most important reasons for grounding electrical currents is that it protects equipment, machinery and people. If lightning was to strike or the power was to surge at your place for whatever reason, this produces dangerously high voltages of electricity in your system. If your electrical system is grounded, all of that excess electricity will go into the earth – rather than frying everything connected to your system.

Helps direct electricity

Having your electrical system grounded means you will be making it easy for power to be directed straight to wherever you need it, allowing electrical currents to safely and efficiently travel throughout your electrical system.

Stabilises voltage levels

A grounded electrical system also makes it easier for the right amount of power to be distributed to all the right places, which can play a huge role in helping to ensure circuits aren't overloaded and blown. The earth provides a common reference point for the many voltage sources in an electrical system.

Earth is the best conductor

One of the reasons why grounding helps to keep you safe is because the earth is such a great conductor, and because excess electricity will always take the path of least resistance. By grounding your electrical system, you are giving it somewhere to go other than into you – possibly saving your life.

Prevents damage, injury and death

Without a properly grounded electrical system, you are risking any appliances you have connected to your system being fried beyond repair. In the worst-case scenario, an overload of power can even cause a fire to start, risking not just extensive property and data loss but physical injury as well.

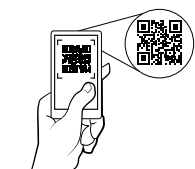

Electrical protection of people

Within electrical protection, protection of people is the most important goal for nVent HOFFMAN.

The human body conducts electricity, therefore, if any part of the body receives an electric shock, the electricity will flow through the tissues with little obstruction. Electric shocks can result in irreversible effects or even death, depending on the intensity of the shock and time of exposure.

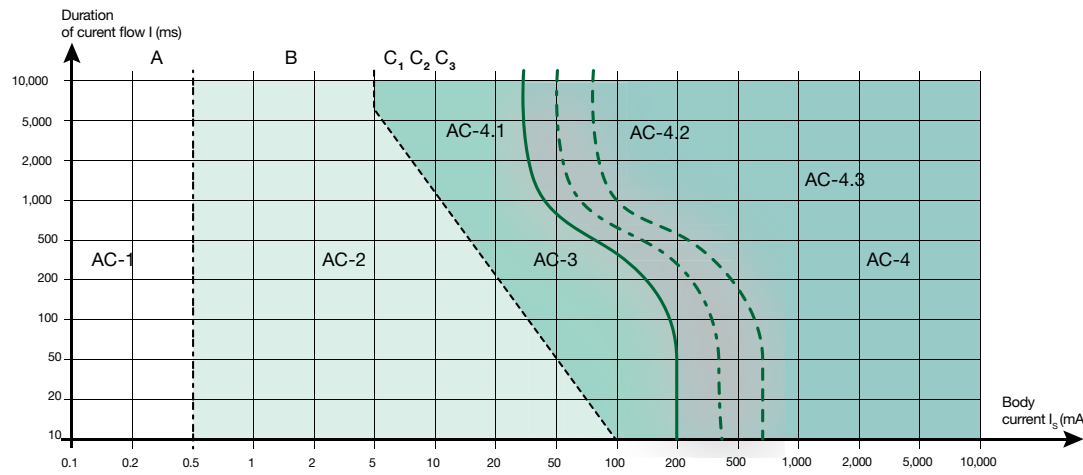

AC - 1 zone: Imperceptible
 AC - 2 zone: Perceptible
 AC - 3 zone: Reversible effects: muscular contraction
 AC - 4 zone: Possibility of irreversible effects

AC - 4-1 zone: Up to 5% probability of heart fibrillation
 AC - 4-2 zone: Up to 50% probability of heart fibrillation
 AC - 4-3 zone: More than 50% probability of heart fibrillation

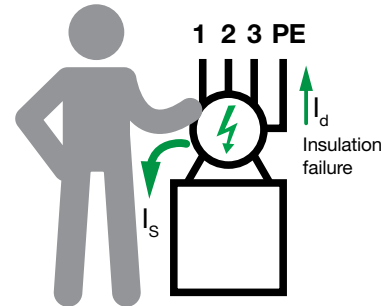
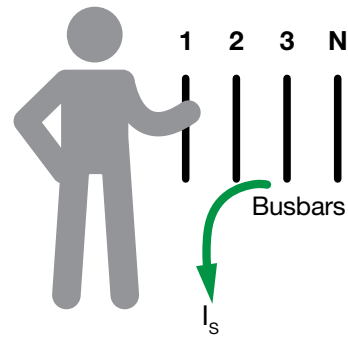

Electric shocks can be caused by:

Direct Contact

A direct contact refers to a person coming into contact with a conductor which is live in normal circumstances.

Indirect Contact

An indirect contact refers to a person coming into contact with an exposed conductive part which is not normally alive, but has become alive accidentally (due to insulation failure or some other cause).

The fault current raises the exposed conductive part to a voltage liable to be hazardous, which could be the origin of a touch current resulting from a person coming into contact with this exposed conductive part.

To avoid indirect contact, earthing has an important role working together with an automatic disconnecting device. Following examples explain different situations where there is an indirect contact, and how some measures may protect people.

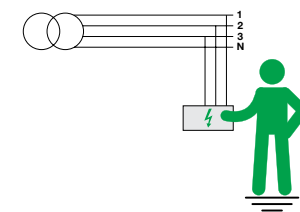

01 No insulation fault
 No earthing
 No disconnecting device

No damage

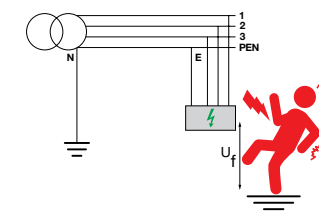

02 Insulation fault
 Earthing
 No disconnecting device

Person gets shocked

Current goes through the protective circuit and person.

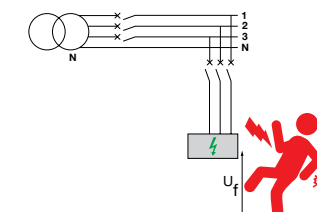

03 Insulation fault
 No earthing
 Disconnecting device

Person gets shocked

Disconnecting device will cut the supply.

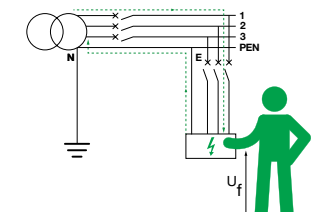

04 Insulation fault
 Earthing
 Disconnecting device

No damage

Disconnecting device will cut the supply. Current goes through the protective circuit.

Relevant standards

The following standards should be taken into account regarding earthing:

- EN 62208:
Empty enclosures for low-voltage switchgear and control gear assemblies. General requirements.
- EN 61439-1:
Low-voltage switchgear and control gear assemblies
Part 1: General rules.
- EN 60204-1:
Safety of machinery – Electrical equipment of machines
Part 1: General requirements.

nVent HOFFMAN solutions for earthing

Introduction

nVent HOFFMAN enclosures have been designed to ensure earth continuity protection against the consequences of faults within the assembly, so all exposed conductive parts are interconnected together and to the protective conductor of the supply or via an earthing conductor to the earthing arrangement.

These interconnections may be carried out either by metal screwed connections, welding or other conductive connections, or by a separate protective conductor (nVent HOFFMAN earthing accessories).

Additionally, nVent HOFFMAN has taken into account the following considerations:

- When a part of the assembly is removed, the protective circuits (earth continuity) for the remainder of the assembly shall not be interrupted.
- For lids, doors, cover plates and the like, the usual metal screwed connections and metal hinges are considered sufficient to ensure continuity, provided that no electrical equipment exceeding limits of extra low voltage (ELV) is attached to them.
- Certain exposed conductive parts of an assembly that do not constitute a danger need not be connected to a protective conductor. This is either because they cannot be touched on large surfaces or grasped with the hand, or because they are of small size (50 mm x 50 mm), or so located as to exclude any contact with live parts.

If equipment with a voltage exceeding the limits of extra-low voltage is attached to lids, doors, or cover plates additional measures shall be taken to ensure earth continuity, therefore nVent HOFFMAN accessories shall be mounted as protective conductors. Moreover, when exposed conductive parts of a device cannot be connected to the protective circuit by the fixing means, nVent HOFFMAN accessories shall be mounting as well, providing a connection to the protective circuit.

To sum up, all the exposed conductive parts of the nVent HOFFMAN enclosures are effectively connected to the earthing terminal of the protective circuit with a maximum resistance of 0.1 Ω . To ensure that these earthing points will give you the desired protection, nVent HOFFMAN has verified their products by testing at the Independent institute TNO in The Netherlands.

nVent HOFFMAN accessories for earthing connections

ECFP

This accessory provides a much more resistant earthing protection than regular earthing connections. It can be especially useful when many earthing connections are needed to the enclosure frame

ECFA

Cable to be used to connect the different parts of the protective earthing circuit. It is green and yellow according to EN 61439-1 and EN 60240-1. It is made of copper and its section is 6 mm².

ECF

Floor-standing enclosures frequently need extra earthing connections from enclosure parts (profiles, side panels, roof, other electrical equipment, etc.) or other material to the enclosure frame. The ECF kit is the perfect solution in these cases.

ECFE

Especially recommended for EMC applications for its increased conduction capacity. Made of tinned copper.

ECP

Used to install earthing connections to mounting plates, profiles, bottom plates or other parts with similar earthing facilities. Available in M6 and M8 configurations.

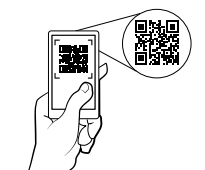

Standard solutions

All nVent HOFFMAN enclosures are manufactured to provide earth continuity protection:

- Without using any separate protective conductor or accessory.
- By effective connection of earthing accessories (see previous section).

The following sections explain in detail how to carry out both depending on the product range.



Floor standing range **Combinable enclosures** (MCS/MCD)

Manufactured features

Earthing continuity protection through accessories

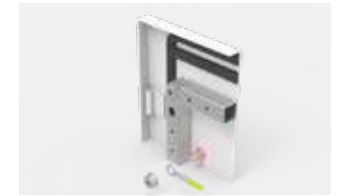

Door
Connection with cable (ECFA or ECFE) to the frame using ECF.

Side Panel
Connection with cable (ECFA or ECFE) to the frame using ECF.

Roof
Connection with cable (ECFA or ECFE) to the frame using ECF.

Rear Panel
Connection with cable (ECFA or ECFE) to the frame using ECF.

Mounting Plate
Connection with cable (ECFA or ECFE) to the frame using ECF.

Mounting Plate
Connection with cable (ECFA or ECFE) to the rear panel using ECF.

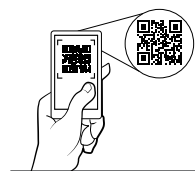

Door

Earthing studs in door in order to use earthing accessories.



Side Panel

Electrically connected to the frame using brackets which scratch the paint when screws are tightened.

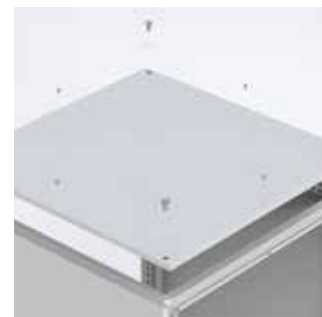

Roof

Electrically connected thanks to scratching the paint when screws are tightened.



Rear Panel

Electrically connected thanks to scratching the paint when screws are tightened.



Bottom Plate

Electrically connected thanks to scratching the paint when screws are tightened.



Mounting Plate

4 holes for earthing.

Standard solutions



Floor standing range
Compact enclosures
 (MKS/MKD)

Manufactured features

Earthing continuity protection through accessories

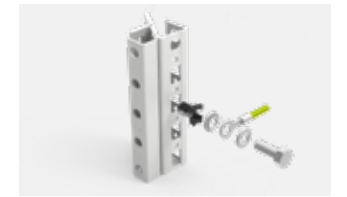

Door
 Connection with cable (ECFA or ECFE) to the frame using ECF.

Roof
 Connection with cable (ECFA or ECFE) to the frame using ECF.

Rear Panel
 Connection with cable (ECFA or ECFE) to the frame using ECF.

Mounting Plate
 Connection with cable (ECFA or ECFE) to the frame using ECF.

Mounting Plate
 Connection with cable (ECFA or ECFE) to the rear panel using ECF.

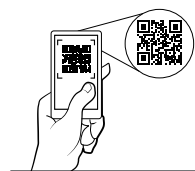

Door

Earthing studs in door in order to use earthing accessories.

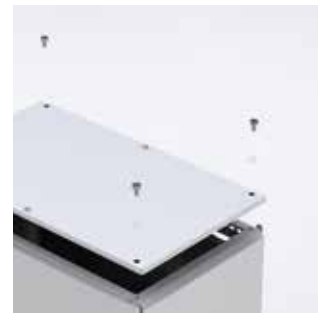

Roof

Electrically connected thanks to scratching the paint when screws are tightened.



Rear Panel

Electrically connected thanks to scratching the paint when screws are tightened.



Bottom Plate

Electrically connected thanks to scratching the paint when screws are tightened.



Mounting Plate

4 holes for earthing.

Standard solutions



Wall mounted enclosures (MAS/MAD)

Earthing continuity protection through accessories

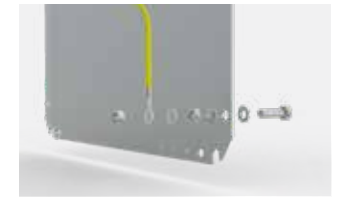

Door
Connection with cable (ECFA or ECFE) to the frame using ECF.

Mounting Plate
Connection with cable (ECFA or ECFE) to the frame using ECF.

Mounting Plate
Connection with cable (ECFA or ECFE) to the rear panel using ECP.

Manufactured features

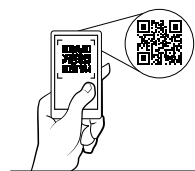

Door

Earthing studs in door in order to use earthing accessories.

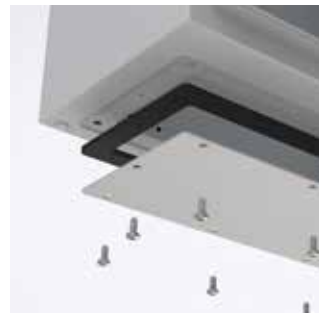

Gland Plate

Electrically connected thanks to scratching the paint when screws are tightened.



Mounting Plate

8 holes for earthing.

Standard solutions

Terminal boxes



Manufactured features

Earthing continuity protection through accessories



Door
Connection with cable (ECFA or ECFE) to the frame using ECF.

Mounting Plate
Connection with cable (ECFA or ECFE) to the frame using ECF.

Mounting Plate
Connection with cable (ECFA or ECFE) to the rear panel using ECP.

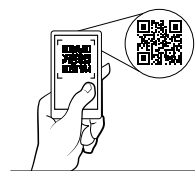

Door

Earthing studs in door in order to use earthing accessories.



Mounting Plate

4 holes for earthing.



EMC enclosures
**Combinable
enclosures**
(MCSE/MCDE)

Earthing continuity
protection through
accessories



Door
Connection with cable (ECFA or
ECFE) to the frame using ECF.

Side Panel
Connection with cable (ECFA or
ECFE) to the frame using ECF.

Roof
Connection with cable (ECFA or
ECFE) to the frame using ECF.

Rear Panel
Connection with cable (ECFA or
ECFE) to the frame using ECF.

Mounting Plate
Connection with cable (ECFA or
ECFE) to the frame using ECF.

Mounting Plate
Connection with cable (ECFA or
ECFE) to the rear panel using ECF.





EMC enclosures
**Wall mounted
enclosures
(MASE)**

Earthing continuity
protection through
accessories



Door
Connection with cable (ECFA or
ECFE) to the frame using ECF.

Mounting Plate
Connection with cable (ECFA or
ECFE) to the frame using ECF.

Mounting Plate
Connection with cable (ECFA or
ECFE) to the rear panel using ECP.

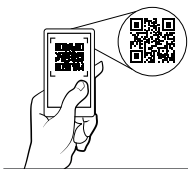

Connection to the frame through ECFP

Within floor standing range, any connection to the frame may be done using ECFP instead of ECF. This accessory is recommended when customer requires many earthing connections to the enclosure frame.

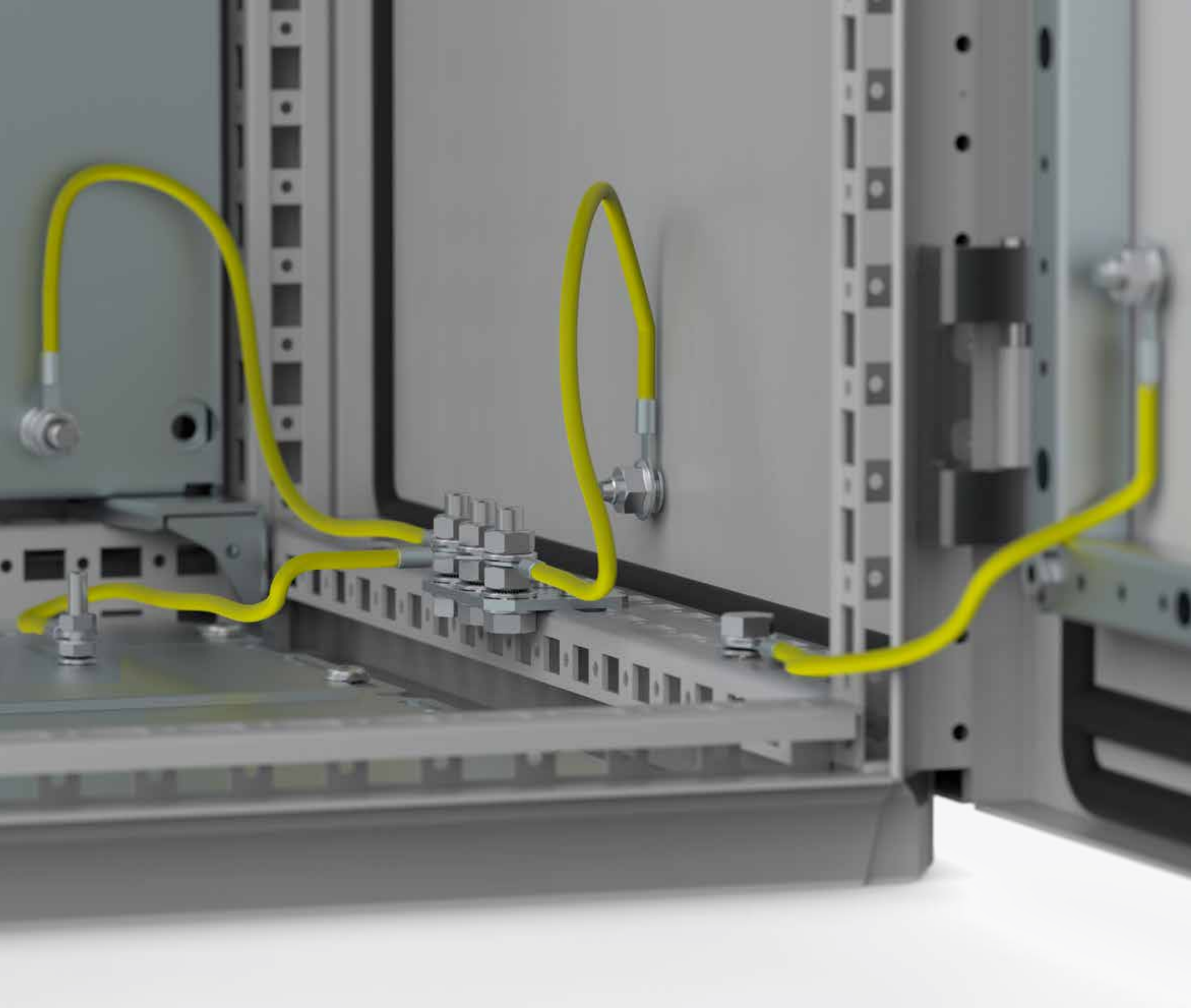

nVent HOFFMAN earthing test

nVent HOFFMAN has conducted a test to investigate the earthing connections in nVent HOFFMAN enclosures. The object was to test continuity and obtain values for the short-circuit resistance.

The aim of this document is to provide the planning engineer with data to enable fast and reliable implementation of the required adjustments at the project planning stage

Test Methods:

- The test material was connected to a power transformer and subjected to a short-circuit current over a defined period of time
- Before and after the short-circuit, the contact resistance was measured
- All the values were recorded
- The condition of the connections before and after the individual test was recorded or photographed

The tests were evaluated in that the electrical connection was examined visually and also measurements of the resistance where performed.

It should be noted further that the given values refer only to the tested structural elements and connections.

It must be noted that the layout of the connecting cables and the installations of the enclosure are important factors determining the arising current forces.

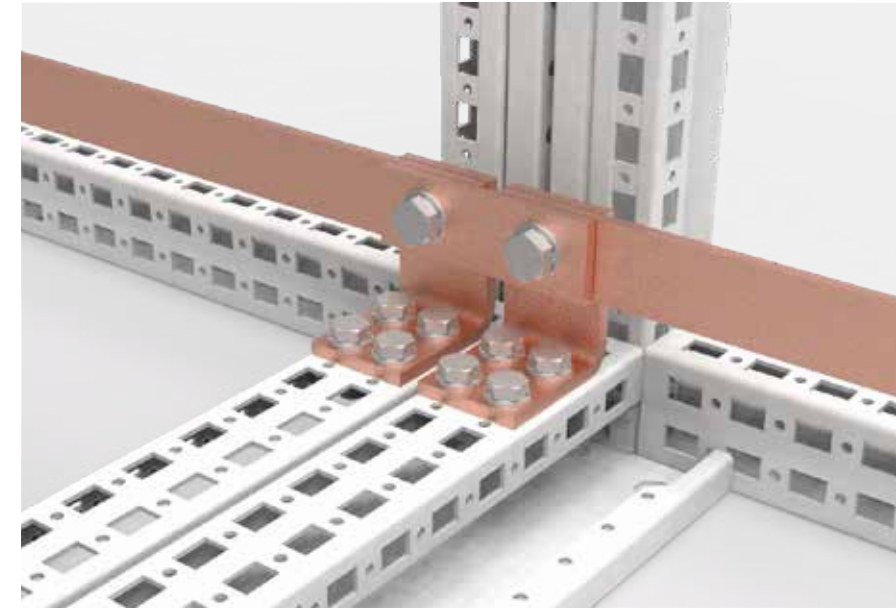

ECK

The PE/PEN copper angle is used together with the copper busbars. Supports are type tested as per 61439-1.

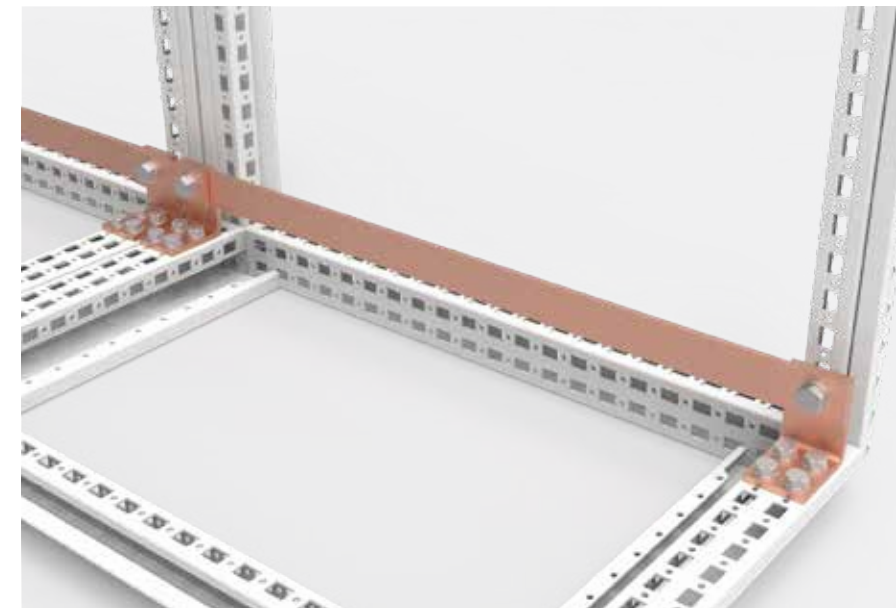

ECB

The PE/PEN copper angle is used together with the copper busbars. Supports are type tested as per 61439-1.

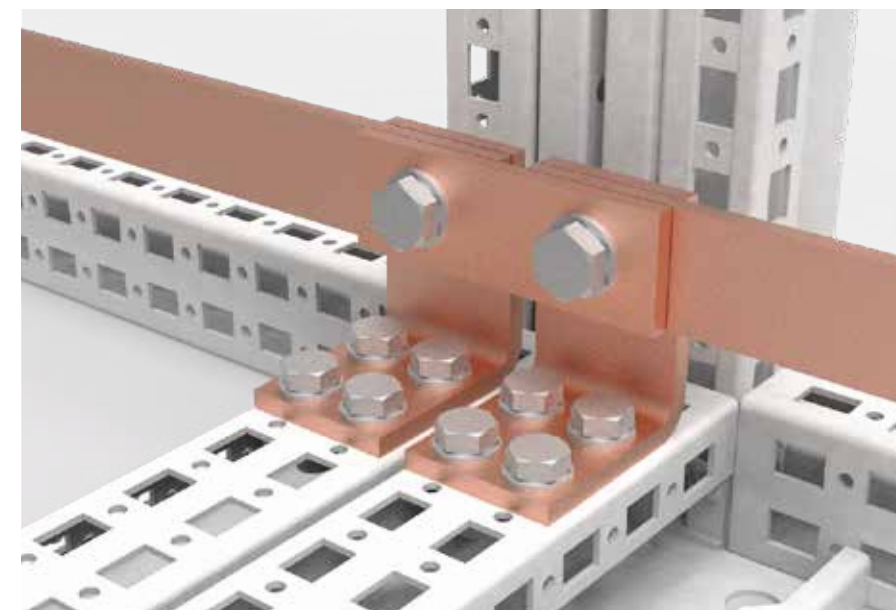

EBB

The PE/PEN copper angle is used together with the copper busbars. Supports are type tested as per 61439-1.

Floor standing enclosures

30x5 ECK, ECB, EBB

Rated peak withstand current	l _{pk}	36 kA
Rated short time withstand current	l _{cw}	18 kA
Duration		1 sec

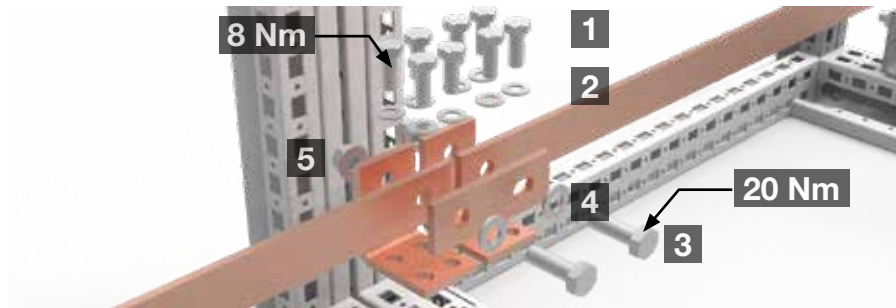

1	2	3	4	5
Hexagon screw M8x20	Plain washer M8	Hexagon screw M10x30	Plain washer M10	Flange nut serrated M10

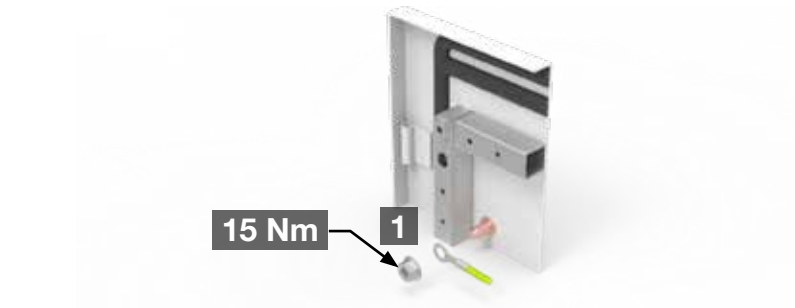

1
Flange nut serrated M8

Earthing stud door M8 with earthing nut

Rated peak withstand current	l _{pk}	36 kA
Rated short time withstand current	l _{cw}	18 kA
Duration		73 ms

30x10 ECK, ECB, EBB

Rated peak withstand current	l _{pk}	63 kA
Rated short time withstand current	l _{cw}	30 kA
Duration		1 sec

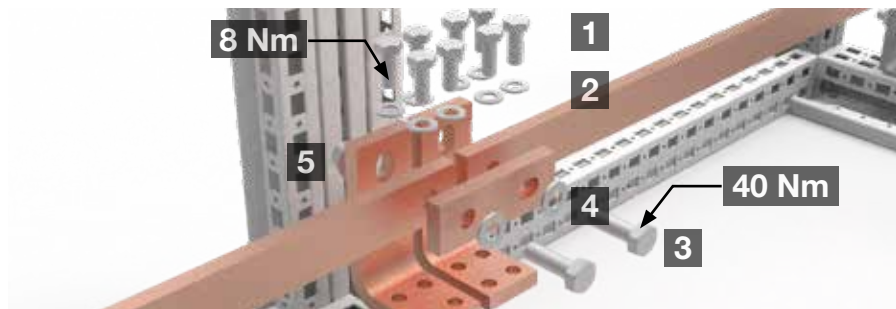

1	2	3	4	5
Hexagon screw M8x20	Plain washer M8	Hexagon screw M12x50	Plain washer M10	Flange nut serrated M10

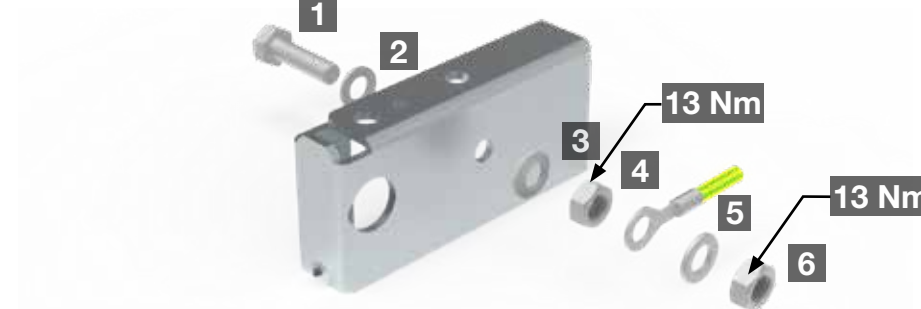

1	2	3	4	5	6
Hexagon screw M8x30	Plain washer M8	Earthing washer M8	Nut M8	Plain washer M8	Nut M8

Mounting plate with ECP08

Rated peak withstand current	l _{pk}	36 kA
Rated short time withstand current	l _{cw}	18 kA
Duration		54 ms

40x10 ECK, ECB, EBB

Rated peak withstand current	l _{pk}	105 kA
Rated short time withstand current	l _{cw}	50 kA
Duration		1 sec

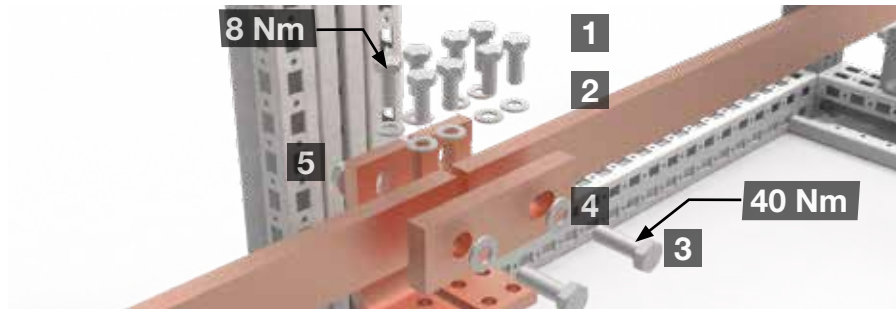

1	2	3	4	5
Hexagon screw M8x20	Plain washer M8	Hexagon screw M12x50	Plain washer M10	Flange nut serrated M10

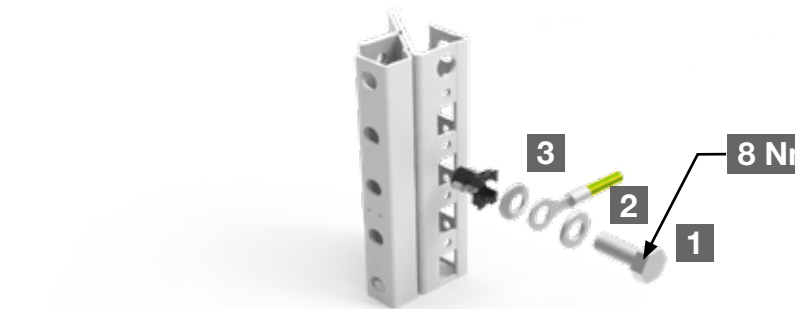

1	2	3
Hexagon screw M8x20	Plain washer M8	Earthing washer M8

Frame with ECF08

Rated peak withstand current	l _{pk}	4 kA
Rated short time withstand current	l _{cw}	2,0 kA
Duration		50 ms

80x10 ECK, ECB, EBB

Rated peak withstand current	l _{pk}	105 kA
Rated short time withstand current	l _{cw}	50 kA
Duration		1 sec

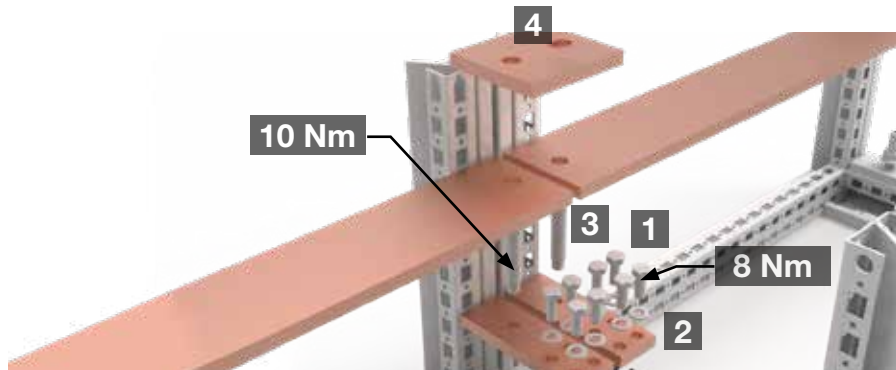

1	2	3	4
Hexagon screw M8x20	Plain washer M8	Pin torx bolt M10x9,5/M12x45	Flange nut serrated M12

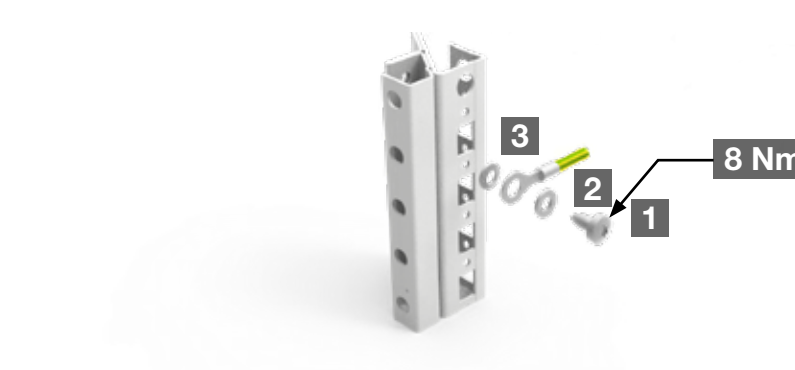

1	2	3
Extrude-tite M6x12	Plain washer M8	Earthing washer M8

Frame with M6 Metric screw

Rated peak withstand current	l _{pk}	10.2 kA
Rated short time withstand current	l _{cw}	6 kA
Duration		50 ms

Floor standing enclosures

Bottom plate with ECP06

Rated peak withstand current Ipk 15,4 kA

Rated short time withstand current Icw 9 kA

Duration 50 ms

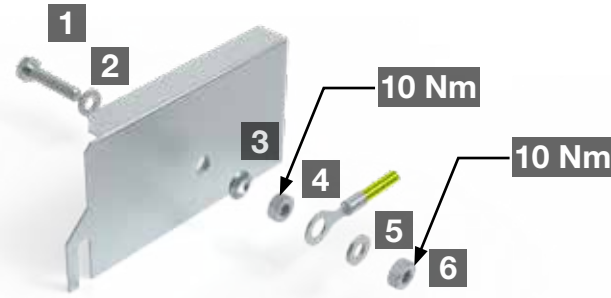

1	2	3	4	5	6
Hexagon screw M6x30	Plain washer M6	Earthing washer M6	Nut M6	Plain washer M6	Nut M6

Swing frame with ECP08

Rated peak withstand current Ipk 15,3 kA

Rated short time withstand current Icw 9 kA

Duration 50 ms

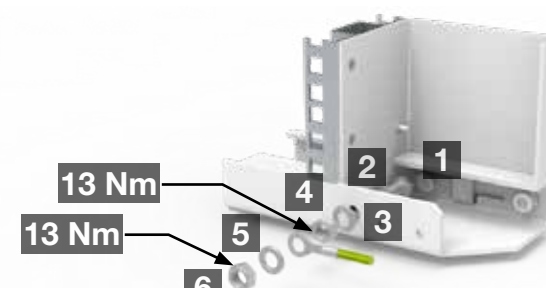

1	2	3	4	5	6
Hexagon screw M8x30	Plain washer M8	Earthing washer M8	Nut M8	Plain washer M8	Nut M8

Frame with ECF08

Rated peak withstand current Ipk 15,4 kA

Rated short time withstand current Icw 9 kA

Duration 50 ms

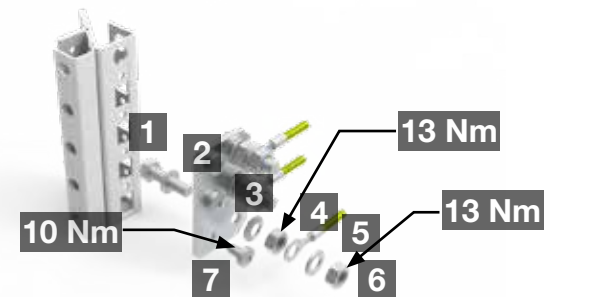

1	2	3	4	5	6	7
Hexagon screw M8x30	Plain washer M8	Earthing washer M8	Nut M8	Plain washer M8	Nut M8	Extrude-tite M6x12

Plinth Option A:

Rated peak withstand current Ipk 44,1 kA

Rated short time withstand current Icw 21 kA

Duration 50 ms

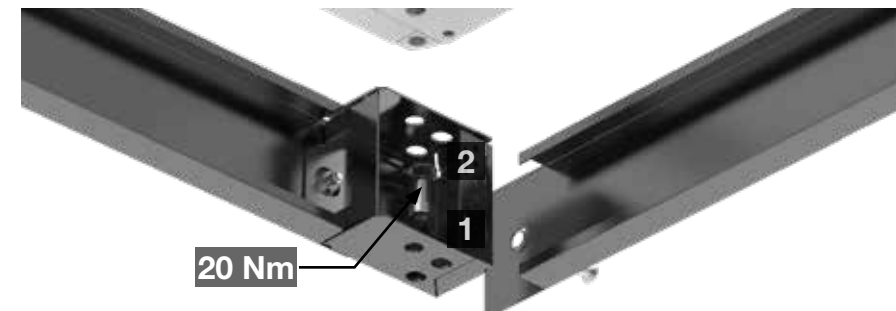

1	2
Hexagon screw M12x20	Serrated washer M12

CLPK mounted on frame

Rated peak withstand current Ipk 20 kA

Rated short time withstand current Icw 10 kA

Duration 50 ms

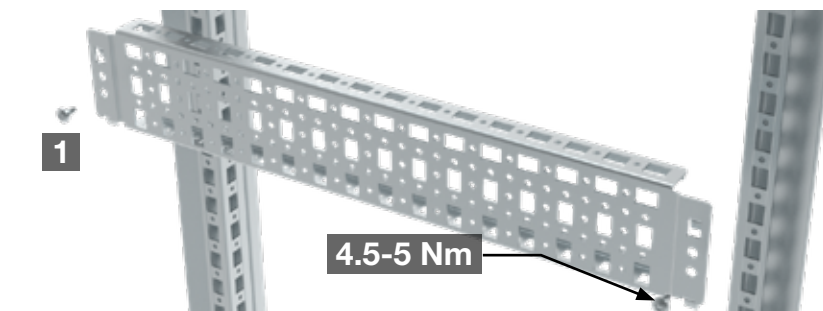

1
Hexagon screw M8x20

Plinth Option B:

Rated peak withstand current Ipk 44,1 kA

Rated short time withstand current Icw 21 kA

Duration 50 ms

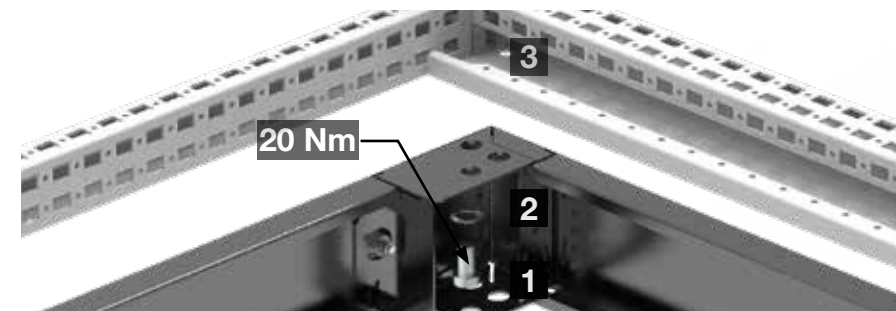

1	2	3
Hexagon screw M12x20	Serrated washer M12	Nut M12

CLPF with ECF08

Rated peak withstand current Ipk 10,2 kA

Rated short time withstand current Icw 6 kA

Duration 50 ms

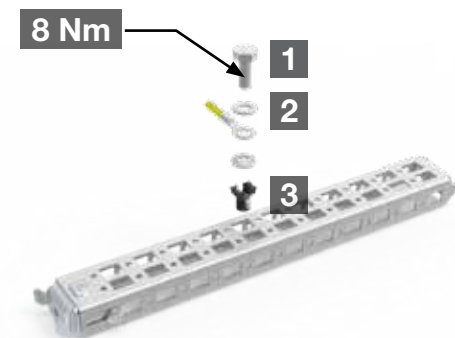

1	2	3
Hexagon screw M8x20	Plain washer M8	Earthing washer M8

Earthing stud body M8

Rated peak withstand current Ipk 36 kA

Rated short time withstand current Icw 18 kA

Duration 73 ms

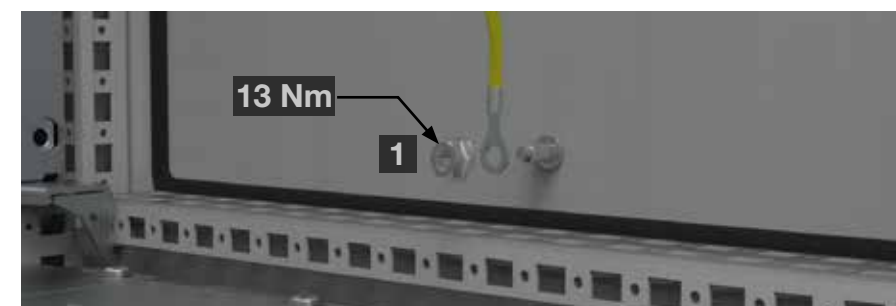

1
Flange nut serrated M8

Wall mounted enclosures

Earthing stud door M8 with earthing nut

Rated peak withstand current	Ip	36 kA
Rated short time withstand current	Icw	18 kA
Duration		73 ms



1
Flange nut serrated M8

Mounting plate with ECP08

Rated peak withstand current	Ip	36 kA
Rated short time withstand current	Icw	18 kA
Duration		54 ms

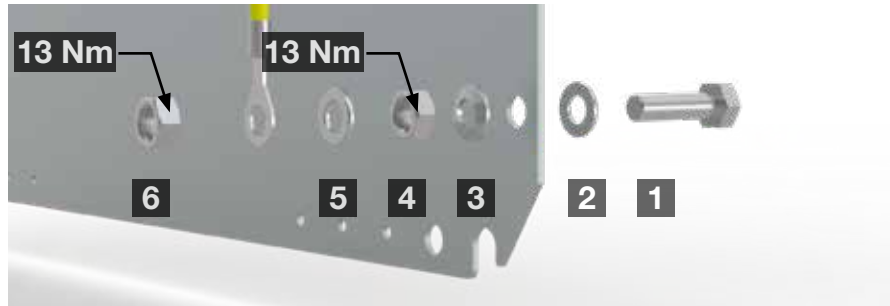

1 Hexagon screw M8x30	2 Plain washer M8	3 Earthing washer M8	4 Nut M8	5 Plain washer M8	6 Nut M8
--------------------------	----------------------	-------------------------	-------------	----------------------	-------------

Earthing stud body M8 with earthing nut

Rated peak withstand current	Ip	36 kA
Rated short time withstand current	Icw	18 kA
Duration		73 ms



1
Flange nut serrated M8

Gland plate with ECP08

Rated peak withstand current	Ip	15,3 kA
Rated short time withstand current	Icw	9 kA
Duration		50 ms

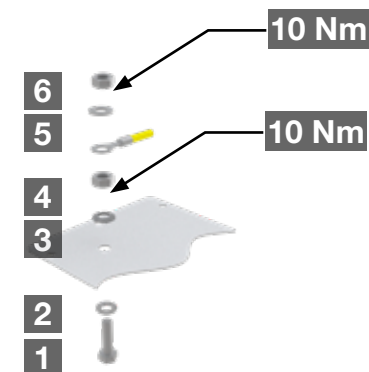

1 Hexagon screw M8x30	2 Plain washer M8	3 Earthing washer M8	4 Nut M8	5 Plain washer M8	6 Nut M8
--------------------------	----------------------	-------------------------	-------------	----------------------	-------------

Method of calculating the cross-sectional area of protective conductors

The following formula shall be used to calculate the cross-section of the protective conductors necessary to withstand the thermal stresses due to currents with a duration of the order of where

$$S_p = \sqrt{I^2 t / k}$$

S_p is the cross-sectional area, in square millimeters

I is the value (r.m.s.) of a.c. fault current for a fault of negligible impedance which can flow through the protective device, in amperes;

t is the operating time of the disconnecting device, in seconds;

k is the factor dependent on the material of the protective conductor, the insulation and other parts and the initial and final temperatures, see the below table.

Material of conductor	Thermo-plastic	Bare conductors
Copper	143	176

The initial temperature of the conductor is assumed to be 30°o C

Earthing straps, PVC insulated

Permissible symmetrical short-circuit current on earthing straps using the formula

Break time of protective device (in seconds)	Cross-section of PE conductor (PVS insulation)				
	4 mm*2	10 mm*2	16 mm*2	25 mm*2	35 mm*2
0.04 s	2.86 kA	7.15 kA	11.44 kA	17.88 kA	25.03 kA
0.2 s	1.28 kA	3.20 kA	5.12 kA	8.00 kA	11.20 kA
0.5 s	0.81 kA	2.02 kA	3.23 kA	5.05 kA	7.07 kA
1.0 s	0.57 kA	1.43 kA	2.29 kA	3.58 kA	5.01 kA
5.0 s	0.26 kA	0.64 kA	1.02 kA	1.60 kA	2.24 kA

Earthing straps, bare conductor

Permissible symmetrical short-circuit current on earthing straps using the formula

Break time of protective device (in seconds)	Cross-section of PE conductor (bare conductor)				
	4 mm*2	10 mm*2	16 mm*2	25 mm*2	35 mm*2
0.04 s	3,52kA	8.79kA	14.07kA	21.99kA	30.79kA
0.2 s	1.57kA	3.93kA	6.30kA	9.84kA	13.78kA
0.5 s	1.00kA	2.48kA	3.97kA	6.21kA	8.70kA
1.0 s	0.70kA	1.76kA	2.82kA	4.40kA	6.16kA
5.0 s	0.32kA	0.79kA	1.25kA	1.97kA	2.76kA

Our powerful portfolio of brands:

CADDY ERICO HOFFMAN RAYCHEM SCHROFF TRACER



eldon.com
nVent.com/HOFFMAN