

# KÄRCHER

makes a difference

## K 3 Full Control

English

### Operating Instructions

Please read the operating instructions carefully before using the unit.



59675750 (05/17)

# Contents

Contents . . . . .	2
Safety instructions . . . . .	3
Description of the Appliance . . . . .	8
Proper use . . . . .	9
Environmental protection . . . . .	9
Installation and Startup . . . . .	9
Operation . . . . .	10
Transport and storage . . . . .	10
Maintenance and care . . . . .	11
Troubleshooting . . . . .	11
Accessories and Spare Parts . . . . .	11
Warranty . . . . .	11
Technical specifications . . . . .	11
Customer Service . . . . .	12
Illustration . . . . .	13

## Safety instructions

 Please read and comply with these original instructions prior to the initial operation of your appliance and store them for later use or subsequent owners.

Apart from the notes contained herein the general safety provisions and rules for the prevention of accidents of the legislator must be observed.

Warnings and notes that are attached on the appliance provide important notes for the safe operation.

### Hazard levels

#### **DANGER**

Pointer to immediate danger, which leads to severe injuries or death.

#### **WARNING**

Pointer to a possibly dangerous situation, which can lead to severe injuries or death.

#### **CAUTION**

Pointer to a possibly dangerous situation, which can lead to minor injuries.

#### **ATTENTION**

Pointer to a possibly dangerous situation, which can lead to property damage.

## Electric components

### **DANGER**

Risk of electric shock.

- Never touch the mains plug and the socket with wet hands.
- Check the power cord with mains plug for damage prior to every use. Immediately have damaged power cord replaced by an authorised customer service / electrician. Do not operate an appliance if the power cord is damaged.
- All current-conducting parts in the working area must be protected against jet water.
- The mains plug and the coupling of an extension cable must be watertight and must never lie in water. Moreover, the coupling may never lie on the ground. The use of cable reels that ensure that the sockets are at least 60 mm above the ground is recommended.
- Make sure that the power cord or extension cable is not damaged by running over, pinching, dragging or the like. Protect the power cords from heat, oil, and sharp edges.
- Turn off the appliance and remove the mains plug prior to any care and maintenance works.
- Repair work and work on the electrical components may only be performed by an authorised customer service.

## **⚠ WARNING**

- *The appliance may only be connected to an electric supply that has been installed by an electrician in accordance with IEC 60364.*
- *The appliance may only be connected to alternating current. The voltage must correspond with the type plate of the appliance.*
- *For safety reasons, we recommend that you operate the appliance only via a residual current device (max. 30 mA).*
- *An unsuitable electrical extension cable can be hazardous. Only use an electrical extension cable which has been approved and labelled for this purpose and has an adequate cable cross-section outdoors: 1 - 10 m: 1.5 mm<sup>2</sup>; 10 - 30 m: 2.5 mm<sup>2</sup>*
- *Always fully unreel the extension cable from the cable drum.*

## **Safe handling**

### **⚠ DANGER**

- *The user must use the appliance as intended. The person must consider the local conditions and must pay attention to other persons in the vicinity when working with the appliance.*
- *Check important components, such as high-pressure hose, hand spray gun and safety installations, for damage prior to every operation. Immediately replace damaged components. Do not operate appliance with damaged components.*
- *High-pressure jets can be dangerous if improperly used. The jet may not be directed at persons, animals, live electrical equipment or at the appliance itself.*
- *The high-pressure jet must not be directed at other persons or the user him-/herself to clean clothing or footwear.*
- *Vehicle tyres/tyre valves are susceptible to damage from the high-pressure jet and may burst. The first indication for this is a discolouration of the tyre. Damaged vehicle tyres/tyre valves are perilous. Keep a minimum jet distance of 30 cm during cleaning!*

### **△ WARNING**

- *Do not use the appliance when there are other persons around unless they are also wearing protective clothing.*
- *The appliance must not be operated by children or persons who have not been instructed accordingly.*
- *This appliance is not intended for use by persons with limited physical, sensory or mental capacities or lacking experience and/or skills, unless such persons are accompanied and supervised by a person in charge of their safety or they have received precise instructions on the use of this appliance and have understood the resulting risks.*
- *Children must not play with this appliance.*
- *Supervise children to prevent them from playing with the appliance.*

### **△ CAUTION**

- *Create stability for the appliance prior to any work on or with the appliance to prevent accidents or damage.*
- *The water jet that is emitted from the high-pressure nozzle results in a repulsion power acting on the hand spray gun. Make sure that you have a firm footing and are also holding the hand spray gun and spray lance firmly.*
- *Never leave the appliance unattended as long as it is in operation.*

### **ATTENTION**

- *In case of extended breaks, switch the appliance off at the main switch / appliance switch or pull the mains plug.*
- *Do not operate the appliance at temperatures below 0 °C.*

### **Working with detergent**

#### **△ WARNING**

- *This appliance was designed to be used with detergents which are supplied or recommended by the manufacturer. The use of other detergents or chemicals may compromise the safety of the appliance.*
- *The improper use of detergents can cause severe injuries or toxication.*
- *Store detergents away from the reach of children.*

## Other risks

### **⚠ DANGER**

- *The appliance may not be operated in explosive atmospheres.*
- *Never use the appliance to clean objects containing hazardous substances (e.g. asbestos).*
- *Do not spray flammable liquids.*
- *Never draw in fluids containing solvents or undiluted acids and solvents! This includes petrol, paint thinner and heating oil. The spray mist is highly inflammable, explosive and poisonous. Do not use acetone, undiluted acids and solvents, as they corrode the materials used on the appliance.*
- *Keep packaging films away from children, there is a risk of suffocation!*

### **⚠ WARNING**

- *According to applicable regulations, the appliance must never be used on the drinking water net without a system separator. Ensure that the connection of your building water installation on which the high-pressure cleaner is operated is equipped with a system separator pursuant to EN 12729 Type BA.*

- *Water that has flown through a system separator is no longer classified as drinking water.*
- *High-pressure hoses, fixtures and couplings are important for the safety of the appliance. Only use high-pressure hoses, fixtures and couplings recommended by the manufacturer.*
- *When disconnecting the supply or high pressure hose, hot water may leak from the connections after operation.*

### **⚠ CAUTION**

- *Mind the weight of the appliance when selecting the storage location and during transport (see technical data) to prevent accidents or injuries.*
- *Several hours of continuous use of the appliance can lead to numbness in the hands in rare cases.*
- ➔ *Wear gloves.*
- ➔ *Keep hands warm.*
- ➔ *Take breaks at regular intervals.*

## Safety Devices

### **⚠ CAUTION**

- *Safety installations serve the protection of the user and may not be modified or bypassed.*

### **Power switch**

*The appliance switch prevents unintentional operation of the appliance.*

### **Lock trigger gun**

*This lock locks the lever of the trigger gun and prevents the inadvertent start of the appliance.*

### **Overflow valve with pressure switch**

*If the lever on the trigger gun is released the pressure switch turns off the pump, the high pressure jet is stopped. If the lever is pulled the pump is turned on again.*

## Symbols on the machine



*The high pressure jet must not be directed at persons, animals, live electrical equipment or at the appliance itself. Protect the appliance against frost.*



*The appliance must not be directly connected to the public drinking water network.*

## Personal protective equipment

### **⚠ CAUTION**

- *Wear protective clothing and safety goggles to protect against splash back containing water or dirt.*
- *During the use of high-pressure cleaners aerosols can develop. Inhaling aerosols can cause health damage.*
  - *Depending on the application, completely shielded nozzles (e.g. surface cleaner) that significantly reduce the emission of aqueous aerosols can be used for high-pressure cleaning.*
  - *The use of such shielding is not possible with all applications.*
  - *If the use of a completely shielded nozzle is not possible, a respirator of the category FFP 2 or the like should be used, depending on the environment to be cleaned.*

# Description of the Appliance

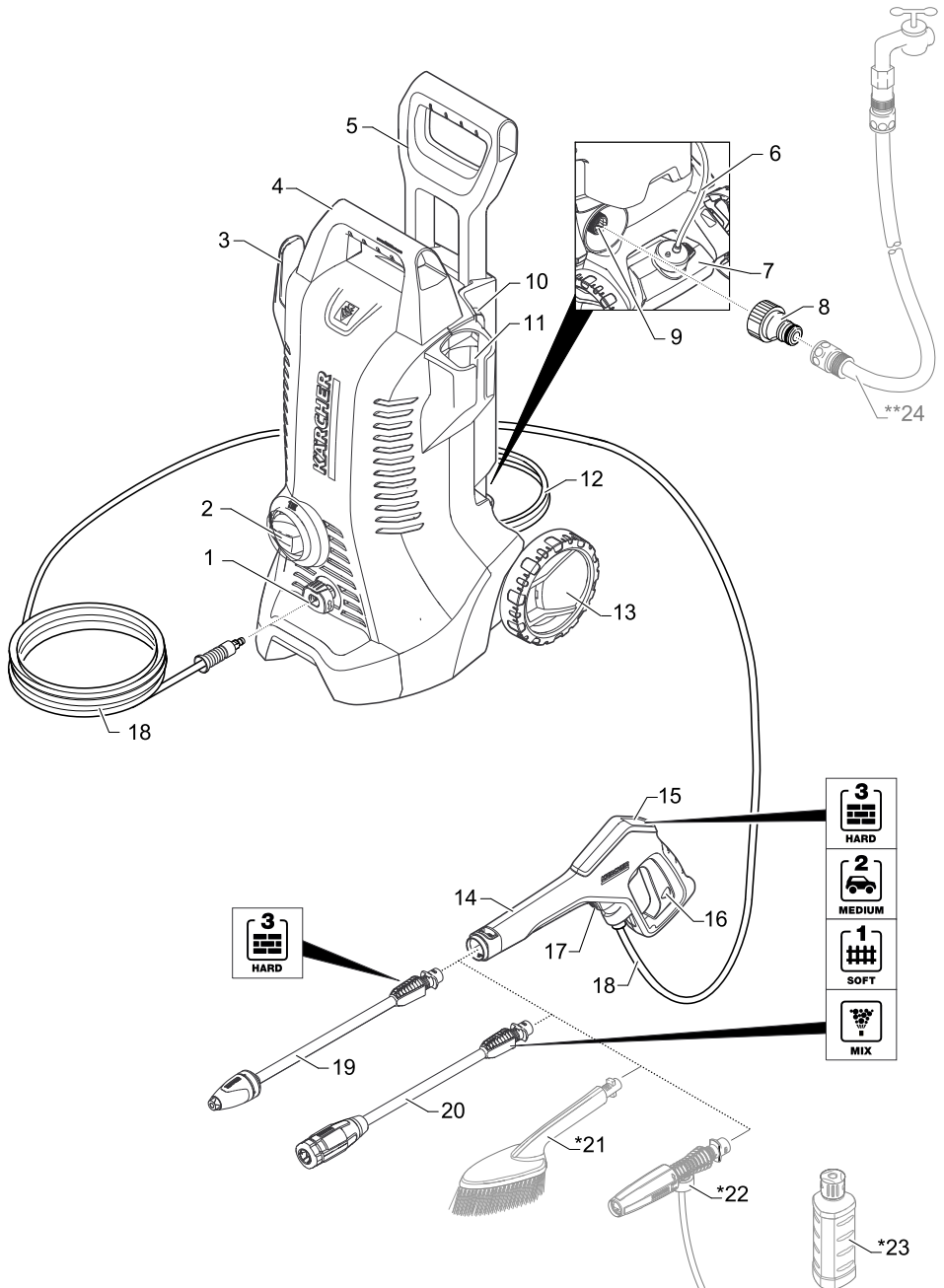

## Description of the Appliance

The scope of delivery of the device (depending on the model) is illustrated on the packaging. These operating instructions describe all possible options.

### Illustrations on the picture pages

- 1 High pressure connection
- 2 Appliance switch „0/OFF“ / „1/ON“
- 3 Storage hook
- 4 Carrying handle
- 5 Transport handle, detachable
- 6 Detergent suction hose with detergent filter and lid
- 7 Detergent Tank
- 8 Coupling element for water connection
- 9 Water connection with integrated sieve
- 10 Storage for spray lance
- 11 Storage for trigger gun
- 12 Mains cable with mains plug
- 13 Bearing wheel
- 14 Full Control trigger gun
- 15 Pressure display  
0 - MIX / 1 - SOFT / 2 - MEDIUM / 3 - HARD
- 16 Lock trigger gun
- 17 Button for detaching the high-pressure hose from the trigger gun
- 18 High pressure hose
- 19 Full Control spray lance Dirtblaster  
For strong contaminations  
Pressure level: HARD
- 20 Full Control spray lance Vario Power  
Carrying out the most common cleaning tasks  
Pressure levels: HARD / MEDIUM / SOFT / MIX

### \* Optional

- 21 Washing brush  
Suitable for use with detergents.
- 22 Foam nozzle  
For effective detergent foam.
- 23 Detergent

### \*\* Additionally required

- 24 Fabric-reinforced water hose with commercially available coupling.
  - Minimum diameter, 1/2 inches (13 mm).
  - Minimum length 7.5 m.

## Proper use

This high pressure cleaner is designed for domestic use only.

- for cleaning machines, vehicles, buildings, tools, facades, terraces, gardening tools, etc. by means of a high-pressure water jet (if necessary, with additional cleaning agents).
- with accessories, replacement parts and cleaning agents approved by KÄRCHER. Please observe the information accompanying the cleaning agents.

## Environmental protection

### Notes about the ingredients (REACH)

You will find current information about the ingredients at:

[www.kaercher.com/REACH](http://www.kaercher.com/REACH)



The packaging material can be recycled. Please arrange for the environmentally appropriate disposal of the packaging.



Old appliances contain valuable recyclable materials that should be recycled properly. Batteries and accumulators contain substances that must not enter the environment. Please dispose of old devices and batteries or accumulators in an environmentally friendly way.



Cleaning operations which produce oily waste water, e.g. engine washes, underbody washes, may only be carried out using washing stations equipped with an oil separator.



Work with detergents must only be performed on liquid-tight work surfaces with a connection to the sewer system. Do not let release detergent into waters or earth.

## Installation and Startup

### Illustrations on the picture pages

- Illustration **A B C**  
Mount loose parts delivered with appliance prior to start-up.
- Park the appliance on an even surface.
- Illustration **D**  
Push the high pressure hose into the trigger gun until it locks audibly.  
Check the secure connection by pulling on the high pressure hose.
- Illustration **E F G**

### ATTENTION

*Impurities in the water can damage the high-pressure pump and the accessories. For protection, the use of the KÄRCHER water filter (optional accessory, order no. 4.730-059) is recommended.*

## Operation

### ⚠ CAUTION

Dry running of more than 2 minutes leads to damage of the high-pressure pump. If the appliance does not build up pressure within 2 minutes, switch the appliance off and proceed in accordance with the instructions in Chapter "Troubleshooting".

### High pressure operation

### ⚠ CAUTION

Keep a distance of at least 30 cm when using the jet for cleaning painted surfaces to avoid damage.

### ATTENTION





Car tyres, paint or sensitive surfaces such as wood should not be cleaned with the dirt blaster, as there is a risk of damage.

→ Illustration **H I**

### Full Control System

The pressure indicator on the trigger gun shows the currently set pressure level during operation with a Full Control spray lance.

**Note:** The pressure indicator is not significant during operation with the T-Racer and other accessories.

Pressure level	For example, recommended for	
	<b>HARD</b>	Stone terraces made of paving stones or exposed aggregate concrete, asphalt, metal surfaces, garden utensils (wheelbarrow, spade, etc.)
	<b>MEDIUM</b>	Motorcar / motorcycle, brick surfaces, plastered walls, plastic furniture
	<b>SOFT</b>	Wooden surfaces, bicycles, sand stone surfaces, rattan furniture
	<b>MIX</b>	Operation with detergent

### ATTENTION

The sensitivity of the materials can strongly differ depending on the age and the condition. The so-called recommendations are non-binding.

### Operation with detergent

**Note:** Detergent can only be added when the device is operated in low pressure mode.

→ Illustration **J K**

### Optional

→ Illustration **L**

### Recommended cleaning method

- Spray the detergent sparingly on the dry surface and allow it to react, but not to dry.
- Spray off loosened dirt with the high pressure jet.

### After operation with detergent

- After operation with detergent: Run the machine for approximately 1 minute for a clear rinse.

## Operation with washing brush

### ATTENTION

Risk of damage to the paintwork

When working with the washing brush, it must be free of dirt or other particles.

**Note:** If required, the washing brushes can be used to work with detergent.

### Interrupting operation

→ Illustration **M**

Release the lever of the trigger gun and lock it.

→ During longer breaks (more than 5 minutes), also turn the appliance off using the "0/OFF" switch.

### Finish operation

### ⚠ CAUTION

Only separate the high-pressure hose from the trigger gun or the device when there is no pressure in the system.

- Release the lever of the trigger gun.
- Turn off the appliance "0/OFF".
- Disconnect the mains plug from the socket.
- Turn off tap.
- **Press the lever on the trigger gun to release any remaining pressure in the system.**
- Lock the lever of the trigger gun.
- Detach the appliance from the water supply.

## Transport and storage

### ⚠ CAUTION

Risk of personal injury or damage!

Mind the weight and storage of the appliance during transport.

### When transporting by hand

- Lift appliance by the carrying handle and carry it.
- Pull out the transport handle until it audibly snaps into place.  
Pull the appliance by its transport handle.

### When transporting in vehicles

- Secure the appliance against shifting and tipping over.

### Storing the Appliance

- Park the machine on an even surface.
- Stow away the accessories on the appliance according to the device.

Prior to extended storage periods, as during the winter, also observe the instructions in the Care section.

### Frost protection

### ATTENTION

Appliances and accessories that are not completely drained can be destroyed by frost. Completely drain appliance and accessories and protect them against frost. To avoid damage:

- Completely drain all water from the appliance: Switch the appliance on with detached high pressure hose and detached water supply (max. 1 minute) and wait, until no more water exits at the high pressure connection. Turn off the appliance.
- Store the appliance and the entire accessories in a frost free room.

## Maintenance and care

The appliance is maintenance free.

### Care

#### ⚠ **DANGER**

*Risk of electric shock.*

- ➔ Prior to all work on the appliance, switch off the appliance and pull the power plug.

#### High pressure hose

The high pressure hose is specially constructed with reinforced walls to handle water pressure up to 12 MPa (1700 psi) - it can be easily damaged and should be stored carefully.

- Do not kink.
- Do not drive vehicles over the hose.
- Do not expose the hose to sharp edges or corners.

Misuse will lead to ballooning or premature failure and will invalidate warranty.

#### Clean the sieve in the water connection

Clean the sieve in the water connection regularly.

#### **ATTENTION**

*The sieve must not be damaged.*

- ➔ Remove coupling from the water connection.

Illustration **N**

- ➔ Pull the sieve out (e.g. using flat pliers), clean under running water and then reinsert it.

## Troubleshooting

#### ⚠ **DANGER**

*Risk of electric shock.*

- ➔ Prior to all work on the appliance, switch off the appliance and pull the power plug.

### Appliance is not running

- ➔ Push the lever of the trigger gun, the device will switch on.
- ➔ Check whether the voltage indicated on the type plate corresponds to the voltage of the mains supply.
- ➔ Check the mains connection cable for damages.

### Pressure does not build up in the appliance

- ➔ Check setting at the spray lance.
- ➔ Completely open the water tap.
- ➔ Remove air from appliance before operation. Switch on the appliance without connection the HP hose (max. 2 minutes) and run it until the water discharging from the HP outlet is free of bubbles. Switch off appliance and reconnect HP hose.
- ➔ Pull out the sieve in the water connection using flat-nose pliers and clean under running water.

### Strong pressure fluctuations

- ➔ Clean high-pressure nozzle: Remove dirt and debris from the nozzle bore, using a needle and rinse through with water from the front.
- ➔ Check water flow quantity.

### Appliance is leaking

- ➔ Slight leakage from the appliance pump is normal. If the leakage increases contact the authorized customer service.

### No detergent infeed

- ➔ Use Vario Power spray lance. Turn the spray lance to "Mix" position.

- ➔ Remove filter from suction hose for detergent and clean under running water.
- ➔ Check the detergent suction hose for kinks.

## Accessories and Spare Parts

Only use original accessories and spare parts, they ensure the safe and trouble-free operation of the device. For information about accessories and spare parts, please visit [www.kaercher.com](http://www.kaercher.com).

## Warranty

The warranty terms published by the relevant sales company are applicable in each country. We will repair potential failures of your appliance within the warranty period free of charge, provided that such failure is caused by faulty material or defects in manufacturing. In the event of a warranty claim please contact your dealer or the nearest authorized Customer Service centre. Please submit the proof of purchase.

Addresses can be found under: [www.kaercher.com/dealersearch](http://www.kaercher.com/dealersearch)

## Technical specifications

### Electrical connection

Voltage	220-240 V 1~50-60 Hz
Power consumption	1,7 kW
Protection class	IP X5
Protective class	II 
Mains fuse (slow-blow)	10 A

### Water connection

Max. feed pressure	1,2 MPa
Max. feed temperature	40 °C
Min. feed volume	8 l/min

### Performance data

Working pressure	9 MPa
Max. permissible pressure	12,5 MPa 1800 psi

Water flow rate	5,5 l/min
Max. flow rate	6,3 l/min
Detergent flow rate	0,3 l/min
Recoil force of trigger gun	12 N

### Dimensions and weights

Length	307 mm
Width	272 mm
Height	600 mm

Weight, ready to operate with accessories

1.602-603.0	5,5 kg
1.602-609.0, 1.602-610.0	5,6 kg

### Values determined as per EN 60335-2-79

Hand-arm vibration value	<2,5 m/s <sup>2</sup>
Uncertainty K	0,6 m/s <sup>2</sup>
Sound pressure level L <sub>pA</sub>	72 dB(A)
Uncertainty K <sub>pA</sub>	3 dB(A)
Sound power level L <sub>WA</sub> + Uncertainty K <sub>WA</sub>	88 dB(A)

Subject to technical changes.

## Customer Service

### Australia

KÄRCHER Pty. Ltd.  
40 Koornang Road  
Scoresby, Victoria 3179

1800 675 714 (Free Call)  
[www.karcher.com.au](http://www.karcher.com.au)

# Illustration

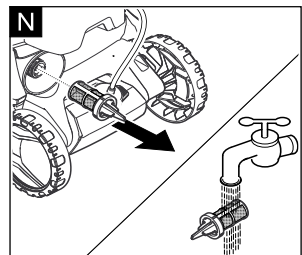
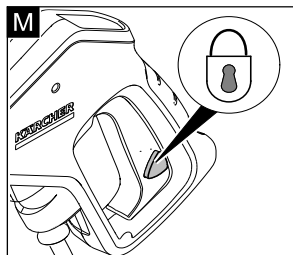
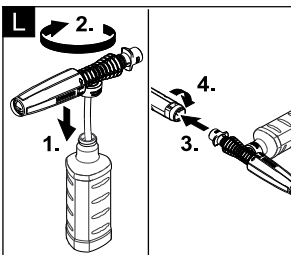
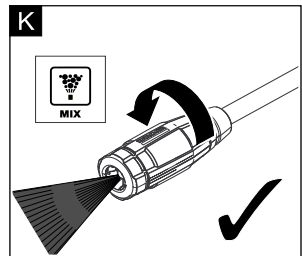
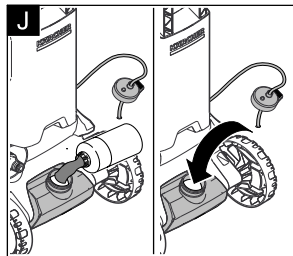
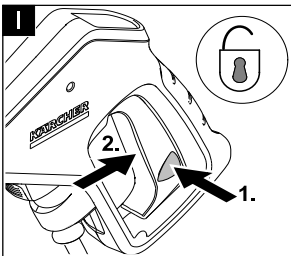
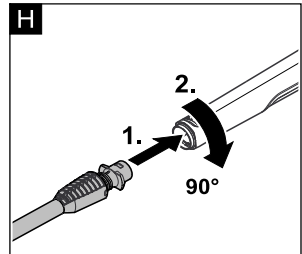
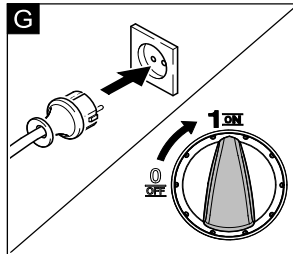
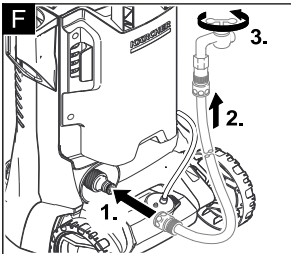
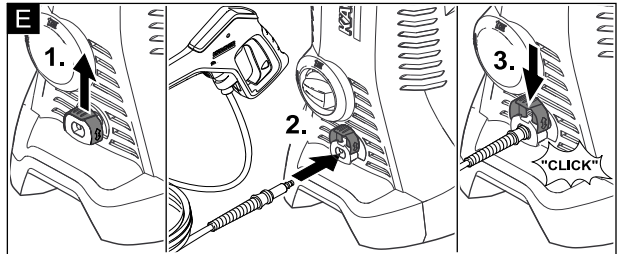
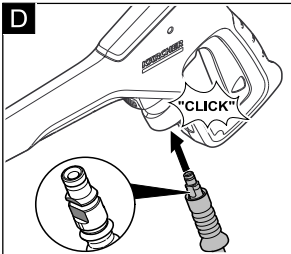
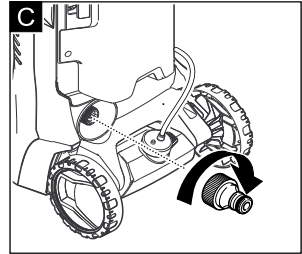
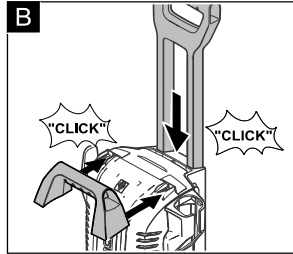
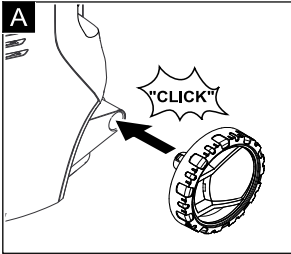







<http://www.kaercher.com/dealersearch>

