



Barella Lantern Range E27

Lanterns

Data Sheet

Product Information

The Barella E27 lantern Range is a classy modern style range for both domestic & commercial applications, with varying styles to complement each other & their surroundings, in a Black finish that will take an E27 halogen or LED lamp.

Product Features

- 1 year warranty
- Class I
- IP44
- E27 40W max.
- Suitable for E27 LED filament lamps
- Not suitable for high saline areas
- Product supplied less lamp
- Black Finish

Product Specification

Product Code	Product Description	Max Wattage (W)	Lamp Cap	Energy Efficiency Class	Protection Class
KSR1930	Barella Single E27 Wall Lantern Black	40	E27	Lamp Dependant	I
KSR1931	Barella Twin E27 Wall Lantern Black	2 x 40	E27	Lamp Dependant	I
KSR1932	Barella Single E27 PIR Wall Lantern Black	40	E27	Lamp Dependant	I
KSR1933	Barella II Single E27 Wall Lantern Black	40	E27	Lamp Dependant	I
KSR1934	Barella S E27 Wall Lantern Black	40	E27	Lamp Dependant	I
KSR1935	Barella L E27 Wall Lantern Black	40	E27	Lamp Dependant	I
KSR1936	Barella L E27 Pillar Lantern Black	40	E27	Lamp Dependant	I

Nominal voltage	220~240VAC
Operating frequency	50-60Hz
IP rating	44

Construction

Body: Aluminium
Lens: Glass / Polycarbonate

Standards

BSEN60598-1:2021 Luminaires – Part 1: General requirements and tests

In Conformity with

LVD Low voltage directive 2014/35/EU
RoHS Restriction of hazardous substances 2015/863/EU

Product Dimensions

KSR1930

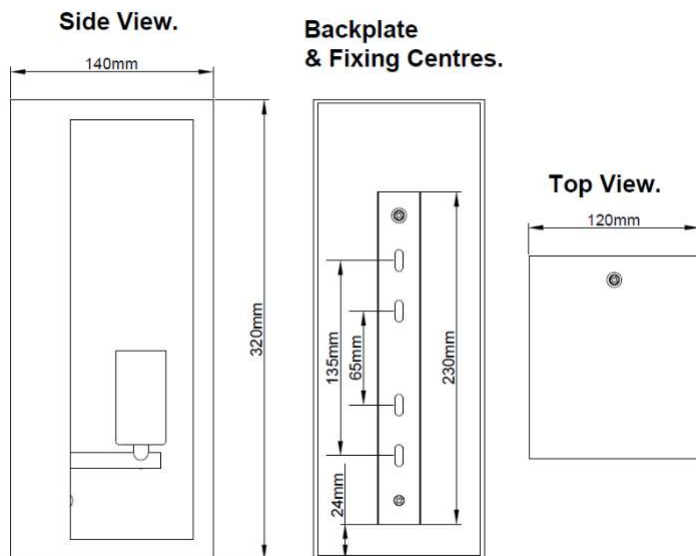

KSR1931

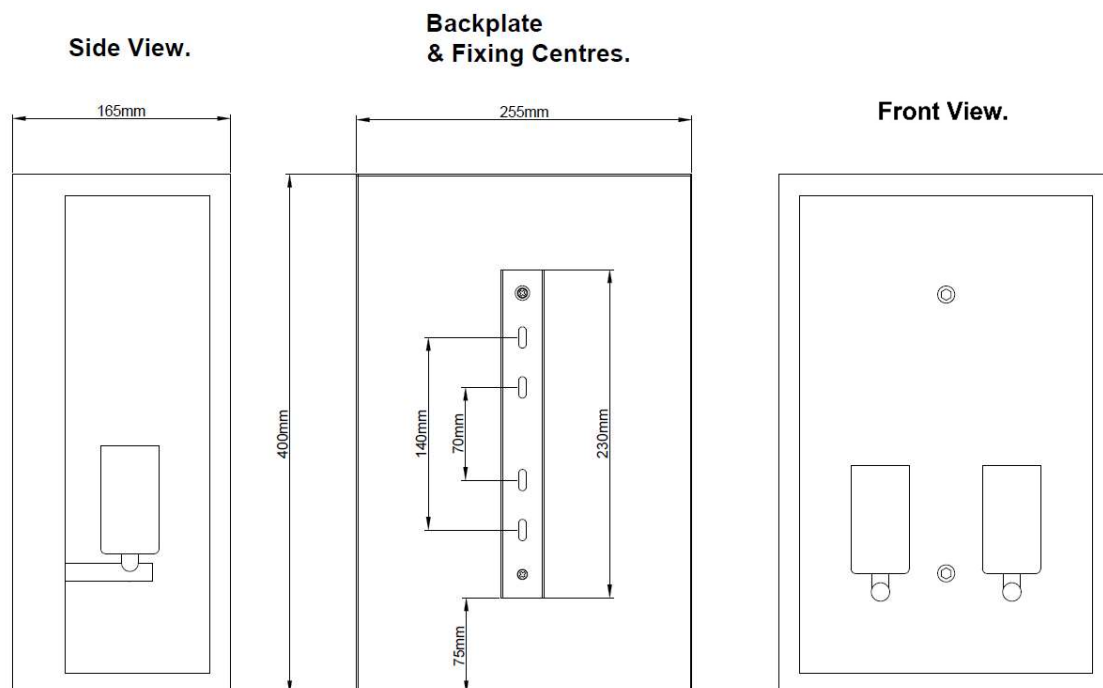

KSR1932

Side View.

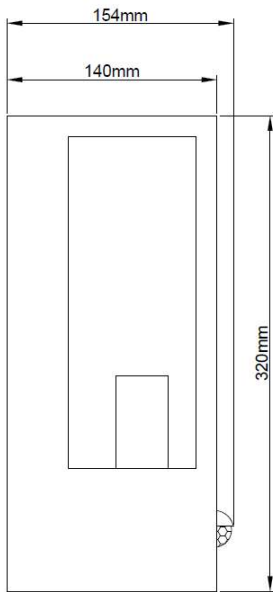

Backplate & Fixing Centres.

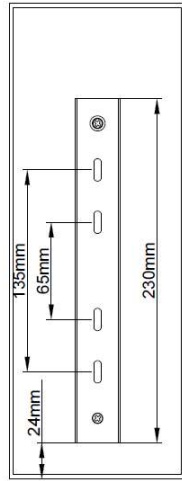

Top View.

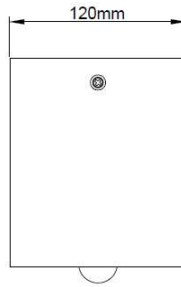

KSR1933

Side View.

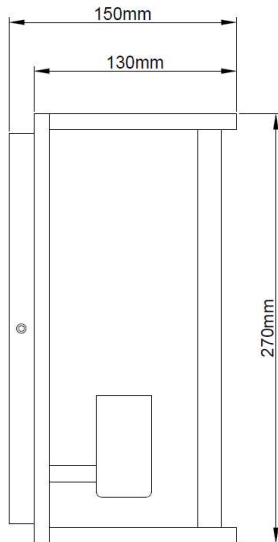

Backplate & Fixing Centres.

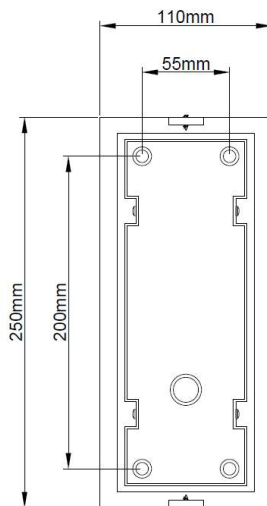

Top View.

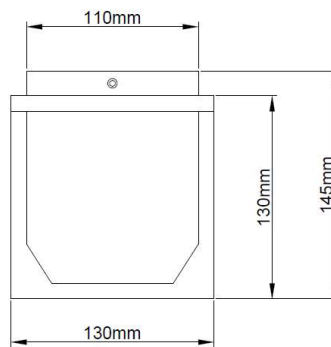

KSR1934

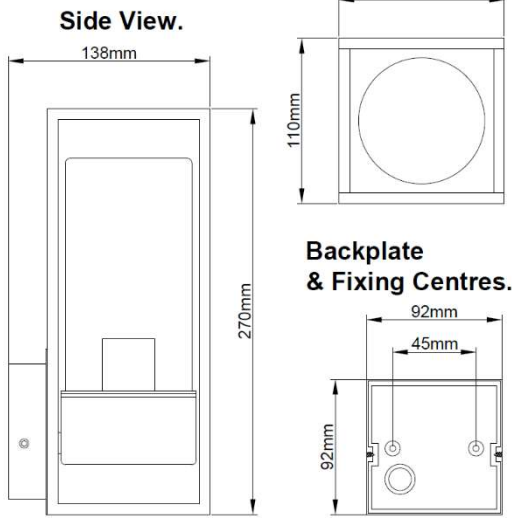

KSR1935

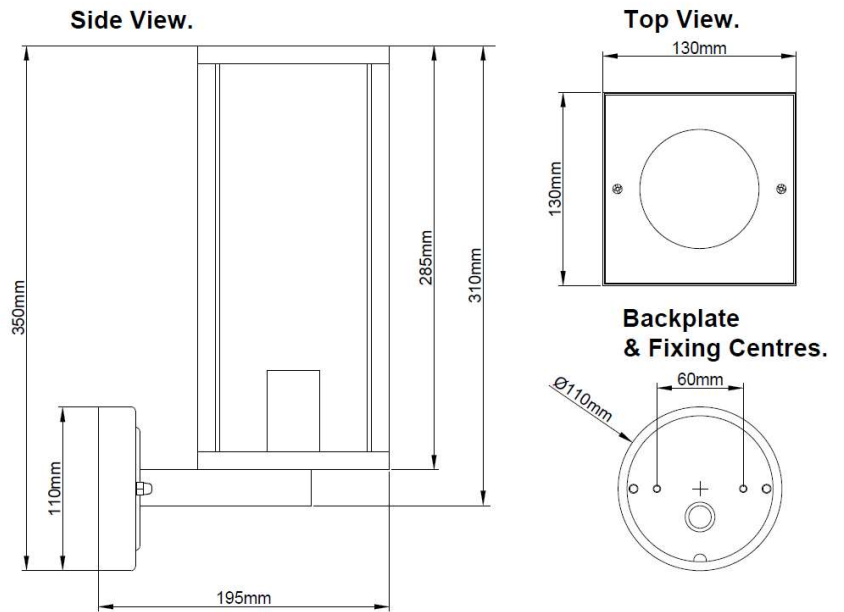

KSR1936

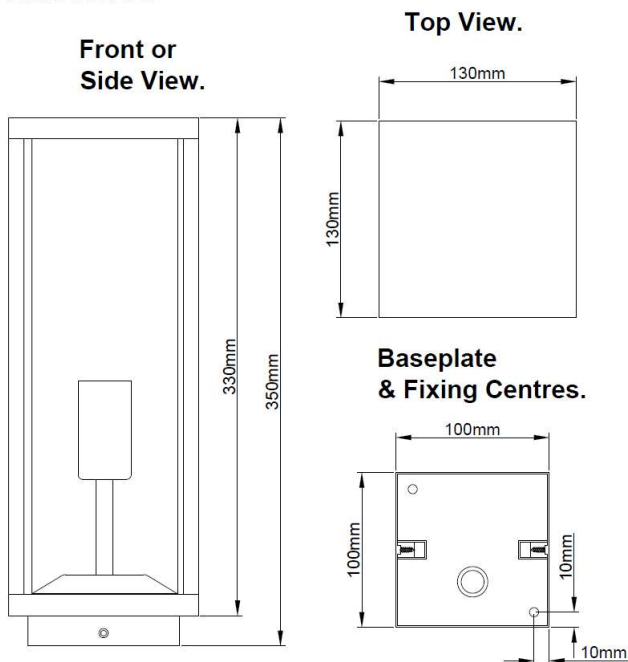

KSR Lighting is constantly developing and improving its products. For this reason, all product descriptions in this data sheet are intended as a general guide, and KSR may change specifications from time to time in the interest of product development, without prior notification or public announcement. All descriptions in this data sheet present only general particulars of the goods to which they refer and shall not form part of any contract. Data in this guide has been obtained in controlled experimental conditions. However, KSR Lighting cannot accept any liability arising from the reliance on such data to the extent permitted.