

Short form catalogue

Power breakers

Tmax moulded case circuit breakers

Power breakers

Tmax Moulded case circuit breakers



Contents

Overview	4
Distribution solutions	8
Energy measurement and communication solutions	10
Automatic network generator transfer solutions	12
Motor protection solutions	14
Construction characteristics	16
Release characteristics	18
Tmax XT1	20
Tmax XT2	22
Tmax XT4	23
T5	25
T6	26
T7	27
Tmax disconnectors	29
Accessories	
Overview	30
Tmax XT1 ... XT4 & T1 ... T7	32

Power breakers

A single family of moulded case circuit breakers up to 3200 A

Tmax moulded-case circuit-breakers guarantee an extremely high performance level while being progressively smaller in size, simple to install and able to provide increasingly better safety guarantees for the operator.

In addition to being ideal for the secondary distribution of alternate and direct current, they feature dedicated solutions for all application requirements.

Moulded-case circuit-breakers can be used in low voltage civil and industrial installations with 1 to 3200 A operating current. The Tmax family includes 9 circuit-breaker sizes in three- or four-pole versions:

- XT1, XT2, XT3 and XT4 up to 250A;
- T4, T5 and T6 up to 1000A;
- T7 and T8 up to 3200A.

The ultimate short-circuit breaking capacity (I_{cu}) at 415V ranges from 18kA to 200kA, or up to 100kA for 690V.

The following ranges are available:

- Circuit-breakers for AC and DC power distribution;
- Circuit-breakers for zone selectivity;
- Circuit-breakers for motor protection;
- Circuit-breakers for up to 1150V AC and 1000V DC applications;
- Switch-disconnectors.

All Tmax circuit breakers can be enhanced with a vast range of standardized accessories. This convenience not only cuts down on inventory, but creates an extremely flexible and easily managed solution.

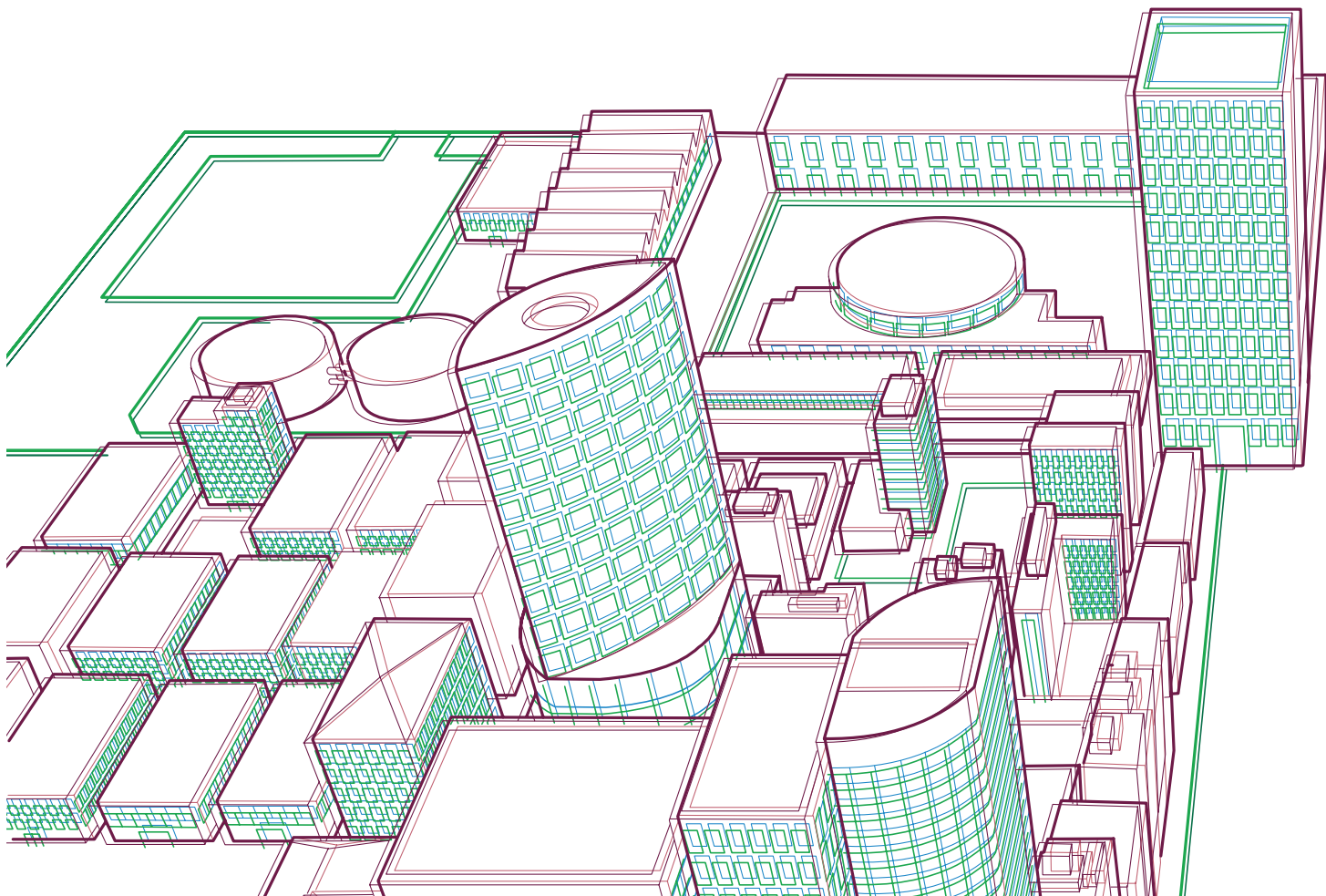

Tmax circuit-breakers can be equipped with thermomagnetic, solely magnetic or electronic trip units; all of which are interchangeable.

Since assembly instructions are simple, trip units can quickly and easily be replaced; even in the field.

All this makes the circuit-breakers very easy to operate with considerable savings due to rationalized stock management.

Up to 250 A



Up to 1000 A



Up to 3200 A

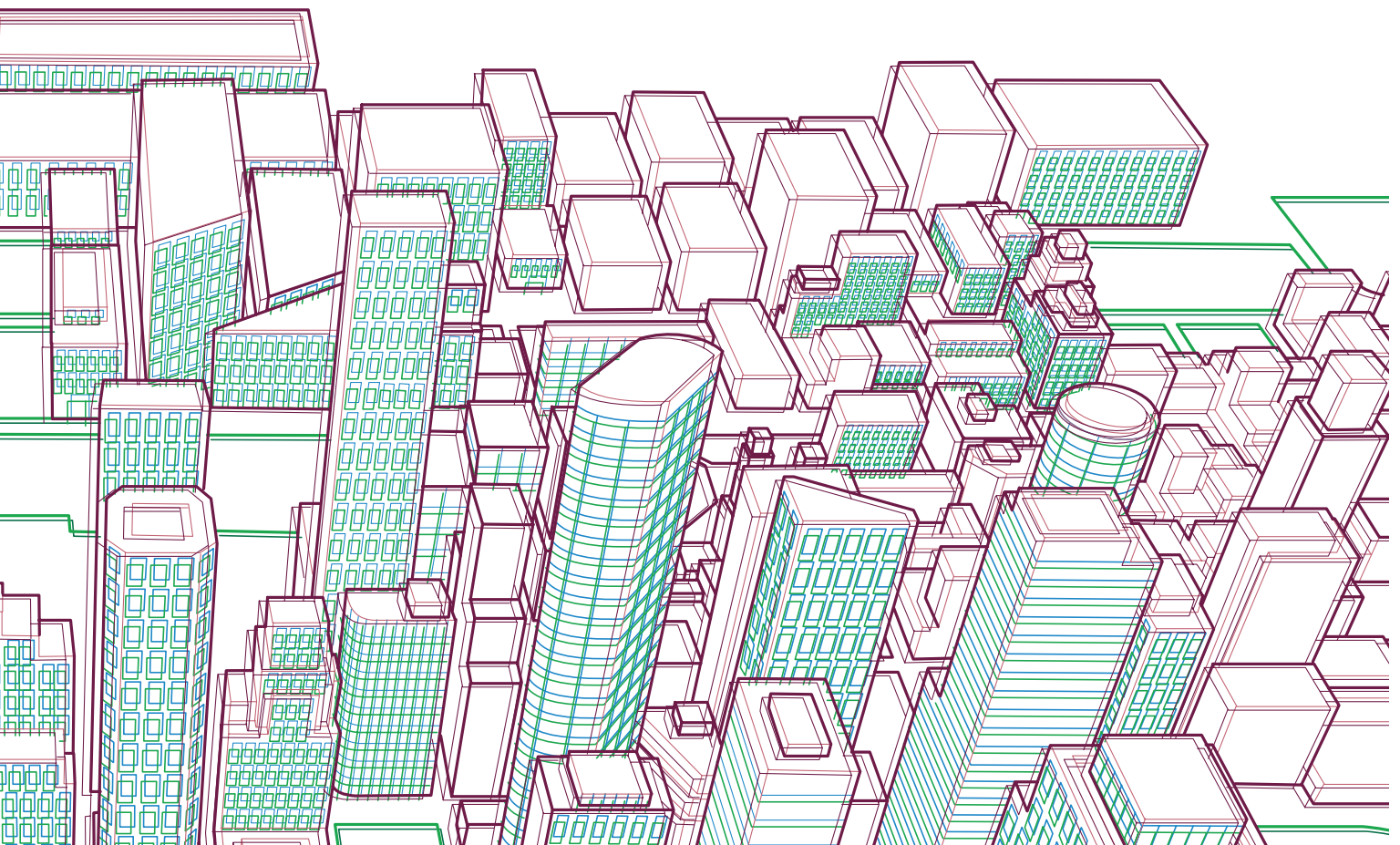

Power breakers

Moulded case circuit breakers overview

Up to 250 A

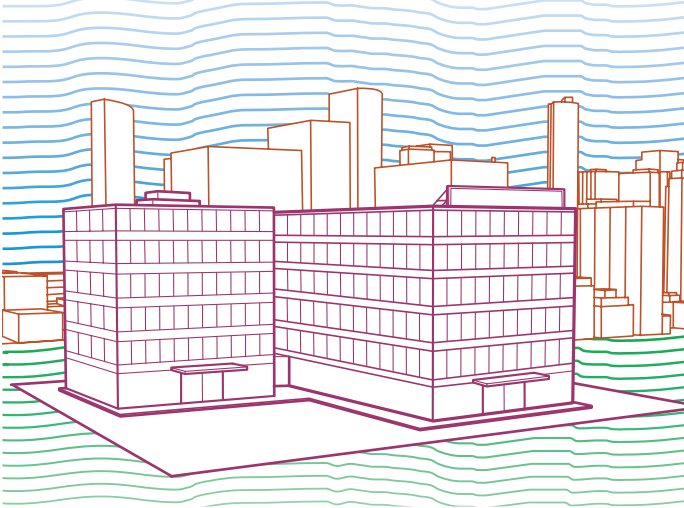

SACE Tmax

Size	[A]
Rated service voltage, Ue	(AC) 50-60Hz [V] (DC) [V]
Versions	
Breaking capacity according to IEC 60947-2	
Rated ultimate short-circuit breaking capacity, Icu	
Icu @ 220-230-240V 50-60Hz (AC)	[kA]
Icu @ 415V 50-60Hz (AC)	[kA]
Icu @ 690V 50-60Hz (AC)	[kA]
(DC) 500V - 2 poles in series	[kA]
(DC) 500V - 3 poles in series	[kA]
(DC) 750V - 3 poles in series	[kA]
Rated service short-circuit breaking capacity, Ics	
Ics @ 220-230-240V 50-60Hz (AC)	[kA]
Ics @ 415V 50-60Hz (AC)	[kA]
Ics @ 690V 50-60Hz (AC)	[kA]
Mechanical life	[N° Operations] [N° Hourly operations]
Electrical life @ 415V (AC)	[N° Operations] [N° Hourly operations]
Dimensions	3 poles [mm] 4 poles [mm]
(Width/Depth/Height)	

Up to 1000 A

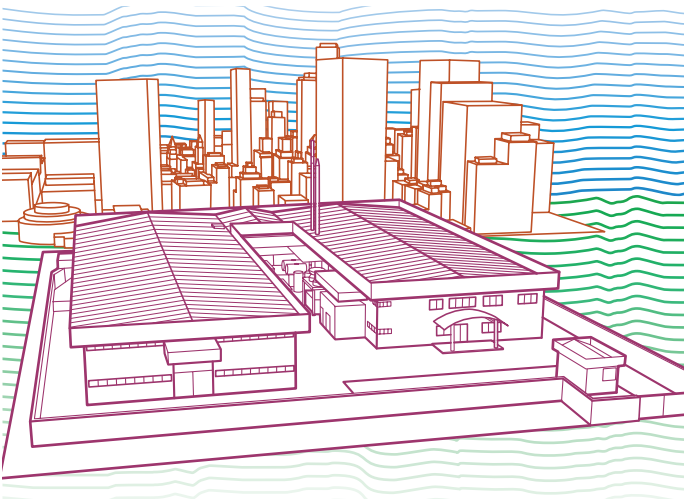

SACE Tmax

Size	[A]
Rated service voltage, Ue	(AC) 50-60Hz [V] (DC) [V]
Versions	
Breaking capacity according to IEC 60947-2	
Rated ultimate short-circuit breaking capacity, Icu	
Icu @ 220-230-240V 50-60Hz (AC)	[kA]
Icu @ 415V 50-60Hz (AC)	[kA]
Icu @ 690V 50-60Hz (AC)	[kA]
(DC) 500V - 2 poles in series	[kA]
(DC) 500V - 3 poles in series	[kA]
(DC) 750V - 3 poles in series	[kA]
Rated service short-circuit breaking capacity, Ics	
Ics @ 220-230-240V 50-60Hz (AC)	[kA]
Ics @ 415V 50-60Hz (AC)	[kA]
Ics @ 690V 50-60Hz (AC)	[kA]
Mechanical life	[N° Operations] [N° Hourly operations]
Electrical life @ 415V (AC)	[N° Operations] [N° Hourly operations]
Dimensions	3 poles [mm] 4 poles [mm]
(Width/Depth/Height)	

Up to 3200 A

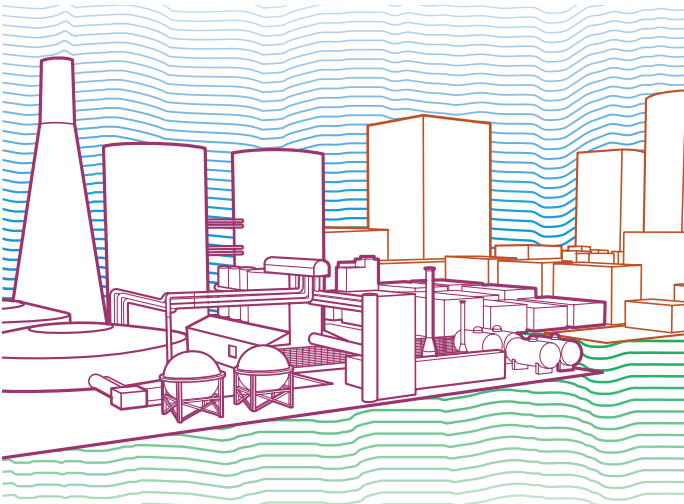

SACE Tmax

Size	[A]
Rated service voltage, Ue	(AC) 50-60Hz [V] (DC) [V]
Versions	
Breaking capacity according to IEC 60947-2	
Rated ultimate short-circuit breaking capacity, Icu	
Icu @ 220-230-240V 50-60Hz (AC)	[kA]
Icu @ 415V 50-60Hz (AC)	[kA]
Icu @ 690V 50-60Hz (AC)	[kA]
(DC) 500V - 2 poles in series	[kA]
(DC) 500V - 3 poles in series	[kA]
(DC) 750V - 3 poles in series	[kA]
Rated service short-circuit breaking capacity, Ics	
Ics @ 220-230-240V 50-60Hz (AC)	[kA]
Ics @ 415V 50-60Hz (AC)	[kA]
Ics @ 690V 50-60Hz (AC)	[kA]
Mechanical life	[N° Operations] [N° Hourly operations]
Electrical life @ 415V (AC)	[N° Operations] [N° Hourly operations]
Dimensions	3 poles [mm] 4 poles [mm]
(Width/Depth/Height)	

XT1					XT2					XT3		XT4				
160					160					250		160/250				
690					690					690		690				
500					500					500		500 ⁽⁴⁾				
Fixed, Plug-in ⁽¹⁾					Fixed, Plug-in, Withdrawable					Fixed, Plug-in		Fixed, Plug-in, Withdrawable				
B	C	N	S	H	N	S	H	L	V	N	S	N	S	L	H	V
25	40	65	85	100	65	85	100	150	200	50	85	65	85	100	150	200
18	25	36	50	70	36	50	70	120	150	36	50	36	50	70	120	150
3	4	6	8	10	10	12	15	18	20	5	6	10	12	15	20	25/100 ⁽²⁾
-	-	-	-	-	-	-	-	-	-	-	-	36	50	70	85	100
18 ⁽³⁾	25 ⁽³⁾	36 ⁽³⁾	50 ⁽³⁾	70 ⁽³⁾	36	50	70	85	100	36	50	36 ⁽⁴⁾	50 ⁽⁴⁾	70 ⁽⁴⁾	85 ⁽⁴⁾	100 ⁽⁴⁾
-	-	-	-	-	-	-	-	-	-	-	-	-	-	-	-	-
100%	100%	75%(50)	75%	75%	100%	100%	100%	100%	100%	75%	50%	100%	100%	100%	100%	100%
100%	100%	100%	75%	50% (37,5)	100%	100%	100%	100%	100%	75%	50% (27)	100%	100%	100%	100%	100%
100%	100%	100%	75%	50%	100%	100%	100%	75% (15)	75% (15)	75%	50%	100%	100%	100%	100%	75% (20)
25000					25000					25000		25000				
240					240					240		240				
8000					8000					8000		8000				
120					120					120		120				
76,2x70x130					90x82,5x130					105x70x150		105x82,5x160				
101,6x70x130					120x82,5x130					140x70x150		140x82,5x160				

T4					T5					T6				
320					400/630					630/800/1000				
690					690					690				
750					750					750				
Fixed, Plug-in, Withdrawable					Fixed, Plug-in, Withdrawable					Fixed, Withdrawable ⁽⁵⁾				
N	S	H	L	V	N	S	H	L	V	N	S	H	L	V ⁽⁶⁾
70	85	100	200	200	70	85	100	200	200	70	85	100	200	200
36	50	70	120	200	36	50	70	120	200	36	50	70	100	150
20	25	40	70	80	20	25	40	70	80	20	22	25	30	40
25	36	50	70	100	25	36	50	70	100	20	35	50	65	70
-	-	-	-	-	-	-	-	-	-	-	-	-	-	-
16	25	36	50	70	16	25	36	50	70	16	20	36	50	50
100%	100%	100%	100%	100%	100%	100%	100%	100%	100%	100%	100%	100%	75%	100%
100%	100%	100%	100%	100%	100%	100%	100%	100%	100%	100%	100%	100%	75%	75%
100%	100%	100%	100%	100%	100%	100%	100% ⁽⁷⁾	100% ⁽⁸⁾	100% ⁽⁸⁾	75%	75%	75%	75%	75%
20000					20000					20000				
240					120					120				
6000					7000 (400 A) - 5000 (630 A)					7000 (630A) - 5000 (800A) - 4000 (1000A)				
120					60					60				
105 x 103.5 x 205					140 x 103.5 x 205					210 x 103.5 x 268				
140 x 103.5 x 205					186 x 103.5 x 205					280 x 103.5 x 268				

T7					T8	
800/1000/1250/1600					2000/2500/3200	
690					690	
-					-	
Fixed, Withdrawable					Fixed	
S	H	L	V ⁽⁹⁾	X ⁽¹⁰⁾	L	V
85	100	200	200	170	85	130
50	70	120	150	170	85	130
30	42	50	60	75	50	80
-	-	-	-	-	-	-
-	-	-	-	-	-	-
-	-	-	-	-	-	-
100%	100%	100%	100%	100%	100%	75%
100%	100%	100%	100%	100%	100%	75%
100%	75%	75%	75%	100%	100%	75%
10000					15000	
60					60	
2000 (versioni S, H, L) / 3000 (versione V)					4500(2000A);4000 (2500A);3000 (3200A)	
60					20	
210 x 154 (leva) /178 (motorizzabile) x 268					427 x 282 x 382	
280 x 154 (leva) /178 (motorizzabile) x 268					553 x 282 x 382	

⁽¹⁾ XT1 plug-in In max=125A
⁽²⁾ 25kA@690V available for XT4 250; 100kA@690V available for XT4 160
⁽³⁾ XT1 500V DC 4 poles in series
⁽⁴⁾ XT4 750V DC ask ABB SACE whether available
⁽⁵⁾ Withdrawable not available for T6 1000A
⁽⁶⁾ V version only available for frame 630A/800A
⁽⁷⁾ 75% for T5 630
⁽⁸⁾ 50% for T5 630
⁽⁹⁾ Only for T7 800/1000/1250
⁽¹⁰⁾ Only for T7 800

Power breakers

Distribution solutions

1 - XT4 250 TMA 3p

Thermomagnetic trip unit TMA for AC/DC applications. Thermal protection is adjustable $I_1 = 0.7 \dots 1xI_n$, magnetic protection is adjustable $I_3 = 5 \dots 10xI_n$.



2 - XT1 160 TMD 3p with RC Sel

Thermomagnetic trip unit TMD for AC/DC applications. Thermal protection is adjustable $I_1 = 0.7 \dots 1xI_n$, magnetic protection is fixed $I_3 = 10xI_n$.



RC SEL is a selective residual current release for assembly in conjunction with the circuit-breaker. It has adjustable current thresholds and $2x\Delta n$ adjustable non-actuating times.



3 - T5S 630 PR221DS LS/I 3p

Electronic trip unit PR221DS LS/I for AC applications. Features a protection L function against overload with adjustable current, ($I_1 = 0.4 \dots 1xI_n$), and timing. Protection against short-circuit can be delayed (S), with an adjustable, or instantaneous delay (I). The tripping threshold is adjustable in both cases ($I_2, I_3 = 1 \dots 10xI_n$).

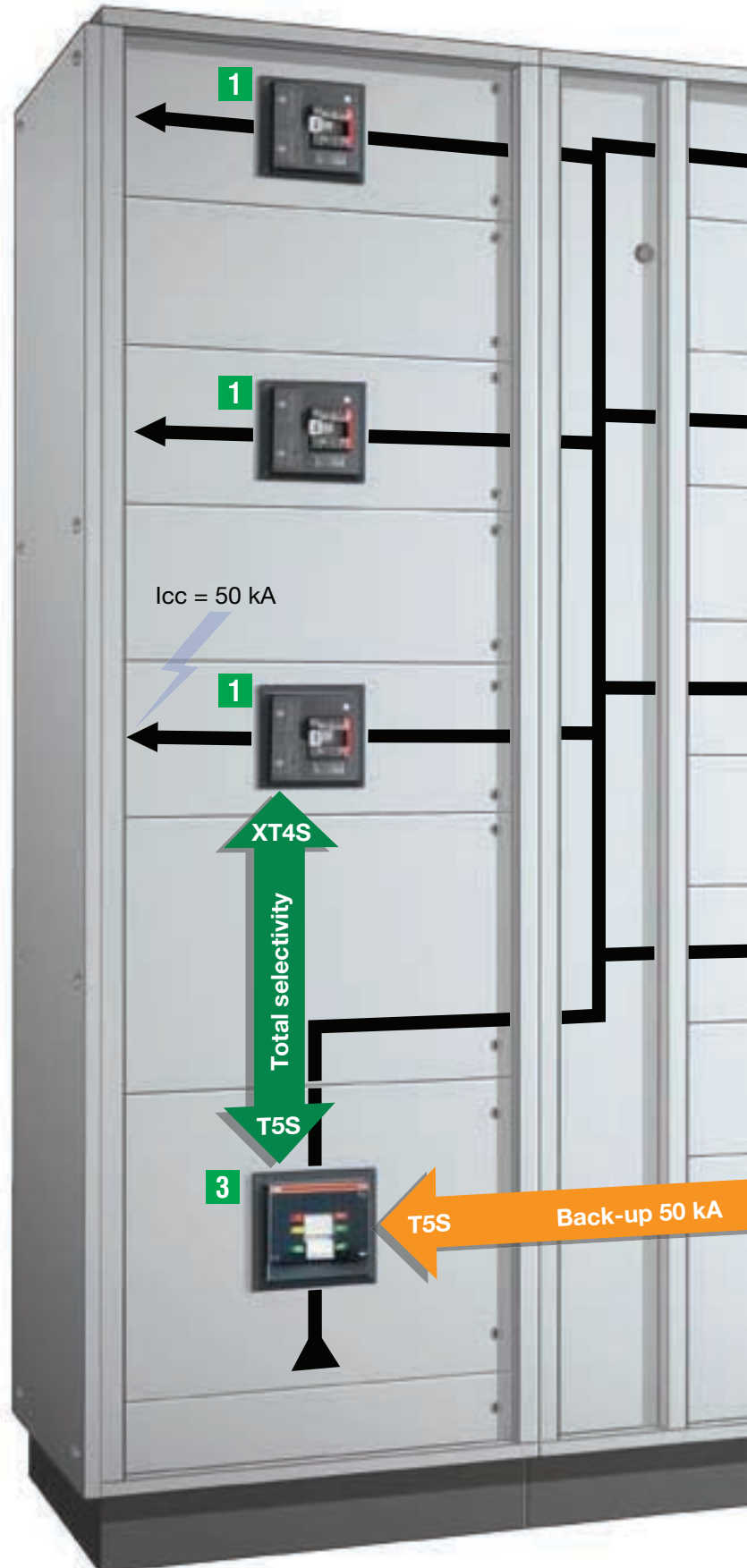

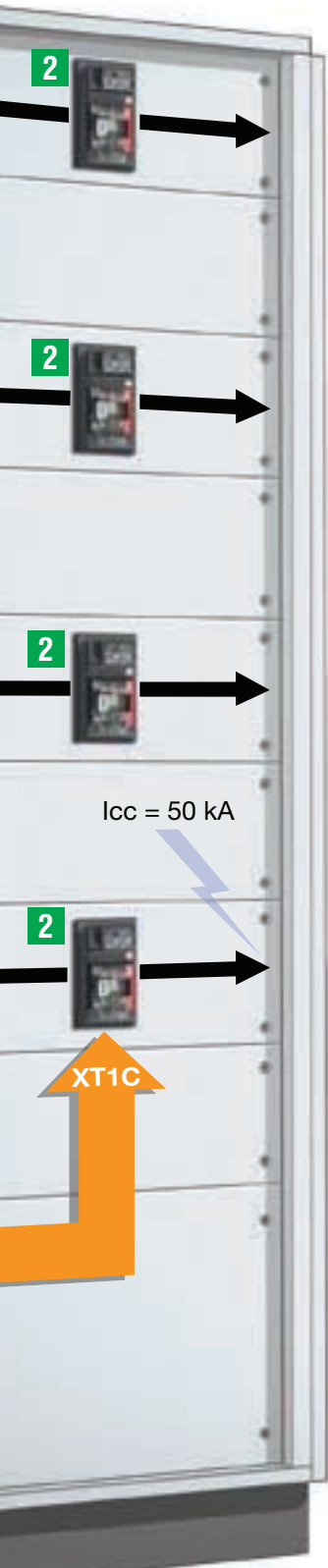

Tmax moulded-case circuit-breakers are the ideal solution for all distribution levels, from the main low voltage switchboard to the subswitchboards in the installation. They feature high peak current and specific let-through energy-limiting characteristics that allow the circuits and equipment on the load side to be sized in an optimum way.

The SACE Tmax family of moulded-case circuit-breakers is available with:

- thermomagnetic trip units for protecting direct and alternate current networks. These trip units use the physical properties of a bimetal and an electromagnet to detect the overloads and shortcircuits;
- electronic trip units for protecting alternate current networks. These trip units use microprocessor technology to obtain protection functions that make the operations extremely reliable and accurate.

Due to dedicated devices, the SACE Tmax family of moulded-case circuit-breakers allows the insulation state of the installation to be monitored and ensures that people are protected against direct and indirect contacts, in accordance with the reference standards.

Selectivity and back-up

Selective coordination can be used among various protection devices in an installation when it is necessary to minimize the problems associated with faults and abnormal service conditions.

If selective coordination is not a requirement, back-up protection can be used. This method implies that the supply side device provides protection during a short-circuit, allowing the use of a lower breaking capacity device on the load side.

Selectivity

As can be seen from the selectivity tables, there is total selectivity (T), equal to 50 A, between a Tmax XT4S TM and T5S EL.

Advantages:

- Continuity of service
- Rapid identification of the fault zone

				Sup. side			T5
Version		Relay					EL
		Model		400	400	630	
Load side		I _n [A]		320	400	630	
XT4	S	TM	250	200	T	T	T
				225	T	T	T
				250	T	T	T

Back-up

- As can be seen from the back-up tables, the back-up value between a Tmax XT1C and a T5S is 50 kA.

Advantages

- Financial savings

				Supply side	XT1	XT2	XT3	XT4	T5	T6	T7
Version		I _{cu} [kA]		TM		S					
XT1		25		50		50					
	C								50	50	40

Circuit-breakers for distribution

Trip unit	Frame [A]									
	160	250	400	500	630	800	1000	1600	2500	3200
TMD (Adjustable Thermal, Fixed Magnetic)	Tmax XT1-XT3									
TMA (Adjustable Thermal, Adjustable Magnetic)	Tmax XT2-XT4-T5-T6									
	Tmax XT2-XT4-T4-T5-T6-T7-T8									
Residual Current Devices	Frame [A]									
	160	250	400	500	630	800	1000	1600	2500	3200
RC Instantaneous	Tmax XT1-XT3									
RC Selective	Tmax XT2-XT4-T4-T5									
Integrated RC Protection in release	Tmax T7-T8									
RC on outside of switchboard (RCQ)	Tmax XT1-XT2-XT4-T4-T5-T6-T7-T8									

Power breakers

Solutions for energy measurement and communication

1 - XT4 250 Ekip E-LSIG 3p - Ekip Com, MOE-E

Due to its integrated current and voltage sensors, the Ekip E electronic trip unit can measure both the main electrical quantities and the most advanced Power quality indicators; such as Power Factor, Harmonic distortion and THD.

By means of the trip unit and Ekip Com Communication module, the MOE-E motor operator allows the digital signals from the supervision and control system to be used and converted into power signals for operating the circuit-breaker in the remote mode.



2 - T5 400 PR223DS 3p - MOE-E, VM210

Due to the conventional L, S, I and G protection functions, the PR223DS trip unit also allows the main electrical quantities to be measured. Using the VM210 accessory and without the need for voltage transformers, the user can obtain both the current values and the voltage, power and energy values in the local and remote modes via a supervising and control system.



3 - T7M 1600 PR332/P 3p - PR330/V, PR330/D-M

The SACE PR332 trip unit for Tmax T7 provides a sophisticated and flexible protection system. Fitted with the PR330/D-M internal dialogue module, PR332/P becomes a smart protection, measuring and communication device based on the Modbus® RTU protocol. Module PR330/V measures and processes the neutral and phase voltages, then transfers these data to the protection release so that a set of protection and measuring functions can be implemented.



4 - HMI030

This device, which can be installed on the front of the switchboard, comprises a graphic display showing all the measurements and alarms/events of the trip unit. Thanks to its high-level accuracy, the device is a valid substitute for conventional multimeters without the need for current/voltage transformers.



5 - XT2 160 Ekip LSIG 3p - Ekip Com, Ekip Display

Ekip Display is a unit that can be applied to the front of the advanced electronic trip unit and shows the current values, voltage values, alarms and programmed protection and communication parameter settings.





A low voltage electrical installation is similar to an industrial process for electricity distribution and needs a supervisory and monitoring system that is able to increase reliability and optimize management.

To achieve integration between conventional plant engineering techniques and control systems for the purpose of running, controlling and monitoring civil and industrial installations in a centralized and automatic way, one can consider the electrical installation as being affected by two flows:

- a main flow (energy flow) formed by the power and energy supplied to the users and loads of an installation through the line conductors and control and protection devices;
- an information flow (digital flow) formed by all the information, data and commands required to control and manage the installation.

The supervisory system handles the flow of information that transits through the communication network.

Circuit-breakers for energy measurement and communication

Trip unit	Frame [A]									
	160	250	400	500	630	800	1000	1600	2500	3200
LSI (Advanced electronic trip unit)	Tmax XT2-XT4-T4-T5-T6-T7-T8									
LSIG (Advanced electronic trip unite)	Tmax XT2-XT4-T4-T5-T6-T7-T8									
Functions	Frame [A]									
	160	250	400	500	630	800	1000	1600	2500	3200
Energy measurement	Tmax XT2-XT4-T4-T5-T6-T7-T8									
Supervision and Monitoring	Tmax XT2-XT4-T4-T5-T6-T7-T8									

In this type of installation, the circuit-breaker acts as both sensor and actuator. As a sensor, it collects sensitive information and data and sends them to the supervision system. As an actuator, it executes the command received from the control device (e.g. PC or PLC). These characteristics are of particular importance since they meet the growing demands for circuit-breaker integration into latest generation networks (Smart Grid).

Modbus RTU

Converter
RS-232/RS-485



Power breakers

Automatic network generator transfer solutions

1 - ATS022

The ATS022 device monitors both the supply lines and analyzes phase, frequency imbalance and phase loss. In addition to the standard control functions, ATS022 allows you to: select the priority line, control a third circuit-breaker, integrate the device into a supervision system with Modbus communication, read and enter the parameters, display measurements and alarms using a graphic display.



2 - T7 M (CB1) and T7 M (CB2) Interlocked XT4 (CB3) for disconnection Non-priority loads (NPL)

To achieve a correct configuration, each circuit-breaker connected to the ATS must be

accessorized with:

- mechanical interlock;
- motor operator for opening and closing;
- key lock against sole manual operation for MOE motor operators;
- state (open/closed) and tripped contact signalling contact;
- connected contact (for the withdrawable circuit-breaker version).

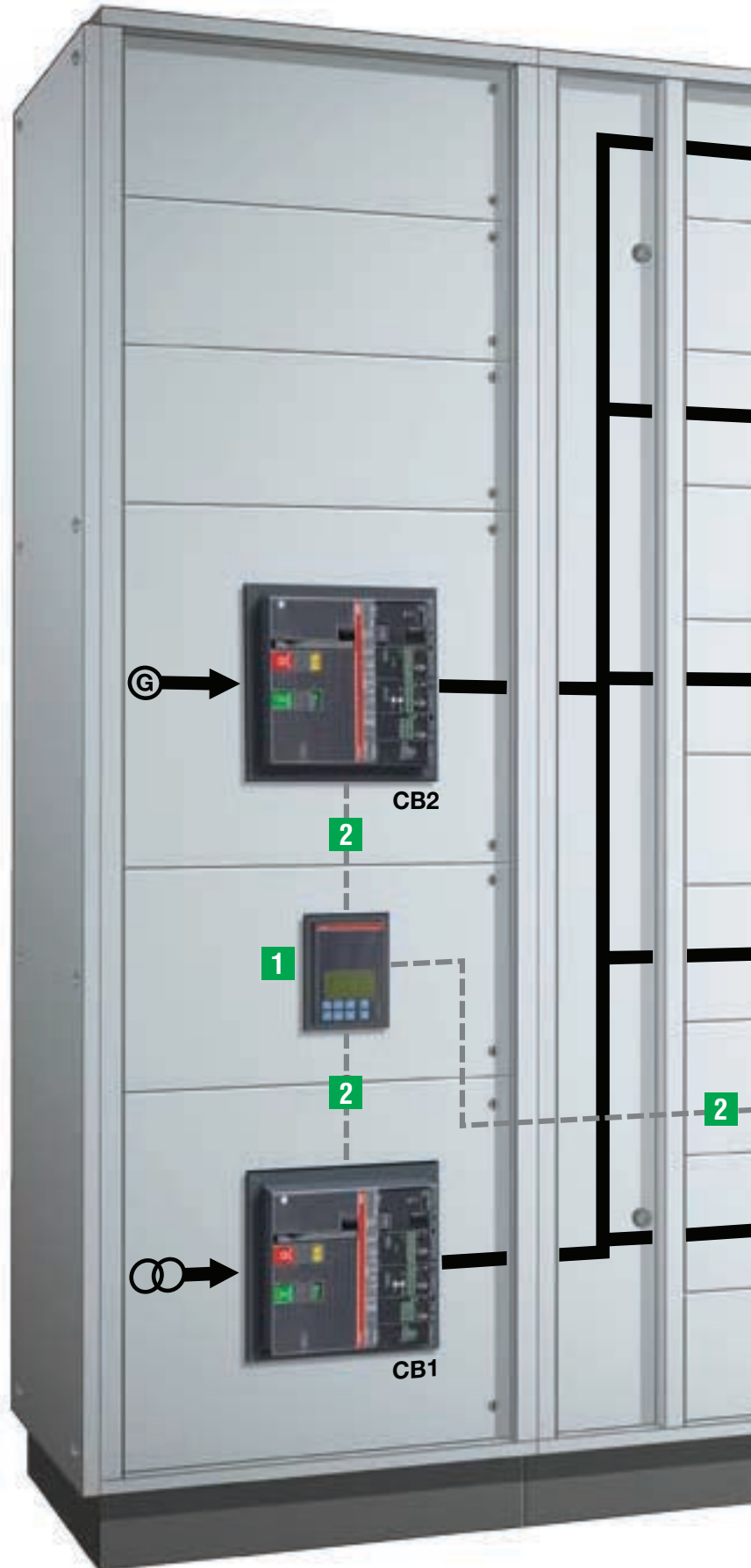
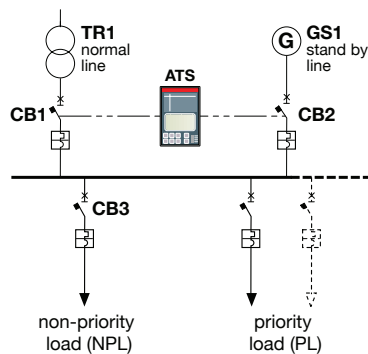



The ATS (Automatic Transfer Switch) is the network-generator transfer unit used in installations where switching the main power line to an emergency one is required in order to ensure power supply to the loads in the case of anomalies in the main line. The new generation of ATS (ATS021 and ATS022) offers the most advanced and complete solutions to guarantee service continuity. The ATS021 and ATS022 can be used both with all the circuitbreakers in the SACE Tmax XT family and with the switch-disconnectors. Reliable, safe and smart, the new ATS family conforms to international standards, is easy to configure and is suitable for all applications.

Fully coordinated systems are ensured, since ATS integrates perfectly with the entire range of ABB circuit-breakers and switch-disconnectors.

Multi-function logic meets all requirements:

- standard switching logic that allows normal and emergency lines to be monitored, commands to be transmitted to the generator and verification that the circuit-breakers have been switched (ATS021, ATS022);
- control of the two lines, both of which are non-priority (ATS021, ATS022);
- control of a third, bus-tie breaker (ATS022);
- non-priority load disconnection management (ATS022).

PL1

PL2

PL3

PL4

NPL

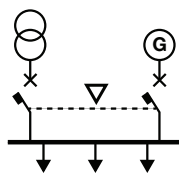

LINE-GENERATOR

If the main network is lost, the ATS021 and ATS022 devices switch to the emergency line equipped with a GenSet.

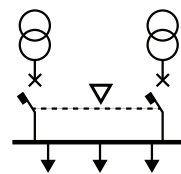

LINE-LINE

If the main network is lost, the ATS021 and ATS022 devices switch to a second line used as a standby. Selection of the priority line from the two available lines is allowed by ATS022.

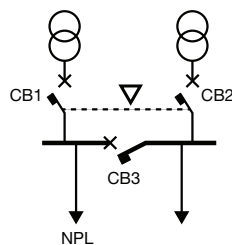

NON-PRIORITY LOAD CONTROL USING A BUS-TIE

If the main network is lost, the ATS022 device switches to a second line used as a standby by disconnecting non-priority loads (NPL) via a bus-tie.

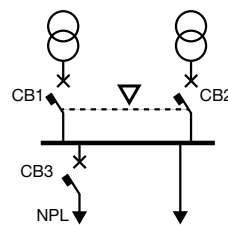

NON-PRIORITY LOAD CONTROL ON THE OUTGOING LINE

If the main network is lost, the ATS022 device switches to a second line used as a standby by disconnecting non-priority loads (NPL) branched from the main busbar.

used
cting
a a

Power breakers

Motor protection solutions

1 - T8 2000A 3 poles with PR332 LSIG

General circuit-breaker used for protecting the load side circuit-breakers dedicated to motor protection.



2 - T8 800A 3 poles with PR221-1

Circuit-breaker used for motor protection in conjunction with a thermal relay and a contactor. Instantaneous short-circuit protection (I) can be adjusted from 1 to 10xIn.



3 - XT4 250A 3 poles with Ekip M-LRIU

Circuit-breaker used for integrated motor protection.

Ekip M-LRIU is fitted with the following protections:

- against overload (L): thr eshold adjustable from 0.4...1xIn. The tripping time is established by choosing the tripping class defined by standard IEC 60947-4-1.
- rotor locking (R): with thr eshold adjustable in OFF or from 3...9x I1, with adjustable tripping time;
- against instantaneous short-circuit (I): with thr eshold adjustable from 6...13xIn and instantaneous tripping time;
- against phase imbalance (U): with thr eshold adjustable in ON or OFF.



4 - XT2 160A 3 poles with MA

Circuit-breaker used for motor protection in conjunction with a thermal relay and a contactor. Instantaneous short-circuit protection (I) can be adjusted from 6...14xIn.



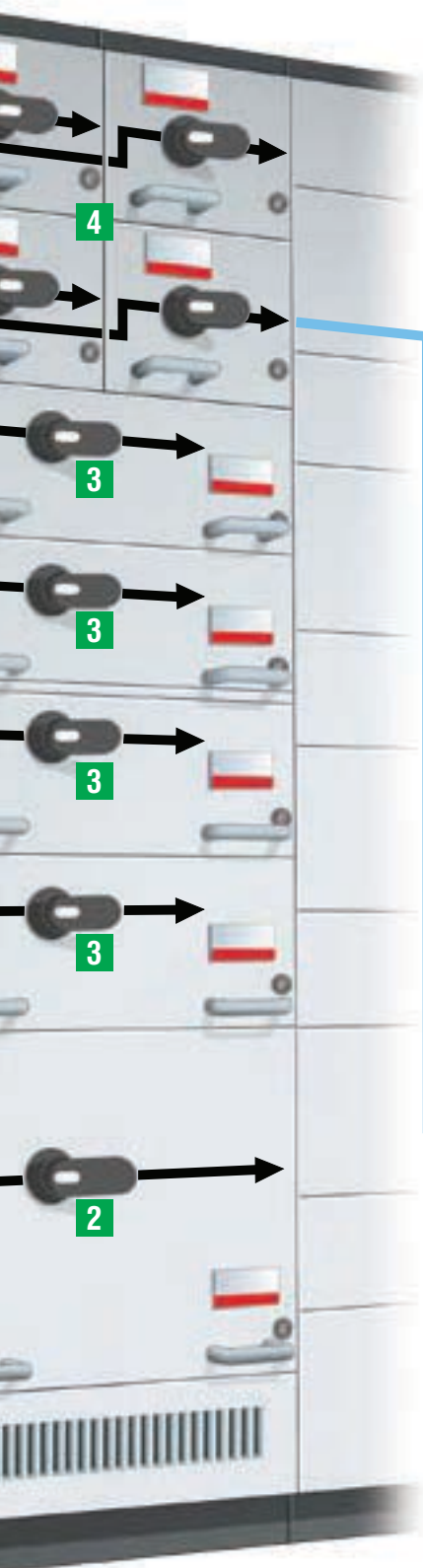

Start-up is a particularly critical phase for the motor itself and for the installation powering it. Even rated service needs to be adequately monitored and protected in order to respond to any faults that might occur. When it comes to direct starting, ABB SACE proposes two different solutions:

- a conventional system with three poles circuit-breaker equipped with a magnetic only trip unit for protection against short-circuits, a thermal relay for protection against overloads and phase failure or imbalance, and a contactor to operate the motor;
- an advanced protection system which integrates all the protection and monitoring functions, and a contactor for operating the motor, in the circuit-breaker itself.

Circuit-breakers for motor protection

Releases	Frame [A]							
	160	250	400	500	630	800	1000	1600
MF-MA (Magnetic only trip unit)	Tmax XT2-XT3-XT4							
I (Basic Magnetic only trip unit)	Tmax XT2-XT4-T5-T6-T7-T8							
LIU (Advanced Magnetic only trip unit)	Tmax XT2-XT4							
LRIU (Advanced Magnetic only trip unit)	Tmax XT2-XT4-T5-T6							

3 - 200A motor start-up unit

Protection and operation are guaranteed by circuitbreaker XT4 Ekip M-LRIU In200A 3p in conjunction with the contactor.



4 - 20A motor start-up unit

Protection and operation are guaranteed by circuit breaker XT2 MA In20A 3p in conjunction with the thermal relay and contactor.

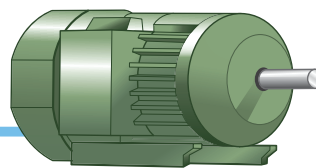

Coordination tables

Suitable devices for protection and motor operation can be identified, given the type of starting, the electrical characteristics of the installation and the characteristics of the motor.

Motor		MCCB		Contactor		Thermal relay		
Rated power	Rated current	Type	Magnetic protection setting	Type	Type	Setting range		
Pe	Ie		[A]			min [A]	max [A]	I max [A]
5.50	11.50	XT2S 160 MF 12.5	175	AF38	EF19-18.9	5.70	18.90	12.50
7.50	15.50	XT2S 160 MF 20	240	AF38	EF19-18.9	5.70	18.90	18.90
9.00	18.60	XT2S 160 MF 20	280	A50	EF45-30	9	30	30
11.00	22.00	XT2S 160 MF 32	320	A50	EF45-30	9	30	30

Power breakers

XT construction characteristics

		XT1					
Size ^(G2.1)		[A]	160				
Poles		[No.]	3, 4				
Rated service voltage, U_e ^(G2.4)	(AC) 50-60Hz	[V]	690				
	(DC)	[V]	500				
Rated insulation voltage, U_j ^(G2.5)		[V]	800				
Rated impulse withstand voltage, U_{imp} ^(G2.6)		[kV]	8				
Versions			Fixed, Plug-in ⁽²⁾				
Breaking capacities according to IEC 60947-2			B	C	N	S	H
Rated ultimate short-circuit breaking capacity, I_{cu} ^(G2.7)							
I_{cu} @ 220-230-240V 50-60Hz (AC)		[kA]	25	40	65	85	100
I_{cu} @ 380V 50-60Hz (AC)		[kA]	18	25	36	50	70
I_{cu} @ 415V 50-60Hz (AC)		[kA]	18	25	36	50	70
I_{cu} @ 440V 50-60Hz (AC)		[kA]	15	25	36	50	65
I_{cu} @ 500V 50-60Hz (AC)		[kA]	8	18	30	36	50
I_{cu} @ 525V 50-60Hz (AC)		[kA]	6	8	22	35	35
I_{cu} @ 690V 50-60Hz (AC)		[kA]	3	4	6	8	10
I_{cu} @ 250V (DC) 2 poles in series		[kA]	18	25	36	50	70
I_{cu} @ 500V (DC) 2 poles in series		[kA]	–	–	–	–	–
I_{cu} @ 500V (DC) 3 poles in series ⁽³⁾		[kA]	18	25	36	50	70
Rated service short-circuit breaking capacity, I_{cs} ^(G2.8)							
I_{cs} @ 220-230-240V 50-60Hz (AC)		[kA]	100%	100%	75% (50)	75%	75%
I_{cs} @ 380V 50-60Hz (AC)		[kA]	100%	100%	100%	100%	75%
I_{cs} @ 415V 50-60Hz (AC)		[kA]	100%	100%	100%	75%	50% (37.5)
I_{cs} @ 440V 50-60Hz (AC)		[kA]	75%	50%	50%	50%	50%
I_{cs} @ 500V 50-60Hz (AC)		[kA]	100%	50%	50%	50%	50%
I_{cs} @ 525V 50-60Hz (AC)		[kA]	100%	100%	50%	50%	50%
I_{cs} @ 690V 50-60Hz (AC)		[kA]	100%	100%	75%	50%	50%
I_{cs} @ 250V (DC) 2 poles in series		[kA]	100%	100%	100%	100%	75%
I_{cs} @ 500V (DC) 2 poles in series		[kA]	–	–	–	–	–
I_{cs} @ 500V (DC) 3 poles in series ⁽³⁾		[kA]	100%	100%	100%	100%	75%
Rated short-circuit making capacity, I_{cm} ^(G2.10)							
I_{cm} @ 220-230-240V 50-60Hz (AC)		[kA]	52.5	84	143	187	220
I_{cm} @ 380V 50-60Hz (AC)		[kA]	36	52.5	75.6	105	154
I_{cm} @ 415V 50-60Hz (AC)		[kA]	36	52.5	75.6	105	154
I_{cm} @ 440V 50-60Hz (AC)		[kA]	30	52.5	75.6	105	143
I_{cm} @ 500V 50-60Hz (AC)		[kA]	13.6	36	63	75.6	105
I_{cm} @ 525V 50-60Hz (AC)		[kA]	9.18	13.6	46.2	73.5	73.5
I_{cm} @ 690V 50-60Hz (AC)		[kA]	4.26	5.88	9.18	13.6	17
Breaking capacities according to NEMA-AB1							
@ 240V 50-60Hz (AC)		[kA]	25	40	65	85	100
@ 480V 50-60Hz (AC)		[kA]	8	18	30	36	65
Utilisation Category (IEC 60947-2)			A				
Reference Standard			IEC 60947-2				
Isolation behaviour			✓				
Mounted on DIN rail			DIN EN 50022				
Mechanical life ^(G2.14)		[No. Operations]	25000				
		[No. Hourly operations]	240				
Electrical life @ 415 V (AC) ^(G2.13)		[No. Operations]	8000				
		[No. Hourly operations]	120				
Dimensions - Fixed		3 poles	[mm]	76.2 x 70 x 130			
(Width x Depth x Height)		4 poles	[mm]	101.6 x 70 x 130			
Total opening time							
	Circuit-breaker with shunt opening release	[ms]	15				
	Circuit-breaker with undervoltage release	[ms]	15				
Trip units for power distribution							
	TMD/TMA						
	TMD					■	
	Ekip LS/I						
	Ekip I						
	Ekip LSI						
	Ekip LSIG						
	Ekip E						
Trip units for motor protection							
	MF/MA						
	Ekip M-I						
	Ekip M-LIU						
	Ekip M-LRIU						
Trip units for generator protection							
	TMG						
	Ekip G-LS/I						
Trip units for oversized Neutral Protection							
	Ekip N-LS/I						
Interchangeable protection trip units							
Weight Fixed	3/4 poles	[kg]	1.1 / 1.4				
	Plug in (EF terminals)	[kg]	2.21 / 2.82				
	Withdrawable (EF terminals)	[kg]					

⁽¹⁾ 90kA@690V only for XT4 160. Available shortly, please ask ABB SACE

⁽²⁾ XT1 plug-in I_n max=125A

⁽³⁾ XT1 500V DC 4 poles in series

⁽⁴⁾ XT4 750V DC please ask ABB SACE for availability

■ Complete circuit-breaker

▲ Loose trip unit

XT2						XT3		XT4				
160						250		160 / 250				
3, 4						3, 4		3, 4				
690						690		690				
500						500		500 ⁽⁴⁾				
1000						800		1000				
8						8		8				
Fixed, Withdrawable, Plug-in						Fixed, Plug-in		Fixed, Withdrawable, Plug-in				
N	S	H	L	V		N	S	N	S	H	L	V
65	85	100	150	200		50	85	65	85	100	150	200
36	50	70	120	150		36	50	36	50	70	120	150
36	50	70	120	150		36	50	36	50	70	120	150
36	50	65	100	150		25	40	36	50	65	100	150
30	36	50	60	70		20	30	30	36	50	60	70
20	25	30	36	50		13	20	20	25	45	50	50
10	12	15	18	20		5	6	10	12	15	20	25 (90 ⁽¹⁾)
36	50	70	85	100		36	50	36	50	70	85	100
-	-	-	-	-		-	-	36	50	70	85	100
36	50	70	85	100		36	50	36	50	70	85	100
100%	100%	100%	100%	100%		75%	50%	100%	100%	100%	100%	100%
100%	100%	100%	100%	100%		75%	50% (27)	100%	100%	100%	100%	100%
100%	100%	100%	100%	100%		75%	50% (27)	100%	100%	100%	100%	100%
100%	100%	100%	100%	100%		75%	50%	100%	100%	100%	100%	100%
100%	100%	100%	100%	100%		75%	50%	100%	100%	100%	100%	100%
100%	100%	100%	100%	100%		75%	50%	100%	100%	100%	100%	100%
100%	100%	100%	100%	75%		75%	50%	100%	100%	100%	100%	75% (20)
100%	100%	100%	100%	100%		100%	75%	100%	100%	100%	100%	100%
-	-	-	-	-		-	-	100%	100%	100%	100%	100%
100%	100%	100%	100%	100%		100%	75%	100%	100%	100%	100%	100%
143	187	220	330	440		105	187	143	187	220	330	440
75.6	105	154	264	330		75.6	105	75.6	105	154	264	330
75.6	105	154	264	330		75.6	105	75.6	105	154	264	330
75.6	105	143	220	330		52.5	84	75.6	105	143	220	330
63	75.6	105	132	154		40	63	63	75.6	105	132	154
40	52.5	63	75.6	105		26	40	40	52.5	94.5	105	105
17	24	30	36	40		7.65	13.6	17	24	30	40	52.5
65	85	100	150	200		50	85	65	85	100	150	200
30	36	65	100	150		25	35	30	36	65	100	150
A IEC 60947-2						A IEC 60947-2		A IEC 60947-2				
DIN EN 50022						DIN EN 50022		DIN EN 50022				
25000						25000		25000				
240						240		240				
8000						8000		8000				
120						120		120				
90 x 82.5 x 130						105 x 70 x 150		105 x 82.5 x 160				
120 x 82.5 x 130						140 x 70 x 150		140 x 82.5 x 160				
15						15		15				
15						15		15				
■						■		■				
■						■		■				
■						■		■				
■						■		■				
■						■		■				
■						■		■				
▲						▲		▲				
▲						▲		▲				
▲						▲		▲				
▲						▲		▲				
▲						▲		▲				
▲						▲		▲				
▲						▲		▲				
1.2 / 1.6						1.7 / 2.1		2.5 / 3.5				
2.54 / 3.27						3.24 / 4.1		4.19 / 5.52				
3.32 / 4.04								5 / 6.76				

Power distribution MCCBs

Tmax release characteristics

Residual current releases		RC221	RC222		RC223
Sizes		T1-T2-T3	T1-T2-T3	T4 and T5	T3 and T4
	Version	3/4 Poles F	3/4 Poles-F, P, W-	4 Poles-F, P, W -	T3 4 Poles F, T4 250 4 Poles-F,P,W -
	Type	shape "L"	shape "L"	Underneath	Underneath
	Technology	With microprocessor	With microprocessor	With microprocessor	With microprocessor
	Action	Solenoid	Solenoid	Solenoid	Solenoid
	Primary operating voltage [V]	85...500	85...500	85...500	110...500
	Frequency of operation [Hz]	45...66	45...66	45...66	45...66
	Self-supply	•	•	•	•
	Field of test operation [V]	85...500	85...500	85...500	110...500
	Rated service current [A]	up to 250 A	up to 250 A	up to 500 A	up to 500 A
	Adjustable trip thresholds [A]	0.03-0.1-0.3-0.5-1-3	0.03- 0.05-0.1-0.3-0.5-1-3-5 -10	0.03- 0.05-0.1-0.3-0.5-1-3-5 -10	0.003-0.05-0.1-0.3-0.5-1
	Adjustable trip times [s]	instantaneous	instantaneous 0.1- 0.2- 0.3- 0.5- -2- 3	instantaneous 0.1- 0.2- 0.3- 0.5- -2- 3	instantaneous 0.1- 0.2- 0.3- 0.5- -2- 3
	Tolerance over trip times		± 20%	± 20%	± 20%
	Absorbed power	< 8 W at 400 V AC	< 10 W at 400 V AC	< 10 W at 400 V AC	< 10 W at 400 V AC
	Local trip indication	•	•	•	•
	OS with changeover contact for trip signalling	•	•	•	•
	Input for remote opening	-	•	•	•
	NO contact for signalling pre-alarm	-	•	•	•
	NO contact for signalling alarm	-	•	•	•
	Indication of pre-alarm from 25% IΔn (tolerance ± 3%)	-	•	•	•
	Indication of alarm timing at 75% IΔn (tolerance ± 3%)	-	•	•	•
	Type A for pulsating alternating current, AC direct current	•	•	•	•
	Type AE with remote release	-	•	•	•
	Type B for pulsating current and direct current	-	-	-	•
	Type S selective	-	•	•	•
	Button for insulation test	•	•	•	•
	Power supply from the top and bottom	•	•	•	•
	Assembly with three-pole circuit-breakers	•	•	-	-
	Assembly with four-pole circuit-breakers	•	•	•	•
	Conversion Kit of cb with residual current from fixed to plug-in	-	•	•	•

RCQ			
	Characteristics		All 3/4 poles
	Power supply voltage AC [V]/DC [V]	80...500/48...125	
	Frequency of operation [Hz]	45...66	
	Inrush power consumption	100 [VA]/100 [W]	
	Service power consumption	6 [VA]/6 [W]	
	Adjustment of trip threshold		
	1st range of Adjustments [A]	0.03-0.05-0.1-0.3-0.5	
	2nd range of Adjustments [A]	1- 3-5-10-30	
	Adjustment of trip times IΔn [s]	instantaneous-0.1-0.2-0.3-0.5-0.7-1-2-3-5	
	Adjustment of pre-alarm threshold [%] x IΔn	25...75% x IΔn	
	Range of use of closed transformers		
	Toroidal transformer Ø 60 [mm]	[A] 0.03...30	
	Toroidal transformer Ø 110 [mm]	[A] 0.03...30	
	Toroidal transformer Ø 185 [mm]	[A] 0.1...30	
	Range of use of openable transformers		
	Toroidal transformer Ø 60 [mm]	[A] 0.03...30	
	Toroidal transformer Ø 110 [mm]	[A] 0.03...30	
	Toroidal transformer Ø 185 [mm]	[A] 0.1...30	
	Pre-threshold pre-alarm indication		Yellow flashing LED 1 changeover contact N.O. 6A-250 V AC 50/60 Hz
	Signalling of residual relay trip		Magnetic indication and two changeover contacts (N.O. N.C. ; N.O.). 6A-250 V AC 50/60 Hz
	Remote opening control		N.O. contact Trip time 15 ms
	Connection to the toroidal transformer		By means of 4 twisted conductors. Maximum length: 5 m
	Dimensions L x H x D [mm]	96 x 96 x 131.5	
	Drilling for assembly on door [mm]	92 x 92	
	Degree of protection on the front	IP41	
	Degree of protection on the rear	IP30	

PR330/D-M



PR330/D-M

The PR330/D-M communication module is the solution for connecting the ABB moulded-case circuit-breakers to a Modbus network, for supervision and remote control of the circuit-breaker

PR021/K



PR021/K

The SACE PR021/K is able to convert the digital signals provided by the PR222DS/PD, PR223DS, PR223EF, PR331, PR332, PR333 protection units into electric signals by means of normally open electrical contacts, and allow remote signalling of alarms and release trips.

VM210



HM1030



Can be used with all the protection releases fitted with dialogue, is designed to be installed on the front of the panel. It consists of a graphic display where all the measurements and alarms/events of the release are displayed. Thanks to its high precision, the device can replace traditional multi-meters without the need of current/voltage transformers. The HMI030 is connected directly to the protection release by means of a serial line and requires a 24 V DC power supply.

PR330/V



PR330/V

The internal PR330/V module can be added to the trip unit and allow the phase and neutral voltages to be measured and processed, transferring these data to the protection release itself, so that a series of protection functions and measurements can be implemented.

BT030



BT030

The BT030 is an device to be connected to the Test connector of PR222DS, PR223DS, PR223EF, PR232/P, PR331/Pand PR332/P. It allows Bluetooth communication between the protection release and a hand-held PC or a laptop with a Bluetooth port. T

PR010/T



The unit SACE PR010/T is an instrument able to carry out the Test, programming and parameter reading functions for the protection units which equip the circuit-breakers. For T4, T5, T6 and T7, the test, programming and parameter reading functions are available. It is possible to store the results of primary interest regarding the tests inside the unit itself and to send them to the PC. In both automatic and manual mode, the SACE PR010/T unit is able to test: – protection functions L, S, I, G – protection functions L, R, I, U (for PR222MP) – monitoring of correct operation of the microprocessor.



Ratings @ 400V

	Icu	Ics
XT1C	25kA	100%
XT1N	36kA	75%
XT1S	50kA	75%

Protection types available

Type	Settings	
	Ith	Im
Standard Distribution (3&4 pole)	70-100%	

Fixed Pattern Circuit Breaker

Supplied as standard with front bar terminals for busbar - for other terminals see accessories section

Model	Ith/In	Current [A]		Product Hierarchy 3000009 Order Code	
		I3		3 Pole	4 Pole
XT1C	XT1C160R25	450A		1SDA067391R1	1SDA067400R1
	XT1C160R32	450A		1SDA067392R1	1SDA067401R1
	XT1C160R40	450A		1SDA067393R1	1SDA067402R1
	XT1C160R50	500A		1SDA067394R1	1SDA067403R1
	XT1C160R63	630A		1SDA067395R1	1SDA067404R1
	XT1C160R80	800A		1SDA067396R1	1SDA067405R1
	XT1C160R100	1000A		1SDA067397R1	1SDA067410R1
	XT1C160R125	1250A		1SDA067398R1	1SDA067409R1
XT1C160R160	1600A		1SDA067399R1	1SDA067641R1	
XT1N	XT1N160R32	450A		1SDA067411R1	1SDA067419R1
	XT1N160R40	450A		1SDA067412R1	1SDA067647R1
	XT1N160R50	500A		1SDA067413R1	1SDA067421R1
	XT1N160R63	630A		1SDA067414R1	1SDA067422R1
	XT1N160R80	800A		1SDA067415R1	1SDA067423R1
	XT1N160R100	1000A		1SDA067416R1	1SDA067424R1
	XT1N160R125	1250A		1SDA067417R1	1SDA067427R1
	XT1N160R160	1600A		1SDA067418R1	1SDA067428R1
XT1S	XT1S160R50	500A		1SDA067431R1	1SDA067439R1
	XT1S160R63	630A		1SDA067432R1	1SDA067440R1
	XT1S160R80	800A		1SDA067433R1	1SDA067441R1
	XT1S160R100	1000A		1SDA067434R1	1SDA067442R1
	XT1S160R125	1250A		1SDA067435R1	1SDA067445R1
	XT1S160R160	1600A		1SDA067436R1	1SDA067446R1

Power distribution MCCBs

Type Tmax XT2 - N, S, H thermomagnetic



Ratings @ 400V

	Icu	Ics
XT2N	36kA	100%
XT2S	50kA	100%
XT2H	70kA	100%

Fixed Pattern Circuit Breaker

Supplied as standard with front bar terminals for busbar - for other terminals see accessories section

Thermomagnetic TMA

Model	Ith/In	Current [A]		Product Hierarchy 300009 Order Code	
		I3		3 Pole	4 Pole
XT2N	XT2N160R32	320A		1SDA067013R1	1SDA067034R1
	XT2N160R40	400A		1SDA067014R1	1SDA067035R1
	XT2N160R50	500A		1SDA067015R1	1SDA067036R1
	XT2N160R63	630A		1SDA067016R1	1SDA067037R1
	XT2N160R80	800A		1SDA067017R1	1SDA067038R1
	XT2N160R100	1000A		1SDA067018R1	1SDA067039R1
	XT2N160R125	1250A		1SDA067019R1	1SDA067042R1
	XT2N160R160	1600A		1SDA067020R1	1SDA067043R1
XT2S	XT2S160R32	320A		1SDA067553R1	1SDA067574R1
	XT2S160R40	400A		1SDA067554R1	1SDA067575R1
	XT2S160R50	500A		1SDA067555R1	1SDA067576R1
	XT2S160R63	630A		1SDA067556R1	1SDA067577R1
	XT2S160R80	800A		1SDA067557R1	1SDA067578R1
	XT2S160R100	1000A		1SDA067558R1	1SDA067579R1
	XT2S160R125	1250A		1SDA067559R1	1SDA067582R1
	XT2S160R160	1600A		1SDA067560R1	1SDA067583R1
XT2H	XT2H160R32	320A		1SDA067597R1	1SDA067618R1
	XT2H160R40	400A		1SDA067598R1	1SDA067619R1
	XT2H160R50	500A		1SDA067599R1	1SDA067620R1
	XT2H160R63	630A		1SDA067600R1	1SDA067621R1
	XT2H160R80	800A		1SDA067601R1	1SDA067622R1
	XT2H160R100	1000A		1SDA067602R1	1SDA067623R1
	XT2H160R125	1250A		1SDA067603R1	1SDA067626R1
	XT2H160R160	1600A		1SDA067604R1	1SDA067627R1

Power distribution MCCBs

Type Tmax XT3 - N, S thermomagnetic & magnetic only



Ratings @ 400V

	Icu	Ics
XT3N	36kA	100%
XT3S	50kA	100%
XT3H	70kA	100%

Fixed Pattern Circuit Breaker

Supplied as standard with front bar terminals for busbar - for other terminals see accessories section

Thermomagnetic TMA Model	Ith/In	Current [A] I3	Product Hierarchy 3000009 Order Code	
			3 Pole	4 Pole
XT3N	XT3N160R63	630A	1SDA068053R1	1SDA068060R1
	XT3N160R80	800A	1SDA068054R1	1SDA068061R1
	XT3N160R100	1000A	1SDA068055R1	1SDA068062R1
	XT3N160R125	1250A	1SDA068056R1	1SDA068067R1
	XT3N160R160	1600A	1SDA068057R1	1SDA068068R1
	XT3N160R200	2000A	1SDA068058R1	1SDA068069R1
	XT3N160R250	2500A	1SDA068059R1	1SDA068070R1
XT3S	XT3S160R63	630A	1SDA068215R1	1SDA068222R1
	XT3S160R80	800A	1SDA068216R1	1SDA068223R1
	XT3S160R100	1000A	1SDA068217R1	1SDA068224R1
	XT3S160R125	1250A	1SDA068221R1	1SDA068229R1
	XT3S160R160	1600A	1SDA068219R1	1SDA068230R1
	XT3S160R200	2000A	1SDA068220R1	1SDA068231R1
	XT3S160R250	2500A	1SDA068221R1	1SDA068232R1

Electronic Release Model	Type	In	Product Hierarchy 3000006 Order Code	
			3 Pole	4 Pole
XT2N	XT2N160 Ekip LS/I	63A	1SDA067056R1	1SDA067092R1
	XT2N160 Ekip LS/I	100A	1SDA067057R1	1SDA067093R1
	XT2N160 Ekip LS/I	160A	1SDA067058R1	1SDA067095R1
XT2S	XT2S160 Ekip LS/I	63A	1SDA067802R1	1SDA067835R1
	XT2S160 Ekip LS/I	100A	1SDA067803R1	1SDA067836R1
	XT2S160 Ekip LS/I	160A	1SDA067804R1	1SDA067838R1
XT2H	XT2H160 Ekip LS/I	63A	1SDA067859R1	1SDA067892R1
	XT2H160 Ekip LS/I	100A	1SDA067860R1	1SDA067893R1
	XT2H160 Ekip LS/I	160A	1SDA067861R1	1SDA067895R1

Power distribution MCCBs

Type Tmax XT4 - N, S, H thermomagnetic & magnetic only



Ratings @ 400V

	Icu	Ics
XT4N	36kA	100%
XT4S	50kA	100%
XT4H	70kA	100%

Fixed Pattern Circuit Breaker

Supplied as standard with front bar terminals for busbar - for other terminals see accessories section

Thermomagnetic TMA Magnetic Only TMD

Model	Ith/In	Current [A]		Product Hierarchy 3000009 Order Code	
		I3	%N	3 Pole	4 Pole
XT4N TMD	XT4N160R20	300A	100	1SDA068080R1	1SDA068094R1
	XT4N160R32	320A	100	1SDA068082R1	1SDA068096R1
XT4N TMA	XT4N160R50	500A	100	1SDA068084R1	1SDA068098R1
	XT4N160R80	800A	100	1SDA068086R1	1SDA068100R1
	XT4N160R100	1000A	100	1SDA068087R1	1SDA068101R1
	XT4N160R125	1250A	100	1SDA068088R1	1SDA068107R1
	XT4N160R160	1600A	100	1SDA068089R1	1SDA068108R1
	XT4N250R200	2000A	100	1SDA068090R1	1SDA068109R1
	XT4N250R250	2500A	100	1SDA068092R1	1SDA068111R1
XT4S TMD	XT4S160R20	300A	100	1SDA068300R1	1SDA068314R1
	XT4S160R32	320A	100	1SDA068302R1	1SDA068316R1
XT4S TMA	XT4S160R50	500A	100	1SDA068304R1	1SDA068318R1
	XT4S160R80	800A	100	1SDA068306R1	1SDA068320R1
	XT4S160R100	1000A	100	1SDA068307R1	1SDA068321R1
	XT4S160R125	1250A	100	1SDA068308R1	1SDA068327R1
	XT4S160R160	1600A	100	1SDA068309R1	1SDA068328R1
	XT4S250R200	2000A	100	1SDA068310R1	1SDA068329R1
	XT4S250R250	2500A	100	1SDA068312R1	1SDA068331R1
XT4H TMD	XT4H160R20	300A	100	1SDA068333R1	1SDA068347R1
	XT4H160R32	320A	100	1SDA068335R1	1SDA068349R1
XT4H TMA	XT4H160R50	500A	100	1SDA068337R1	1SDA068351R1
	XT4H160R80	800A	100	1SDA068339R1	1SDA068353R1
	XT4H160R100	1000A	100	1SDA068340R1	1SDA068354R1
	XT4H160R125	1250A	100	1SDA068341R1	1SDA068360R1
	XT4H160R160	1600A	100	1SDA068342R1	1SDA068361R1
	XT4H250R200	2000A	100	1SDA068343R1	1SDA068362R1
	XT4H250R250	2500A	100	1SDA068345R1	1SDA068364R1

Power distribution MCCBs

Type Tmax XT4 - N, S, H electronic releases



Ratings @ 400V

	Icu	Ics
XT4N	36kA	100%
XT4S	50kA	100%
XT4H	70kA	100%

Fixed Pattern Circuit Breaker

Supplied as standard with front bar terminals for busbar - for other terminals see accessories section

Electronic Release

Model	Type	In	Product Hierarchy 3000009 Order Code	
			3 Pole	4 Pole
XT4N LS/I	XT4N160 Ekip LS/I	40A	1SDA068122R1	1SDA068142R1
	XT4N160 Ekip LS/I	63A	1SDA068123R1	1SDA068144R1
	XT4N160 Ekip LS/I	100A	1SDA068124R1	1SDA068145R1
	XT4N160 Ekip LS/I	160A	1SDA068125R1	1SDA068146R1
	XT4N250 Ekip LS/I	250A	1SDA068126R1	1SDA068147R1
XT4N LSI	XT4N160 Ekip LSI	40A	1SDA068132R1	1SDA068153R1
	XT4N160 Ekip LSI	63A	1SDA068133R1	1SDA068154R1
	XT4N160 Ekip LSI	100A	1SDA068134R1	1SDA068155R1
	XT4N160 Ekip LSI	160A	1SDA068135R1	1SDA068156R1
	XT4N250 Ekip LSI	250A	1SDA068136R1	1SDA068157R1
XT4S LS/I	XT4S160 Ekip LS/I	40A	1SDA068471R1	1SDA068491R1
	XT4S160 Ekip LS/I	63A	1SDA068472R1	1SDA068492R1
	XT4S160 Ekip LS/I	100A	1SDA068473R1	1SDA068493R1
	XT4S160 Ekip LS/I	160A	1SDA068474R1	1SDA068494R1
	XT4S160 Ekip LS/I	250A	1SDA068475R1	1SDA068495R1
XT4S LSI	XT4S160 Ekip LSI	40A	1SDA068481R1	1SDA068501R1
	XT4S160 Ekip LSI	63A	1SDA068482R1	1SDA068502R1
	XT4S160 Ekip LSI	100A	1SDA068483R1	1SDA068503R1
	XT4S160 Ekip LSI	160A	1SDA068484R1	1SDA068504R1
	XT4S160 Ekip LSI	250A	1SDA068485R1	1SDA068505R1
XT4H LS/I	XT4H160 Ekip LS/I	40A	1SDA068511R1	1SDA068531R1
	XT4H160 Ekip LS/I	63A	1SDA068512R1	1SDA068532R1
	XT4H160 Ekip LS/I	100A	1SDA068513R1	1SDA068533R1
	XT4H160 Ekip LS/I	160A	1SDA068514R1	1SDA068534R1
	XT4H250 Ekip LS/I	250A	1SDA068515R1	1SDA068535R1
XT4H LSI	XT4H160 Ekip LSI	40A	1SDA068521R1	1SDA068541R1
	XT4H160 Ekip LSI	63A	1SDA068522R1	1SDA068542R1
	XT4H160 Ekip LSI	100A	1SDA068523R1	1SDA068543R1
	XT4H160 Ekip LSI	160A	1SDA068524R1	1SDA068544R1
	XT4H250 Ekip LSI	250A	1SDA068525R1	1SDA068545R1

Product Hierarchy 3000006

T4N	T4N320 PR221DS-LS	320A	1SDA054117R1	1SDA054121R1
	T4N320 PR221DS-LSI	320A	1SDA054119R1	1SDA054123R1
T4S	T4S320 PR221DS-LS	320A	1SDA054125R1	1SDA054129R1
	T4S320 PR221DS-LSI	320A	1SDA054127R1	1SDA054131R1
T4H	T4H320 PR221DS-LS/I	320A	1SDA054133R1	1SDA054137R1
	T4H320 PR222DS-LSI	320A	1SDA054135R1	1SDA054139R1

Power distribution MCCBs

Type Tmax T5 - N, S, H thermomagnetic & electronic releases



Ratings @ 400V

	Icu	Ics
T5N	36kA	100%
T5S	50kA	100%
T5H	70kA	100%

Fixed Pattern Circuit Breaker

Supplied as standard with front bar terminals for busbar - for other terminals see accessories section

Thermomagnetic TMA

Model	Ith/In	Current [A]		Product Hierarchy 3000006 Order Code	
		I3	%N	3 Pole	4 Pole
T5N TMA	T5N400R320	3200A	100	1SDA054436R1	1SDA054477R1
	T5N400R400	4000A	100	1SDA054437R1	1SDA054478R1
	T5N630R500	5000A	100	1SDA054456R1	1SDA054487R1
T5S TMA	T5S400R320	3200A	100	1SDA054440R1	1SDA054479R1
	T5S400R400	4000A	100	1SDA054441R1	1SDA054480R1
	T5S630R500	5000A	100	1SDA054461R1	1SDA054489R1
T5H TMA	T5H400R320	3200A	100	1SDA054444R1	1SDA054481R1
	T5H400R400	4000A	100	1SDA054445R1	1SDA054482R1
	T5H630R500	5000A	100	1SDA054465R1	1SDA054491R1

Electronic Release

Model	Type	In	Product Hierarchy 3000006 Order Code	
			3 Pole	4 Pole
T5N LS/I	T5N400 PR221DS-LS/I	320A	1SDA054316R1	1SDA054324R1
	T5N400 PR221DS-LS/I	400A	1SDA054317R1	1SDA054325R1
	T5N630 PR221DS-LS/I	630A	1SDA054396R1	1SDA054400R1
T5N LSI	T5N400 PR222DS/P-LSI	320A	1SDA054320R1	1SDA054328R1
	T5N400 PR222DS/P-LSI	400A	1SDA054321R1	1SDA054329R1
	T5N630 PR222DS/P-LSI	630A	1SDA054398R1	1SDA054402R1
T5S LS/I	T5S400 PR221DS-LS/I	320A	1SDA054332R1	1SDA054340R1
	T5S400 PR221DS-LS/I	400A	1SDA054333R1	1SDA054333R1
	T5S630 PR221DS-LS/I	630A	1SDA054404R1	1SDA054408R1
T5S LSI	T5S400 PR222DS/P-LSI	320A	1SDA054336R1	1SDA054344R1
	T5S400 PR222DS/P-LSI	400A	1SDA054337R1	1SDA054345R1
	T5S630 PR222DS/P-LSI	630A	1SDA054406R1	1SDA054410R1
T5H LS/I	T5H400 PR221DS-LS/I	320A	1SDA054348R1	1SDA054356R1
	T5H400 PR221DS-LS/I	400A	1SDA054349R1	1SDA054357R1
	T5H4630 PR221DS-LS/I	630A	1SDA054412R1	1SDA054416R1
T5H LSI	T5H400 PR222DS/P-LSI	320A	1SDA054352R1	1SDA054360R1
	T5H400 PR222DS/P-LSI	400A	1SDA054353R1	1SDA054361R1
	T5H4630 PR222DS/P-LSI	630A	1SDA054414R1	1SDA054418R1

Power distribution MCCBs

Type Tmax T6 - N, S, H, L thermomagnetic electronic release



Ratings @ 400V

	Icu	Ics
T6N	36kA	100%
T6S	50kA	100%
T6H	70kA	100%

Fixed Pattern Circuit Breaker

Supplied as standard with front bar terminals for busbar - for other terminals see accessories section

Thermomagnetic TMA

Model	Ith/In	Current [A]		Product Hierarchy 3000006 Order Code	
		I3	%N	3 Pole	4 Pole
T6N TMA	T6N630R630	6300A	100	1SDA060202R1	1SDA060210R1
	T6N800R800	8000A	100	1SDA060214R1	1SDA060222R1
T6S TMA	T6S630R630	6300A	100	1SDA060204R1	1SDA060211R1
	T6S800R800	8000A	100	1SDA060216R1	1SDA060223R1
T6H TMA	T6H630R630	6300A	100	1SDA060206R1	1SDA060212R1
	T6H800R800	8000A	100	1SDA060218R1	1SDA060224R1

Electronic Release

Model	Type	In	Product Hierarchy 3000006 Order Code	
			3 Pole	4 Pole
T6N LS/I	T6N630 PR221DS-LS/I	630A	1SDA060226R1	1SDA060231R1
	T6N800 PR221DS-LS/I	800A	1SDA060268R1	1SDA060273R1
T6N P-LSI	T6N630 PR222DS/P-LSI	630A	1SDA060228R1	1SDA060233R1
	T6N800 PR222DS/P-LSI	800A	1SDA060270R1	1SDA060275R1
T6S LS/I	T6S630 PR221DS-LS/I	630A	1SDA060236R1	1SDA060243R1
	T6S800 PR221DS-LS/I	800A	1SDA060278R1	1SDA060285R1
T6S P-LSI	T6S630 PR222DS/P-LSI	630A	1SDA060238R1	1SDA060243R1
	T6S800 PR222DS/P-LSI	800A	1SDA060280R1	1SDA060285R1
T6H LS/I	T6H630 PR221DS-LS/I	630A	1SDA060246R1	1SDA060251R1
	8T6H00 PR221DS-LS/I	800A	1SDA060289R1	1SDA060294R1
T6H P-LSI	T6H630 PR222DS/P-LSI	630A	1SDA060248R1	1SDA060253R1
	T6H800 PR222DS/P-LSI	800A	1SDA060291R1	1SDA060296R1

Power distribution MCCBs

Type Tmax T7 - S electronic release



Ratings @ 400V

	Icu	Ics
T7S	50kA	100%

Fixed Pattern Circuit Breaker

Supplied as standard with front bar terminals for busbar - for other terminals see accessories section

Electronic Release

Toggle Operated

Product Hierarchy 3000006
Order Code

Model	Current [A]	In	Product Hierarchy 3000006 Order Code	
			3 Pole	4 Pole
T7S P-LS/I	T7S800 PR231/P-LS/I	800A	1SDA061963R1	1SDA061973R1
	T7S1000 PR231/P-LS/I	1000A	1SDA062738R1	1SDA062746R1
	T7S1250 PR231/P-LS/I	1250A	1SDA062866R1	1SDA062874R1
	T7S1600 PR231/P-LS/I	1600A	1SDA062994R1	1SDA063002R1
T7S P-LSI	T7S800 PR232/P-LSI	800A	1SDA061964R1	1SDA061974R1
	T7S1000 PR232/P-LSI	1000A	1SDA062739R1	1SDA062747R1
	T7S1250 PR232/P-LSI	1250A	1SDA062867R1	1SDA062867R1
	T7S1600 PR232/P-LSI	1600A	1SDA062995R1	1SDA062995R1
T7S P-LSIG	T7S800 PR331/P-LSIG	800A	1SDA061965R1	1SDA061975R1
	T7S1000 PR331/P-LSIG	1000A	1SDA062740R1	1SDA062748R1
	T7S1250 PR331/P-LSIG	1250A	1SDA062868R1	1SDA062876R1
	T7S1600 PR331/P-LSIG	1600A	1SDA062996R1	1SDA063004R1
T7S P-LSIG	T7S800 PR332/P-LSIG	800A	1SDA061968R1	1SDA061978R1
	T7S1000 PR332/P-LSIG	1000A	1SDA062743R1	1SDA062751R1
	T7S1250 PR332/P-LSIG	1250A	1SDA062871R1	1SDA062879R1
	T7S1600 PR332/P-LSIG	1600A	1SDA062999R1	1SDA063007R1

Pushbutton Operated

T7S P-LS/I	T7S800 PR231/P-LS/I	800A	1SDA061981R1	1SDA061989R1
	T7S1000 PR231/P-LS/I	1000A	1SDA062754R1	1SDA062762R1
	T7S1250 PR231/P-LS/I	1250A	1SDA062882R1	1SDA062890R1
	T7S1600 PR231/P-LS/I	1600A	1SDA063010R1	1SDA063018R1
T7S P-LSI	T7S800 PR232/P-LSI	800A	1SDA061982R1	1SDA061990R1
	T7S1000 PR232/P-LSI	1000A	1SDA062755R1	1SDA062763R1
	T7S1250 PR232/P-LSI	1250A	1SDA062883R1	1SDA062891R1
	T7S1600 PR232/P-LSI	1600A	1SDA063011R1	1SDA063019R1
T7S P-LSIG	T7S800 PR331/P-LSIG	800A	1SDA061983R1	1SDA061991R1
	T7S1000 PR331/P-LSIG	1000A	1SDA062756R1	1SDA062764R1
	T7S1250 PR331/P-LSIG	1250A	1SDA062884R1	1SDA062892R1
	T7S1600 PR331/P-LSIG	1600A	1SDA063020R1	1SDA063019R1
T7S P-LSIG	T7S800 PR332/P-LSIG	800A	1SDA061986R1	1SDA061994R1
	T7S1000 PR332/P-LSIG	1000A	1SDA062759R1	1SDA062767R1
	T7S1250 PR332/P-LSIG	1250A	1SDA062887R1	1SDA062895R1
	T7S1600 PR332/P-LSIG	1600A	1SDA063015R1	1SDA063023R1

Power distribution MCCBs

Type Tmax T7 - H electronic release



Ratings @ 400V

	Icu	Ics
T7H	70kA	100%

Fixed Pattern Circuit Breaker

Supplied as standard with front bar terminals for busbar - for other terminals see accessories section

Electronic Release

Toggle Operated

Model	Current [A]	In	Product Hierarchy 3000006 Order Code	
			3 Pole	4 Pole
T7H P-LS/I	T7H800 PR231/P-LS/I	800A	1SDA062642R1	1SDA062650R1
	T7H1000 PR231/P-LS/I	1000A	1SDA062770R1	1SDA062778R1
	T7H1250 PR231/P-LS/I	1250A	1SDA062898R1	1SDA062906R1
	T7H1600 PR231/P-LS/I	1600A	1SDA063026R1	1SDA063034R1
T7H P-LSI	T7H800 PR232/P-LSI	800A	1SDA062643R1	1SDA062651R1
	T7H1000 PR232/P-LSI	1000A	1SDA062771R1	1SDA062779R1
	T7H1250 PR232/P-LSI	1250A	1SDA062899R1	1SDA062907R1
	T7H1600 PR232/P-LSI	1600A	1SDA063027R1	1SDA063035R1
T7H P-LSIG	T7H800 PR331/P-LSIG	800A	1SDA062644R1	1SDA062652R1
	T7H1000 PR331/P-LSIG	1000A	1SDA062772R1	1SDA062780R1
	T7H1250 PR331/P-LSIG	1250A	1SDA062900R1	1SDA062908R1
	T7H1600 PR331/P-LSIG	1600A	1SDA063028R1	1SDA063036R1
T7H P-LSIG	T7H800 PR332/P-LSIG	800A	1SDA062647R1	1SDA062655R1
	T7H1000 PR332/P-LSIG	1000A	1SDA062775R1	1SDA062873R1
	T7H1250 PR332/P-LSIG	1250A	1SDA062903R1	1SDA062911R1
	T7H1600 PR332/P-LSIG	1600A	1SDA063031R1	1SDA063039R1

Pushbutton Operated

T7H P-LS/I	T7H800 PR231/P-LS/I	800A	1SDA062658R1	1SDA062666R1
	T7H1000 PR231/P-LS/I	1000A	1SDA062786R1	1SDA062794R1
	T7H1250 PR231/P-LS/I	1250A	1SDA062914R1	1SDA062922R1
	T7H1600 PR231/P-LS/I	1600A	1SDA063042R1	1SDA063050R1
T7H P-LSI	T7H800 PR232/P-LSI	800A	1SDA062659R1	1SDA062667R1
	T7H1000 PR232/P-LSI	1000A	1SDA062787R1	1SDA062795R1
	T7H1250 PR232/P-LSI	1250A	1SDA062915R1	1SDA062923R1
	T7H1600 PR232/P-LSI	1600A	1SDA063043R1	1SDA063051R1
T7H P-LSIG	T7H800 PR331/P-LSIG	800A	1SDA062660R1	1SDA062668R1
	T7H1000 PR331/P-LSIG	1000A	1SDA062788R1	1SDA062796R1
	T7H1250 PR331/P-LSIG	1250A	1SDA062916R1	1SDA062924R1
	T7H1600 PR331/P-LSIG	1600A	1SDA063044R1	1SDA063052R1
T7H P-LSIG	T7H800 PR332/P-LSIG	800A	1SDA062663R1	1SDA062671R1
	T7H1000 PR332/P-LSIG	1000A	1SDA062791R1	1SDA062799R1
	T7H1250 PR332/P-LSIG	1250A	1SDA062919R1	1SDA062927R1
	T7H1600 PR332/P-LSIG	1600A	1SDA063047R1	1SDA063055R1

Power distribution MCCBs

Type Tmax switch disconnectors



Fixed Pattern Circuit Breaker

Supplied as standard with front bar terminals for busbar - for other terminals see accessories section

Non Automatic

Model	I _{cn}	Current [A] I _u	Product Hierarchy 3000009 Order Code	
			3 Pole	4 Pole
XT1D 160 F F	2kA	160	1SDA068208R1	1SDA068209R1
XT3D 250 F F	3.6kA	250	1SDA068210R1	1SDA068211R1
XT4D 250 F F	3.6kA	250	1SDA068212R1	1SDA068213R1

Model	I _{cn}	Current [A] I _u	Product Hierarchy 3000006	
			3 Pole	4 Pole
T5D 400 F F	6kA	400	1SDA054599R1	1SDA054600R1
T5D 630 F F	6kA	630	1SDA054601R1	1SDA054602R1
T6D 630 F F	15kA	630	1SDA060343R1	1SDA060344R1
T6D 800 F F	15kA	1000	1SDA060345R1	1SDA060346R1
T6D 1000 F F	15kA	1250	1SDA060594R1	1SDA060595R1

Toggle Operated

Model	I _{cn}	Current [A] I _u	Product Hierarchy 3000006	
			3 Pole	4 Pole
T7D 1000 F F	25kA	1000	1SDA062032R1	1SDA062033R1
T7D 1250 F F	25kA	1250	1SDA062036R1	1SDA062037R1
T7D 1600 F F	25kA	1600	1SDA062040R1	1SDA062041R1

Pushbutton Operated

Model	I _{cn}	Current [A] I _u	Product Hierarchy 3000006	
			3 Pole	4 Pole
T7D 1000 M F F	25kA	1000	1SDA062034R1	1SDA062035R1
T7D 1250 M F F	25kA	1250	1SDA062038R1	1SDA062039R1
T7D 1600 M F F	25kA	1600	1SDA062042R1	1SDA062043R1

Power distribution MCCBs Type Tmax accessories





Starting from the fixed version circuit-breaker, all the other versions used for various requirements are obtained by means of mounting conversion kits.

The following are available:

- Kit for converting a fixed circuit-breaker into the moving part of a plug-in
- Circuit-breaker fixed parts for plug-in circuit-breakers
- Conversion kit for the connection terminals

Various accessories are also available:

- Shunt opening releases
- Undervoltage releases
- Auxiliary contacts
- Position contacts
- Advanced contacts on rotary handle
- Front and rear connection terminals
- Bracket for rear fixing on DIN EN 50022 rail
- Front interlocking plate
- Solenoid operating mechanism
- Rotary handle operating mechanism - direct on circuit-breaker and transmitted on compartment door
- Three-pole and four-pole residual current releases

Power distribution MCCBs

Type Tmax XT1 ... XT4 & T1 ... T7 accessories



Fixed part of plug-in

Plug-in (P) - Fixed Part

F = Front terminals	Product Hierarchy 3000009 Order Code	
	3 pole	4 pole
XT1 (max In=125A)	1SDA068183R1	1SDA068185R1
XT2	1SDA068187R1	1SDA051330R1
XT3	1SDA068192R1	1SDA051332R1
XT4	1SDA068196R1	1SDA054740R1

F = Front terminals	Product Hierarchy 3000006	
T5 400	1SDA054749R1	1SDA054752R1
T5 630 circuit breaker in plug-in version In max = 570A	1SDA054762R1	1SDA054765R1

HR = Rear flat horizontal terminals	Product Hierarchy 3000006	
T4	1SDA054739R1	1SDA054742R1
T5	1SDA054751R1	1SDA054754R1
T5 630 circuit breaker in plug-in version In max = 570A	1SDA054764R1	1SDA054767R1

VR = Rear flat vertical terminals	Product Hierarchy 3000006	
T4	1SDA054738R1	1SDA054741R1
T5	1SDA054750R1	1SDA054753R1
T5 630 circuit breaker in plug-in version In max = 570A	1SDA054763R1	1SDA054766R1

Withdrawable (W) - Fixed Part

F = Front terminals	Product Hierarchy 3000009 Order Code	
	3 pole	4 pole
XT2	1SDA068200R1	1SDA068202R1

F = Front terminals	Product Hierarchy 3000006	
T4	1SDA054743R1	1SDA054746R1
T5 400	1SDA054755R1	1SDA054758R1
T5 630 circuit breaker in plug-in version In max = 570A	1SDA054768R1	1SDA054771R1
T6	1SDA060384R1	1SDA060387R1
T7 - X1	1SDA062045R1	1SDA062049R1

HR = Rear flat horizontal terminals		
T4	1SDA054745R1	1SDA054748R1
T5 400	1SDA054757R1	1SDA054761R1
T5 630 circuit breaker in plug-in version In max = 570A	1SDA054770R1	1SDA054774R1
T6	1SDA060385R1	1SDA060388R1

VR = Rear flat horizontal terminals		
T4	1SDA054744R1	1SDA054747R1
T5 400	1SDA054756R1	1SDA054759R1
T5 630 circuit breaker in plug-in version In max = 570A	1SDA054769R1	1SDA054772R1
T6	1SDA060386R1	1SDA060389R1

HR/V = Rear flat terminals		
T7 - X1	1SDA062044R1	1SDA066276R1

Note: Fixed parts on T7 - T7M circuit breakers with **** terminals are supplied as standard with terminals mounted in horizontal. To order the terminals mounted vertically, use the extra code 1SDA063521R1

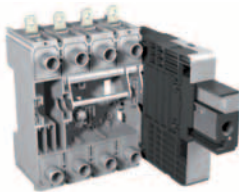

Fixed part of withdrawable

Power distribution MCCBs

Type Tmax XT1 ... XT4 & T1 ... T7 accessories



Conversion kit for turning a fixed circuit-breaker into the moving part of a plug-in circuit-breaker



Conversion kit for turning a fixed circuit-breaker into the moving part of a withdrawable circuit-breaker

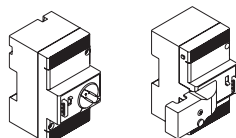
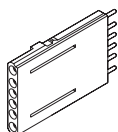
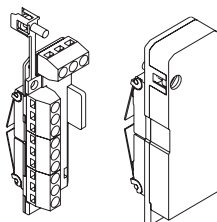

Conversion of Version

Conversion kit from fixed to moving part of plug-in part of plug-in	Product Hierarchy 3000009 Order Code	
	3 pole	4 pole
Kit P MP XT1 (max In=125A)	1SDA066276R1	1SDA066277R1
Kit P MP XT2	1SDA066278R1	1SDA066279R1
Kit P MP XT3	1SDA066280R1	1SDA066281R1
Kit P MP XT4	1SDA066282R1	1SDA066283R1

Conversion kit from fixed to moving part of plug-in part of plug-in	Product Hierarchy 3000006	
	Kit MP T5 400 P	1SDA054843R1
Kit MP T5 630 P (max In=570A)	1SDA054847R1	1SDA054848R1

Conversion kit from fixed to moving part of withdrawable	Product Hierarchy 3000009	
	Kit MP XT2 160 W	1SDA066284R1
Kit MP XT4 250 W	1SDA066286R1	1SDA066287R1

Conversion kit from fixed to moving part of withdrawable	Product Hierarchy 3000006	
	Kit MP T5 400 W	1SDA054845R1
Kit MP T5 630 W (max In=570A)	1SDA054849R1	1SDA054850R1
Kit MP T6 630/800 W	1SDA060390R1	1SDA060391R1
Kit MP T7-T7M-X1 W	1SDA062162R1	1SDA062163R1

Sliding Contacts T7-T7M

	Product Hierarchy 3000006
Left Sliding Contact MP	1SDA062164R1
Central Sliding Contact MP	1SDA062165R1
Right Sliding Contact MP	1SDA062166R1
Left Sliding Contact FP	1SDA062167R1
Central Sliding Contact FP	1SDA062168R1
Right Sliding Contact FP	1SDA062169R1

Note: Always to be ordered in pairs (block for MP & block for FP) if the circuit breaker is automatic or fitted with electrical accessories withdrawable version. For more information, please contact us.

The sliding contact blocks are needed for T7 in the withdrawable version fitted with electrical accessories or with an electronic release. Their function is to make the electrical connection of the secondary circuits between the moving and fixed part. These blocks operate in pairs: one block must be mounted on the moving part and the other on the fixed part. The following table shows the possible combinations between sliding contact blocks and electrical accessories.

Left hand lock	Central lock	Right hand lock
Spring charger motor	PR331	Auxiliary contacts
"Closed springs charged" contact	PR332	Shunt opening release
"Ready to close" contact		Shunt closing release
Release trip signalling		Under voltage release

Terminal Covers for Fixed Part

	Product Hierarchy 3000006
TC-FP T4 4p Terminal Covers Fixed/P	1SDA054858R1
TC-FP T5 400/630 4p Terminal Covers Fixed/P	1SDA054861R1

Power distribution MCCBs

Type Tmax XT1 ... XT4 & T1 ... T7 accessories

Services releases



SOR uncabled



SOR cabled



SOR for withdrawable

Shunt opening release - SOR	Product Hierarchy 3000009 Order Code
SOR-C XT1..XT4 F/P 12 Vdc	1SDA066321R1
SOR-C XT2-XT4 W 12 Vdc	1SDA066328R1
SOR-C XT1..XT4 F/P 24-30 Vac/dc	1SDA066322R1
SOR-C XT2-XT4 W 24-30 Vac/dc	1SDA066329R1
SOR-C XT1..XT4 F/P 48-60 Vac/dc	1SDA066323R1
SOR-C XT2-XT4 W 48-60 Vac/dc	1SDA066330R1
SOR-C XT1..XT4 F/P 110-127Vac-110-125Vdc	1SDA066324R1
SOR-C XT2-XT4 W 110-127Vac-110-125Vdc	1SDA066331R1
SOR-C XT1..XT4 F/P 220-240Vac-220-250Vdc	1SDA066325R1
SOR-C XT2-XT4 W 220-240Vac-220-250Vdc	1SDA066332R1
SOR-C XT1..XT4 F/P 380-440 Vac	1SDA066326R1
SOR-C XT2-XT4 W 380-440 Vac	1SDA066333R1
SOR-C XT1..XT4 F/P 480-525 Vac	1SDA066327R1
SOR-C XT2-XT4 W 480-525 Vac	1SDA066334R1

Shunt opening release - SOR	Product Hierarchy 3000006
SOR-C T4-T5-T6 12 Vdc	1SDA054869R1
SOR-C T4-T5-T6 48...60 Vac/dc	1SDA054871R1
SOR-C T4-T5-T6 110...127Vac - 110...1	1SDA054872R1
SOR-C T4-T5-T6 220...240Vac - 220...2	1SDA054873R1
SOR-C T4-T5-T6 380...440 Vac	1SDA054874R1
SOR-CT4-T5-T6 480...500Vac	1SDA054875R1

Shunt opening/closing release - SOR/SCR	Product Hierarchy 3000006
SOR/SCR T7-T7M-X1 24Va.c./d.c.	1SDA062065R1
SOR/SCR T7-T7M-X1 30Va.c./d.c.	1SDA062066R1
SOR/SCR T7-T7M-X1 48Va.c./d.c.	1SDA062067R1
SOR/SCR T7-T7M-X1 60Va.c./d.c.	1SDA062068R1
SOR/SCR T7-T7M-X1 110...120Va.c./d.c.	1SDA062069R1
SOR/SCR T7-T7M-X1 240...250Va.c./d.c.	1SDA062070R1
SOR/SCR T7-T7M-X1 380...400Va.c.	1SDA062071R1
SOR/SCR T7-T7M-X1 415...440Va.c.	1SDA062072R1

Under volage release - UVR	Product Hierarchy 3000009
UVR-C XT2-XT4 W 24-30 V ac/dc	1SDA066403R1
UVR-C XT1..XT4 F/P 48 V ac/dc	1SDA069065R1
UVR-C XT2-XT4 W 48 V ac/dc	1SDA069066R1
UVR-C XT1..XT4 F/P 60 V ac/dc	1SDA066397R1
UVR-C XT2-XT4 W 60 V ac/dc	1SDA066404R1
UVR-C XT1..XT4 F/P 110-127V ac-110-125Vdc	1SDA066398R1
UVR-C XT2-XT4 W 110-127V ac-110-125Vdc	1SDA066405R1
UVR-C XT1..XT4 F/P 220-240V ac-220-250Vdc	1SDA066399R1
UVR-C XT2-XT4 W 220-240V ac-220-250Vdc	1SDA066406R1
UVR-C XT1..XT4 F/P 380-440 V ac	1SDA066400R1
UVR-C XT2-XT4 W 380-440 V ac	1SDA066407R1
UVR-C XT1..XT4 F/P 480-525 V ac	1SDA066401R1
UVR-C XT2-XT4 W 480-525 V ac	1SDA066408R1



UVR uncabled



UVR cabled

Under volage release - UVR	Product Hierarchy 3000006
UVR-C T4-T5-T6 24-30 V ac/dc	1SDA054887R1
UVR-C T4-T5-T6 48 V ac/dc	1SDA054888R1
UVR-CT4-T5-T6 60V ac/dc	1SDA054889R1
UVR-C T4-T5-T6 110-127V ac-110-125Vdc	1SDA054890R1
UVR-C T4-T5-T6 220-250 V ac/dc	1SDA054891R1
UVR-C T4-T5-T6 380-440 V ac	1SDA054892R1
UVR-C T4-T5-T6 480-500V ac	1SDA054893R1

Power distribution MCCBs

Type Tmax XT1 ... XT4 & T1 ... T7 accessories

Services releases

Under volage release - UVR	Product Hierarchy 3000006 Order Code
UVR T7-T7M-X1 24Va.c./d.c.	1SDA062087R1
UVR T7-T7M-X130Va.c./d.c.	1SDA062088R1
UVR T7-T7M-X148Va.c./d.c.	1SDA062089R1
UVRT7-T7M-X160Va.c./d.c.	1SDA062090R1
UVR T7-T7M-X1 110...120Va.c./d.c.	1SDA062091R1
UVR T7-T7M-X1 240...250Va.c./d.c.	1SDA062092R1
UVR T7-T7M-X1 380...400Va.c.	1SDA062093R1
UVRT7-T7M-X1415...440Va.c.	1SDA062094R1



Time delay device for undervoltage release

Time delayed UVR	Product Hierarchy 3000006
UVD T1...T6 24...30Va.c./d.c.	1SDA051357R1
UVD T1...T6 48...60Va.c./d.c.	1SDA051358R1
UVD T1...T6 110...125Va.c./d.c.	1SDA051360R1
UVD T1...T6 220...250Va.c./d.c.	1SDA051361R1

Electronic Time Delay for UVR	Product Hierarchy 3000006
24/30V E1/6-T7-X1-T8	1SDA038316R1
48V E1/6-T7-X1-T8	1SDA038317R1
60V E1/6-T7-X1-T8	1SDA038318R1
110-127V E1/6-T7-X1-T8	1SDA038319R1
220-250V E1/6-T7-X1-T8	1SDA038320R1

Electrical Signals

Auxiliary contact - AUX	Product Hierarchy 3000009 Order Code
AUX-C 1Q+1SY 250 V XT1..XT4 F/P	1SDA066431R1
AUX-C 3Q+1SY 250 V XT2..XT4 F/P	1SDA066434R1
AUX-C 3Q+1SY 24 Vdc XT2..XT4 F/P	1SDA066448R1

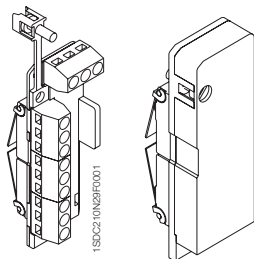

Auxiliary contact - AUX	Product Hierarchy 3000006
AUX-C T4-T5-T6 1Q 1SY 250 Vac/dc	1SDA054910R1
AUX-C T4-T5-T6 3Q 1SY 250 Vac/dc	1SDA054911R1
AUX-C T4-T5-T6 1Q 1SY 400 Vac	1SDA054912R1
AUX-C T4-T5-T6 2Q 400 Vac	1SDA054913R1
AUX-C T4-T5-T6 3Q 1SY 24 Vdc	1SDA054915R1

Cabled contact for signalling trip coil release	Product Hierarchy 3000006
AUX-SA T4-T5 1S51 not for PR221-222-223	1SDA055050R1
AUX-SA T6 1S51 for PR221-222-223	1SDA060393R1

Cabled contact for signalling motor operation T4-T5-T6	Product Hierarchy 3000006
AUX-MOE-C T4-T5-T6 1Q x signal manual/automatic	1SDA054917R1

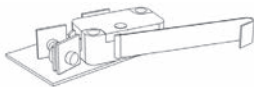

Auxiliary contact - AUX	Product Hierarchy 3000006
AUX T7 1Q + 1SY 400Va.c.	1SDA062104R1
AUX T7 1Q + 1SY 24Vd.c.	1SDA062103R1
AUX T7-T7M-X1 2Q 400Va.c.	1SDA062102R1
AUX T7-T7M-X1 2Q 24Vd.c.	1SDA062101R1
AUX-SA T7 1 S51 250Va.c.	1SDA062105R1
AUX-SA T7M-X1 1 S51 250Va.c.	1SDA063553R1

Aux contact for ready for ready to close T7M	Product Hierarchy 3000006
AUX-RTC T7M - X1 24Vd.c. ready to close	1SDA062108R1
AUX-RTC T7M - X1 250Va.c./d.c. ready to close	1SDA062109R1

Aux contact for springs charged	Product Hierarchy 3000006
AUX-SC T7M - X1 24Vd.c. spring charged	1SDA062106R1
AUX-SC T7M - X1 250Vac/dc spring charged	1SDA062107R1

Power distribution MCCBs

Type Tmax XT1 ... XT4 & T1 ... T7 accessories

Electrical Signals

	Product Hierarchy 3000006 Order Code
Early auxiliary contact	
AUE T1-T2-T3 2 early contacts	1SDA051374R1
AUE T4-T5 250Vac/dc 2 early contacts	1SDA054925R1
AUE T6 250Vac/dc 2 early contacts	1SDA060394R1
AUE T7 400Va.c. 3 early contacts	1SDA062112R1
Aux position contact	
AUP T2-T3 con inserted signalling	1SDA051372R1
AUP-I T4-T5-T6 con inserted signalling	1SDA054918R1
AUP-I T4-T5-T6 24 Vdc con inserted signalling	1SDA054920R1
AUP-R T4-T5-T6 24 Vdc con withdraw signalling	1SDA054921R1
AUP-R T4-T5-T6 con withdraw signalling	1SDA054919R1
AUP T7-T7M-X1 24Vd.c. (2INS+2TEST+2EXT)	1SDA062110R1
AUP T7-T7M-X1 250Va.c. (2INS+2TEST+2EXT)	1SDA062111R1
Adapters	
ADP 5pin SOR/UVR RC T4-T5-T6 P/W	1SDA055173R1
ADP 6pin AUX T4-T5-T6 P/W	1SDA054922R1
ADP 12pin AUX T4-T5-T6 P/W	1SDA054923R1
ADP 10pin MOE AUE T4-T5-T6 P/W	1SDA054924R1

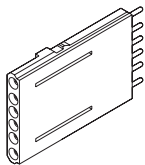
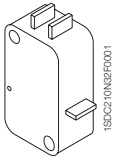

Mechanical Signals

	Product Hierarchy 3000006 Order Code
Test Extension	
Trip Reset 110..130Vac/dc T7 pushbutton operated	1SDA062118R1
Trip Reset 200..240Vac/dc T7 pushbutton operated	1SDA062119R1
Trip Reset	
Operation Counter T7 pushbutton operated	1SDA062160R1

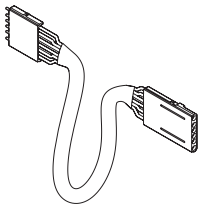

Motor Operators

	Product Hierarchy 3000009 Order Code
Stored energy motor operator MOE	
MOE XT2-XT4 24 Vdc	1SDA066463R1
MOE XT2-XT4 48...60 Vdc	1SDA066464R1
MOE XT2-XT4 110...125 Vac/dc	1SDA066465R1
MOE XT2-XT4 220...250 Vac/dc	1SDA066466R1
MOE XT2-XT4 380 Vac	1SDA066467R1
MOE XT2-XT4 480...525 Vac	1SDA066468R1
Stored energy motor operator MOE	Product Hierarchy 3000006
MOE T4-T5 24 Vdc	1SDA054894R1
MOE T4-T5 48...60 Vdc	1SDA054895R1
MOE T4-T5 110...125 Vac/dc	1SDA054896R1
MOE T4-T5 220...250 Vac/dc	1SDA054897R1
MOE T4-T5 380 Vac	1SDA054898R1
MOE T6 24 Vdc	1SDA060395R1
MOE T6 48...60Vdc	1SDA060396R1
MOE T6 110...125 Vac/dc	1SDA060397R1
MOE T6 220...250 Vac/dc	1SDA060398R1
MOE T6 380Vac	1SDA060399R1



MOE - Motor operator

Power distribution MCCBs

Type Tmax XT1 ... XT4 & T1 ... T7 accessories

Motor Operators

Motor operator with direct action MOD	Product Hierarchy 3000009 Order Code
MOD XT1-XT3 24 Vdc	1SDA066457R1
MOD XT1-XT3 48...60 Vdc	1SDA066458R1
MOD XT1-XT3 110...125 Vac/dc	1SDA066459R1
MOD XT1-XT3 220...250 Vac/dc	1SDA066460R1
MOD XT1-XT3 380 Vac	1SDA066461R1
MOD XT1-XT3 480...525 Vac	1SDA066462R1

Spring charging motor	Product Hierarchy 3000006
Spring charging motor T7M-X1 24...30Vac/dc	1SDA062113R1
Spring charging motor T7M-X148...60Vac/dc	1SDA062114R1
Spring charging motor T7M-X1 100...130Vac/	1SDA062115R1
Spring charging motor T7M-X1 220...250 Vac	1SDA062116R1
Spring charging motor T7M-X1 380...415Vac	1SDA062117R1

Rotary Handle Operating Mechanism



Direct handle

Breaker	Direct - RHD	Product Hierarchy 3000009 Order Code
XT1-XT2-XT3	RHD Standard for fixed and plug-in	1SDA066475R1
	RHD Emergency for fixed and plug-in	1SDA066477R1
XT2-XT4	RHD Standard with-drawable	1SDA066476R1
	RHD Emergency with-drawable	1SDA066478R1

Product Hierarchy 3000006		
T4-T5	RHD Standard for fixed and plug-in	1SDA054926R1
	RHD Emergency for fixed and plug-in	1SDA054927R1
	RHD Standard with-drawable	1SDA054928R1
	RHD Emergency with-drawable	1SDA055234R1
T6	RHD Standard for fixed and plug-in	1SDA060405R1
	RHD Emergency for fixed and plug-in	1SDA060406R1
	RHD Standard with-drawable	1SDA060407R1
T7 Toggle operated	RHD Emergency with-drawable	1SDA060408R1
	RHD Standard for fixed and plug-in	1SDA062120R1
	RHD Emergency for fixed and plug-in	1SDA062121R1
T7 Toggle operated	RHD Standard with-drawable	1SDA062120R1
	RHD Emergency with-drawable	1SDA062121R1



Transmitted handle

Breaker	Door Mounted Extended - RHE	Product Hierarchy 3000009
XT1-XT2-XT3	RHE Standard for fixed and plug-in	1SDA066479R1
	RHE Emergency for fixed and plug-in	1SDA066481R1
XT2-XT4	RHE Standard with-drawable	1SDA066480R1
	RHE Emergency with-drawable	1SDA066482R1

Product Hierarchy 3000006		
T4-T5	RHE Standard for fixed and plug-in	1SDA054929R1
	RHE Emergency for fixed and plug-in	1SDA054930R1
	RHE Standard with-drawable	1SDA054933R1
	RHE Emergency with-drawable	1SDA054934R1
T6	RHE Standard for fixed and plug-in	1SDA060409R1
	RHE Emergency for fixed and plug-in	1SDA060410R1
	RHE Standard with-drawable	1SDA060411R1
T7 Toggle operated	RHE Emergency with-drawable	1SDA060412R1
	RHE Standard for fixed and plug-in	1SDA062122R1
	RHE Emergency for fixed and plug-in	1SDA062123R1
T7 Toggle operated	RHE Standard with-drawable	1SDA062122R1
	RHE Emergency with-drawable	1SDA062123R1

Power distribution MCCBs

Type Tmax XT1 ... XT4 & T1 ... T7 accessories

Operating mechanism and locks



Fixed padlock



Key lock on the circuit-breaker



Key lock on the handle



Key lock on the motor

Padlock lever lock PPL	Breaker	Product Hierarchy 3000009 Order Code
PLL - removable lock with padlocks in open position	XT1-XT3	1SDA066588R1
PLL - fixed lock with padlocks in open position		1SDA066589R1
PLL - fixed lock with padlocks in open/close position		1SDA066591R1
PLL - fixed lock with padlocks in open position	XT2-XT4	1SDA066590R1
PLL - fixed lock with padlocks in open/close position		1SDA066592R1
Padlock lever lock PPL		Product Hierarchy 3000006
PLL - padlock pushbutton in open position	T7 pushbutton opp.	1SDA062151R1
PLL - padlock lever in open position	T7 toggle	1SDA062150R1
Key locks KLC		Product Hierarchy 3000009
KLC BL.Ronis locked in open position	XT1	1SDA066593R1
KLC BL.Ronis locked in open position	XT2-XT4	1SDA066599R1
KLC BL.Ronis locked in open position	XT3	1SDA066605R1
Key locks KLC		Product Hierarchy 3000006
KLC-D key lock service operation	T7	1SDA062134R1
KLC key lock Ronis operator adapter		1SDA062139R1
KLC key lock Profalux operator adapter		1SDA062140R1
Key locks front/rotary handle KLF		Product Hierarchy 3000006
KLF-D different keys	T4-T5	1SDA054939R1
KLF-S same keys		1SDA054940R1
KLF-D different keys	T6	1SDA060658R1
KLF-S key lock EQ.20005		1SDA060659R1
Key locks extended rotary handle shaft		Product Hierarchy 3000009
Castell lock adapter	XT1-XT2-XT3	OETLZW16
	XT4-T7	OETLZW5
Key locks motor operator MOL		Product Hierarchy 3000006
MOL-D different keys	T4-T5	1SDA054904R1
	T6	1SDA060611R1
MOL-S same key for different groups (N.20005)	T4-T5	1SDA054905R1
	T6	1SDA060612R1
MOL-M manual operation same key	T4-T5	1SDA054909R1
	T6	1SDA060616R1
Key lock in open position on the circuit breaker pushbutton operated		Product Hierarchy 3000006
KLC-D key lock service operation	T7 Pushbutton opp.	1SDA062141R1
KLC Ronis-Profalux		1SDA062146R1
Key lock on handle		Product Hierarchy 3000009
RHL Ronis different keys	XT1-XT4	1SDA066617R1
RHL Ronis Type A		1SDA066618R1
Key lock in racked-in/test isolated/rack-out position		Product Hierarchy 3000006
Arrangement for Ronis key lock - can be equipped with two different keys T7		1SDA063567R1
Arrangement for Profalux key lock T7		1SDA063570R1
Arrangement for Castell key lock T7		1SDA063568R1
Arrangement for Kirk key lock T7		1SDA063569R1
Front lock device		Product Hierarchy 3000009
FLD XT2-XT4 F/P		1SDA066635R1
FLD XT2-XT4 W		1SDA066636R1
FLD T4-T5 F/P		1SDA054944R1
Front lock device		Product Hierarchy 3000006
FLD T4-T5 W		1SDA054945R1
FLD T6 F/P		1SDA060417R1
FLD T6 W		1SDA060418R1

Power distribution MCCBs

Type XT1 ... XT4 & T1 ... T7 accessories

Operating mechanism and locks



Interlock

	Product Hierarchy 3000006 Order Code
Transparent Protection for Pushbutton	
Pushbuttons trans protection T7 pushbutton operated	1SDA062132R1
Pushbuttons trans protection independant	1SDA062133R1
IP54 protection T7 pushbutton operated	1SDA062161R1
Mechanical Interlock MIR	
Product Hierarchy 3000006	
T4-T5 Horizontal Interlock Frame	1SDA054946R1
T4-T5 Vertical Interlock Frame	1SDA054947R1
T4-T5 Type A Interlock Plate T4 (F-P-W) + T4 (F-P-W)	1SDA054948R1
T4-T5 Type B Interlock Plate T4 (F-P-W) + T5 400 (F-P-W)	1SDA054949R1
T4-T5 Type C Interlock Plate T6 (F-P-W) + T5 630 (P-W)	1SDA054950R1
T4-T5 Type D Interlock Plate T5 400 (F-P-W) or T5 630 (F) + T5 400 (F-P-W) or T5 630 (F)	1SDA054951R1
T4-T5 Type E Interlock Plate T5 400 (F-P-W) or T5 630 (F) + T5 630 (F-W)	1SDA054952R1
T4-T5 Type F Interlock Plate T5 630 (P-W) + T5 630 (P-W)	1SDA054953R1
T6 Mechanical Interlock - Horizontal	1SDA060685R1
T6 Mechanical Interlock - Vertical	1SDA060686R1

Note: To interlock two T4-T5 circuit breakers you have to order a frame unit interlock and plate (for type A or B or C or D or E or F) interlock

	Product Hierarchy 3000006
Mechanical Interlock with cables	
Kit cable mechanical Interlock HR/VR T7-T7M	1SDA062127R1
Plate mechanical Interlock T7-T7M back plate fixed	1SDA062129R1
Plate mechanical Interlock T7M F floor fixed	1SDA062130R1
Plate mechanical Interlock T7-T7M W	1SDA062131R1



RC Sel

	Product Hierarchy 3000009
Residual Current Devices	
RC Sel x XT1 3p F	1SDA067123R1
RC Sel x XT1 4p F	1SDA067125R1
RC Sel x XT2 4p F	1SDA067126R1
RC Sel x XT3 3p F	1SDA067128R1
RC Sel x XT3 4p F	1SDA067130R1
RC Sel x XT4 4p F	1SDA067131R1
Product Hierarchy 3000006	
RC 222/5 for T5 4p F	1SDA054955R1

Power distribution MCCBs

Type XT1 ... XT4 & T1 ... T7 accessories



Shrouds and terminals

	Product Hierarchy 3000009 Order Code
High shields	
XT1 3P High Terminal shields (Pair) - HTC	1SDA066664R1
XT1 4P High Terminal shields (Pair) - HTC	1SDA066665R1
XT2 3P High Terminal shields (Pair) - HTC	1SDA066666R1
XT2 4P High Terminal shields (Pair) - HTC	1SDA066667R1
XT3 3P High Terminal shields (Pair) - HTC	1SDA066668R1
XT3 4P High Terminal shields (Pair) - HTC	1SDA066669R1
XT4 3P High Terminal shields (Pair) - HTC	1SDA066670R1
XT4 4P High Terminal shields (Pair) - HTC	1SDA066671R1
High shields	
Product Hierarchy 3000006	
T5 3P High Terminal Shields (Pair)	1SDA054960R1
T5 4P High Terminal Shields (Pair)	1SDA054961R1
T6 3P High Terminal Shields (Pair)	1SDA014040R1
T6 4P High Terminal Shields (Pair)	1SDA014041R1
T7/T7M 3P High Terminal Shields (Pair)	1SDA063091R1
T7/T7M 4P High Terminal Shields (Pair)	1SDA063092R1
Low shields	
Product Hierarchy 3000009	
XT1 3P Low Terminal shields (Pair) - HTC	1SDA066655R1
XT1 4P Low Terminal shields (Pair) - HTC	1SDA066656R1
XT2 3P Low Terminal shields (Pair) - HTC	1SDA066657R1
XT2 4P Low Terminal shields (Pair) - HTC	1SDA066659R1
XT3 3P Low Terminal shields (Pair) - HTC	1SDA066660R1
XT3 4P Low Terminal shields (Pair) - HTC	1SDA066661R1
XT4 3P Low Terminal shields (Pair) - HTC	1SDA066662R1
XT4 4P Low Terminal shields (Pair) - HTC	1SDA066663R1
Low shields	
Product Hierarchy 3000006	
T5 3P Low Terminal Shields (Pair)	1SDA054968R1
T5 4P Low Terminal Shields (Pair)	1SDA054969R1
T6 3P Low Terminal Shields (Pair)	1SDA014038R1
T6 4P Low Terminal Shields (Pair)	1SDA014039R1
T7/T7M 3P Low Terminal Shields (Pair)	1SDA063093R1
T7/T7M 4P Low Terminal Shields (Pair)	1SDA063094R1
Phase barriers	
Product Hierarchy 3000006	
PB100 T4-5-T7-X1 3p PART.DIV.PHA.LOW	1SDA054970R1
PB100 T4-5-T7-X1 4p PART.DIV.PHA.LOW	1SDA054971R1
PB200 T4-5-7-T7M-X1 3p PART.DIV.PHA.HIGH	1SDA054972R1
PB200 T4-5-7-T7M-X1 4p PART.DIV.PHA.HIGH	1SDA054973R1
Extended front terminals	
Product Hierarchy 3000009	
KIT EF XT1 3 poles	1SDA066865R1
KIT EF XT2 3 poles	1SDA066869R1
KIT EF XT3 3 poles	1SDA066873R1
KIT EF XT4 3 poles	1SDA066877R1
KIT EF XT1 4 poles	1SDA066866R1
KIT EF XT2 4 poles	1SDA066870R1
KIT EF XT3 4 poles	1SDA066874R1
KIT EF XT4 4 poles	1SDA066878R1
Extended front terminals	
Product Hierarchy 3000006	
KIT EF T5 3 poles	1SDA055036R1
KIT EF T6 630 3 poles	1SDA023379R1
KIT EF T6 800 3 poles	1SDA023383R1
KIT EF T7-T7M-X1 3 poles	1SDA063103R1
KIT EF T5 4 poles	1SDA055037R1
KIT EF T6 630 4 poles	1SDA023389R1
KIT EF T6 800 4 poles	1SDA023393R1
KIT EF T7-T7M-X1 4 poles	1SDA063104R1

Power distribution MCCBs

Type XT1 ... XT4 & T1 ... T7 accessories

Shrouds and terminals



FCCuAl Terminal

Terminals for CuAl cables	Product Hierarchy 3000009 Order Code
FC CuAl 1x35...95mm ² XT1 3 poles	1SDA067155R1
FC CuAl 1x2.5...95mm ² XT2 3 poles	1SDA067163R1
FC CuAl 2x35...95mm ² XT2 3 poles	1SDA067175R1
FC CuAl 1x70...185mm ² XT2 3 poles	1SDA067167R1
FC CuAl 2x35...150mm ² XT3 3 poles	1SDA067187R1
FC CuAl 1x90...185mm ² XT3 3 poles	1SDA067179R1
FC CuAl 1x150...240mm ² XT3 3 poles+ADP	1SDA067183R1
FC CuAl 1x2.5...185mm ² XT4 3 poles	1SDA067191R1
FC CuAl 2x35...150mm ² XT4 3 poles	1SDA067199R1
FC CuAl 1x2.5...185mm ² XT4 3 poles	1SDA067191R1
FC CuAl 1x35...95mm ² XT1 4 poles	1SDA067156R1
FC CuAl 1x2.5...95mm ² XT2 4 poles	1SDA067164R1
FC CuAl 2x35...95mm ² XT2 4 poles	1SDA067176R1
FC CuAl 1x70...185mm ² XT2 4 poles	1SDA067168R1
FC CuAl 2x35...150mm ² XT3 4 poles	1SDA067188R1
FC CuAl 1x90...185mm ² XT3 4 poles	1SDA067180R1
FC CuAl 1x150...240mm ² XT3 4 poles+ADP	1SDA067184R1
Terminals for CuAl cables	Product Hierarchy 3000006
FC CuAl 2x120mm ² T5 400 3 poles	1SDA055028R1
FC CuAl 1x240mm ² T5 400 3 poles	1SDA055020R1
FC CuAl 1x300mm ² T5 400 3 poles	1SDA055024R1
FC CuAl 2x240mm ² T5 630 3 poles	1SDA055032R1
FC CuAl 2x240mm ² T6 630-S6 630 3 poles	1SDA023380R1
FC CuAl 3x185mm ² T6 800-S6 800 3 poles	1SDA023384R1
FC CuAl 4x150mm ² T6 1000 3 poles	1SDA060687R1
FC CuAl 4x240mm ² T7-T7M 1250 3 poles	1SDA063112R1
FC CuAl 2x120mm ² T5 400 4 poles	1SDA055029R1
FC CuAl 1x240mm ² T5 400 4 poles	1SDA055021R1
FC CuAl 1x300mm ² T5 400 4 poles	1SDA055025R1
FC CuAl 2x240mm ² T5 630 4 poles	1SDA055033R1
FC CuAl 2x240mm ² T6 630-S6 630 4 poles	1SDA023390R1
FC CuAl 3x185mm ² T6 800-S6 800 4 poles	1SDA023394R1
FC CuAl 4x150mm ² T6 1000 4 poles	1SDA060688R1
FC CuAl 4x240mm ² T7-T7M 1250 4 poles	1SDA063113R1
Front terminals	Product Hierarchy 3000009
KIT F XT1 3 poles	1SDA066849R1
KIT F XT2 3 poles	1SDA066853R1
KIT F XT3 3 poles	1SDA066857R1
KIT F XT4 3 poles	1SDA066861R1
KIT F XT1 4 poles	1SDA066850R1
KIT F XT2 4 poles	1SDA066854R1
KIT F XT3 4 poles	1SDA066858R1
KIT F XT4 4 poles	1SDA066862R1
Front terminals	Product Hierarchy 3000006
KIT F T5 3 poles	1SDA055012R1
KIT F T6 630/800 - S6 630/800 3 poles	1SDA060421R1
KIT F T7-T7M 3 poles	1SDA063099R1
KIT F T5 4 poles	1SDA055013R1
KIT F T6 630/800 - S6 630/800 4 poles	1SDA060422R1
KIT F T7-T7M 4 poles	1SDA063100R1

Power distribution MCCBs

Type XT1 ... XT4 & T1 ... T7 accessories

Shrouds and terminals	Product Hierarchy 3000009
Extended spread front terminals	Order Code
KIT ES XT2 3 poles	1SDA066893R1
KIT ES XT3 3 poles	1SDA066897R1
KIT ES XT4 3 poles	1SDA066901R1
KIT ES XT2 4 poles	1SDA066894R1
KIT ES XT3 4 poles	1SDA066898R1
KIT ES XT4 4 poles	1SDA066902R1
Extended spread front terminals	Product Hierarchy 3000006
KIT ES T5 3 poles	1SDA055040R1
KIT ES UP T6 - S6 3 poles	1SDA050692R1
KIT ES LO T6 - S6 3 poles	1SDA050704R1
KIT ES T7-T7M 3 poles UPP	1SDA063107R1
KIT ES T7-T7M 3 poles LOW	1SDA063108R1
KIT ES T5 4 poles	1SDA055041R1
KIT ES T6 - S6 4 poles	1SDA050693R1
KIT ES T7-T7M 4 poles	1SDA063109R1
Terminals for Cu cables	Product Hierarchy 3000009
KIT FC Cu XT2 3 poles	1SDA066909R1
KIT FC Cu XT3 3 poles	1SDA066913R1
KIT FC Cu XT4 3 poles	1SDA066917R1
KIT FC Cu XT2 4 poles	1SDA066910R1
KIT FC Cu XT3 4 poles	1SDA066914R1
KIT FC Cu XT4 4 poles	1SDA066918R1
Terminals for Cu cables	Product Hierarchy 3000006
KIT FC Cu 1x240mm ² T5 400 3 poles	1SDA055016R1
KIT FC Cu 2x240mm ² T5 630 3 poles	1SDA055364R1
KIT RC 2x150mm ² T6 630 3 poles	1SDA023381R1
KIT 1/2 3p F F>F RC T6 800	1SDA023385R1
KIT FC Cu 1x240mm ² T5 400 4 poles	1SDA055017R1
KIT FC Cu 2x240mm ² T5 630 4 poles	1SDA055365R1
KIT RC 2x150mm ² T6 630 4 poles	1SDA023391R1
KIT RC 3x240mm ² T6 800 4 poles	1SDA023395R1
Rear adjustable terminals	Product Hierarchy 3000009
KIT R XT2 3 poles	1SDA066941R1
KIT R XT3 3 poles	1SDA066945R1
KIT R XT4 3 poles	1SDA066949R1
KIT R XT2 4 poles	1SDA066942R1
KIT R XT3 4 poles	1SDA066946R1
KIT R XT4 4 poles	1SDA066950R1
Rear adjustable terminals	Product Hierarchy 3000006
KIT R T5 3 poles	1SDA055044R1
KIT R T6 3 poles	1SDA060425R1
KIT R T7-T7M 3 poles	1SDA063116R1
KIT R T5 4 poles	1SDA055045R1
KIT R T6 4 poles	1SDA060426R1
Rear horizontal connectors	Product Hierarchy 3000006
KIT HR T7-T7M 3 poles	1SDA063120R1
KIT HR T7-T7M 4 poles	1SDA063121R1
Rear vertical connectors	Product Hierarchy 3000006
KIT VR T7-T7M 3 poles	1SDA063124R1
KIT VR T7-T7M 4 poles	1SDA063125R1

Power distribution MCCBs

Type XT1 ... XT4 & T1 ... T7 accessories

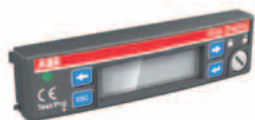

Ekip Display



Ekip LED Meter

Front display unit

FDU T4-T5 front display unit x PR222-223
 FDU T6 front display unit x PR222-PR223

Product Hierarchy 3000006
 Order Code

1SDA055051R1
 1SDA060429R1



ATS021

Automatic transfer switches

ATS021 DISP.COMMUT.AUT.S/D MULTI TENS
 ATS022 DISP.COMMUT.AUT.C/D CONT.AV.M/TEN

Product Hierarchy 3000006

1SDA065523R1
 1SDA065524R1

Accessories for electronic trip units

HMI030 switch display unit T4..T7
 PR330/V measuring module PR332 T7
 PR330/D-M communication module PR332-3 T7-T7M
 PR330/R driving unit PR332-3 T7-T7M
 PR030/B battery unit E1/6-T7-T7M-X1

Product Hierarchy 3000006

1SDA063143R1
 1SDA063144R1
 1SDA063145R1
 1SDA063146R1
 1SDA058258R1



Ekip T&P unit

Test and Configurator Unit

Ekip TT XT2-XT4
 Ekip T&P

Product Hierarchy 3000009

1SDA066988R1
 1SDA066989R1

Contact us

ABB Ltd

Tower Court
Foleshill Enterprise Park
Courtaulds Way
Coventry CV6 5NX

Tel: 0333 999 9900

Fax: 0333 999 9901

Email: LV.Enquiries@gb.abb.com

Twitter: @ABBUKLVP

www.abb.co.uk/lowvoltage

Note: We reserve the right to make technical changes or modify the contents of this document without prior notice. With regard to purchase orders, the agreed particulars shall prevail. ABB Ltd does not accept any responsibility whatsoever for potential errors or possible lack of information in this document.

We reserve all rights in this document and in the subject matter and illustrations contained therein. Any reproduction, disclosure to third parties or utilization of its contents – in whole or in parts – is forbidden without prior written consent of ABB Ltd.

Copyright © 2015 ABB Ltd

All rights reserved