

LB PLUS busbar trunking systems

technical information

Trunking components

Feed unit 254

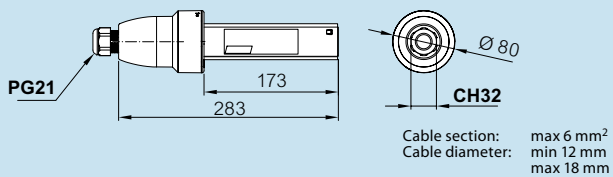

Feed unit (reduced dimensions) 40 / 63 A

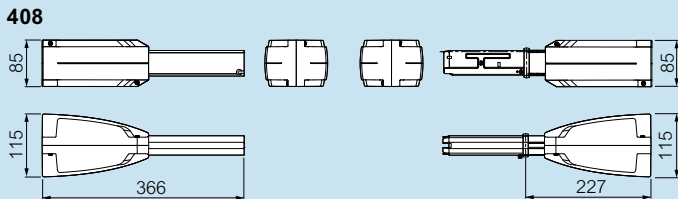

404 / 634

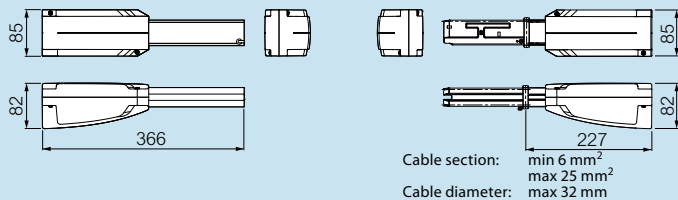

End cover

Right

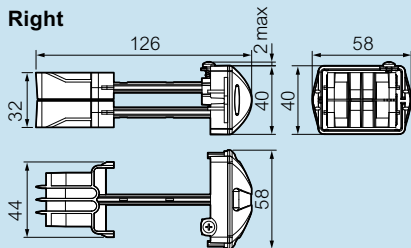

Left

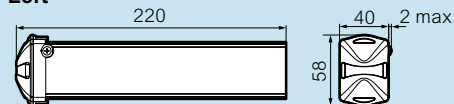

Flexible joint (reduced dimensions) 404 / 408 / 634

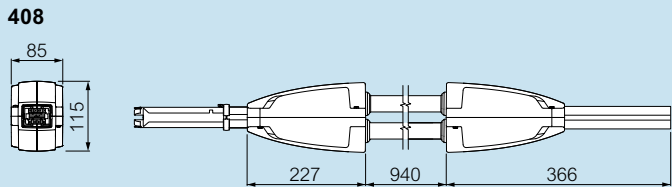

404 / 603

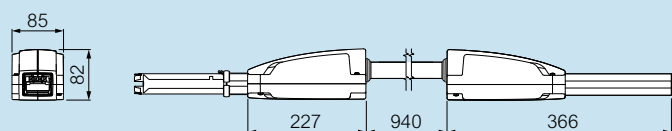

Tap-offs

PLUG 10 A

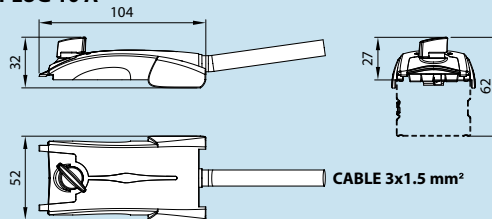

PLUG 10A
L1-N GREY
L2-N ORANGE
L3-N BLUE
L-N2 MAGENTA

Plug 16 A

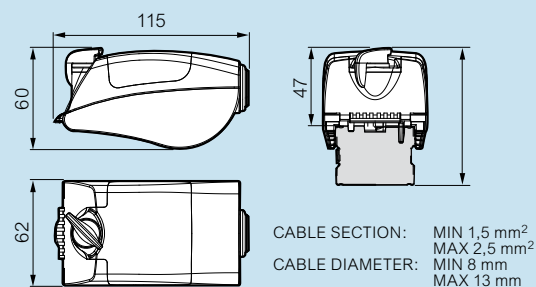

Plug 25 A

Cat. Nos. 75007005 / 75007205

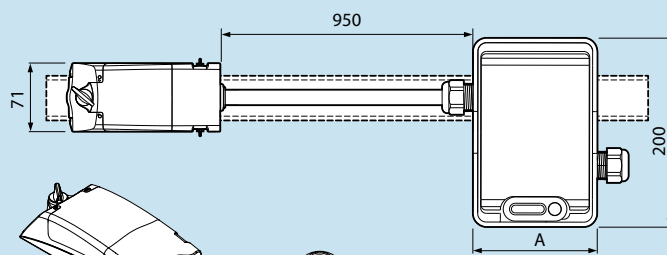
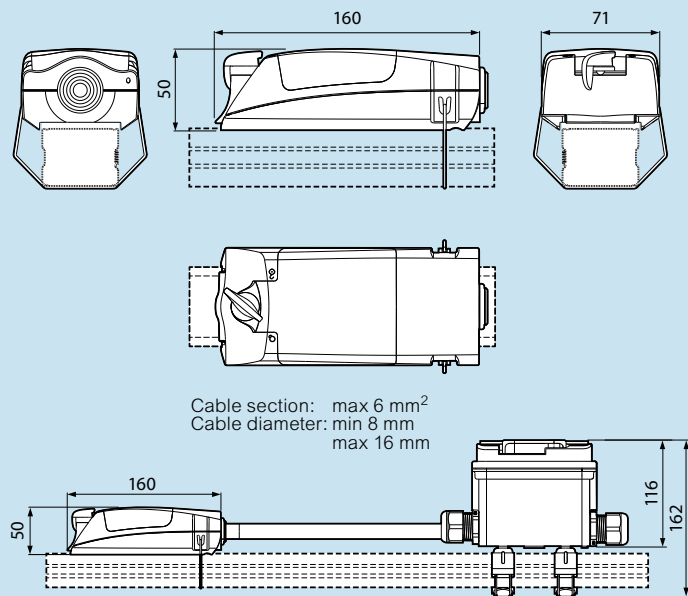

A = 128 mm (4 DIN)
200 mm (8 DIN)

