

A FUSION OF **ENGINEERING** AND DESIGN

High specification solutions recognized globally for fully accountable performance, functionality and flexibility.

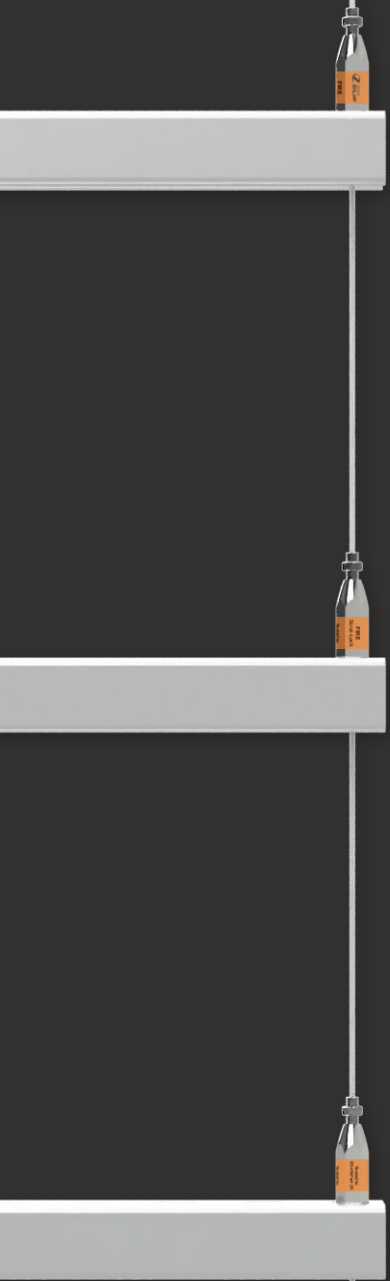

WIRE ROPE SYSTEMS **SOLUTION OVERVIEW**

SUSPENSION



**HVAC and
Mechanical**



**Electrical and
Lighting**



**Signage and
Panels**



THE QUEEN'S AWARDS
FOR ENTERPRISE:
INTERNATIONAL TRADE
2019



SAFETY | SUSPENSION | SPEED



WHO ARE ZIP-CLIP?

Zip-Clip are leading designers and manufacturers of high specification wire suspension and bracing solutions developed by experienced in-house R&D teams in close consultation with specifiers, engineers, and contractors. The systems are recognized globally for their fully accountable performance, functionality and flexibility.

WHY USE ZIP-CLIP WIRE SOLUTIONS?

The wire used in Zip-Clip systems is a premium grade product and is available in load ranges from 15 kg to 500 kg with all systems designed to include a safety factor of up to 5:1.

This proven level of performance and accountability allows specifiers and installers to confidently use wire in place of traditional threaded rod supported suspension for countless end-use applications.

The benefits of wire rope are many – Reduction in materials and number of components, with significant associated time, cost and environmental advantages, ease of availability, ease of transportation, ease of storage, ease of install, and the applied system safety factor, to name but a few.

2 mm wire performs at the same level as 10 mm rod and you can easily carry 200 x 1 metre drops of wire rope and clips to site in a rucksack!

WHERE CAN I USE WIRE?

Zip-Clip wire rope systems are typically used within the construction industry for the suspension and/or bracing of:

- Electrical containment trays, baskets or ladders,
- Lighting,
- HVAC and mechanical services,
- Acoustic or radiant heating panels,
- Signage, screens and partitions.

If you automatically think of using rigid threaded bars to solve your suspension and bracing needs, you may want to think again and look at all the advantages offered by wire, the truly flexible alternative.

FIXING SOLUTIONS

The Zip-Clip range offers a variety of suspension options to suit light, medium and heavy duty applications. Anchoring solutions are available for concrete, steel frame, metal-deck and wooden structures.

Concrete anchors compliant to BS 8539:2012 (The selection and installation of post installed anchors in concrete and masonry) can be tested on site by CFA (Construction Fixings Association) certified technical managers. This service is available on request.

INDEPENDENTLY TESTED

All Zip-Clip suspension and bracing solutions offer fully assured performance and accountability and are independently tested to exacting standards.



For details of test undertaken and copies of test certificates please contact our offices.

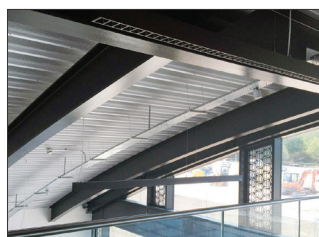
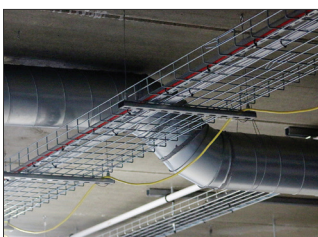
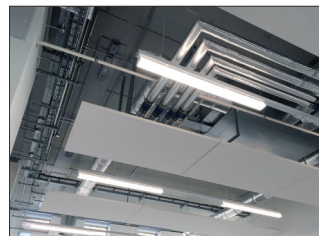

INTRODUCTION TO ZIP-CLIP WIRE ROPE

Zip-Clip suspension and bracing systems utilise premium grade high strength wire rope made from Extra Improved Plow Steel (EIPS) which exhibits minimal permanent elongation under design load. The wire is manufactured in accordance with **BS EN 12385, ASTM A1023/A1023M**. For seismic bracing applications, the effective modulus of elasticity of each wire rope size has been independently verified and break strength has been tested to **ASTM A931**.

AVAILABLE SYSTEMS (All with a 5:1 Safety Factor)

Galvanised mild steel electroplated wire rope:

Wire Code	SWL of Wire	Construction	Tensile Strength
G	15 kg	7×7 (6/1) RHRL	1960 N/mm ²
S	50 kg	7×7 (6/1) RHRL	1960 N/mm ²
Y	120 kg	7×7 (6/1) RHRL	1960 N/mm ²
P	300 kg	7×19 (6/1) RHRL	1960 N/mm ²
N	500 kg	7×19 (6/1) RHRL	1960 N/mm ²

Stainless steel wire rope:

Wire Code	SWL of Wire	Construction	Grade
G	8 kg	7×7 (6/1) RHRL	AISI316
S	45 kg	7×7 (6/1) RHRL	AISI316
Y	100 kg	7×7 (6/1) RHRL	AISI316
P	200 kg	7×19 (6/1) RHRL	AISI316
N	450 kg	7×19 (6/1) RHRL	AISI316

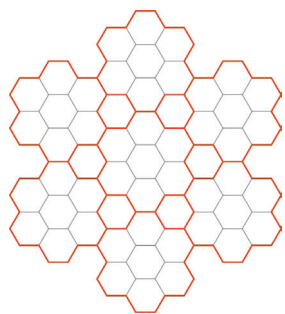

▲ Construction of 7×7 wire rope.

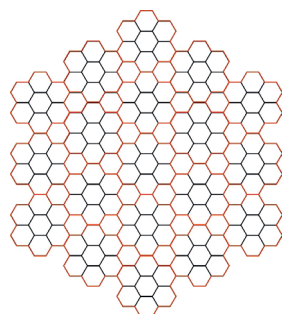

▲ Construction of 7×19 wire rope.

WEIGHT LOAD CALCULATIONS

When calculating weight loadings for suspensions it is important to adhere to industry standards:

- For cable management systems, cable ladder, cable tray and cable basket refer to IEC 61537 (Cable Tray and Ladder Standard) used in conjunction with the manufacturers independent load testing.
- For HVAC industry refer to DW144 Part 6 – Hangers and supports.

Selecting the correct solution requires:

1. Identification of the substrate,
2. The length of the wire suspension (the drop),
3. The overall weight per metre or per plant item to be suspended.

The wire to be used is identified by applying the formula:

Weight per metre × Distance between hangers

Examples: 12 kg per metre fixed at 2 m centres – 12 × 2 = 24 kg
S rated wire @ 50 kg (galvanised mild steel)

65 kg per metre fixed at 1.5 m centres – 65 × 1.5 = 97.5 kg
Y rated wire 120 kg (galvanised mild steel)

Angular Performance

The table below shows the effect on Safe Working Load when a system is working at an angle from the vertical.

Wire Code	Vertical	15°	30°	45°	60°
G	15 kg	14.40 kg	12.9 kg	10.5 kg	7.5 kg
S	50 kg	48 kg	43 kg	35 kg	25 kg
Y	120 kg	115.2 kg	103.2 kg	84 kg	60 kg
P	300 kg	288 kg	258 kg	210 kg	150 kg
N	500 kg	480 kg	430 kg	350 kg	250 kg
LOAD	100%	96%	86%	70%	50%



ENVIRONMENTAL BENEFITS OF WIRE ROPE

A case study:

A typical retail store uses approximately 1,200 suspension drops at 2 m (i.e. 2,400 metres in total).

M8 rod would weigh 748.80 kg and produce 1,344 kg of CO₂ to manufacture the 2,400 metres required.

A Zip-Clip wire rope system would weigh 37.86 kg and produce 96 kg of CO₂ to manufacture the 2,400 metres.

- Saving on weight: 710 kg
- Saving on CO₂: 1,248 kg

Therefore a 92.6% reduction of CO₂ emission can be realised by utilising a Zip-Clip wire rope Suspension System and this major environmental benefit does not take into account transportation!

Data provided by the Worldwide Lifecycle Inventory Methodology Report 1999/2000.

INTRODUCTION TO THE RIZE SYSTEM

The Zip-Clip Rize system is a highly versatile system that consists of wire rope, supplied on reels in dispensing boxes, and corresponding Zip-Clip locking devices. The system is designed to give installers the flexibility to custom fit desired drop lengths on site for both lightweight or heavy-duty installations.

Zip-Clip devices are utilised to anchor the wire rope to a ceiling or anchor point, as well as being used to attach the wire to the desired fixture or fitting.

AVAILABILITY

Five different Rize systems are available, each allocated a letter to differentiate between safe working loads (SWL).

System	Device	Wire Rope	SWL (kg)
G	KL50	R200G	15
S	KL100	R100S	50
		R200S	
		R500S	
Y	KL150	R100Y	120
P	KL200	R100P	300
N	KL600	R100N	500

Loads indicated are per individual wire support when coupled with the appropriate locking device. A safety factor of 5:1 is applied to all SWL figures.

Note: G-system not recommended for use with HVAC.

ZIP-CLIP RIZE – HOW IT WORKS

The Standard Device

- Pass the wire rope through the locking device in the direction of the arrow.
- Loop the wire rope through or around the anchor point.
- Pass the wire rope back through the device allowing 15 cm of wire rope protruding.
- Apply tension.
- Confirm engagement of the locking device on the wire rope by pushing the adjustment pin in the opposite direction of the arrows indicated on the side of the device.

Zip-Clip devices are also available in a lockable version offering a more secured method of wire rope suspension.

FEATURES AND ADVANTAGES

- High tensile galvanised mild steel or 316 marine grade stainless steel wire rope with 7×7 or 7×19 construction.
- Safety factor of 5:1.
- Fully metallic locking device (zinc alloy main body).
- Key-free release mechanism on each device for easy adjustment.
- Ideal for both short drop lengths in small void spaces and for very long wire supports.
- Easy to transport and store – 100 m coil of wire is equivalent to 30 × 3 m lengths of threaded rod!
- Easy, safe and time efficient to install even in confined spaces – Only wire cutters being required.
- Can be used as a wrap-around solution for applications such as I-beams or purlins.
- Can be used in conjunction with a number of different brackets or fixings, including eye bolt adapters, concrete eye bolts, rib-deck fixings, purlin clips.
- Low visual impact (also available in black).

SUITABLE FOR

- Electrical containment
- HVAC and mechanical installations
- Signage and displays
- Acoustic panel and radiant heat panel suspension
- Bracing
- Catenaries

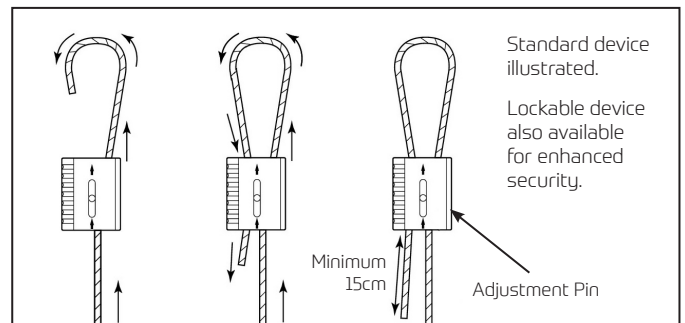

THE FLEXIBILITY OF A ZIP CLIP RIZE DEVICE

Due to the unique way in which the Zip-Clip device is manufactured, each channel can be utilised in different ways to perform a number of different functions.

Each locking channel within a Zip-Clip device works independently of the other. This allows a Zip-Clip to be used in a variety of different ways.

1 Clip Top and Bottom

Zip-Clip's RIZE system offers the flexibility to customise your own drop lengths and is ideal for long drops with no limit on length.

A device is used to anchor the wire rope to the soffit/ceiling structure and another to attach to the fixture/application.

2 All-Round Loop

A Zip-Clip device can be used to create an all-round loop by joining two free ends of wire rope together. This can be coupled with a fixing or fixings of choice in order to create one full suspension.

- Cut double the length of wire rope required for the final drop length.
- Pass or feed one end of wire rope around your chosen anchor point and return this wire rope into one locking channel of the device. Ensure the exit tail is 15 cm.
- Take the other end of wire rope and pass/feed this around your chosen fixture/application, returning the wire rope back into the other available locking channel. Ensure the exit tail is 15 cm.

3 In-Line Joint

By following the arrows on each side of the Zip-Clip device, an in-line joint can be created. This can be used to extend a drop length that is too short. Ensure the exit tails are 15 cm.

4 Stop-End for Trapeze Brackets

As each Zip-Clip device has a flat face across its smallest axis, it can be used as a stopper unit by feeding the wire rope through just one channel. Adjustment can be made by the key-free release mechanism.

By incorporating an optional penny washer/channel nut above each device, the supporting surface area can be increased.

This method is ideal for multi-tier trapeze drops offering a quick, cost-effective and simple solution which can be used in two different guises, see diagram.

Installers must ensure that 10-15 cm of wire rope exits through the back of each device once locked off, known as the dead wire.

All supports must be used within the safe working load.

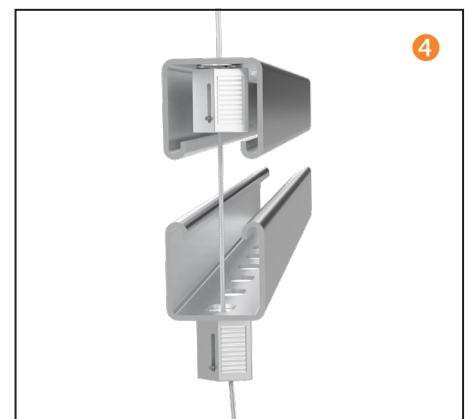
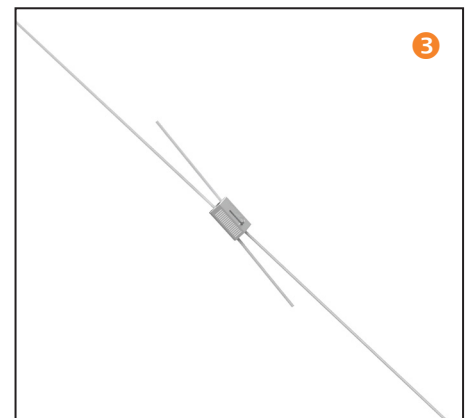
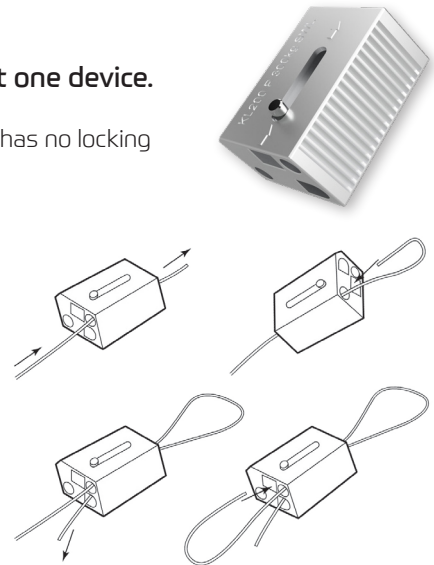

FIGURE OF EIGHT SUSPENSION

The KL200 can be used to make a figure of eight suspension, using just one device.

- Insert the wire rope into the “through-hole” of the KL200. Note, this through-hole has no locking wedge inside it. The wire rope will move freely through this hole.
- Wrap the wire rope around your chosen anchor point and return it back into the KL200 using the available locking channel. Ensure the exit tail is 15 cm.
- Always confirm engagement of the Zip-Clip device on the wire rope by pushing the adjustment pin in the opposite direction of the arrows indicated on the side of the Zip-Clip device.
- Repeat this process with the other end of wire rope.
- Wrap the wire rope around your chosen fixture/application and return the wire rope back into the KL200 using the available locking channel. Again, ensure the exit tail is 15 cm.



MANUFACTURERS RECOMMENDATIONS

Zip-Clip suspension systems are designed to support **STATIC loads only**.

Dynamic and shock loads must be avoided as they can greatly increase the overall effective load of the product being suspended and therefore compromise the safe working load of the suspension. To ensure integrity and safety of the system only Zip-Clip wire rope should be used.

- Do not exceed the safe working load (SWL) of the product.
- Do not use locking devices with a coated wire rope.
- Do not paint or apply any other coating.
- Do not lubricate.
- Do not use for lifting applications.
- Remove any frayed cable prior to inserting into locking devices.
- Do not shock load.
- Do not use for dynamic loads/installations.
- Do not overload.
- Do not mix Zip-Clip systems with other wire rope suspension manufacturers products.
- Do not use in corrosive environments, e.g. chlorinated environments – For specialist applications, such as corrosive environments, please contact Zip-Clip Technical Department.



INSTALLATION FACTORS

Installers must pay attention to the nature of the installation process. Certain installations, such as cable pulling, will introduce dynamic forces onto the supports. Where this might be the case, it is advised to select heavier duty systems.

Ball Strikes – Where this may be a potential factor, such as installations within sports halls, heavier duty wire rope supports should be utilised to offer maximum resistance to dynamic shock loads. Zip-Clip cannot guarantee its systems against the effects of ball strikes.



THE STRUT-LOCK SYSTEM



FEATURES

- Versatile – Use with channel nuts or nuts and washers (metric only).
- Compatible with 41×41 and 41×21 profile channels plus other channel types when compatible channel nuts are used (metric only)
- Quick to install and adjust.
- Secure lock-off.
- High tensile galvanised steel wire rope.
- Manufactured from mild steel.
- Bright zinc plate finish.

AVAILABILITY

Strut-Lock systems are available in drop lengths of 1 m to 10 m. Loads indicated are per individual wire support when coupled with the appropriate Zip-Clip locking device.

Zip-Clip offer two different Strut-Lock systems, the M8 version with a safe working load (SWL) of 45 kg and the M10 with a SWL of 90 kg per wire suspension.

Both systems have a safety factor of 3:1.

THE M8 AND M10 STRUT-LOCK SYSTEMS are used to support HVAC and M&E services from the S-RANGE and Y-RANGE of Zip-Clip wire supports respectively. The devices are typically installed into profile channel which can then be hung from a wire suspension.

APPLICATIONS

SUITABLE AREAS OF USE INCLUDE, BUT ARE NOT LIMITED TO:

- Electrical containment
- HVAC and mechanical services
- Single-tier trapeze brackets
- Multi-tier trapeze brackets
- Attachment to existing bracketry

SYSTEM	WIRE	SUPPLIED STRUT-LOCK DEVICE	SWL (KG)
TPDM820	S	M8	45
TPDM1020	Y	M10	90

Note: Only for static loads that are supported vertically. Always ensure the base material or anchor point are suitable to support the intended load.

FIXING OPTIONS

The M8 and M10 Strut-Lock systems are available with the following fixing terminations:

LOOP END:

To form a choke knot for wrap-around anchor points such as purlins or I-beams. Ensure anchor points are suitable. Product code suffix: TPDM820LPS or TPDM1020LPY.

M6 CONCRETE HAMMER FIXING:

B58539 approved with ETA, offering shallow embedment into cracked and non-cracked concrete. Ensure base material is suitable. Contact Zip-Clip for installation details. Product code suffix: TPDM820CS or TPDM1020CY.

M8 × 60 EYEBOLT:

To couple with female threaded components (metric only). Ensure components are compatible to complete the installation. Product code suffix: TPDM820THS or TPDM1020THY.

Other fixing options are available on request.

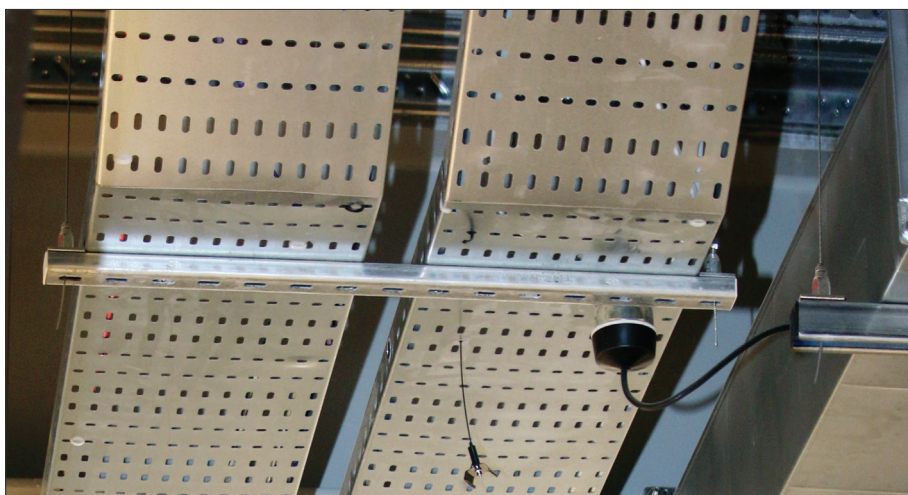

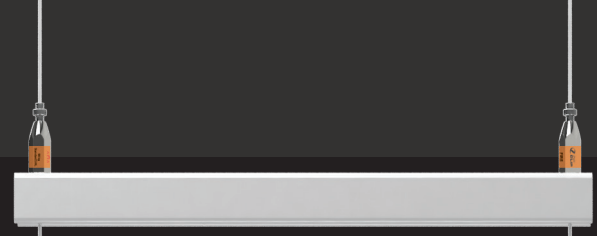

FIRE STRUT-LOCK



THE FIRE STRUT-LOCK is designed to build wire rope suspensions that have resistance to fire.

Fire Strut-Lock utilises stainless steel wire rope which offers optimum performance in fire environments. It can be used to construct single or multi-tiered trapeze bracketry. The male thread of the Fire Strut-Lock can also be coupled with other components such as 90 degree brackets to attach the wire support to other forms of services.

The nature of fire has a dramatic effect on all forms of suspension and it is important to understand that the capability of any suspension system decreases when exposed to fire.

FEATURES

- 90 kg safe working load in ambient conditions.
- Safety factor of 3:1 in ambient conditions.
- Supports loads up to 120 minutes (see load table).
- Secure lock-off.
- All metal construction – no plastic parts.
- Identification label.
- Compatible with channel nut or nut and washer (metric).
- Compatible with standard 41×41 and 41×21 profile channels plus other channel types when compatible channel nuts are used.

APPLICATIONS ... INCLUDE BUT NOT LIMITED TO

- Installations to Edition 18 of the electrical wiring regulations.
- Single-tier and multi-tier trapeze brackets.
- Electrical and mechanical containment suspension.
- HVAC installations/ductwork suspension.
- Signage and displays.
- Installations above fire escape routes.

TESTING

FIRE STRUT-LOCK has been subjected to testing for:

Tensile strength: Conducted by SATRA Technologies UK using UKAS calibrated instruments.

Fire Capability: Conducted by BRE Global UK to British Standard.

STANDARDS FOR FIRE TESTING

Standard fire exposure in accordance with:

- BS476:20 1987** Fire tests on building materials and structures - Part 20: Method for the determination of the fire resistance of elements of construction (general principles), BSI, London, 1987.
- BS EN 13631:2012** Fire resistance tests – Part 1: General requirements, BSI, London 2012.
- DIN 4102 Part 2** Fire behaviour of Building Materials and Components, Building components, Definitions, Requirements and Tests, Deutsche, Berlin, September 1977.

FIRE PERFORMANCE LOADINGS

Safe Working Load (SWL) per wire suspension is 90 kg with 3:1 safety factor in ambient temperatures. Installations built with exact fire performance in mind must utilise the SWL for fire and use the correct amount of supports necessary to hold to loads safely.

EYELET:		
LOAD (kg)	TIME (min)	TEMP (°C)
30	30	842
15	60	945
10	90	1006
10	120	1049
MALE THREAD:		
LOAD (kg)	TIME (min)	TEMP (°C)
40	30	842
18	60	945
10	90	1006
10	120	1049
Note: Loads are per wire suspension.		



PLEASE NOTE:

Only Pressed Eyelet and Pressed M8 Male Thread terminations are approved for use with the Zip-Clip Fire Strut-Lock system as illustrated on page 8 of this document.

TERMINATION OPTIONS (ANCHORING SOLUTIONS)

LOOP-IT SYSTEM



ZIP-LOCK SYSTEM



THE LOOP-IT AND ZIP-LOCK SYSTEMS offer wire rope suspension solutions that can suspend applications from a variety of different anchor points by using a 'choke knot' as the method of fixing, also referred to as a wrap-around system.

The systems are highly flexible in use and can be used to create a non-destructive fixing around an available anchor point, such as a steel purlin, or it can be coupled with other items such as eye-bolts or brackets to suspend from different base materials.

CON-LOCK SYSTEM

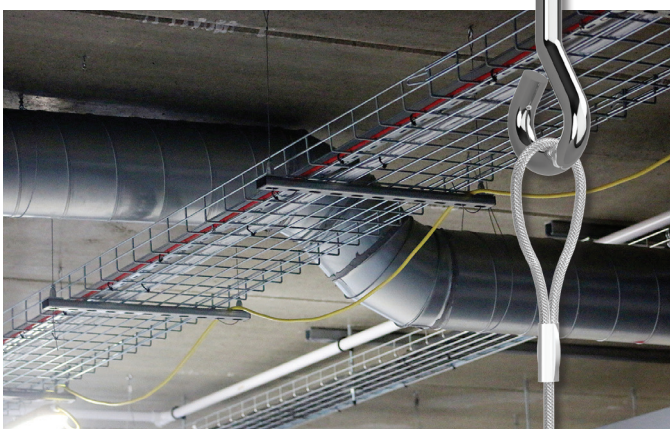

THE CON-LOCK SYSTEM is a wire suspension solution that can suspend applications from a concrete ceiling.

The system consists of an M6 hammer fixing that can be installed into a number of different base materials to provide a strong secure anchor point over head, and a pre-determined length of wire rope supplied complete with an appropriate Zip-Clip locking device.

ANCHOR-IT SYSTEM



THE ANCHOR-IT SYSTEM is a wire suspension solution that can suspend applications from a concrete ceiling.

Each Anchor-It support incorporates a one-piece concrete anchor which is vibration resistant and tamper-proof. The fixing has an "S" shaped configuration which is pre-formed. The pre-expanded mechanism is activated as the anchor is driven into the drilled hole and creates a spring type compression force against the walls of the hole.

TERMINATION OPTIONS (ANCHORING SOLUTIONS) *Continued ...*

THREAD-IT SYSTEM

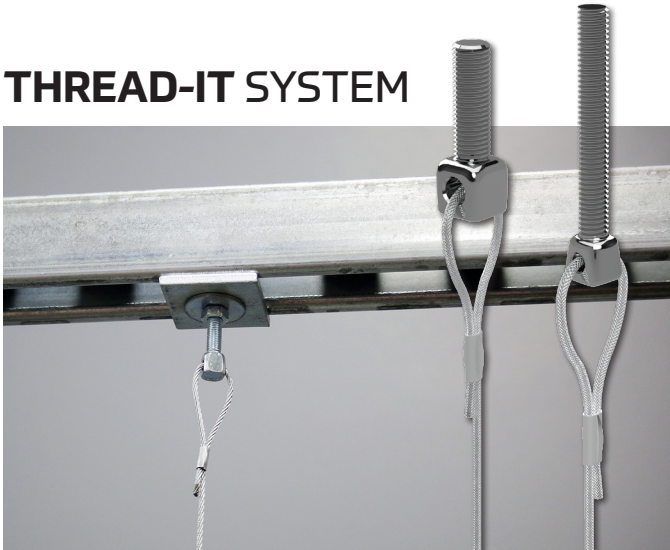

THE THREAD-IT SYSTEM is a wire suspension solution that gives the ability to connect to a number of different base materials.

Each wire suspension comes complete with a male threaded eye bolt (adapter) which can be coupled with a variety of female threaded connections or fixings to give a mechanical fix. It can also be fixed into items that may contain a through-hole.

SHOT-LOCK SYSTEM



THE SHOT-LOCK SYSTEM is designed to fix a wire suspension to a base material using Powder Actuated Tools (PAT).

The suspension consists of a length of wire rope with a shot-fire bracket termination (nail included) and is supplied with an appropriate Zip-Clip locking device.

UNI-LOCK SYSTEM



THE UNI-LOCK SYSTEM is designed to fix a wire suspension to a variety of different base materials including timber, concrete, plasterboard or steel. It incorporates a 90 degree bracket which is factory-swaged to the wire suspension.

A suitable fixing for the intended base material is then used to fix the suspension to the ceiling.

KNOCK-IT SYSTEM



THE KNOCK-IT SYSTEM is a wire suspension solution that can suspend applications from purlin steel work (cold rolled steel) with a vertical flange.

The system consists of a knock-on purlin fixing designed for a specific range of purlin thickness and a pre-determined length of wire rope and is supplied complete with an appropriate Zip-Clip locking device.

DEC-LOCK SYSTEM

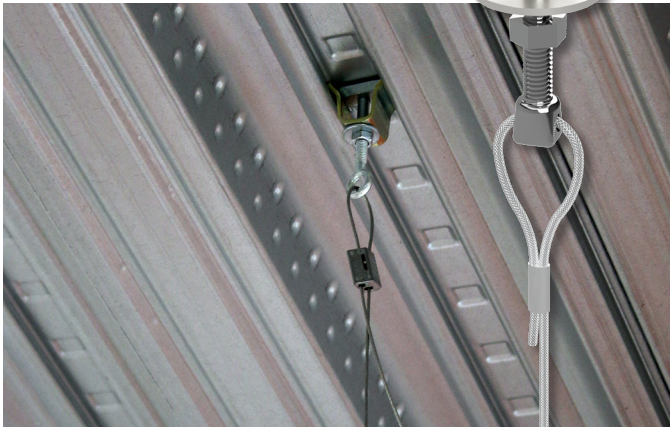

THE DEC-LOCK SYSTEM is a wire suspension solution that will suspend applications from a concrete over rib-deck ceiling. They offer a none-destructive way of anchoring a wire suspension to the base material and utilise specific wedges that are designed to fit into the profile channels that are found running along the underside of the rib-deck. Each Dec-Lock support consists of a deck wedge coupled with an eye bolt adapter, nut and washer along with a pre-determined length of wire rope supplied complete with an appropriate Zip-Clip locking device.



SPAN-LOCK SYSTEM

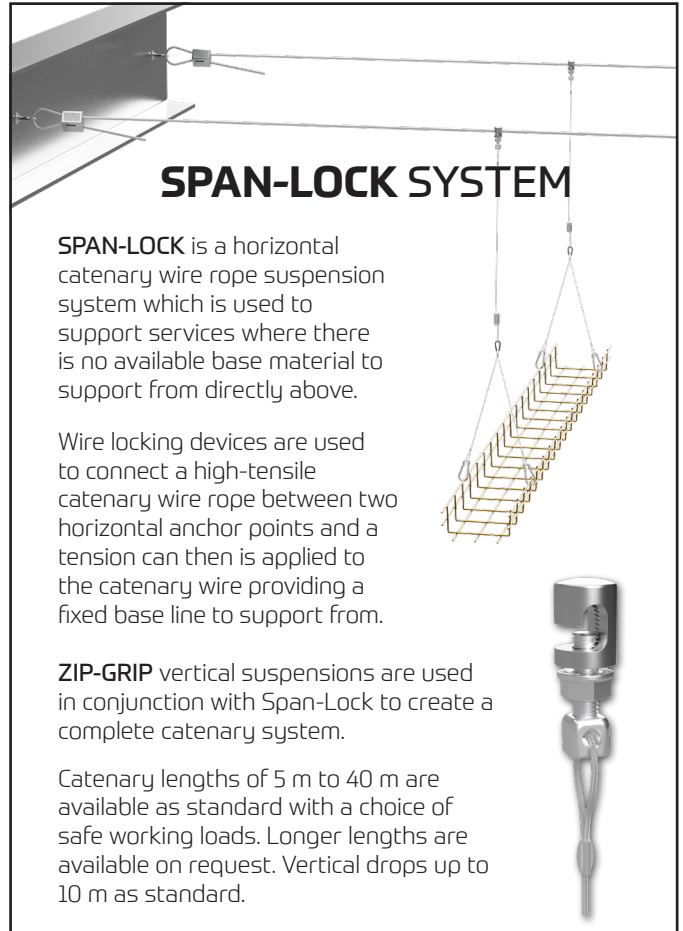

SPAN-LOCK is a horizontal catenary wire rope suspension system which is used to support services where there is no available base material to support from directly above.

Wire locking devices are used to connect a high-tensile catenary wire rope between two horizontal anchor points and a tension can then be applied to the catenary wire providing a fixed base line to support from.

ZIP-GRIP vertical suspensions are used in conjunction with Span-Lock to create a complete catenary system.

Catenary lengths of 5 m to 40 m are available as standard with a choice of safe working loads. Longer lengths are available on request. Vertical drops up to 10 m as standard.

SERVICE TERMINATION OPTIONS

TOGGLE-IT SYSTEM

Solution incorporating a toggle that forms the termination point.



SNAP-IT SYSTEM

Solution incorporating a carabiner that forms the termination point.



Y-IT SYSTEM

Designed to turn one suspension point in the ceiling into two connections points at the service level. Y-It incorporates an inverted Y-Shape design with equal leg lengths that ensures the services are level once installed. Available with either carabiner or toggle termination.



DUCT-LOCK SYSTEM

Utilised to connect a wire rope suspension to rectangular ductwork allowing for suspension of without the need to use a bearer underneath.



TRY-LOCK AND LUMA-LOCK SYSTEMS

Designed to suspend services from a single point suspension. Try-Locks are fitted to the intended application using carabiners whereas Luma-Locks utilise toggles. Both are coupled to a chosen Zip-Clip vertical suspension.



PLUS-ON-WIRE SYSTEM

A wire suspension solution incorporating a locking device that installs into standard profile channel. Used for building heavy-weight trapeze brackets and for supporting modules.



WHERE CAN I USE WIRE?

Applications for Zip-Clip wire rope systems are as varied as your imagination – Zip-Clip solutions give you the freedom to take control. They are the flexible, strong, stylish, high-specification suspension and bracing solution of today and with requirements to reduce the volume of materials utilised on projects, and the need to minimise waste, now more important than ever, there has never been a better time to look at the countless benefits of wire, not to mention reduced transportation and storage costs.

Zip-Clip wire rope suspension and bracing systems ...

Be inspired ... Applications are as varied as your imagination.

If you automatically think of using rigid threaded bars to solve HVAC, electrical, mechanical, signage or other suspension or bracing needs, you may want to think again.

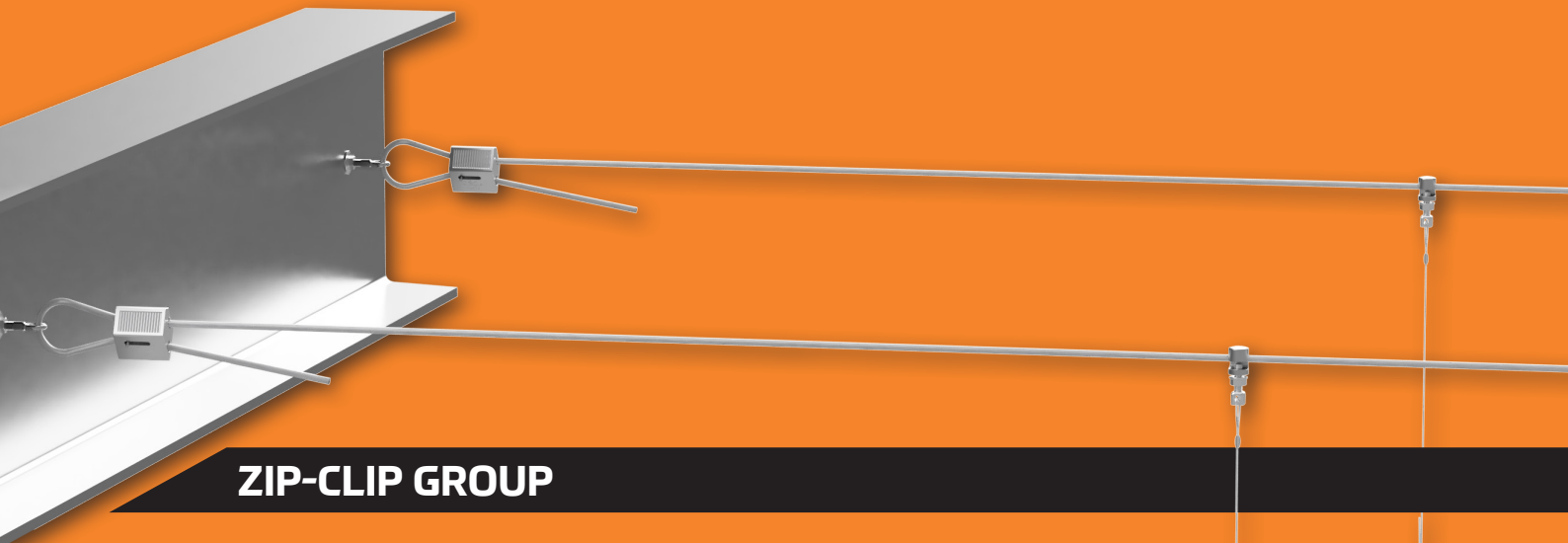

ZIP-CLIP GROUP



United Kingdom HQ
ZIP-CLIP LTD

Tel: +44 (0)1686 623 366

Email: info@zip-clip.com

www.zip-clip.com

Europe
ZIP-CLIP S.A.R.L

Tel: +33 (0)1 87 15 71 91

Email: france@zip-clip.com

www.zip-clip.eu



THE QUEEN'S AWARDS
FOR ENTERPRISE:
INTERNATIONAL TRADE
2019

Australasia
ZIP-CLIP PTY LTD

Tel: +61 (0)431 464 272

Email: sales@zip-clip.com.au

www.zip-clip.com.au

