



Circuit breaker size S2 for motor protection, CLASS 10 A-release 54...65 A N-release 845 A screw terminal Standard switching capacity

product brand name	SIRIUS
product designation	Circuit breaker
design of the product	For motor protection
product type designation	3RV2
General technical data	
size of the circuit-breaker	S2
size of contactor can be combined company-specific	S2
product extension auxiliary switch	Yes
power loss [W] for rated value of the current	
• at AC in hot operating state	26 W
• at AC in hot operating state per pole	8.7 W
insulation voltage with degree of pollution 3 at AC rated value	690 V
surge voltage resistance rated value	6 kV
shock resistance according to IEC 60068-2-27	25g / 11 ms Sinus
mechanical service life (operating cycles)	
• of the main contacts typical	20 000
• of auxiliary contacts typical	20 000
electrical endurance (operating cycles) typical	20 000
type of protection according to ATEX directive 2014/34/EU	Ex II (2) GD
certificate of suitability according to ATEX directive 2014/34/EU	DMT 02 ATEX F 001
reference code according to IEC 81346-2	Q
Substance Prohibitance (Date)	04/10/2015
SVHC substance name	Blei - 7439-92-1
Ambient conditions	
installation altitude at height above sea level maximum	2 000 m
ambient temperature	
• during operation	-20 ... +60 °C
• during storage	-50 ... +80 °C
• during transport	-50 ... +80 °C
relative humidity during operation	10 ... 95 %
Main circuit	
number of poles for main current circuit	3
adjustable current response value current of the current-dependent overload release	54 ... 65 A
operating voltage	
• rated value	20 ... 690 V
• at AC-3 rated value maximum	690 V
• at AC-3e rated value maximum	690 V
operating frequency rated value	50 ... 60 Hz
operational current rated value	65 A

operational current	
<ul style="list-style-type: none"> • at AC-3 at 400 V rated value • at AC-3e at 400 V rated value 	65 A 65 A
operating power	
<ul style="list-style-type: none"> • at AC-3 <ul style="list-style-type: none"> — at 230 V rated value — at 400 V rated value — at 500 V rated value — at 690 V rated value • at AC-3e <ul style="list-style-type: none"> — at 230 V rated value — at 400 V rated value — at 500 V rated value — at 690 V rated value 	18.5 kW 30 kW 45 kW 55 kW 18.5 kW 30 kW 45 kW 55 kW
operating frequency	
<ul style="list-style-type: none"> • at AC-3 maximum • at AC-3e maximum 	15 1/h 15 1/h
Protective and monitoring functions	
product function	
<ul style="list-style-type: none"> • ground fault detection • phase failure detection 	No Yes
trip class	CLASS 10
design of the overload release	thermal
maximum short-circuit current breaking capacity (I_{cu})	
<ul style="list-style-type: none"> • at AC at 240 V rated value • at AC at 400 V rated value • at AC at 500 V rated value • at AC at 690 V rated value 	100 kA 65 kA 8 kA 4 kA
operating short-circuit current breaking capacity (I_{cs}) at AC	
<ul style="list-style-type: none"> • at 240 V rated value • at 400 V rated value • at 500 V rated value • at 690 V rated value 	100 kA 30 kA 4 kA 2 kA
response value current of instantaneous short-circuit trip unit	845 A
UL/CSA ratings	
full-load current (FLA) for 3-phase AC motor	
<ul style="list-style-type: none"> • at 480 V rated value • at 600 V rated value 	65 A 62 A
yielded mechanical performance [hp]	
<ul style="list-style-type: none"> • for 3-phase AC motor <ul style="list-style-type: none"> — at 200/208 V rated value — at 220/230 V rated value — at 460/480 V rated value — at 575/600 V rated value 	20 hp 25 hp 50 hp 60 hp
Short-circuit protection	
product function short circuit protection	Yes
design of the short-circuit trip	magnetic
design of the fuse link for IT network for short-circuit protection of the main circuit	
<ul style="list-style-type: none"> • at 240 V • at 400 V • at 500 V • at 690 V 	none required 160 125 100
Installation/ mounting/ dimensions	
mounting position	any
fastening method	screw and snap-on mounting onto 35 mm DIN rail according to DIN EN 60715
height	140 mm
width	55 mm
depth	149 mm
required spacing	
<ul style="list-style-type: none"> • with side-by-side mounting at the side 	0 mm

• for grounded parts at 400 V	
— downwards	50 mm
— upwards	50 mm
— at the side	10 mm
• for live parts at 400 V	
— downwards	50 mm
— upwards	50 mm
— at the side	10 mm
• for grounded parts at 500 V	
— downwards	50 mm
— upwards	50 mm
— at the side	10 mm
• for live parts at 500 V	
— downwards	50 mm
— upwards	50 mm
— at the side	10 mm
• for grounded parts at 690 V	
— downwards	50 mm
— upwards	50 mm
— at the side	10 mm
• for live parts at 690 V	
— downwards	50 mm
— upwards	50 mm
— at the side	10 mm

Connections/ Terminals

type of electrical connection	
• for main current circuit	screw-type terminals
arrangement of electrical connectors for main current circuit	Top and bottom
type of connectable conductor cross-sections	
• for main contacts	
— solid or stranded	2x (1 ... 35 mm ²), 1x (1 ... 50 mm ²)
— finely stranded with core end processing	2x (1 ... 25 mm ²), 1x (1 ... 35 mm ²)
• for AWG cables for main contacts	2x (18 ... 2), 1x (18 ... 1)
tightening torque	
• for main contacts with screw-type terminals	3 ... 4.5 N·m
design of screwdriver shaft	Diameter 5 to 6 mm
size of the screwdriver tip	Pozidriv size 2
design of the thread of the connection screw	
• for main contacts	M6

Safety related data

proportion of dangerous failures	
• with low demand rate according to SN 31920	50 %
• with high demand rate according to SN 31920	50 %
failure rate [FIT] with low demand rate according to SN 31920	50 FIT
B10 value with high demand rate according to SN 31920	5 000

IEC 61508

T1 value for proof test interval or service life according to IEC 61508	10 a
--	------

Electrical Safety

protection class IP on the front according to IEC 60529	IP20
touch protection on the front according to IEC 60529	finger-safe, for vertical contact from the front
display version for switching status	Handle

Approvals Certificates











General Product Approval



[Confirmation](#)



[KC](#)

General Product Approval	For use in hazardous locations	Test Certificates		Marine / Shipping
			Special Test Certificate	Type Test Certificates/Test Report
				
Marine / Shipping				other
				
				Miscellaneous
other		Railway		
Confirmation		Confirmation		

Further information

Siemens has decided to exit the Russian market (see here).

<https://press.siemens.com/global/en/pressrelease/siemens-wind-down-russian-business>

Siemens is working on the renewal of the current EAC certificates.

Please contact your local Siemens office on the status of validity of the EAC certification if you intend to import or offer to supply these products to an EAC relevant market (other than the sanctioned EAEU member states Russia or Belarus).

Information on the packaging

<https://support.industry.siemens.com/cs/ww/en/view/109813875>

Information- and Downloadcenter (Catalogs, Brochures,...)

<https://www.siemens.com/ic10>

Industry Mall (Online ordering system)

<https://mall.industry.siemens.com/mall/en/en/Catalog/product?mlfb=3RV2031-4JA10>

Cax online generator

<http://support.automation.siemens.com/WW/CAXorder/default.aspx?lang=en&mlfb=3RV2031-4JA10>

Service&Support (Manuals, Certificates, Characteristics, FAQs,...)

<https://support.industry.siemens.com/cs/ww/en/ps/3RV2031-4JA10>

Image database (product images, 2D dimension drawings, 3D models, device circuit diagrams, EPLAN macros, ...)

http://www.automation.siemens.com/bilddb/cax_de.aspx?mlfb=3RV2031-4JA10&lang=en

Characteristic: Tripping characteristics, I²t, Let-through current

<https://support.industry.siemens.com/cs/ww/en/ps/3RV2031-4JA10/char>

Further characteristics (e.g. electrical endurance, switching frequency)

<http://www.automation.siemens.com/bilddb/index.aspx?view=Search&mlfb=3RV2031-4JA10&objecttype=14&gridview=view1>

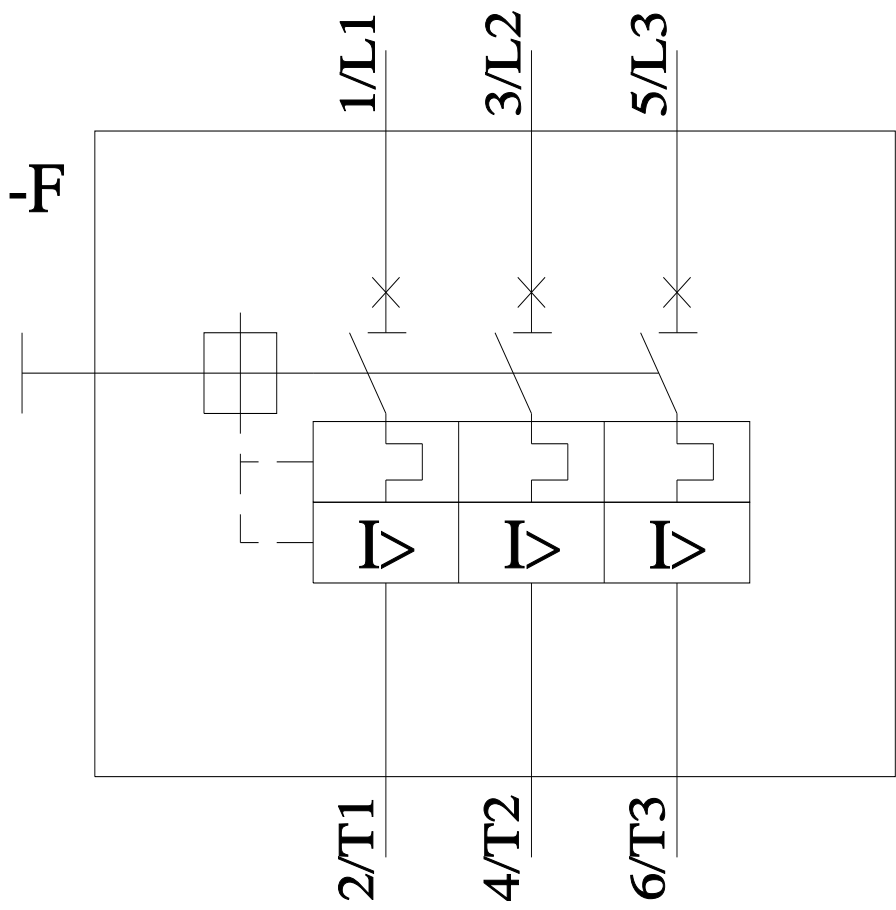
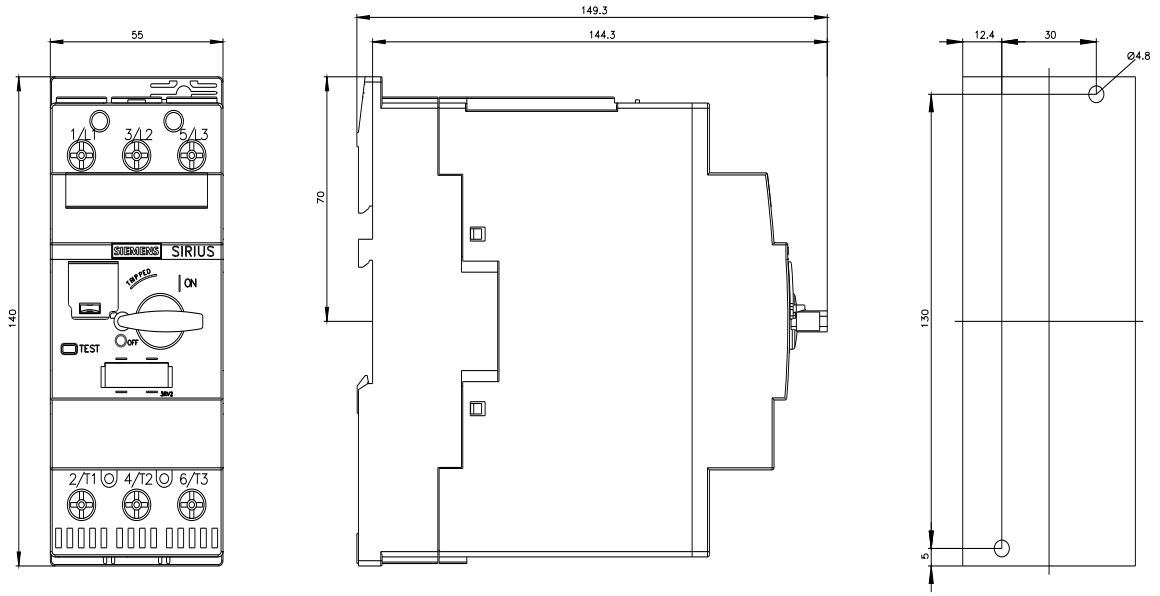

last modified:

9/5/2023

