

PowerLogic™ PM8000 series

User manual

7EN02-0336-08

12/2021



Legal information

The Schneider Electric brand and any trademarks of Schneider Electric SE and its subsidiaries referred to in this guide are the property of Schneider Electric SE or its subsidiaries. All other brands may be trademarks of their respective owners.

This guide and its content are protected under applicable copyright laws and furnished for informational use only. No part of this guide may be reproduced or transmitted in any form or by any means (electronic, mechanical, photocopying, recording, or otherwise), for any purpose, without the prior written permission of Schneider Electric.

Schneider Electric does not grant any right or license for commercial use of the guide or its content, except for a non-exclusive and personal license to consult it on an "as is" basis. Schneider Electric products and equipment should be installed, operated, serviced, and maintained only by qualified personnel.

As standards, specifications, and designs change from time to time, information contained in this guide may be subject to change without notice.

To the extent permitted by applicable law, no responsibility or liability is assumed by Schneider Electric and its subsidiaries for any errors or omissions in the informational content of this material or consequences arising out of or resulting from the use of the information contained herein.

Safety information

Important information

Read these instructions carefully and look at the equipment to become familiar with the device before trying to install, operate, service, or maintain it. The following special messages may appear throughout this manual or on the equipment to warn of potential hazards or to call attention to information that clarifies or simplifies a procedure.



The addition of either symbol to a "Danger" or "Warning" safety label indicates that an electrical hazard exists which will result in personal injury if the instructions are not followed.



This is the safety alert symbol. It is used to alert you to potential personal injury hazards. Obey all safety messages that follow this symbol to avoid possible injury or death.

DANGER

DANGER indicates a hazardous situation which, if not avoided, **will result in** death or serious injury.

WARNING

WARNING indicates a hazardous situation which, if not avoided, **could result in** death or serious injury.

CAUTION

CAUTION indicates a hazardous situation which, if not avoided, **could result in** minor or moderate injury.

NOTICE

NOTICE is used to address practices not related to physical injury.

Please note

Electrical equipment should be installed, operated, serviced and maintained only by qualified personnel. No responsibility is assumed by Schneider Electric for any consequences arising out of the use of this material. A qualified person is one who has skills and knowledge related to the construction, installation, and operation of electrical equipment and has received safety training to recognize and avoid the hazards involved.

Notices

FCC

This equipment has been tested and found to comply with the limits for a Class B digital device, pursuant to part 15 of the FCC rules. These limits are designed to provide reasonable protection against harmful interference in a residential installation. This equipment generates, uses, and can radiate radio frequency energy and, if not installed and used in accordance with the instructions, may cause harmful interference to radio communications. However, there is no guarantee that the interference will not occur in a particular installation. If this equipment does cause harmful interference to radio or television reception, which can be determined by turning the equipment off and on, the user is encouraged to try to correct the interference by one or more of the following measures:

- Reorient or relocate the receiving antenna.
- Increase the separation between the equipment and receiver.
- Connect the equipment to an outlet on a circuit different from that to which the receiver is connected.
- Consult the dealer or an experienced radio/TV technician for help.

The user is cautioned that any changes or modifications not expressly approved by Schneider Electric could void the user's authority to operate the equipment.

This digital apparatus complies with CAN ICES-3 (B) /NMB-3(B).

Open source software components

This Schneider Electric product is provided with certain open source software components (collectively, "OSS") developed by third parties. Refer to "Open source software components" on page 277 for details.

About this manual

This manual discusses features of the PowerLogic™ PM8000 series power meter and provides configuration instructions.

Throughout the manual, the term “meter” refers to all models of the PowerLogic™ PM8000 series meter. All differences between the models, such as a feature specific to one model, are indicated with the appropriate model number or description.

This manual assumes you have an understanding of power metering and are familiar with the equipment and power system in which your meter is installed.

This manual does not provide configuration information for advanced features where an expert user would perform advanced configuration. It also does not include instructions on how to incorporate meter data or perform meter configuration using energy management systems or software, other than ION Setup. ION Setup is a free configuration tool available for download from www.se.com.

Contact your local Schneider Electric representative to learn what additional training opportunities are available regarding the PowerLogic™ PM8000 series meter.

Make sure you are using the most up-to-date version of your meter’s firmware in order to access the latest features.

The most up-to-date documentation about your meter is available for download from www.se.com.



Related documents

Document	Number
PowerLogic™ PM8000 online documents	https://www.se.com/ca/en/product-range/62252-pm8000-series/#documents
PowerLogic™ PM8000 series - MID/MIR installation guide	NHA99708
PowerLogic™ PM8000 series - Panel Mount installation guide	EAV47343
PowerLogic™ PM8000 series - DIN Mount installation guide	EAV47344
ION Reference	7EN02-0290
ION device template reference	–

Document	Number
PowerLogic™ PM8000 series technical datasheet	PLSED310058EN
PowerLogic™ Fiber Ethernet option module	METSEPMFIBER
PowerLogic™ 4-wire RS-485 option module	METSEPMRS4854W

Table of Contents

Safety information	3
Notices	4
Table of Contents	7
Safety precautions	16
Meter overview	18
PM8000 series overview	18
Your meter in an energy management system	19
Communications	19
Supported protocols	19
Meter configuration	19
ION Setup device configuration tool	19
Switching ION Setup to Advanced mode	20
Data display	20
Built-in web server and webpages	20
Localization	20
Display	20
Notification	20
Active and historical alarms	20
Email notifications	21
PM8000 meter models and accessories	21
Mounting adaptors	22
Terminal covers	22
Cybersecurity	23
Cybersecurity overview	23
Recommended actions	23
Plan	26
Cybersecurity awareness	27
System defense-in-depth assumptions	27
Device security capabilities	28
Security risks and mitigation strategies	31
Configure	32
Meter security configuration	32
Disabling and enabling protocols and changing port numbers	42
Verifying the meter security settings	42
Viewing the Device Configuration Checklist	44
Applying security settings to multiple meters	44
Updating passwords on multiple meters	45
Default meter security settings	46
Advanced security mode	47
Operate	50
Monitoring the event log	50

Reporting a security incident or vulnerability	50
Maintain	50
Viewing and downloading an event log	51
Upgrades and security configuration	51
Decommission	51
Wiping the device	52
Overwriting the meter template file	53
Restoring default security configuration	54
Overwriting factory module registers	54
Overwriting communication module registers	54
Disposal, reuse, recycling	55
Installation and commissioning	57
Installation	57
Power system wiring	58
Residual current measurement	58
Option modules	58
Maximum number of option modules	59
Panel-mount meter and remote display mounting and wiring recommendations	60
Commissioning	60
Factory default settings	60
Commissioning using ION Setup	61
Configuring metering parameters	61
Using the Phasor Viewer	62
Basic setup using the webpages or display	62
Communications	64
Communications overview	64
Ethernet communications	64
Ethernet communications connections	64
Protocols, ports, and connections	65
Self-discovery over Ethernet	66
Ethernet configuration	67
DHCP	77
Meter domain name	78
Network protocol control	78
Serial communications	80
RS-485	81
RS-485 wiring	81
RS-485 configuration	81
Disabling serial communications ports	85
ION	86
Modbus	86
Key terms	87
Modbus best practices for Ethernet	87
Modbus best practices for serial	88

Your meter as a Modbus master	88
Your meter as a Modbus slave	91
Supported Modbus features	93
Modbus implementation	94
Modbus map	96
Configuring custom Modbus data using ION Setup	97
Ethernet gateway	98
EtherGate	99
Modbus Ethernet gateway	101
Creating an Ethernet gateway site using ION Setup	102
HTTPS	103
Changing web protocol settings using ION Setup	104
Secure website indicator	104
Default SSL certificate and webpages security	104
Uploading a custom SSL certificate	104
Generating a new self-signed SSL certificate	105
Deleting a custom SSL certificate	105
Secure File Transfer Protocol (SFTP)	105
Transferring files using SFTP	105
Free up flash memory	106
SFTP folders and file permissions	106
SFTP filename requirements	106
Simple Network Management Protocol (SNMP)	106
Key terms	107
Your meter in an SNMP system	107
SNMP trapping	108
Configuring SNMP using ION Setup	108
Configuring SNMP using webpages	109
SNMP implementation	110
Default SNMP mapping	112
Configuring SNMP MIB files	112
IEC 61850	114
Mapping additional data to IEC 61850	114
Enabling IEC 61850 functionality	114
Configuring digital outputs for IEC 61850 control	116
Deleting an IEC 61850 configuration file	117
Distributed Network Protocol (DNP)	117
DNP supported features and default implementation	117
Inputs/Outputs	118
Inputs/Outputs overview	118
Input/output ION modules	118
Input/output ION modules, ports, and labels	119
Factory configured settings	119
I/O option modules	120

Viewing I/O option module data	121
I/O option module configuration	121
Analog inputs	122
Analog input applications	122
Analog input voltage and current mode	122
Analog input behavior	122
Analog input zero scale and full scale values	122
Configuring option module analog inputs using ION Setup	123
Analog outputs	124
Analog output applications	124
Analog output behavior	124
Analog output zero scale and full scale values	124
Configuring option module analog outputs using ION Setup	125
Digital inputs	125
Digital input applications	125
IRIG-B time synchronization	126
Configuring onboard digital inputs using ION Setup	127
Configuring option module digital inputs using ION Setup	127
WAGES monitoring	128
Input metering	129
Digital outputs	131
Digital output applications	131
Configuring onboard digital outputs using ION Setup	132
Configuring option module digital outputs using ION Setup	132
Energy pulsing	133
Default energy pulsing LED sources	133
Configuring LED energy pulsing using ION Setup	134
Configuring digital output energy pulsing using ION Setup	135
Calculate your maximum kWh/pulse (pulse weight) value	136
Webpages	137
Webpage interface	137
Default meter webpages	137
Accessing webpages for data viewing and meter configuration	139
Embedding images and files in meter webpages	140
Creating custom webpages	140
Deleting custom webpages	141
Loading webpages using ION Setup	141
Loading webpages using SFTP	141
Sample data viewing webpage	142
Sample webpage data viewing result	142
Sample HTML code for data viewing webpage content	144
Sample setup webpage	147
Sample HTML code for setup webpage content	149
Display	153

Display overview	153
Home button	153
Revenue lock icon	154
Alarm icon	154
Alarm and status LED indicators	154
Navigation symbols	155
Using the onscreen keyboard	156
More screens access	157
Overrange indication	157
Auto-scaling feature	157
Display screens	158
Display menu	158
Data display screens	158
Setup menu	159
Meter setup using your display	160
Display setup	162
Language setup	163
Creating custom displays using ION Setup	163
Remote display troubleshooting icons	164
Alarms and alerts	165
Alarms	165
Alarm types	165
Standard and high-speed alarms	165
Relative setpoint	168
Sag/swell alarms	168
Digital alarms	168
Alarm event priorities	168
Alarm indicators	169
Default alarms	170
Alarm information	171
Viewing and acknowledging alarms using the display	171
Alarm configuration	171
Alerts	177
Setpoint learning	178
Learning installation mode and learning duration	178
Implementing standard alarm setpoint learning using ION Setup	179
Implementing sag and swell limit learning using ION Setup	180
Power quality	182
Power quality configuration	182
Power quality logging	183
Sags and swells	183
Configuring Advanced Power Quality	185
Harmonics	187
Viewing harmonics information using the display	188

Voltage crest factor	188
Current crest factor	188
K-factor	188
Harmonic content calculations	189
THD% calculations	189
thd and TDD	189
Phasors	189
Power quality standards compliance	190
IEC 61000-4-30	190
EN 50160	190
IEEE 519	190
IEC 60255-24 (COMTRADE)	191
Disturbance direction detection overview	191
Disturbance direction detection events	192
COMTRADE	192
COMTRADE implementation	192
Waveforms on the meter webpages	193
Viewing waveforms on meter webpages	194
Burst data logging	196
Data recorder burst data	196
Waveform capture	197
Standard waveform capture	197
Delayed waveform capture	198
Extended waveform capture	199
Logging	202
Logging overview	202
Default data logging configuration	202
Revenue log	202
Historic data logs	203
Loss log	204
Harmonics logs	204
Energy and demand log	205
Daily nominal log	205
Sag/swell log	205
Sg/Sw HS log	206
EN 50160 compliance logs	206
IEC 61000-4-30 compliance logs	206
IEEE 519 compliance logs	208
Configuring data logging using ION Setup	208
Waveform recording	209
Waveform data storage format	209
Types of waveform data	209
Key terms	210
Default waveform recording configuration	210

Waveform Recorder modules	210
COMTRADE modules	211
Event log	211
Default event log configuration	211
Syslog	212
Configuring Syslog network settings using ION Setup	213
Syslog severity to event log priority mapping	213
Advanced log setup and memory optimization	214
Viewing log configuration and memory usage information	214
Log depth configuration	214
Log interval configuration	214
Log mode configuration	215
Log buffer configuration	216
Changing log interval and depth settings using ION Setup	219
Time and timekeeping	221
Time and timekeeping overview	221
Internal clock temperature compensation	221
Time synchronization	221
Supported time synchronization sources	222
Clock source	222
Clock source time quality flag	223
PTP system setting recommendations	223
Star network topology	224
Configuring time information using ION Setup	225
Configuring time information using the display	227
Measurements	229
Energy	229
Demand	229
Instantaneous measurements	229
Harmonics	229
Min/max recording	230
Power quality	230
Power and power factor	230
Power factor (PF)	231
Apparent, active, and reactive power (PQS)	231
Current phase shift from voltage	232
Power demand	233
Peak demand	234
Peak demand reset lockout	234
Sliding window demand	234
Examples of sliding window demand	234
Incremental energy	235
Example: Incremental energy	236
Configuring incremental energy using ION Setup	236

Conditional energy	237
Configuring conditional energy using ION Setup	237
Trending and forecasting overview	238
Trending and forecasting implementation	238
Viewing trending and forecasting data on your meter's webpages	238
Resets	240
Resets overview	240
Option modules reset	240
Available resets	240
Resetting the meter using ION Setup	241
Resetting the meter using the meter webpages	242
Resetting the meter using the display	243
Firmware upgrades	246
Firmware upgrades overview	246
Obtaining meter upgrades	246
Upgrade information	246
Meter firmware	246
Restart requirement	246
Legacy security support	247
Meter firmware upgrade prerequisites	247
Back up custom meter webpages	247
Back up custom meter frameworks	248
Back up accumulated energy values	248
Download latest ION Setup	248
Connection requirements	248
Meter firmware upgrades	248
Option 1 (recommended) – Upgrading using ZIP file	249
Option 2 – Upgrading using individual upgrade files	251
Status	251
Upgrading display firmware	251
Upgrading option module firmware	251
Loading option module firmware using ION Setup	252
Loading option module firmware using SFTP	253
Maintenance	254
Maintenance overview	254
Editing accumulated energy values using ION Setup	254
Device-specific information	254
Revenue	256
Revenue metering components	256
Revenue firmware security features	256
Protected features and settings	256
Revenue locking	256
Revenue-locking summary	257

Revenue lock switch	257
Revenue lock LED behavior	257
Revenue locking your meter	258
Anti-tamper sealing	258
PT/CT correction	259
Time of use	259
Energy pulsing LED behavior	259
Verifying accuracy	260
Verifying accuracy overview	260
Accuracy test requirements	260
Signal and power source	260
Control equipment	260
Environment	261
Reference device or energy standard	261
Energy pulsing	261
Verifying accuracy test meter settings	262
Verifying accuracy test	262
Calculate the number of required pulses	263
Percentage error calculation for accuracy verification testing	264
Typical sources of test errors	264
Accuracy verification test points	265
Troubleshooting	266
Setting up Advanced security troubleshooting	266
Option module troubleshooting	267
Technical assistance	268
PM8000 specifications	269
Mechanical characteristics	269
Mechanical compliance	269
Electrical characteristics	269
Environmental characteristics	272
LEDs	272
EMC (electromagnetic compatibility)	273
Safety	273
Ethernet communications	273
RS-485 communications	274
Real-time clock	274
MID/MIR	274
Display	275
Option modules	275
Other	276
Open source software components	277

Safety precautions

Installation, wiring, testing and service must be performed in accordance with all local and national electrical codes.

DANGER

HAZARD OF ELECTRIC SHOCK, EXPLOSION OR ARC FLASH

- Apply appropriate Personal Protective Equipment (PPE) and follow safe electrical work practices. See NFPA 70E, CSA Z462 or other local standards.
- Turn off all power supplying this device and the equipment in which it is installed before working on or in the equipment.
- Follow guidelines in the Wiring section of the related Installation Guide.
- Always use a properly rated voltage sensing device to confirm that all power is off.
- Do not use the data from the meter to confirm power is off.
- Do not exceed the maximum ratings of this device.
- Do not short secondary terminals of Voltage Transformer (VT).
- Do not open secondary terminals of Current Transformer (CT).
- Ground secondary circuit of CTs.
- Do not install CTs in equipment where they exceed 75% of the wiring space of any cross-sectional area in the equipment.
- Do not install CTs in areas where ventilation openings may be blocked or in areas of breaker arc venting.
- Do not install CTs using Class 2 wiring methods or connect to Class 2 equipment. See NFPA 70.
- Secure CT secondary conductors to ensure they do not contact live circuits.
- Assume communications and I/O wiring are hazardous live until determined otherwise.
- Replace all devices, doors and covers before turning on power to this equipment.

Failure to follow these instructions will result in death or serious injury.

NOTE: See IEC 60950-1 for more information on communications and I/O wiring connected to multiple devices.

WARNING

UNINTENDED OPERATION

Do not use this device for critical control or protection of persons, animals, property, or equipment.

Failure to follow these instructions can result in death, serious injury, or equipment damage.

WARNING

POTENTIAL COMPROMISE OF SYSTEM AVAILABILITY, INTEGRITY, AND CONFIDENTIALITY

- Change default passwords/passcodes to help prevent unauthorized access to device settings and information.
- Disable unused ports/services and default accounts, where possible, to minimize pathways for malicious attacks.
- Place networked devices behind multiple layers of cyber defenses (such as firewalls, network segmentation, and network intrusion detection and protection).
- Use cybersecurity best practices (for example: least privilege, separation of duties) to help prevent unauthorized exposure, loss, modification of data and logs, interruption of services, or unintended operation.

Failure to follow these instructions can result in death or serious injury or equipment damage.

Meter overview

PM8000 series overview

The PM8000 energy and power quality meters help meet the needs of your energy monitoring and cost management applications.

PM8000 meters comply with international metering accuracy standards. You can customize your meter by loading specialized frameworks, adding option modules and incorporating mounting accessories into the physical installation.

Meter features

Power quality readings (THD)
Sag/swell capture for voltage and currents
True RMS metering to the 63rd harmonic
Active (kW), reactive (kVAR) and apparent (kVA) power
600 V direct connection on voltage inputs
Minimum/maximum readings of metered data
Water Air Gas Electricity Steam (WAGES) support
Time of use support
Trending and forecasting
Time synchronization to 1 ms accuracy
Dual port Ethernet (two physical ports, one Ethernet IP address)
Multiple languages supported
Web interface
Configuration through integrated or remote display
Alarms (active and historic) display viewing and acknowledgment
Modbus master and Ethernet gateway protocols supported
Downloadable firmware and templates
Advanced security
Variety of industry-standard communications protocols supported

Account management

If your meter's user access information is lost, the meter is inoperable and cannot be returned to the factory.

NOTICE

DATA LOSS

Record your device's user and password information in a secure location.

Failure to follow these instructions can result in loss of data.

Your meter in an energy management system

As a key piece in your energy management system, the PowerLogic™ PM8000 series meter provides highly accurate measurements and calculations for a wide variety of power system values, performs analysis on collected data, alerts you of potential issues and integrates with a variety of display and analysis software.

It performs analysis on collected data, alerts you of potential issues and integrates with a variety of edge control software such as EcoStruxure™ Power Operation and EcoStruxure™ Power Monitoring Expert, and cloud-based energy management software such as EcoStruxure™ Energy One Hub.

For further analysis, you can also connect your meter with EcoStruxure™ Power Advisor to enhance the performance and maintenance of power networks.

Communications

Supported protocols

Your meter's fundamental protocol and architecture is ION.

You can integrate the meter into various industry-standard networks. Data that the meter measures can be made available to other devices using:

- Modbus
- DNP 3.0
- SNMP

You can configure the meter to import data from other devices on these networks. Your meter supports the IEC 61850 protocol and COMTRADE waveform data format.

Your meter also supports IPv6, DPWS and RSTP Ethernet protocols.

Meter configuration

ION Setup device configuration tool

ION Setup is a free configuration tool for your meter that lets you remotely configure your meter's features over Ethernet or serial communications.

- Use the setup screens to guide you through the process of configuring your meter.
- Use the real-time data screens to verify your meter's configuration.
- Use the data screens to view your meter's recorded data.
- Use the charting function to view your meter's recorded waveforms.
- Use ION Setup in Advanced mode to work directly with modules.

Download ION Setup from www.se.com.

Switching ION Setup to Advanced mode

1. Open ION Setup.
2. Ctrl + click on the meter to select it. This switches ION Setup to Advanced mode.

Data display

Built-in web server and webpages

Your meter's onboard internal web server and built-in webpages provide quick and easy access to real-time energy, basic power quality information and meter configuration without having to use specialized software.

Localization

The meter can be customized to use different regional settings.

Localization settings determine:

- The language used for the display and webpages
- Time, date, and digit formats
- Displayed phase labels (123/ABC)
- Institute of Electrical and Electronics Engineers (IEEE) or International Electrotechnical Commission (IEC) conventions for power, power factor, and energy

Configure your meter's localization settings using ION Setup or the display.

Display

Use the meter's display for local monitoring and standalone applications.

The color LCD display lets you view real-time values, events and alarms, and perform basic device configuration. Connect a remote display to a meter without an integrated display to view meter data and perform basic meter configuration.

Notification

Active and historical alarms

The meter's display shows an alarm icon and the alarm LED flashes if your meter detects an active alarm condition.

Depending on the priority of the alarm, the display also flashes. You can view and acknowledge active alarms, historic alarms, and events using the display and webpages.

An active alarm becomes a historic alarm when the alarm condition no longer exists.

Email notifications

Configure your meter to automatically email information such as notification of a high-priority event or a regularly scheduled send of logged data.

Specify the type of event that triggers an email alert, such as a power quality disturbance or interval for logged data. Email messages from your meter are received like any other email message.

PM8000 meter models and accessories

Commercial references for the PM8000 series meter and accessories.

Commercial reference	Description
METSEPM8240	Panel-mounted meter with integrated display
METSEPM8280	
METSEPM8210	Same as the PM8240, except with low-voltage DC control power
METSEPM82401	Same as the PM8240, except the meter is calibrated to comply with the Measuring Instruments Directive (EU) / Measuring Instruments Regulations (UK) (MID/MIR)
METSEPM82403	Same as the PM8240 with the addition of a sealable hardware lock which prevents modification of revenue related settings and functions. Meter is not sealed. Available to Canada only.
METSEPM82404	Same as the PM8240 with the addition of a sealable hardware lock which prevents modification of revenue related settings and functions. Meter is physically sealed at the factory. Available to Canada only.
METSEPM8243	DIN rail-mounted meter without display, which can be connected to a remote display
METSEPM8213	Same as the PM8243ION7403, except with low-voltage DC control power
METSEPM8244	DIN rail-mounted meter packaged with a remote display
METSEPM8214	Same as the PM8244, except with low-voltage DC control power
METSEPM89RD96	Remote display (for DIN meter only)
METSEPM89M2600	Digital I/O option module (2 outputs, 6 inputs)
METSEPM89M0024	Analog I/O option module (2 outputs, 4 inputs)
METSEPMRS4854W	4-wire RS-485 option module

Commercial reference	Description
METSEPMFIBER	Fiber Ethernet option module
METSEPM8000SK	Voltage and current sealing kit
METSEPMAK	Mounting adapter kit for remote display and DIN meter

Refer to your meter's catalog pages, available from www.se.com, for updated information on meter types and accessories.

Mounting adaptors

There are different mounting adaptor accessories that can help when installing your meter in existing panels and cutouts where the default mounting hardware is not appropriate.

Mounting adaptor kits are ordered separately from the meter.

Terminal covers

The voltage, current, and auxiliary power supply terminal covers help prevent tampering with the meter's measurement and auxiliary power supply inputs.

The terminal covers enclose the terminals, the conductor fixing screws and a length of the external conductors and their insulation. The terminal covers are secured by tamper-resistant meter seals.

These covers are included for meter models where sealable voltage, current, and auxiliary power supply terminal covers are required to comply with revenue or regulatory standards.

The meter terminal covers must be installed by a qualified installer.

Refer to your meter's installation guide or the instructions that came with your terminal covers for instructions on installing the terminal covers.

Cybersecurity

This chapter contains information about your product's cybersecurity. Network administrators, system integrators, and personnel that commission, operate, maintain, or decommission a device should review "Recommended actions" on page 23 to help secure your device in a protected environment.

Cybersecurity overview

Your device has security capabilities that:

- Allow it to be part of a NERC CIP compliant facility. For information on NERC Reliability Standards, go to the [North American Electric Reliability Corporation](#) website.
- Align with cybersecurity standards in the IEC 62443 international standard for business IT systems and Industrial Automation and Control Systems (IACS) products. For information about the IEC 62443 international standard, go to the [International Electrotechnical Commission](#) website.

WARNING

POTENTIAL COMPROMISE OF SYSTEM AVAILABILITY, INTEGRITY, AND CONFIDENTIALITY

- Change default passwords/passcodes to help prevent unauthorized access to device settings and information.
- Disable unused ports/services and default accounts, where possible, to minimize pathways for malicious attacks.
- Place networked devices behind multiple layers of cyber defenses (such as firewalls, network segmentation, and network intrusion detection and protection).
- Use cybersecurity best practices (for example: least privilege, separation of duties) to help prevent unauthorized exposure, loss, modification of data and logs, interruption of services, or unintended operation.

Failure to follow these instructions can result in death or serious injury or equipment damage.

Recommended actions

Your device is designed to be used in a protected environment that uses a defense in depth strategy, in compliance with IEC 62443, the global standard for industrial automation control system security.

To help secure your device, you must take specific actions at every stage of the project life-cycle.

NOTE: The list of recommended actions below is not a complete list of possible cybersecurity measures. It is meant to be a starting point to improve the security of your device in a protected environment. Consult with cybersecurity experts to plan, configure, operate, maintain, and decommission your device based on your needs.

The following table lists the actions we recommend you take to help secure your device in a protected environment, organized by life-cycle stage:

Recommended action	Defense-in-depth role
Plan	
Review cybersecurity awareness	Resources to increase your cybersecurity knowledge and awareness.
Review the system defense in depth assumptions	Understand the security measures expected to be provided by the external environment in which the device is to be used.
Review the device security capabilities	Understand how the device's security capabilities can be used in a protected environment.
Review the "Security risks and mitigation strategies" on page 31	Known security risks and the mitigation strategies to help minimize the risks.
Review the Security risks and mitigation strategies	Known security risks and the mitigation strategies to help minimize the risks.
Configure	
Change the default password *	Help reduce unauthorized access. Default account settings are often the source of unauthorized access by malicious users.
Disable meter configuration methods *	Limiting configuration options and providing read-only access reduces the attack surface of the meter.
Disable webpages and time sync sources *	Disable webpages to deny a web browser to access the meter data. If your meter can be accessed by a web browser outside your protected network, a malicious user could intercept communications. Disable the ability to modify the meter's time source to help protect against disguised communication from an unknown source as being trusted and possibly invalidating timestamps.
Define lockouts and timeouts *	Lock accounts after a predefined number of unsuccessful login attempts. Lockouts help reduce brute-force password attacks from succeeding. End a logged in session after a predefined period of inactivity. Session timeouts decrease the amount of the time an attacker has to hijack the valid session.

Recommended action	Defense-in-depth role
Limit user access *	<p>Limit user access to the minimum, least privilege level of access needed to perform their job functions.</p> <p>Revoke user privileges when no longer needed due to role change, transfer, or termination.</p>
Edit meter access event logging *	Edit the default meter access event priorities that are logged to the event log to meet your reporting requirements.
Create and change user passwords *	<p>Create strong passwords for each user that requires access to the meter. Default account settings and weak passwords are often the source of unauthorized access by malicious users.</p> <p>Follow user account management tasks as described by your organization or contact your network administrator. For example, maximum password age or history policies.</p>
Set up Advanced security *	Advanced security is the default meter security mode. If your meter uses standard security mode, we recommend you change it to advanced.
Disable unused protocols and change default port numbers	<p>Disable unnecessary and unused communication protocol ports, such as SFTP and network ports, to reduce the meter attack surface.</p> <p>Change port number default values to reduce the predictability of port use.</p> <p>See "Protocols, ports, and connections" on page 65.</p>
Revenue-lock the meter and use anti-tamper sealing points	Locks and anti-tampering help prevent unauthorized access to the meter, parameter values, and settings.
Validate security settings	Verify the meter security configuration.
Assign a dedicated reader for event log notifications	Assigning a dedicated reader can help prevent event log entries being overwritten before they are reviewed.
Configure syslog to store event logs	<p>A syslog server can receive logs from multiple devices and store the log information as needed. Syslog helps maintain meter log information for extended periods of time.</p> <p>See "Syslog" on page 212.</p>
Operate	
Monitor the event log	Monitor event logs for suspicious activity and to help identify the cause of cybersecurity breaches that could lead to a cybersecurity incident.
Report a cybersecurity incident or vulnerability	Report suspicious activity, a cybersecurity incident, or a vulnerability to Schneider Electric.
Maintain	

Recommended action	Defense-in-depth role
Apply firmware updates	Keeping your device firmware up to date helps protect you from security vulnerabilities.
Check the revenue lock and anti-tamper seals	Follow your company's policies and standards by periodically checking your device locks and seals to verify that the device has not been tampered with.
Review user accounts on a regular basis	Limit user access to the minimum, least privilege level of access needed to perform their job functions. Revoke user privileges when no longer needed due to role change, transfer, or termination. See "Limiting user access" on page 38 for details.
Keep your network security up to date.	Helps reduce your attack surface, decreasing the likelihood of a vulnerability.
Perform security audits	Help verify the security status of your system.
Decommission	
Record decommissioning activities	Document disposal actions according to your company's policies and standards to keep a record of activities.
Wipe the device	Help prevent the potential disclosure of data. Follow decommission and sanitization tasks as described by your organization or contact your network administrator.
Decommission-related rules and sanitize records	Decommission network and security rules. For example, a firewall rule that could be used to get past the firewall. Perform records tracking sanitization tasks to remove records in related systems. For example, monitoring SNMP servers.
Dispose, reuse, or recycle the device	Follow local disposal regulations.

* For detailed information on the default meter security settings, see "Default meter security settings" on page 46.

Plan

Before you install your device, use the following planning information to help you prepare for the installation and commissioning of your meter in your facility.

- "Cybersecurity awareness" on page 27
- "System defense-in-depth assumptions" on page 27
- "Device security capabilities" on page 28
- "Security risks and mitigation strategies" on page 31

Cybersecurity awareness

Knowledge is the first step to help prevent cyber intrusions. Review the following to increase your cybersecurity awareness:

- [Cybersecurity Best Practices guide](#)
- [EcoStruxure™ Power Guide for Designing and Implementing a Cyber Secure Digital Power System](#)

Subscribe to Schneider Electric security notifications

Register for Schneider Electric security notifications on the [Schneider Electric Cybersecurity Support Portal website](#).

System defense-in-depth assumptions

Defense-in-depth is an information security strategy integrating people, technology, and operations capabilities to establish variable barriers across multiple layers and dimensions in your information technology and control system.

Defense-in-depth helps minimize data protection gaps, reduces single-points-of-failure, and creates a strong cybersecurity posture. The more layers of security in your system, the harder it is to breach defenses, take digital assets or cause disruption.

Using a defense-in-depth strategy by securing the device in a protected environment will help reduce your attack surface, decreasing the likelihood of a vulnerability.

Before you install your device, review the following system defense-in-depth assumptions. If you have not already adopted these assumptions, we strongly recommend you add them to help improve your cybersecurity posture.

Site security assumptions

- **Perimeter security** – Installed devices, and devices that are not in service, are in an access-controlled or monitored location.
- **Emergency power** – The control system provides the capability to switch to and from an emergency power supply without affecting the existing security state or a documented degraded mode.

Network security assumptions

- **Controls against malware** – Detection, prevention, and recovery controls to help protect against malware are implemented and combined with appropriate user awareness.
- **Physical network segmentation** – The control system provides the capability to:
 - Physically segment control system networks from non-control system networks.
 - Physically segment critical control system networks from non-critical control system networks.

- **Logical isolation of critical networks** – The control system provides the capability to logically and physically isolate critical control system networks from non-critical control system networks. For example, using VLANs.
- **Independence from non-control system networks** – The control system provides network services to control system networks, critical or non-critical, without a connection to non-control system networks.
- **Zone boundary protection** – The control system provides the capability to:
 - Manage connections through managed interfaces consisting of appropriate boundary protection devices, such as proxies, gateways, routers, firewalls, and encrypted tunnels.
 - Use an effective architecture. For example, firewalls protecting application gateways residing in a DMZ.
 - Control system boundary protections at any designated alternate processing sites should provide the same levels of protection as that of the primary site. For example, data centers.
- **No public internet connectivity** – Access from the control system to the internet is not recommended. If a remote site connection is needed encrypt protocol transmissions.
- **Resource availability and redundancy** – Ability to break the connections between different network segments or use duplicate devices in response to an incident.
- **Manage communication loads** – The control system provides the capability to manage communication loads to mitigate the effects of information flooding types of DoS (Denial of Service) events.
- **Control system backup** – Available and up-to-date backups for recovery from a control system failure.
- **Encrypt protocol transmissions over all external connections** – Use an encrypted tunnel, TLS wrapper or a similar solution.

Administrative assumptions

- **Cybersecurity governance** – Available and up-to-date guidance on the secure use of information and technology assets in your company.
- **Firmware upgrades** – Meter upgrades are implemented consistently to the current version of firmware.

For detailed information on the device security capabilities, see "Device security capabilities" on page 28.

Device security capabilities

Your device includes security capabilities that, when combined with other defense-in-depth measures, can help reduce vulnerabilities.

Before you install your device, carefully review the following device security capabilities to understand how you can configure and use the device securely in a protected environment.

Security area	Device security capabilities	Role in defense-in-depth
Physical	<p>Revenue-lock switch</p> <p>Anti-tamper sealing points</p> <p>LED lock status indicator on the device</p> <p>Revenue lock icon on the display.</p>	<p>These capabilities help prevent unauthorized access to revenue-related parameters and settings or leave clear evidence that the device has been physically tampered with.</p>
Information confidentiality	<p>SSH, SFTP, and HTTPS support</p>	<p>These secure protocols employ cryptographic algorithms, key sizes, and mechanisms to help prevent unauthorized users from reading information in transit.</p>
Access	<p>User authentication identifies and authenticates software processes and devices managing accounts.</p> <p>Least privilege in multiple dimensions: read, peak demand reset, time sync, meter configuration, and security and communications configuration.</p> <p>User account lockout limits the number of unsuccessful login attempts.</p> <p>Use control restricts allowed actions to the authorized use of the control system.</p> <p>Supervisors can override user authorizations by deleting user accounts.</p> <p>Password strength feedback using ION Setup.</p>	<p>These capabilities help enforce authorizations assigned to users, segregation of duties, and least privilege.</p>

Security area	Device security capabilities	Role in defense-in-depth
Device configuration	<p>Internal time synchronization.</p> <p>Time source integrity protection and meter configuration event logging.</p> <p>Timestamps, including date and time, match the meter clock.</p> <p>The device embeds user information when a change is made.</p> <p>SSH server hosts an internal SFTP site and stores files in the meter's flash memory, such as webpages, COMTRADE records, and firmware files.</p> <p>Settings can be saved as a Security Configuration File (.scf) using ION Setup.</p> <p>Offload information to syslog or a protected storage or retention location.</p>	<p>These capabilities support the analysis of security and user account events and help protect the device from unauthorized alteration and record configuration changes.</p>
Device hardening	<p>Least functionality</p> <p>Default port numbers can be changed to lower the predictability of port use.</p> <p>Session lock requires sign in after a configurable time-period of inactivity for webpages and display (but not ION protocol.)</p> <p>End a session after a configurable time-period of inactivity</p> <p>Limit the number of concurrent user sessions</p>	<p>These capabilities help prohibit and restrict the use of unnecessary functions, ports, protocols, and services.</p>

Security area	Device security capabilities	Role in defense-in-depth
Operation	<p>Machine and human-readable reporting options for current device security settings.</p> <p>Audit event logs to identify:</p> <ul style="list-style-type: none"> • Meter configuration changes. • Energy management system events. <p>Audit record storage capacity communication to notify a user when the threshold is approaching.</p> <p>Audit storage capacity of 5,000 event logs by default and alternate methods for log management.</p> <p>Time source integrity protection and event logged when changed.</p>	<p>These capabilities help provide a method to generate security-related reports and manage event log storage.</p>
Maintenance: Upgrade and backup	<p>Digitally signed firmware is used to help protect the authenticity of the firmware running on the meter and only allows firmware generated and signed by the manufacturer.</p>	<p>This security capability helps protect the authenticity of the firmware running on the meter and facilitates protected file transfer.</p>
Decommissioning	<p>Purge shared memory resources through device wiping and other decommissioning tasks.</p> <p>Physical (recommended) or sustainable device disposal possibilities.</p>	<p>These capabilities help prevent the potential disclosure of data when the device is decommissioned.</p>

For detailed information on the system defense-in-depth assumptions, see "System defense-in-depth assumptions" on page 27.

For detailed information on how to help secure your device in a defense-in-depth protected environment, see "Recommended actions" on page 23.

Security risks and mitigation strategies

Review the following issues and security risks and the mitigation strategies to help minimize the risks:

Issue	Security risk	Mitigation strategies
User accounts Default account settings are often the source of unauthorized access by malicious users.	If you do not change the default password, unauthorized access can occur.	Change the default password of 0 (zero) to help reduce unauthorized access. See "Changing the default password" on page 33.
Secure protocols ION, Modbus, DNP, DLMS, IEC 61850 and some IT protocols are unsecure. The device does not have the capability to transmit data encrypted using these protocols.	If a malicious user gained access to your network, they could intercept communications.	For transmitting data over an internal network, physically or logically segment the network. For transmitting data over an external network, encrypt protocol transmissions over all external connections using an encrypted tunnel, TLS wrapper or a similar solution. See "System defense-in-depth assumptions" on page 27.

Configure

This section contains detailed information on the following tasks:

- "Meter security configuration" on page 32 in a protected environment
- "Disabling and enabling protocols and changing port numbers" on page 42
- "Verifying the meter security settings" on page 42
- "Applying security settings to multiple meters" on page 44

This section also includes the following reference information:

- "Default meter security settings" on page 46
- "Advanced security mode" on page 47

Meter security configuration

Meter security configuration using ION Setup consists of the following steps:

- Step 1: [Open a Security Configuration File](#)
- Step 2: [Configure the meter security settings](#)
- Step 3: [Push the updated security settings to the meter](#)
- Step 4: [Store the updated SCF file](#)

Opening a meter security configuration file

Meter security settings are stored in an encrypted Security Configuration File (SCF).

Use ION Setup to open a SCF file.

Prerequisites:

- Meter connection using ION Setup.
- Login credentials.
- Security configuration access privileges.

To open the meter security configuration file:

1. In ION Setup, select the meter, and then open **Setup Assistant**.
2. Click **Security > Security Mode > Edit**.
3. Enter the meter password, and then click **OK**.
4. Select the SCF file that you want to edit, and then click **Open**.

NOTE: We recommend that you use [Advanced security mode](#).

For more information on SCF files, see "Storing Security Configuration Files" on page 41.

The meter security configuration settings open in the ION Setup Security wizard.

Next, [configure the meter security settings](#).

Configuring the meter security settings

After you open a SCF file, ION Setup displays the security settings in a Security wizard.

Use the ION Setup Security wizard to complete the following security configuration tasks:

- "Changing the default password" on page 33
- "Disabling and enabling meter configuration options" on page 34
- "Disabling and enabling webpages and time sync sources" on page 35
- "Defining lockout and timeout" on page 35
- "Editing meter access event logging" on page 36
- "Limiting user access" on page 38
- "Creating and changing user passwords" on page 39

Changing the default password

Change the default password of 0 (zero) to help reduce unauthorized access. Default account settings are often the source of unauthorized access by malicious users.

Prerequisites:

- [Open a Security Configuration File](#) in the ION Setup Security wizard.

To change the default password:

1. In the ION Setup Security wizard, click **Next** to navigate to **Define individual users/passwords**.
2. Highlight **USER1**, and then click **Password**.
3. Enter and confirm the new password.

TIP: Use Password strength to increase the password complexity. A password can be any combination of letters and numbers, up to six characters.

4. Click **OK**.
5. Next, either:
 - Continue [configuring the meter security settings](#).
 - Click **Finish** to [push your security configuration changes to the meter](#).

Disabling and enabling meter configuration options

Limiting configuration options, such as Modbus, webpages, and the display, and providing read-only access reduces the attack surface of the meter.

Prerequisites:

- [Open a Security Configuration File](#) in the ION Setup Security wizard

To disable and enable meter configuration methods:

1. In the ION Setup Security wizard, click **Next** to navigate to **Security Options**.
2. In **Security Options**:

Select or clear **Enable Web** to enable or disable the ability to view meter settings online using webpages.

Select or clear **Allow setup by webpages** to enable or disable the ability to change meter settings using webpages.

Select or clear **Allow Front Panel programming** to enable or disable the ability to change meter settings using the display.

Select from the **Modbus Access** drop-down list:

- **None** – Disables built-in Modbus map access.
 - **Read/Write** – Enables configuration of basic metering parameters using only Modbus communications protocol.
 - **Read Only** – Enables ability to read metering parameters using only Modbus communications protocol. This option is enabled by default.
3. Next, either:
 - Continue [configuring the meter security settings](#).
 - Click **Finish** to [push your security configuration changes to the meter](#).

Disabling and enabling webpages and time sync sources

Disable webpages to deny a web browser to access the meter data. If your meter can be accessed by a web browser outside your protected network, a malicious user could intercept communications. See "Disabling and enabling protocols and changing port numbers" on page 42 for details on enabling HTTPS.

Disable the ability to modify the meter's time source to help protect against disguised communication from an unknown source as being trusted and possibly invalidating timestamps. See "[Configuring time information using ION Setup](#)" for detailed steps on setting up the time source.

Prerequisites:

- [Open a Security Configuration File](#) in the ION Setup Security wizard

To disable and enable webpages and time sync sources:

1. In the ION Setup Security wizard, click **Next** to navigate to **Security Options**.
2. In Security Options:
 - Select or clear **Enable Web** to enable or disable webpages for viewing meter data online using a web browser.
 - Select or clear **Allow Broadcasting Time Synchronization** to enable or disable the ability to modify the meter's time synchronization source.
3. Next, either:
 - Continue [configuring the meter security settings](#).
 - Click **Finish** to [push your security configuration changes to the meter](#).

Defining lockout and timeout

A lockout prevents anyone from logging into an account after a predefined number of unsuccessful login attempts. Lockouts help reduce brute-force password attacks from succeeding.

A session timeout ends a logged in session after a predefined period of inactivity. Session timeouts decrease the amount of the time an attacker has to hijack the valid session.

You can define the following account lockout and timeout options:

- Lockout after unsuccessful login attempts.
- Session timeout for ION protocol only.
- Lockout duration.

Prerequisites:

- [Open a Security Configuration File](#) in the ION Setup Security wizard

To define user lockouts and timeouts:

1. In the ION Setup Security wizard, click **Next** to navigate to **Select protocol lockout options**:

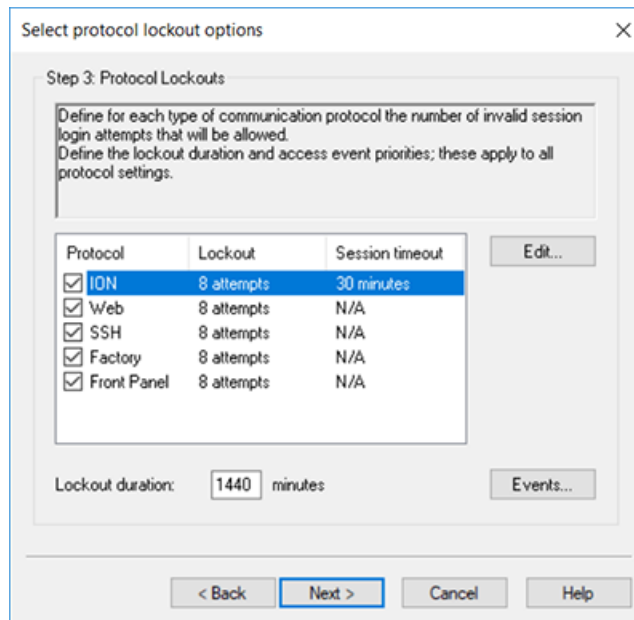

2. Select each protocol and click **Edit** to change lockout and session timeout values for:
 - Protocol lockout after unsuccessful login attempts.
 - Session timeout for ION protocol only. This is configurable because there is no login or logout action for ION protocol sessions.
3. Enter a value for the **Lockout duration** in minutes.
4. Next, either:
 - Continue [configuring the meter security settings](#).
 - Click **Finish** to [push your security configuration changes to the meter](#).

Editing meter access event logging

The event log monitors meter access events such as user logins and user account lockouts.

You can edit the default meter access event priorities that are logged to the event log to meet your reporting requirements.

To monitor meter access events, see "Monitoring the event log" on page 50.

Prerequisites:

- [Open a Security Configuration File](#) in the ION Setup Security wizard.

To configure meter access event logging:

1. In the ION Setup Security wizard, click **Next** to navigate to **Select protocol lockout options**:

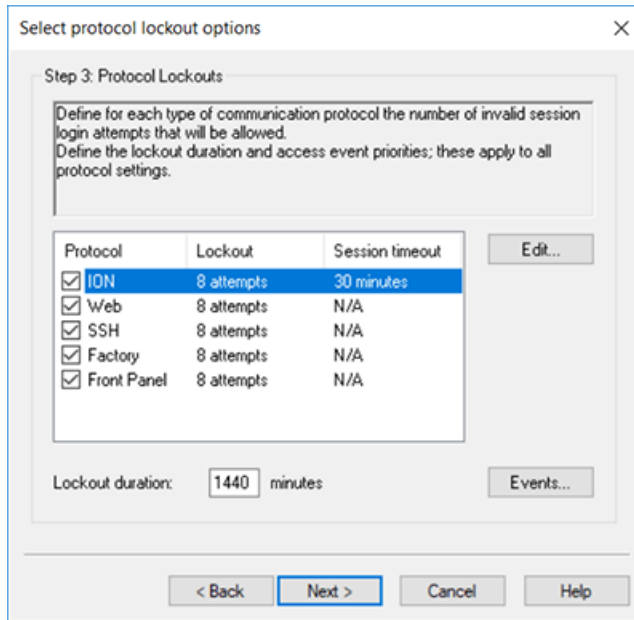

2. Click **Events**. The Event Priorities dialog box opens:

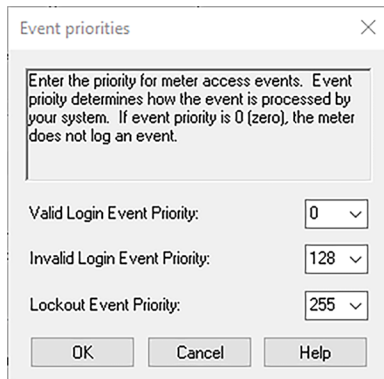

3. For each meter access event priority, set the value according to your reporting requirements. The following table describes the priority value ranges:

Priority	Description	Value range
None	Not recorded in the event log.	0
Info Only	The default event log cutoff value is 5. Event values equal to or less than the cutoff value are not recorded in the event log nor in syslog records.	1–5
	Recorded in the event log and in syslog records.	6–63
Low	Produces low alarm. Recorded in the event log and in syslog records.	64–127

Priority	Description	Value range
Medium	Produces medium alarm.	128–191
	Recorded in the event log and in syslog records.	
High	Produces high alarm.	192–255
	Recorded in the event log and in syslog records.	

4. Click **OK**.
5. Next, either:
 - Continue [configuring the meter security settings](#).
 - Click **Finish** to [push your security configuration changes to the meter](#).

You can also change event priorities for cybersecurity events using ION Setup Advanced Mode. See *ION Reference*, available from www.se.com, for information about working with modules.

Limiting user access

Limit user access to the minimum level of access needed to perform their job functions.

Revoke user privileges when no longer needed due to role change, transfer, or termination. User credentials do not expire.

NOTE: The maximum number of users is 50. Users can be added or removed at any time.

Prerequisites:

- [Open a Security Configuration File](#) in the ION Setup Security wizard

To define user access:

1. In the ION Setup Security wizard, click **Next** to navigate to **Define individual users/passwords**.

NOTICE

DATA LOSS

Record your device's user and password information in a secure location.

Failure to follow these instructions can result in loss of data.

- For each user, select the user, and then assign their permissions:

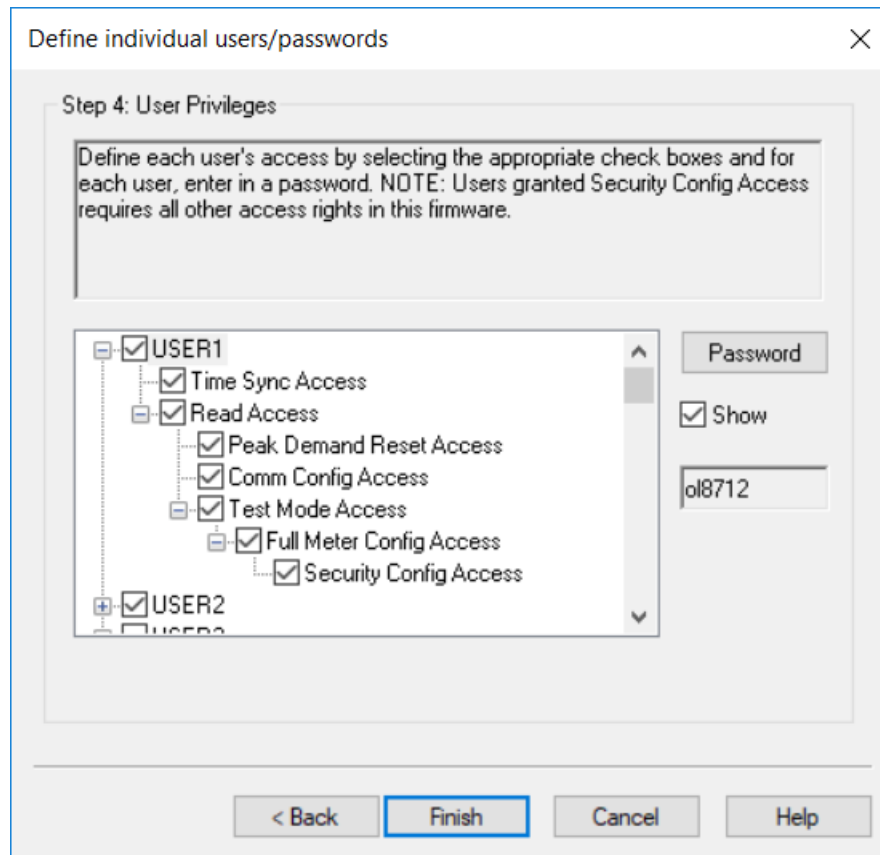

See for "Access " on page 29 information on the device access level permissions.

- Next, either:
 - Continue [configuring the meter security settings](#).
 - Click **Finish** to [push your security configuration changes to the meter](#).

Creating and changing user passwords

Create strong passwords for each user that requires access to the meter. Default account settings and weak passwords are often the source of unauthorized access by malicious users.

To optimize cybersecurity in a protected environment, follow user account management tasks as described by your organization or contact your network administrator, for example, maximum password age or history policies.

Prerequisites:

- [Open a Security Configuration File](#) in the ION Setup Security wizard.

To change a password:

- In the ION Setup Security wizard, click **Next** to navigate to **Define individual users/passwords**.

NOTICE

DATA LOSS

Record your device's user and password information in a secure location.

Failure to follow these instructions can result in loss of data.

2. For each user that you want to assign or change a password:
 - a. Highlight the USER, and then click **Password**.
 - b. Enter and confirm the password.

TIP: Use Password strength to increase the password complexity. A password can be any combination of letters and numbers, up to six characters.

- c. Click **OK**.
3. Next, either:
 - Continue [configuring the meter security settings](#).
 - Click **Finish** to [push your security configuration changes to the meter](#).

You can also change the password using ION Setup Diagnostics tool, Security Options Module using ION Setup Advanced Mode, and Power Monitoring Expert.

Setting up Advanced security

Meter security has strong user login, user access management, and password complexity.

NOTE: We recommend that you use Advanced security mode.

For detailed information on the Advanced security mode capabilities, see "Advanced security mode" on page 47.

Prerequisites:

- Meter connection using ION Setup.
- Login credentials.
- Security configuration access privileges.

To set up Advanced security:

1. Open ION Setup > select the meter > **Setup Assistant**.
2. **Security** > **Security Mode** > **Edit**. The Open Security Configuration file dialog box opens.
3. Select the **advanced.scf** security configuration file.
4. Click **Open**. If prompted, click **Yes** to use Advanced security.

5. Next, either:
 - Continue [configuring the meter security settings](#).
 - Click **Finish** to [push your security configuration changes to the meter](#).

Pushing updated security settings to the meter

After you have completed configuring the meter security settings, push the updated settings to the meter.

To push the updated security settings to the meter:

1. In the ION Setup Security wizard, click **Next** until you reach the Security wizard pane that has a **Finish** button.
2. Click **Finish**. A Confirmation message box opens.
3. Click **Yes** to confirm your changes.

ION Setup pushes your security configuration changes to the meter.

Next, [store the Security Configuration File](#).

Storing Security Configuration Files

After ION Setup pushes the security configuration updates to the meter, it prompts you to store the edited security settings to an encoded Security Configuration File (SCF).

We recommend that you store the SCF file using a new filename when you change the meter security settings. If you do not use a new SCF filename, your changes will overwrite the settings in the SCF file that you opened.

NOTE: If you don't store your security changes to a SCF file, your changes are stored on the meter only; no other record of your security configuration is kept.

ION Setup stores SCF files in the following folder: C:\ProgramData\Schneider Electric\ION Setup\Security

Store your meter's Security Configuration File (SCF) in a protected location.

WARNING

POTENTIAL COMPROMISE OF SYSTEM AVAILABILITY, INTEGRITY, AND CONFIDENTIALITY

Store Security Configuration Files (SCF) to a secure site.

Failure to follow these instructions can result in death, serious injury, equipment damage, or permanent loss of data.

Cybersecurity policies that govern how sensitive system files are securely stored vary from site to site. Work with the facility IT System Administrator to ensure that such files are properly secured.

Security log file

The first time you store a SCF file, ION Setup creates a security log file (`SECURITY.LOG`) in the `\Security` folder.

The security log file contains the history of security configuration files saved from ION Setup.

Use `SECURITY.LOG` to track meter security configuration changes and to select the correct SCF file for a meter whose security settings you want to edit or use in another meter.

NOTE: The security log file is stored as plain text.

Disabling and enabling protocols and changing port numbers

Disable unnecessary and unused communication protocol ports, such as SFTP, and network ports, to reduce the meter attack surface. Change port number default values to reduce the predictability of port use. See [“Protocols, ports and connections”](#) for port defaults.

Leave ION protocol enabled for configuration changes and upgrades. If ION protocol is disabled, use the display, Modbus programming, or webpages to access the meter.

Prerequisites:

- Meter connection using ION Setup.
- Login credentials.
- Security configuration access privileges.

NOTICE

LOSS OF ACCESS

Ensure you maintain sufficient access to communicate with and configure your device.

Failure to follow these instructions can result in loss of access to the device.

To disable and enable protocols and change port numbers:

1. In ION Setup, select the meter, and then open **Setup Assistant**.
2. Click **Communications > Advanced Ethernet > Protocols**.
3. Select the protocol, and then click **Edit**.
4. Change the default port number.
5. Enable or disable the protocol.
6. Click **OK**.
7. Click **Exit**.

Verifying the meter security settings

Generate a Meter Configuration Report to verify the meter security settings and user privileges.

Prerequisites:

- Meter connection using ION Setup.
- Login credentials.

To verify meter security settings:

1. In ION Setup, select the meter, and then open **Setup Assistant**.
2. Click **Reports > Meter Configuration > Display**. The Meter Configuration Report for your meter opens.
3. Scroll down to the Security section to validate the meter security settings. For example:

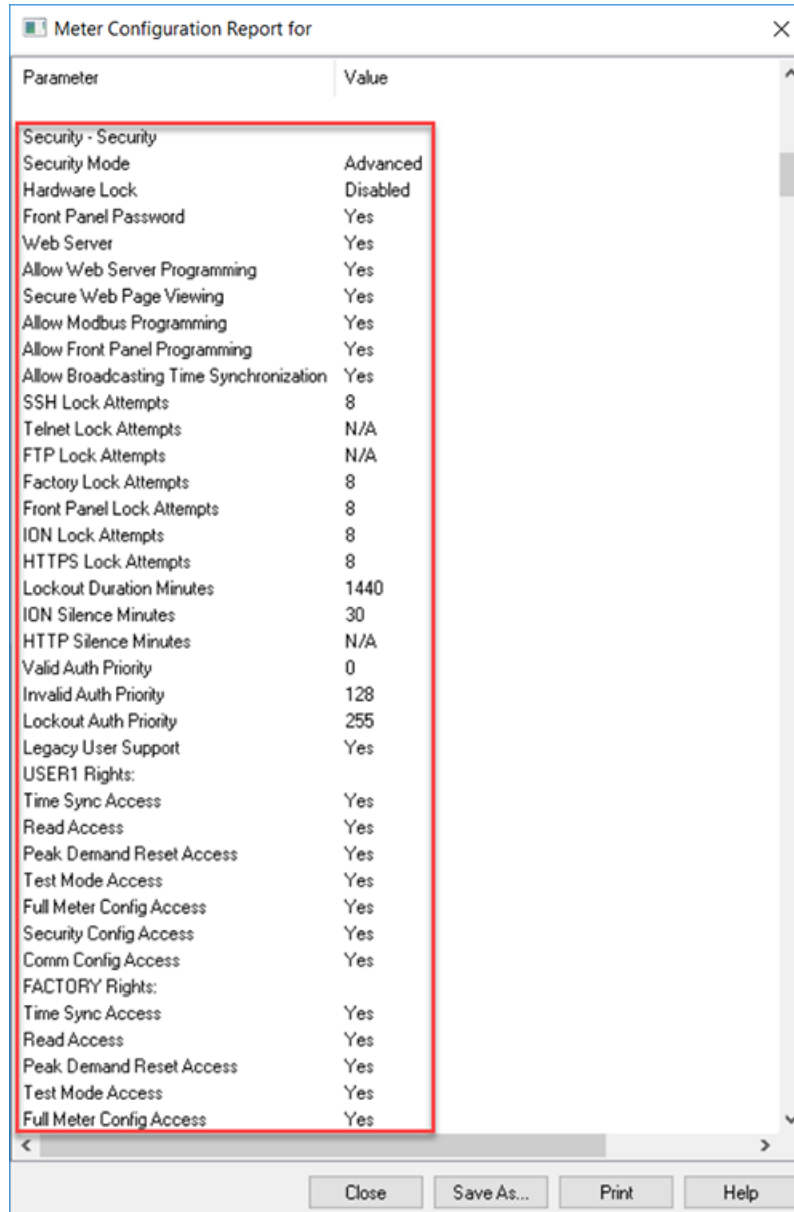

Parameter	Value
Security - Security	
Security Mode	Advanced
Hardware Lock	Disabled
Front Panel Password	Yes
Web Server	Yes
Allow Web Server Programming	Yes
Secure Web Page Viewing	Yes
Allow Modbus Programming	Yes
Allow Front Panel Programming	Yes
Allow Broadcasting Time Synchronization	Yes
SSH Lock Attempts	8
Telnet Lock Attempts	N/A
FTP Lock Attempts	N/A
Factory Lock Attempts	8
Front Panel Lock Attempts	8
ION Lock Attempts	8
HTTPS Lock Attempts	8
Lockout Duration Minutes	1440
ION Silence Minutes	30
HTTP Silence Minutes	N/A
Valid Auth Priority	0
Invalid Auth Priority	128
Lockout Auth Priority	255
Legacy User Support	Yes
USER1 Rights:	
Time Sync Access	Yes
Read Access	Yes
Peak Demand Reset Access	Yes
Test Mode Access	Yes
Full Meter Config Access	Yes
Security Config Access	Yes
Comm Config Access	Yes
FACTORY Rights:	
Time Sync Access	Yes
Read Access	Yes
Peak Demand Reset Access	Yes
Test Mode Access	Yes
Full Meter Config Access	Yes

4. Click **Close** or **Save As** to save the report as a .txt file.
5. (Optional) Edit the meter security settings.

Viewing the Device Configuration Checklist

View the Device Configuration Checklist to verify that the default password is not being used.

To view the checklist:

1. Click **Tools > Options**.
2. Click the Assistant tab and select the **Configuration Checklist** check box.

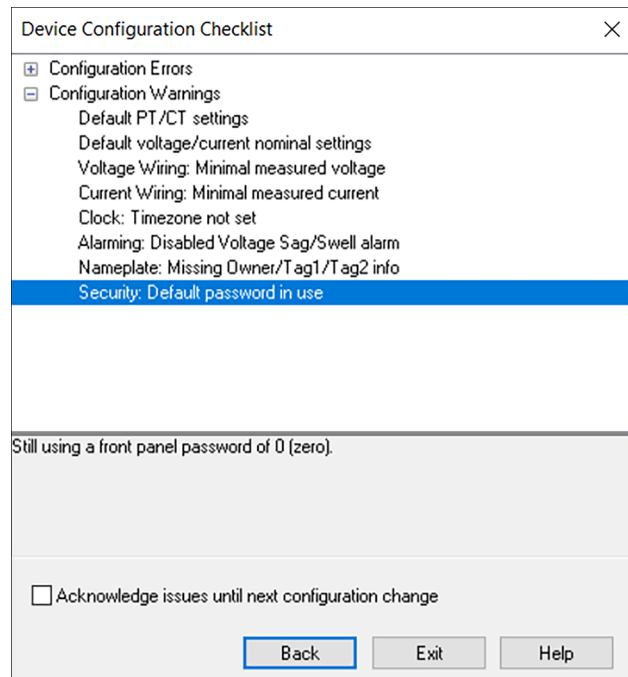

Applying security settings to multiple meters

A Security Configuration File (SCF) can be applied to other meters. If differences in capabilities between meters exist, ION Setup will indicate a capability is not available.

Prerequisites:

- Meter connection using ION Setup.
- Login credentials.
- Saved Security Configuration File (.scf).

NOTICE

DATA LOSS

Record your device's user and password information in a secure location.

Failure to follow these instructions can result in loss of data.

To apply security settings to multiple meters:

1. Open ION Setup > select the meter > **Setup Assistant**.
2. **Security > Security Mode > Send**. The Open Security Configuration file dialog box opens.
3. Open the meter security configuration file.

TIP: Open the security log file to determine the SCF file you want. See "Opening a meter security configuration file" on page 33 for more information.

4. Click **Yes** to confirm the security update.
The security settings in the SCF file are sent to the meter.
5. Click **Exit**.

Updating passwords on multiple meters

Use the ION Setup Diagnostics tool to update passwords on multiple meters at the same time.

Prerequisites:

- Meter connection using ION Setup.
- Login credentials.
- Security configuration access privileges.

NOTICE

DATA LOSS

Record your device's user and password information in a secure location.

Failure to follow these instructions can result in loss of data.

To update passwords on multiple meters:

1. Open ION Setup > select the System.
2. **Tools > Diagnostics**. The Systems diagnostics: System dialog box opens.
3. Select the **Tools** tab > **Advanced Security Password Updater**.
4. Click **Open**.
5. Select the meters that need a password update.
6. Click **Set Info**.
7. Click **Start**.
8. Click **Allow passwords to be visible**.
9. Select each user, click **Password**, and then enter a new password.
If the meter is connected to a display, update the password for the Front Panel.
10. Click **Start**. A Notice message box opens.

11. Click **Proceed**. A result is displayed for each device.
12. Click **Save As** to save a copy of updated meter passwords in a .txt file. The Save As dialog box opens.
13. Save the file with a unique file name to a protected location. An ION Setup message box opens.
14. Click **OK**.
15. Click **Exit**.
16. Click **Close**.

Default meter security settings

Review the following default meter security settings to understand how you can securely commission your meter:

Area	Setting	Default
Communications protocols	HTTPS with HTTP redirect	Enabled
	SSH Terminal	Disabled
	SFTP	Enabled
	Modbus TCP	Enabled
Time and time keeping	Broadcast time synchronization	Enabled
Webpages	Webpages	Enabled
Configuration	Configuration using the display	Enabled
	Configuration using webpages	Disabled
	Configuration using Modbus programming	Disabled
Meter access event logging	Valid login event priority	0 (No priority)
See "Editing meter access event logging" on page 36 for details.	Invalid login event priority	128 (Medium priority)
	Lockout event priority	255 (High priority)

Area	Setting	Default
Security mode	Advanced security mode (advanced.scf)	Enabled if Advanced security was used before upgrading meter firmware to v3.0.0. See "Advanced security mode" on page 47 for details.
	Legacy security support (standard.scf)	Enabled if Standard security was used before upgrading meter firmware to v3.0.0. We recommend that you use Advanced security mode. See: <ul style="list-style-type: none"> • "Legacy security support" for details on Legacy security support. • "Setting up Advanced security" on page 40 for information on switching to Advanced security mode.

See "Recommended actions" on page 23 for guidance on how to configure and use your meter in a protected environment.

Advanced security mode

Advanced security mode lets you add up to 50 users, has strong user login, and privilege management.

NOTE: We recommend that you use Advanced security mode.

This topic lists the advanced mode security capabilities, as well as detailed information on user access permissions, and the default username and password.

Advanced security mode capabilities

The following table lists the security capabilities of advanced security mode:

Security capability	Description
User credentials and password robustness	Use a single account to access the meter with a numeric password for login.
	Use multiple user accounts with alphanumeric passwords for login and configuration changes.
	Password range and limit: Any combination of letters and numbers, up to 6 characters.
	Password strength feedback using ION Setup.
User account lockouts and timeouts	Define user account lockout criteria after unsuccessful login attempts and define session timeout length.
User privileges	User accounts with variable permissions to read access or configuration privileges.
Webpages	Disable or enable webpages for viewing meter data online using a web browser (Web Server).

Security capability	Description
Configuration	Disable or enable ability to configure the meter using: <ul style="list-style-type: none"> • Modbus communications programming or allow read-only viewing. • The display • Meter webpages (Web Server programming).
	Disable and enable time synchronization.
	Password required for broadcast time synchronization configuration changes using the display or communication protocols.
Cybersecurity event logs and reports	Set up cybersecurity event logs and alarms using event priorities.

User access (Advanced security mode only)

The following table lists the Advanced security mode user access details:

Access type	Permission
Time Sync Access	Set the meter's time and time synchronization parameters.
Read Access	View parameters, except security configuration.
Peak Demand Reset Access	Reset peak demand values.
Comm Config Access	Configure communication settings.
Test Mode Access	Switch the meter to test mode, if available with your meter type.
Full Meter Config Access	Configure meter settings.
Security Config Access	Configure security settings.

User accounts (Advanced security mode only)

The following table lists the Advanced security mode user account details:

Username	Default password	Account description
User1	0 (zero)	Default administrator. This account has full meter access, including configuration.
User2	0 (zero)	Default viewer. This account has view only access.
User3, User4, ... User50	-	These user accounts are not activated; they do not have default passwords.

See "Changing the default password" on page 33.

See "[Legacy security support](#)" for information on Legacy security support default passwords and usernames.

See "Setting up Advanced security troubleshooting" on page 266 for troubleshooting information.

Operate

Review the following recommended actions to operate your device in a protected environment:

- "Monitoring the event log" on page 50
- "Revenue lock LED behavior" on page 257
- "Reporting a security incident or vulnerability " on page 50

Monitoring the event log

Monitor event logs for suspicious activity and to help identify the cause of cybersecurity breaches that could lead to a cybersecurity incident.

NOTE: The default event log limit is 5,000 records. When the limit is reached, new log entries overwrite older ones. To be notified when the Event Log record limit is approaching, see [Assigning a designated reader for event log notification](#). To extend log record retention, offload information to syslog or a protected storage or retention location, see [Configuring Syslog network settings using ION Setup](#).

For more information on meter access logging events, see "Editing meter access event logging" on page 36.

Prerequisites:

- Meter connection using ION Setup.
- Login credentials.

To monitor the event log:

1. In ION Setup, select the meter, and then open **Setup Assistant**.
2. Click **Reports > Event Log > Display**.
3. Select the range of records you want to view, the type, and then click **OK**.
4. Click **Save As** to save the log to your local machine or print the event log.
5. Click **Close**.

Reporting a security incident or vulnerability

To report suspicious activity or a cybersecurity incident, go to the [Schneider Electric Report an Incident website](#).

To report a security vulnerability affecting your product or solution, go to the [Schneider Electric Report a Vulnerability website](#).

Maintain

This section contains information on the tasks you should perform periodically to help maintain the security of your meter in a protected environment.

Viewing and downloading an event log

Generate an event log report to assist with cybersecurity incident investigations.

Event logs contain meter configuration changes and energy management system events.

Prerequisites:

- Meter connection using ION Setup.
- Login credentials.
- Configured event logs and alarms.

To view and download an event log:

1. Open > select the meter > **Setup Assistant**.
2. Click **Reports > Event Log > Display**. The Log reports dialog box opens.
3. Select a record range for the report and click **OK**:

The Event Log for your meter opens.

NOTE: Only All available records and Last options are available for Event Logs.

4. Click **Save As**.
5. Select **CSV** or **TXT** > **Save**.
6. Click **Close**.

Upgrades and security configuration

When meter firmware or ION Setup software is upgraded – security configuration remains the same until changed, including usernames and passwords. It is recommended security configuration is reviewed after an upgrade to analyze privileges for new or changed device features and revoke or apply them according to your company's policies and standards.

For detailed information on upgrading firmware, see "Firmware upgrades" on page 246.

Decommission

Review the following recommended actions to decommission your device in a protected environment:

- Record activities – Document disposal actions according to your company's policies and standards to keep a record of activities.

- "Wiping the device" on page 52
- Decommission-related rules and sanitize records:
 - Follow decommission and sanitization tasks as described by your organization or contact your network administrator.
 - Decommission network and security rules. For example, a firewall rule that could be used to get past the firewall.
 - Perform records tracking sanitization tasks to remove records in related systems. For example, monitoring SNMP servers.
- "Disposal, reuse, recycling" on page 55

Wiping the device

Wipe the device before decommissioning it to help prevent potential disclosure of data.

Prerequisites:

- Meter connection using ION Setup.
- Login credentials.
- Security configuration access privileges.

NOTICE

DATA LOSS

Ensure all important data from the device is saved before performing a reset.

Failure to follow these instructions can result in data loss.

NOTICE

LOSS OF ACCESS

Ensure you maintain sufficient access to communicate with your device.

Failure to follow these instructions can result in loss of access to the device.

NOTE: Complete the following tasks in the order listed; overwrite the communications module registers last to maintain meter connectivity.

To wipe the device:

1. Overwrite the meter template file. This overwrites the meter template with the default factory template. See ["Overwriting the Meter template file"](#) for detailed steps.
2. Delete files in the **documents** folder in SFTP file directory using SFTP client software. See ["SFTP"](#) for more information.

3. Delete the custom SSL certificate. See [“Deleting a custom SSL certificate”](#) for more information.
4. Delete webpages. See [“Deleting custom webpages”](#) for more information.
5. Delete the IEC 61850 configuration file. This deactivates functions related to the IEC 61850 protocol. See [“Deleting an IEC 61850 configuration file”](#) for more information.
6. Restore default security configuration. See [“Restoring default security configuration”](#) for more information.
7. Overwrite factory module registers. This deletes values for:
 - Device owner.
 - Device tag.
 - Device location.
 - Device name.See [“Overwriting factory module registers”](#) for more information.
8. Perform a master reset. This deletes values for:
 - Event log, data, and waveform records.
 - Power quality event (COMTRADE) files.
 - Energy, metering, min./max., revenue and test mode, and peak demand values.
 - Disturbance (sag/swell event) counter, EN 50160 parameters and statistics.
9. Overwrite communications module registers. This deletes values for network infrastructure details. See [“Overwriting communications module registers”](#) for more information.

Overwriting the meter template file

1. Go to www.se.com and search for the meter template for your device.
2. Download the ZIP file and extract files.
3. Open ION Setup.
4. Click the meter to select it > **Setup Assistant**.
5. Click **Template** > **Send to Meter** tab.
6. Click **Send**.
7. Navigate to the extracted files and select the DCF file.

NOTE: FWN file type is also an option.

8. Click **Open**.
9. Click **Proceed**. The Template Paste Options dialog box opens.
10. Clear all check boxes and click **OK**.
11. Click **Yes**. The overwriting process could take a few minutes.

12. Click **OK**.
13. Click **Exit** and then **OK**.

Restoring default security configuration

NOTICE

DATA LOSS

Record your device's user and password information in a secure location.

Failure to follow these instructions can result in loss of data.

1. Open ION Setup > select the meter > **Setup Assistant**.
2. Click **Security** > **Security Mode** > **Edit**. The Open Security Configuration file dialog box opens.
3. Select the **standard.scf** and click **Open**. If prompted, click No to use Legacy security support.
4. Click **Next** to navigate to the Define individual users/passwords screen.
5. Click **Finish**. The Confirmation message box opens.

Overwriting factory module registers

1. Open ION Setup.
2. Ctrl + click on the meter to select it. This switches ION Setup to Advanced mode.
3. Double-click **Factory Modules** folder > select meter type.
4. Select the **Setup Registers** tab.
5. Type text or characters to replace values for these setup registers by selecting them and click **Edit**:
 - FAC1 Device Namespace.
 - FAC1 Device Name.
 - FAC1 Owner.
 - FAC1 Tag1.
 - FAC1 Tag2.
6. Click **Send**.

Overwriting communication module registers

1. Open ION Setup.
2. Ctrl + click on the meter to select it. This switches ION Setup to Advanced.
3. Double-click **Comm Modules** folder > **Ethernet** > **Setup Registers**.

4. Type text or characters to replace values for network infrastructure setup registers by selecting them and clicking **Edit**. Some registers include:
 - Stored IPv4 Address.
 - Stored IPv4 Subnet Mask.
 - Stored IPv4 Gateway.

NOTE: IP values can be replaced with text.

 - Primary DNS.
 - Secondary DNS.
 - All servers.
 - All port numbers.
 - Ethernet Device Name.
 - Stored IPv6 Global Gateway.
 - Domain Name.
5. Click **Send**.

Disposal, reuse, recycling

Before removing the device from its intended environment, follow the recommended actions in "Decommission" on page 51.

Follow device removal tasks described by your organization or contact your network administrator to determine a responsible method of disposal.

Dispose the device according to the legislation of the country. Some regulatory organizations include:

- The United States [Environmental Protection Agency \(EPA\)](#) for guidance on the sustainable management of electronics.
 - The EPA provides an [Electronic Product Environmental Assessment Tool \(EPEAT\)](#) that helps assess the environmental attributes of electronics.
- The European [Waste Electrical & Electronic Equipment Directive \(WEEE Directive\)](#) is the [community](#) directive on [waste electrical and electronic equipment](#).
- The European [Restriction of Hazardous Substances Directive \(RoHS\)](#) directive on the restriction of the use of certain hazardous substances in electrical and electronic equipment.

NOTICE

UNAUTHORIZED OR UNINTENDED ACCESS TO CONFIDENTIAL DATA

Store devices that are not in service in an access-controlled or monitored location.

Failure to follow these instructions can result in unauthorized or unintended access to sensitive or secure customer data.

Device disposal

It is recommended that the entire device is physically destroyed. Destroying the device helps prevent potential disclosure of data contained in the device that was not removed.

 WARNING**HAZARD OF PHYSICAL INJURY**

- Do not destroy devices without the proper safety training.
- Never burn a device, put a device in a microwave, or pour acid on a device.

Failure to follow these instructions can result in death or serious injury.

Device reuse

Store the device in a location that is access controlled or monitored if there is potential for reuse.

Device recycling

Go to www.se.com and search for the Product Environmental Profile for your meter type to get instructions on managing e-waste.

Installation and commissioning

This chapter supplements the meter installation guide and provides guidance on commissioning your meter.

- See your device installation guide for information related to installation.
- See your product catalog pages at Schneider Electric for information about your device, its options, and accessories.
- Download updated documentation from www.se.com.

For the latest information about your product, or for assistance in advanced features and custom functionality, contact your local Schneider Electric representative.

Installation

Installation, wiring, testing and service must be performed in accordance with all local and national electrical codes.

DANGER

HAZARD OF ELECTRIC SHOCK, EXPLOSION OR ARC FLASH

- Apply appropriate Personal Protective Equipment (PPE) and follow safe electrical work practices. See NFPA 70E, CSA Z462 or other local standards.
- Turn off all power supplying this device and the equipment in which it is installed before working on or in the equipment.
- Always use a properly rated voltage sensing device to confirm that all power is off.
- Do not use the data from the meter to confirm power is off.
- Do not exceed the maximum ratings of this device.
- Do not short secondary terminals of Voltage Transformer (VT).
- Do not open secondary terminals of Current Transformer (CT).
- Ground secondary circuit of CTs.
- Do not install CTs in equipment where they exceed 75% of the wiring space of any cross-sectional area in the equipment.
- Do not install CTs in areas where ventilation openings may be blocked or in areas of breaker arc venting.
- Do not install CTs using Class 2 wiring methods or connect to Class 2 equipment. See NFPA 70.
- Secure CT secondary conductors to ensure they do not contact live circuits.
- Assume communications and I/O wiring are hazardous live until determined otherwise.
- Replace all devices, doors and covers before turning on power to this equipment.

Failure to follow these instructions will result in death or serious injury.

Power system wiring

You can connect the meter's voltage inputs directly to the phase voltage lines of the power system if the power system's line-to-line or line-to-neutral voltages do not exceed the meter's direct connect maximum voltage limits.

The maximum voltage allowed for direct connection may be lower than the manufacturer-specified limits, depending on the local electrical codes and regulations.

If your system voltage is greater than the specified direct connect maximum voltage, you must use voltage (potential) transformers (VTs/PTs) to step down the voltages.

Residual current measurement

The meter can calculate or measure the residual current, depending on how the inputs are wired.

3 CT wiring

For a 3-phase 3-wire system, the meter calculates residual current for Ground.

For a 3-phase 4-wire system, the meter calculates residual current for Neutral.

For a 3-phase 3-wire system, the meter measures the residual current for Ground at I4.

For a 3-phase 4-wire system, the meter measures the residual current for Neutral at I4.

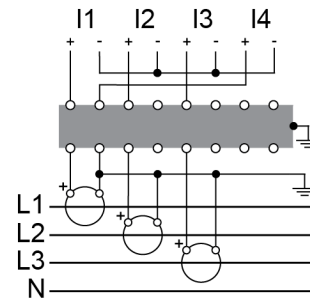
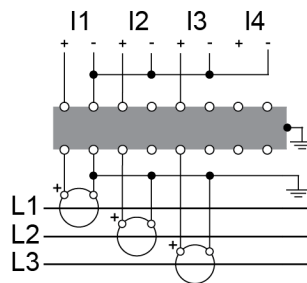

Option modules

Option modules are ordered separately from your meter and can be connected to your meter without specialized equipment.

Option modules are identified based on how they are physically connected to the meter's external I/O bus.

The first connected module, attached directly to the meter, is Module A. The second module, attached to Module A, is Module B. The meter supports up to four external modules:

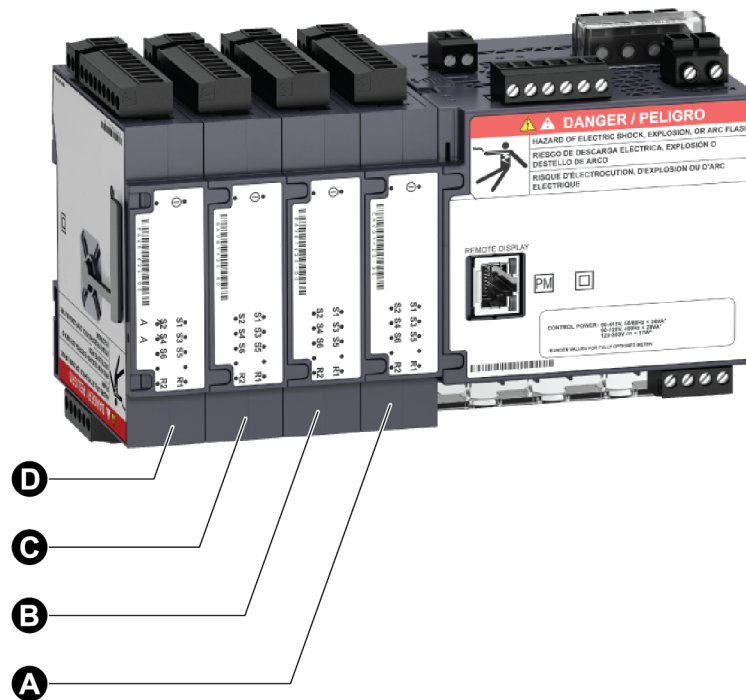

Option modules are monitored and controlled by the meter's ION modules. External I/O modules are mapped to the corresponding ION modules:

Option module physical position	ION module mapping
Module A to Module D	Port A to Port D

Option module terminal connector label	ION module mapping
Analog inputs A1 to A(n)	Analog Input module A1 to A(n)
Analog outputs Q1 to Q(n)	Analog Output module Q1 to Q(n)
Digital inputs S1 to S(n)	Digital Input module S1 to S(n)
Digital/relay outputs R1 to R(n)	Digital Output module R1 to R(n)

Maximum number of option modules

Up to four option modules are supported per device.

Limitations:

- Only one 4-wire RS-485 module and one Fiber Ethernet module may be installed.
- Depending on the type and quantity of option modules attached to your meter, you may need to reduce your meter's maximum operating temperature or limit the number of option modules. See "Maximum operating temperature with option modules" on page 272 for more information.
- For a panel mount meter, one limitation on the number of modules that can be attached is the physical strength of the meter mounting hardware. If your meter is mounted in an area subject

to vibration or other physical stresses, your meter's ability to physically support multiple option modules and maintain a seal against the mounting surface may be affected. See "Mechanical characteristics" on page 269 for more information.

NOTICE

EQUIPMENT DAMAGE

Do not exceed the maximum number of option modules.

Failure to follow these instructions can result in equipment damage.

Panel-mount meter and remote display mounting and wiring recommendations

There are supplemental mounting and wiring recommendations that apply to panel-mount meters and remote displays.

- The meter is intended to be mounted inside a ¼-DIN panel cutout.
- Inspect the gasket (installed around the perimeter of the display) and make sure it is secured properly and not damaged.
- The meter retainer clips, located on either side of the meter base and used to secure the meter in the panel, do not usually require any tools to install. If necessary, for panels with limited space, you can use a long-handled slot screwdriver to help install the meter retainer clips.
- The remote display can only be used with the DIN meter; it cannot be used by meters with an integrated display.
- The remote display's power and communications is provided through a single, direct, point-to-point connection from the remote display to the DIN meter.

Commissioning

Factory default settings

Use these default values the first time you connect to your meter.

Parameter	Default value
Password to log onto meter webpages or access display	0
Username to log onto meter webpages	USER1
IP address ¹	169.254.0.10
Subnet mask	255.255.0.0
Gateway	0.0.0.0

¹The IPv6 link local address can also be used. See [Self-discovery over Ethernet](#) for details.

Parameter	Default value
RS-485	COM1 Unit ID: 100
Language	English

Commissioning using ION Setup

Use ION Setup to commission the meter for integration into your energy management system.

Connect to your meter using ION Setup then use the Setup Assistant to configure the meter. Setup parameters are arranged in logical groupings and category folders.

Before exiting the Setup Assistant, ION Setup performs a meter configuration test and displays the results. You can review the results and make changes as needed.

To turn off the meter configuration test:

1. Click **Tools > Options**.
2. Click the Assistant tab and clear the **Configuration Checklist** check box.

NOTE: ION Setup also performs a configuration test and displays results when configuring certain features such as the Sag/Swell Logging wizard in the Power Quality Setup Assistant.

Configuring metering parameters

Use ION Setup to configure the meter's metering functionality.

1. Start ION Setup and open the Setup Assistant for your meter.
2. Configure the parameters in **Metering Setup > Basic**.

Basic tab

Parameter	Values	Description
Volts Mode	4W-WYE, DELTA, 3W-WYE, SINGLE, DEMO ¹	Power system type
PT Prim	1–999,999	Potential transformer's primary winding voltage rating
PT Sec	1–999,999	Potential transformer's secondary winding voltage rating
CT Primary	1–999,999	Current transformer's primary winding current rating
CT Secondary	1–999,999	Current transformer's secondary winding current rating

¹Demo mode is for demonstration only, and does not use the meter input terminals to display values.

Parameter	Values	Description
Nominal Voltage	1–999,999	Nominal voltage (V) used for metering functions such as harmonic calculations and sag/swell detection
Nominal Current	1–999,999	Nominal current (A) used for metering functions such as harmonic calculations and sag/swell detection
Nominal Frequency	50, 60	Nominal frequency (Hz) used for metering functions such as alarms

- Configure the parameters in **Metering Setup > Advanced**, if appropriate.

Advanced tab

Parameter	Values	Description
PhaseOrder	ABC, ACB	Power system's rotation order of voltage phases
I4 Prim	1–999,999	I4 current transformer's primary winding current rating
I4 Sec	1–999,999	I4 current transformer's secondary winding current rating
Scale Rev Param	ON, OFF	Specifies whether revenue readings are presented as primary or secondary side values (ON = primary side, OFF = secondary side)

Using the Phasor Viewer

Phasor diagrams can help verify or troubleshoot issues with voltage and current input wiring.

Use ION Setup's Phasor Viewer to display a real-time phasor diagram of the voltage and current input signals.

To use the Phasor Viewer:

- Start ION Setup and open the **Setup Assistant** for your meter.
- Click **Metering Setup > Phasor**.
- Select **Phasor Viewer** and click **Show**.
- To change the polarity of the voltage or current inputs, click **Show Setup** to display the Polarity Settings.

Select the box beside the input you want to invert polarity, then click **Apply to Meter**.

Basic setup using the webpages or display

You can use the meter webpages or display to configure basic metering parameters.

- Using the webpages: Navigate to **Setup > Metering**.
- Using the display: Navigate to **Setup Menu > Meter Setup**.

Communications

Communications overview

Communications is the transfer of data to and from the meter and is controlled by a combination of hardware and software components in the meter.

For each connected communications port, the meter uses the applicable communications protocol to establish communications with other devices or software. The protocol manages the communications session and defines the set of rules, commands, and packet structure of the transmitted data. You can also control which protocols are enabled or disabled on the meter.

NOTE: To maximize the performance of your power management system, it is recommended that devices be connected directly to an Ethernet network.

Other means of controlling communications, such as who can access certain types of meter data, are discussed in the security topics for the meter.

Your meter's default protocol settings meet the needs of most systems with only basic configuration. You can customize these settings to meet your specific needs. These are advanced procedures that require an understanding of your meter's architecture, supported protocols, and the communications network and power system that your meter is connected to.

Ethernet communications

Your Ethernet connection source should be installed in a location that helps minimize the overall Ethernet cable routing length and complexity of your network.

The meter supports a single IP address for both physical Ethernet connections.

Your device's second Ethernet port acts as an Ethernet switch to help simplify network connections and reduce installation time and costs, by having shorter Ethernet cable runs between devices without needing additional Ethernet routers or repeaters. You cannot connect your meter to two different Ethernet networks. The two Ethernet ports do not split the signal, so connecting both ports should not impact your communications speed.

The meter uses dual-stack IPv4/IPv6 routing technology to manage network communications and allow network hosts to communicate with the meter using either IPv4 or IPv6.

Ethernet communications connections

Your meter's dual port Ethernet connections enable you to use straight-line or network loop (ring) topology.

If local network loop Ethernet topology is required, you must enable RSTP for your meter's Ethernet communications to function.

Use CAT5 (or higher) Ethernet cables with unshielded RJ45 modular connectors to wire your meter's Ethernet communications.

Ethernet loop topology

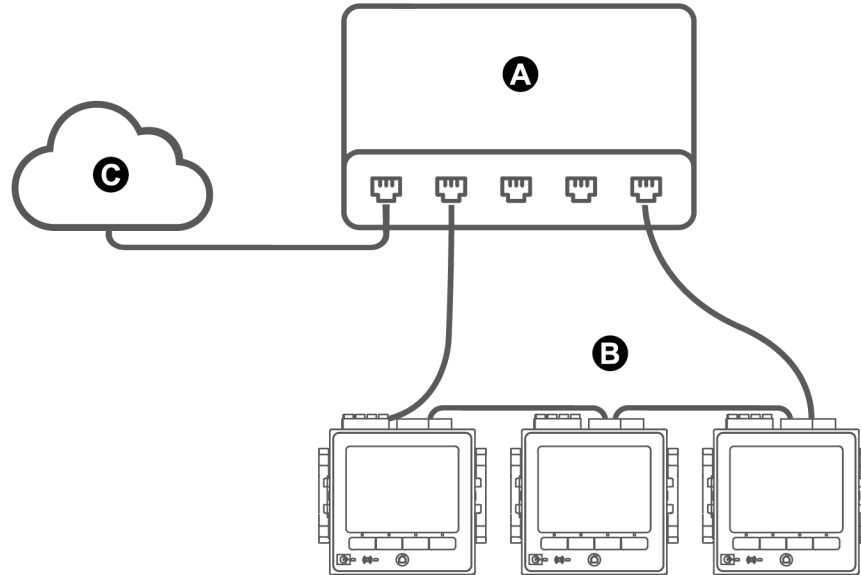

A	Ethernet switch or hub
B	Ethernet connected meters
C	LAN / WAN

Protocols, ports, and connections

The Ethernet protocols supported by your device allow simultaneous connections through the IP service ports.

NOTE: Some protocol port numbers are read-only and not configurable.

Protocol, ports, and connections

Protocol	Port (default)	Number of connections
ION	7700	8
Modbus TCP ¹	502	8 ²
Modbus RTU over Ethernet ³	7701	8 ⁴
DNP	20000	8 ⁵

¹These protocols must be enabled for Modbus gateway functionality.

²DNP. You can have a maximum of three DNP connections.

³These protocols must be enabled for Modbus gateway functionality.

⁴These eight simultaneous connections are shared by ION, Modbus TCP, Modbus RTU over Ethernet and DNP. You can have a maximum of three DNP connections.

⁵These eight simultaneous connections are shared by ION, Modbus TCP, Modbus RTU over Ethernet and DNP. You can have a maximum of three DNP connections.

Protocol	Port (default)	Number of connections
Modbus TCP (dedicated) ¹	502	32
EtherGate (Com1)	7801	1
DHCP	67 (68)	1
SFTP	22	2
Webserver (HTTPS) ²	443	10
SNMP	161	N/A
SMTP server (email) outgoing only	25	1
NTP	123	1
IEC 61850	102	4

By enabling or disabling TCP/IP protocols, you can control whether your meter accepts new socket connection requests. Changing settings for one port does not impact the other existing connections. Depending on the protocol, you can also change the port number.

Self-discovery over Ethernet

Your meter supports DPWS (devices profile for web services) which allows for self-discovery of the meter when it is connected to your local area network.

When you connect your meter to your network, your meter automatically appears in your network in Windows Explorer under Other Devices. By default, the meter is named <meter type>-<last six digits of MAC address>. For example, a meter with a MAC address of 006078173393 appears on the network as <meter type>-173393.

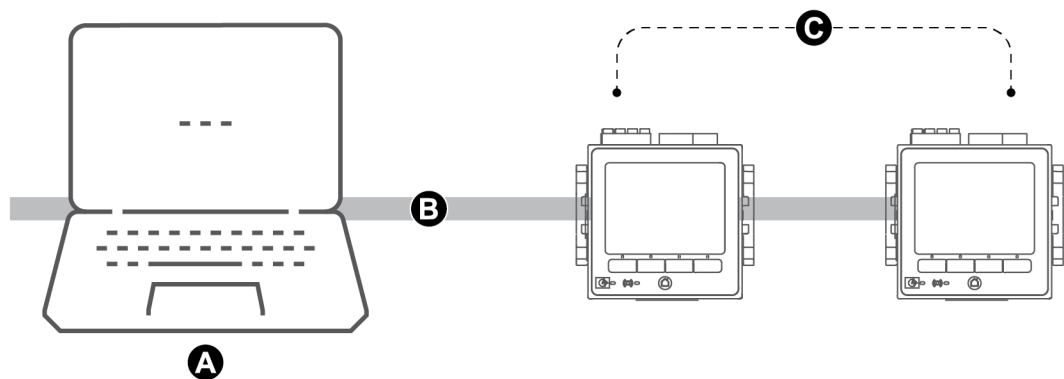

A	Computer connected to the network with IPv6 enabled
B	LAN / WAN (Local Area Network / Wide Area Network), common subnet, no routers
C	Meters with self-discovery over Ethernet connected to the network

¹These protocols must be enabled for Modbus gateway functionality.

²These are used for the meter's webpages.

Considerations for using self-discovery over Ethernet

- For self-discovery, the meter must be connected directly to the network using only a cable or switches, and not going through a router.
- You must use a computer running Windows 7 or later with IPv6 enabled to use self-discovery over Ethernet.
- The computer and the meter must be on the same subnet.
- You do not need to configure your meter's IP address for self-discovery over Ethernet. An IPv6 address is automatically generated from your meter's MAC address and self-discovery takes place over IPv6.

Accessing the meter through self-discovery

Use Windows Explorer to locate and access the meter on your Local Area Network (LAN).

NOTE: Some networks restrict device self-discovery over a wireless connection. If this is the case, make sure your computer is connected to the network using an Ethernet cable.

To access the meter through self-discovery:

1. Connect the meter's Ethernet port to the LAN.
2. Start Windows Explorer.
3. Click Network.
The connected network devices display.
4. Locate your meter with the name <Device Name>-<Last 6 digits of MAC address>.
5. Double-click the icon to open the meter webpages.

Ethernet configuration

To use Ethernet communications, you must configure your device's IP settings.

You need to enter network information for any Ethernet servers used by the device (for example, a DNS or email server). Contact your network system administrator for your IP address and other Ethernet network configuration values.

NOTE: For meters that do not have a display, you must connect your meter directly to your computer to set a unique IP address for each device or configure the meter to use a DHCP server to acquire IP addresses.

It is recommended that you test your communications with the meter after changing any communications-related settings (for example, communicating with the meter using the fully-qualified domain name if using DNS or with assigned addresses after these are provided by the DHCP server). In addition, make sure that any software or other devices communicating with the meter are using the new settings.

Initial Ethernet configuration versus changing existing Ethernet settings

There are two scenarios when configuring your meter's Ethernet communications settings: initial configuration and changing the existing addresses when the meter is in use.

- Initial configuration: Configure your device's Ethernet settings manually using the display or by connecting your meter directly to your computer and using a web browser to access the device's webpages. Alternately, you can connect your meter to the network and configure it to use a DHCP server to acquire an IP address.

NOTE: It is recommended during initial configuration that you use a connection method other than the one you are trying to configure. For example, if you are configuring DHCP IPv4 settings, connect to the meter using the IPv6 Link Local address or a serial connection. This allows you to configure the meter without being disconnected.

- Changing existing IP settings: After the meter's Ethernet port is configured and connected to the LAN, you can use ION Setup to configure meter settings, in addition to using the display or meter webpages.

In either case, modify your meter's Ethernet settings to those provided by your network system administrator before connecting the device to your local area network (LAN).

IP address format and ranges

When you set your meter's IPv4 or IPv6 addresses, make sure you use the correct format and valid ranges.

Protocol	Format
IPv4	0.0.0.0 to 255.255.255.255
IPv6	:: to FFFF:FFFF:FFFF:FFFF:FFFF:FFFF:FFFF:FFFF The double colon indicates that gaps are filled with zeroes to make the IPv6 address the correct length (32 hexadecimal numbers)

All meters ship from the factory with the IPv6 global address and IPv6 gateway undefined (set to "::"). To communicate with the meter using IPv6 outside the local network, you must configure these settings manually or use DHCP to assign the addresses to the meter. Within the local network, you can use the meter's IPv6 Link Local address.

IP addresses and network port numbers

To specify a port for an outgoing IP address, append a colon then the port number to the end of the IP address. For IPv6 addresses, enclosed the address in square brackets then add the port number. For example, to specify the default port for SFTP (port 22):

- IPv4: 169.254.0.10:22
- IPv6: [FE80::260:78FF:FE04:5943]:22

Configurable Ethernet settings

NOTE: Some additional Ethernet settings are available in the Advanced Ethernet menu in ION Setup and on the meter webpages.

“W” indicates the setting can be configured (written) while “R” indicates it is read-only.

Ethernet configuration settings

Setting	Display	ION Setup	Webpages
IPv4 address	W	W	W
IPv4 Subnet mask	W	W	W
IPv4 Default gateway	W	W	W
IPv4 Assignment Mode (DHCP/Stored)	W	W	W
IPv6 Assignment Mode (DHCP/Stored)	W	W	W
Ethernet Device name	R	W	W
Domain name	R	W	W
IPv6 enabled	W	W	W
IPv6 Link Local Address	R	R	R
IPv6 global address	R	W	W
IPv6 gateway	R	W	W
Ethernet Rx timeout	—	W	W
Modbus TCP timeout	—	W	W
Modbus gateway	—	W	—
MAC address	R	R	R
Ethernet primary DNS	R	W	W
Ethernet secondary DNS	R	W	W

Configuring IPv4 / IPv6 communications settings using ION Setup

You can configure your device’s IPv4 and IPv6 address settings, such as stored addresses or address assignment mode, using ION Setup.

When configuring communications parameters, ensure you maintain at least one communication path that allows full access to your device; otherwise, you may permanently lose the ability to change your device’s configuration and access additional data.

NOTICE

LOSS OF ACCESS

Ensure you maintain sufficient access to communicate with and configure your device.

Failure to follow these instructions can result in loss of access to the device.

Contact your network system administrator for your IP addresses and other Ethernet network configuration values.

To configure IPv4 / IPv6 communications settings using ION Setup:

1. Start ION Setup.
2. Open the **Setup Assistant** for your device.
3. Click **Communications > Basic Ethernet > IPv4 (or IPv6)**.
4. Select the IP address then click **Edit**.
5. Select your IP address assignment mode.

IPv4

Selection	Mode	Description
Use DHCP to obtain an IPv4 address	DHCP	The meter acquires its IP addresses from your network's DHCP server. The Device Name and Domain Name fields are used to define the meter's fully-qualified domain name (FQDN).
Use the following IPv4 address	Stored	The meter uses the IP addresses that you manually enter for IPv4 (address, subnet mask and gateway).

For IPv6, select the **IPv6 Enabled** check box to enable IPv6 communications or clear it to disable IPv6 communications.

NOTE: The IPv6 Link Local address is factory set and is read-only.

IPv6

Selection	Mode	Description
Use DHCP to obtain an IPv6 address	DHCPv6	The meter acquires its IP addresses from your network's DHCPv6 server. The Device Name and Domain Name fields are used to define the meter's fully-qualified domain name (FQDN).
Use the following IPv6 address	Stored	The meter uses the IP addresses that you manually enter for IPv6 (global address and default gateway).

You can have different assignment modes for IPv4 and for IPv6.

6. Configure the settings for the selected mode then click **OK**.

The changes are saved to the meter. If ION Setup detects that the connection information is already in use, you are prompted to confirm the change.

7. Click **Yes** to confirm the change or **No** to cancel.

An example of an instance where you might want to confirm the change is if you are programming the meter to replace another meter already in service.

DHCP settings available using ION Setup

Parameter	Value	Description
Device name	Contact your local network administrator for parameter values.	The Ethernet device name is used by DPWS for self-discovery over Ethernet and as the hostname to uniquely identify your meter for DHCP and DNS. By default, this is set to the meter model plus the last six-digits of the MAC address.
Domain name	Contact your local network administrator for parameter values.	The Ethernet domain name for the network that the meter resides on.

Stored IPv4 settings available using ION Setup

Parameter	Value	Description
IP address	Contact your local network administrator for parameter values.	The IP address of your device.
Subnet Mask	Contact your local network administrator for parameter values.	The subnet IP address of your network.
Gateway	Contact your local network administrator for parameter values.	The gateway IP address of your network.

Stored IPv6 address settings available using ION Setup

Parameter	Value	Description
Global Address	Contact your local network administrator for parameter values.	The Internet protocol address of your device.

Parameter	Value	Description
Default Gateway	Contact your local network administrator for parameter values.	The address the meter uses to route communications to a different network or subnet. If you do not set this or the address is incorrect, you may see slow communications or communications errors.

ION Setup reconnection

If you change the settings for the Ethernet connection method you are currently using to connect to the meter, ION Setup tries to reconnect to the meter using the updated information. You can view the process in the **Device reconnection** dialog box that appears.

- If ION Setup can successfully communicate using the new setting, this setting appears in the **IP Address** drop-down list box and the check box is selected. Click **OK** to copy this information into the **IP address** field in Device Properties. ION Setup will now use this address to communicate with the device.
- If ION Setup cannot successfully communicate using the new setting, the new address appears in the **IP Address** but the check box is not selected. Either select the check box and click **OK** (for example, you may want to use the new setting if you are replacing a meter in service) OR select another address option from the drop-down list box. Click **Test** to check that ION Setup can communicate with the meter using the new address, select the check box, then click **OK**.

Configuring basic Ethernet settings using ION Setup

To configure your device's basic Ethernet settings using ION Setup:

1. Start ION Setup.
2. Open the **Setup Assistant** for your device.
3. Click **Communications > Basic Ethernet > TCP/IP**.
4. Select a setting and then click **Edit**.

NOTE: Contact your network system administrator for the appropriate values.

General Ethernet settings available using ION Setup

Parameter	Value	Description
Ethernet device name	configurable	This name is associated with your meter when using DPWS. By default, it is the meter type and the last 6 characters of its MAC address.

Parameter	Value	Description
Rx timeout	configurable	Specifies the number of seconds the meter waits for communication acknowledgments.
Modbus TCP Timeout	configurable	Specify number of seconds the meter waits before disconnecting an idle Modbus TCP connection.
Modbus Gateway	Disabled COM1 (CM1 Protocol)	Specify the port on which Modbus Gateway sends/receives Modbus TCP requests. For Modbus Gateway to function properly, the serial port protocol must be set to Modbus Master. For example, change CM1 Protocol from factory to Modbus master.
MAC address	Read-only	The media access control (MAC) address is factory set and is for reference only.

Configuring basic Ethernet settings using the meter webpages

You can use the meter webpages to configure the IPv4, IPv6 and TCP/IP settings for the meter.

When configuring communications parameters, ensure you maintain at least one communication path that allows full access to your device; otherwise, you may permanently lose the ability to change your device's configuration and access to additional data.

NOTICE

LOSS OF ACCESS

Ensure you maintain sufficient access to communicate with and configure your device.

Failure to follow these instructions can result in loss of access to the device.

Contact your network system administrator for your IP addresses and other Ethernet network configuration values.

To configure basic Ethernet setting using the meter webpages:

1. Connect to your meter's webpages.

Until you configure other Ethernet connection settings, you can connect to the meter using its default IPv4 address or its IPv6 link local address, or by using self-discovery over Ethernet by double-clicking the meter's network icon.

2. Navigate to **Setup > Ethernet**.
3. Enter the appropriate value for the settings.
4. Click **Advanced Settings** to configure additional Advanced Ethernet settings, such as timeouts and enabling/disabling certain protocols over Ethernet, if needed.

- Click **Apply**.

NOTE: If you are changing the address you used to access the webpages, you will need to reconnect to the webpages after you click **Apply**.

Ethernet settings available using the webpages

Parameter	Value	Description
MAC address	Read-only	The media access control (MAC) address is factory set and is for reference only.
Ethernet device name	configurable	The Ethernet device name is used by DPWS for self-discovery over Ethernet and as the hostname to uniquely identify your meter for DHCP and DNS. By default, this is set to the meter model plus the last six-digits of the MAC address.
Domain name	Contact your local network administrator for parameter values.	The Ethernet domain name for the network that the meter resides on.
Primary DNS	Contact your local network administrator for parameter values.	The IP address of your network's primary DNS server, if your network uses DNS.
Secondary DNS	Contact your local network administrator for parameter values.	The IP address of your network's secondary DNS server, if your network uses DNS.

IPv4 settings available using the webpages

Parameter	Value	Description
IPv4 Assignment mode	Stored DHCP	Stored: The meter uses the IP addresses that you manually enter for IPv4 (address, subnet mask and gateway). DHCP: The meter acquires its IP addresses from your network's DHCP server.

Parameter	Value	Description
Stored IPv4 address	Contact your local network administrator for parameter values.	The Internet protocol address of your device.
Stored IPv4 Subnet Mask	Contact your local network administrator for parameter values.	The Ethernet IP subnetwork address of your network.
Stored IPv4 Gateway	Contact your local network administrator for parameter values.	The Ethernet IP gateway address of your network.

The webpage also displays the acquired IPv4 settings if the Assignment mode is set to DHCP.

NOTE: To disable communications using IPv4, set the Assignment mode to Stored and the IPv4 Address to 0.0.0.0.

IPv6 settings available using the webpages

Parameter	Value	Description
IPv6 Assignment Mode	Stored	Stored: The meter uses the IP addresses that you manually enter for IPv6 (Global address, gateway address).
	DHCPv6	DHCPv6: The meter acquires its IP addresses from your network's DHCP server.
IPv6 Link Local Address	Read-only	The IPv6 Link Local address is factory set and is read-only.
Stored IPv6 Global Address	Contact your local network administrator for parameter values.	The Internet protocol address of your device.
Stored IPv6 Gateway	Contact your local network administrator for parameter values.	The address the meter uses to route communications to a different network or subnet. If you do not set this parameter or the address is incorrect, it may result in slow communications or communications errors.

The webpage also displays the acquired IPv6 settings if the Assignment mode is set to DHCP.

NOTE: To disable communications over IPv6, set **Enable IPv6** in **Advanced Settings** to **No**.

NOTE: You must enclose an IPv6 address in square brackets when typing it in a web browser, for example: “http://[fe80::260:78ff:fe04:5943]”.

Configuring Ethernet communications settings using the display

You can configure basic Ethernet communications settings using the display.

Obtain your meter’s IP address and other network information from your network administrator or IT department before you begin.

You can use the display to select the IP address assignment mode for IPv4 and IPv6, configure stored IPv4 addresses, and view other settings. To configure the Ethernet settings that are not available on the display or are read-only, use the meter’s webpages or ION Setup.

1. Press **Setup Menu > Communications Setup**.
2. Scroll through the screens until you reach the setting you want to configure then press the **Edit** button.
3. Select the IPv4 or IPv6 **Assignment Mode**, if required.

Option	Description
Stored	The meter uses the IP addresses that you manually enter for IPv4 (address, subnet mask and gateway) and IPv6 (Global address, gateway address).
DHCP/DHCPv6	The meter acquires its IP addresses from your network’s DHCP server.

You can have different assignment modes for IPv4 and for IPv6.

If you set the **IPv4 Assignment Mode** to **Stored**, continue with the remaining steps to configure stored IPv4 addresses. If you are using addresses acquired from a DHCP server, press the down arrow to view the assigned addresses.

4. Go to the **Stored IPv4 Address Setup** screen and press **Edit**.
5. Configure your meter’s stored IPv4 Addresses, as required.

Stored IPv4 address settings available using the display

Parameter	Values	Description
IP Address	Contact your local network administrator for parameter values.	Sets the IP address for the meter Your meter’s default IP address is 169.254.0.10
Subnet Mask	Contact your local network administrator for parameter values.	Used if subnetting applies to your network Your meter’s default subnet address is 255.255.0.0

Parameter	Values	Description
Gateway	Contact your local network administrator for parameter values.	Used in networks with multiple segments Your meter's default gateway address is 0.0.0.0
MAC Address	Read-only	Your meter's media access control (MAC) address

DHCP

The meter can function as a DHCP (Dynamic Host Configuration Protocol) client, allowing a DHCP server to assign IP addresses to the meter.

The meter supports assignment of the following addresses by a DHCP server when the Assignment Mode is set to DHCP:

- IPv4 IP Address
- IPv4 Subnet mask
- IPv4 Gateway
- IPv6 Global Address
- IPv6 Gateway

Considerations for using DHCP

- It is recommended that you also set up a DNS server and configure software and other devices to use the meter's name to communicate with it. Alternatively, you can configure the DHCP server to always provide the same address to the meter.
- When you switch the assignment mode from DHCP to Stored, the meter reverts to using its default IP addresses as the Stored addresses.
- When you switch the assignment mode from Stored to DHCP, the acquired addresses display as **None** until the meter receives addresses from the DHCP server.
- When using IPv6, the meter's fully-qualified domain name (FQDN) is not sent to the DHCP server. It is important that you make sure what is configured on the meter matches what is configured on your network.
- If the meter is not able to communicate to the DHCP server:
 - When using IPv4, the meter will try to connect to the DHCP server for approximately one minute. If the meter cannot connect to the DHCP server, it will revert to the default IP address, but the Assignment Mode will remain DHCP.
 - When using IPv6, the meter will continue to try to connect to the DHCP server, even if it does not receive an address.

NOTE: If the DHCP server has not assigned an IP address and you need to reconnect to the meter, use the meter's IPv6 link local address.

- For IPv4, if the meter's fully-qualified domain name (FQDN) is not found on the DHCP server, an event is logged in the event log. For IPv6, if the meter's fully-qualified domain name (FQDN) is not found on the DHCP server, no event is logged; this is important to keep in mind when troubleshooting communications issues in a system using DHCP.

Meter domain name

You can configure the meter as a DNS client in systems using a DNS server.

Domain name resolution (DNS)

A DNS (domain name system) server maps domain names to IP addresses. If you configure the meter to use a DNS server, the meter can communicate with other network resources using their domain names, rather than their IP addresses, and vice versa. For example, if your network has an SMTP server with the domain name of smtp.company.com, you can enter smtp.company.com as the SMTP Server address in the meter's communications settings.

The meter's fully-qualified domain name (FQDN)

To allow other network resources to communicate to the meter using its domain name, you must configure the meter's Ethernet Device Name setting to match that used by the DNS server. The meter's fully-qualified domain name is its Ethernet name plus its Domain name. For example, if the meter's Ethernet name is ElectricityHQ and its Domain name is companyXYZ.com, the FQDN will be ElectricityHQ.companyXYZ.com.

NOTE: This domain name is used for both IPv4 and IPv6 communications. It is used to identify the meter in a system using DNS and to identify the meter when using DPWS for self-discovery over Ethernet.

Network protocol control

The network protocol control feature allows you to enable, disable or change the port number of the network protocols supported on your meter.

Disabling unused ports is considered a cybersecurity best practice to help minimize unauthorized access to your meter.

NOTE: The protocol port number may not be configurable on all protocols.

Managing network protocol control using ION Setup

Use ION Setup to enable, disable or change the port number of the network protocols supported on your meter.

When configuring communications parameters, ensure you maintain at least one communication path that allows full access to your device; otherwise, you may permanently lose the ability to change your device's configuration and access to additional data.

NOTICE

LOSS OF ACCESS

Ensure you maintain sufficient access to communicate with and configure your device.

Failure to follow these instructions can result in loss of access to the device.

To manage network protocol control using ION Setup:

1. Open the **Setup Assistant** for your meter.
2. Click **Communications > Advanced Ethernet > Protocols**.
3. Select a protocol from the list and click **Edit**.
4. Select the **Enabled** check box to enable the port. Clear the check box to disable the port.

NOTE: The IEC61850 port is enabled when a valid CID file is uploaded to the meter. The port is disabled by removing the CID file.

NOTE: For EtherGate functionality, the EtherGate protocol must be enabled and the applicable serial port set to **EtherGate**.

5. Select a port number from the **Port Number** drop-down list box or by clicking in the **Port Number** field and entering a port number.
6. Click **OK**.

If multiple ports are set to the same number, ION Setup responds with a message indicating that the port is already in use by another protocol.

Managing network protocol control using the meter webpages

Use the meter webpages to enable, disable or change the port number of the network protocols supported on your meter.

The Setup tab contains configurable elements for enabling, disabling, and changing the port numbers for your network protocols.

When configuring communications parameters, ensure you maintain at least one communication path that allows full access to your device; otherwise, you may permanently lose the ability to change your device's configuration and access to additional data.

NOTICE

LOSS OF ACCESS

Ensure you maintain sufficient access to communicate with and configure your device.

Failure to follow these instructions can result in loss of access to the device.

To manage network protocol control using the meter webpages:

1. Open a web browser and enter your meter's IP address in the address bar.
The webpage login is displayed.
2. Enter your login credentials.
3. Navigate to **Setup > Ethernet**.
4. Click **Advanced Settings** at the bottom of the screen.
5. Select **YES** or **NO** to enable or disable each configurable protocol.
6. Enter the port number for each configurable protocol.
7. Click **Apply** to send these settings to your meter.

Managing network protocols using the display

The Ethernet Port Enable Setup allows you to enable or disable your network protocols through the display.

When configuring communications parameters, ensure you maintain at least one communication path that allows full access to your device; otherwise, you may permanently lose the ability to change your device's configuration and access to additional data.

NOTICE

LOSS OF ACCESS

Ensure you maintain sufficient access to communicate with and configure your device.

Failure to follow these instructions can result in loss of access to the device.

NOTE: You cannot change the Ethernet port number assignments through the display.

To manage network protocol control using the display:

1. Press the **Home** button on the display.
2. Navigate to **Setup Menu > Ethernet Port Enable Setup**.
3. Press **Edit**. Enter your meter's password, if prompted.
4. Press the up or down buttons to navigate available Ethernet protocols. A gray bar appears behind the active selection.
5. Press the up and down buttons simultaneously.
6. Press **Select** to accept the change.
7. Press **Select** to confirm.

Serial communications

The meter supports serial communications through its onboard RS-485 ports. Your meter supports the 4-wire RS-485 option module through use of the existing Com1 port.

RS-485

In an RS-485 network, there is one master device, typically an Ethernet to RS-485 gateway. It provides the means for RS-485 communications with multiple slave devices (for example, meters). For applications that require only one dedicated computer to communicate with the slave devices, a USB to RS-485 converter can be used to connect to the master device.

Up to 32 devices can be connected on a single RS-485 bus.

RS-485 wiring

Connect the devices on the RS-485 bus in a point-to-point configuration, with the (+) and (-) terminals from one device connected to the corresponding (+) and (-) terminals on the next device.

NOTE: If using the 4-wire RS-485 option module follow the wiring instructions in your installation guide. Your wiring may depend on serial or gateway configuration.

RS-485 cable

Use a shielded 2 twisted pair or 1.5 twisted pair RS-485 cable to wire the devices. Use one twisted pair to connect the (+) and (-) terminals and use the other insulated wire to connect the C terminals.

The total distance for devices connected on an RS-485 bus should not exceed 1200 m (4000 ft).

RS-485 terminals

C	Common. This provides the voltage reference (zero volts) for the data plus and data minus signals
	Shield. Connect the bare wire to this terminal to help suppress signal noise that may be present. Ground the shield wiring at one end only (either at the master or the last slave device, but not both).
-	Data minus. This transmits/receives the inverting data signals.
+	Data plus. This transmits/receives the non-inverting data signals.

NOTE: If some devices in your RS-485 network do not have the C terminal, use the bare wire in the RS-485 cable to connect the C terminal from the meter to the shield terminal on the devices that do not have the C terminal.

RS-485 configuration

Before connecting your device to the RS-485 bus, use ION Setup , meter webpages or the display to configure your meter's default RS-485 settings.

Your meter has one RS-485 connection.

The RS-485 connection must have a unique unit identifier (Unit ID) and have the following settings match the rest of the devices on the RS-485 bus:

- Protocol
- Baud rate
- Parity and stop bits

You can configure the following settings to help optimize communications performance:

- RTS delay
- RS-485 bias

You can use a communications converter (USB to RS-485 or RS-232 to RS-485) or an Ethernet gateway device to connect to your meter.

RS-485 bias

You can use the RS-485 bias setting to fine-tune communications.

Set the RS-485 bias to ON when the meter is acting as a master over RS-485 communications and set the RS-485 bias to OFF when the meter is acting as a slave. You can configure RS-485 biasing through ION Setup, the meter webpages or the display.

Serial protocols and ports

Your meter supports serial communications protocols on the RS-485 ports.

- | | |
|---|--|
| <ul style="list-style-type: none"> • ION • Modbus RTU • Modbus Master • DNP 3.0 | <ul style="list-style-type: none"> • EtherGate • GPS: Truetime/Datum ¹ • GPS: Arbiter ¹ • GPS: Arbiter-Vorne ¹ • None ² |
|---|--|

1 – These protocol settings are used for connecting to a GPS receiver communicating in serial ASCII format.

2 – This protocol setting stops communications using this port.

Configuring serial communications settings using ION Setup

Use ION Setup to configure the meter's serial communications settings.

Before configuring serial parameters, make sure you have a unique unit ID for your meter and know the serial network settings (protocol, baud rate, parity and stop bits).

To configure the meter's serial communications settings using ION Setup:

1. Start ION Setup.
2. Open the **Setup Assistant** for your device.
3. Click **Communications > Serial Settings**.

4. Select **Com1**.
5. Select a setting and then click **Edit** to configure the setting to match your communications system.

Serial communications settings available using ION Setup

Parameter	Values	Description
Protocol	ION, Modbus RTU, Modbus Master, DNP v3.00, EtherGate, GPS: Truetime/Datum, GPS: Arbiter, GPS: Arbiter-Vorne, Factory, None	Sets the communications protocol for your meter's RS-485 port The NONE setting stops communications using this port.
Baud Rate	2400, 4800, 9600, 19200, 38400, 57600, 115200	Sets the data rate, in bits per second
Rx Timeout ¹	0.1–15	Sets the transmit delay (timeout for receiving an entire message from a device) in seconds.
Unit ID	1–9999	Sets the meter's unique ID on the RS-485 network Note: Modbus serial device range 1 to 247
Serial Port	8N1, 8N2, 8E1, 8E2, 8O1, 8O2	Sets the parity and stop bits for the port
RS485 Bias	OFF, ON	Turns on biasing when mastering devices over the RS-485 port

Configuring serial communications settings using the webpages

You can use the meter's webpages to configure your serial communications settings.

Before configuring serial parameters, make sure you have a unique unit ID for your meter and know the serial network settings (protocol, baud rate, parity and stop bits).

To configure the meter's serial communications settings using the meter webpages:

1. Connect to your meter's webpages using the meter's IPv4 address or its IPv6 link local address, or use self-discovery then double-clicking the meter's network icon.
2. Navigate to **Setup > Serial Port**.
3. Enter the appropriate value for the settings.
4. Click **Advanced Settings** to configure additional settings, if needed (for example, RS485 biasing or Rx Timeout).

¹Only applies to a subset of protocols.

Basic serial communications settings available using the webpages

Parameter	Values	Description
Protocol	ION, Modbus RTU, Modbus Master, DNP v3.00, EtherGate, GPS: Truetime/Datum, GPS: Arbiter, GPS: Arbiter-Vorne, Factory, None	Sets the communications protocol for your meter's RS-485 port The NONE setting stops communications using this port.
Baud Rate	2400, 4800, 9600, 19200, 38400, 57600, 115200	Sets the data rate, in bits per second
Unit ID	1–9999	Sets the meter's unique ID on the RS-485 network NOTE: Modbus serial device range 1 to 247

Advanced serial communications settings available using the webpages

Parameter	Values	Description
RTS Delay	0–1	The delay in seconds before the transmission of the packet.
Rx Timeout ¹	0.1–15	Sets the transmit delay (timeout for receiving an entire message from a device) in seconds.
Serial Port	8N1, 8N2, 8E1, 8E2, 8O1, 8O2	Sets the parity and stop bits for the port
RS485 Bias	OFF, ON	Turns on biasing when mastering devices over the RS-485 port

Configuring serial communications using the display

You can configure your meter's basic serial communications settings using the display.

Before configuring serial parameters, make sure you have a unique unit ID for your meter and know the serial network settings (protocol, baud rate, parity and stop bits).

To configure the meter's serial communications settings using the display:

1. Press the **Home** button.
2. Press **Setup Menu > Communications Setup**.

¹Only applies to a subset of protocols.

3. Press the up and down buttons to scroll and select **COM1 Setup**.
4. Configure your meter's serial settings as required.

Serial communications settings

Parameter	Values	Description
Protocol	ION, Modbus RTU, Modbus Master, DNP v3.00, EtherGate, GPS: Truetime/Datum, GPS: Arbiter, GPS: Arbiter-Vorne, Factory, None	Sets the communications protocol for your meter's RS-485 port The None setting stops communications using this port.
Baud Rate	2400, 4800, 9600, 19200, 38400, 57600, 115200	Sets the data rate, in bits per second
Rx Timeout	0.1–15	Sets the transmit delay in seconds
Unit ID	1–9999	Sets the meter's unique ID on the RS-485 network NOTE: Modbus serial device range 1 to 247
Serial Port	8N1, 8N2, 8E1, 8E2, 8O1, 8O2	Sets the parity and stop bits for the port
RS485 Bias	OFF, ON	Turns biasing off or on when mastering devices over the RS-485 port

Disabling serial communications ports

You can disable serial communications ports using ION Setup, meter webpages, or the display.

Disabling serial communications using ION Setup

NOTE: Disabling unused ports is considered a cybersecurity best practice to help minimize unauthorized access to your meter.

To disable serial communications using ION Setup:

1. Open the **Setup Assistant** for your meter.
2. Click **Communications > Serial Settings**.
3. Click the **Com1** tab.
4. Select **Protocol** and click **Edit**.
5. Select **None** from the drop-down list box and click **OK**.

Disabling serial communications using the webpages

NOTE: Disabling unused ports is considered a cybersecurity best practice to help minimize unauthorized access to your meter.

To disable serial communications using ION Setup:

1. Open a web browser and enter your meter's IP address in the address bar. The webpage login prompt is displayed.
2. Enter your login credentials.
3. Navigate to **Setup > Serial Port** and expand the **Basic Settings** section.
4. Choose **COM1/ RS485#1 - Protocol** from the drop-down list box and select **None** to disable the port.
5. Click **Apply**. When prompted, click **Yes** to save the changes.

Disabling serial communications using the display

NOTE: Disabling unused ports is considered a cybersecurity best practice to help minimize unauthorized access to your meter.

To disable serial communications using ION Setup:

1. Press the **Home** button.
2. Press **Setup Menu > Communications Setup**.
3. Press **Select**.
4. Scroll then select **COM1 Setup**.
5. Press the navigation button to scroll and select **Protocol**.
6. Press the **Edit** button. Enter user credentials if prompted.
7. Press the down button and then select **None** to disable the port.
8. Press the **Select** button when you are finished. If prompted, press **Select** button again to accept the changes.

ION

ION is the native protocol and architecture of your meter.

The basic building blocks of ION architecture are the ION modules, each of which is specialized to perform a specific task and contains data and instructions on how to manage that data. ION modules are combined (linked) together to create the meter's functions and features. ION modules that are linked together to perform a specialized task are called a framework, such as the Power Quality framework. These different functional frameworks are then grouped together to define the entire meter and are collectively referred to as the device template.

Your meter ships with a default device template which provides extensive capabilities. You can also configure your meter's template to modify your meter's existing functions or to create new functions.

See *ION Reference*, available from www.se.com, for further information about ION architecture and a detailed description of the different ION modules. See the *ION Device Template Reference*, available from www.se.com, for details on the modules and their configuration in your meter's default template.

Modbus

Modbus is a master/slave communications protocol where the master initiates transactions and the slave(s) responds with the requested information or action.

Your device can function as a Modbus slave or Modbus master, depending on how it is configured. Your device comes with Modbus slave functionality configured and ready to use. You can add custom Modbus information to the default Modbus slave data provided by your device.

Key terms

Term	Definition
Modbus gateway	A communications method that lets you communicate through an Ethernet gateway device to a Modbus serial network connected to that device.
Modbus master	A device that issues commands and receives responses from Modbus slave devices. Serial Modbus networks can only have one Modbus master per network.
Modbus RTU	Serial Modbus protocol format; Modbus RTU transmits data using binary. Master and slave devices must use the same format.
Modbus register/address	Identifies the data to read/write. Modbus register maps are available for Modbus slave devices and detail the information available from the slave device. More than one register may be used to store a single value.
Modbus slave	A device that responds to Modbus commands and performs actions or provides information back to the Modbus master. Most Modbus networks contain multiple slave devices.
Modbus TCP	The Ethernet Modbus protocol format.
Modbus unit ID	The identifier for a slave Modbus device.

You can download your device's Modbus map from www.se.com and get additional information about the Modbus protocol from www.modbus.org.

Modbus best practices for Ethernet

For your meter to operate as an Ethernet Modbus device, you must complete some prerequisite configuration.

NOTE: You do not need to perform any Modbus-specific configuration for your meter to function as a Modbus slave device over Ethernet.

Prerequisite	Description
Ethernet	All devices must have a working Ethernet connection.
IP address	All devices must have a unique IP address.
Port	All devices must be communicating over Ethernet port 502 for Modbus TCP.

NOTE: Devices supporting multiple simultaneous Modbus TCP connections can have communications delays. Adjust your network timeout settings to accommodate this.

Modbus best practices for serial

For your meter to operate as a serial Modbus device, you must complete some prerequisite configuration.

Prerequisite	Description
Wiring	The device's serial connection must be wired correctly. The Modbus slave devices must have communications wiring to the Modbus master.
Protocol	Slave: for your meter to be a serial Modbus slave, the meter's protocol must be set to Modbus RTU. Master and slave devices must use the same format. Master: For your meter to be a serial Modbus master, the meter's protocol must be set to Modbus Master.
Baud rate	The baud rate must be the same for all devices on the serial Modbus network.
Stop bits and parity	The communication stop bits and parity (for example, 8N1) must be the same for all devices on the serial Modbus network.
Unit ID	Each device on the serial Modbus network must have a unique unit ID (also called the device address). Note: Modbus serial device range 1 to 247

Your meter as a Modbus master

Your meter as a Modbus master with Ethernet Modbus slave devices

Your meter can function as a Modbus master with Ethernet Modbus slave devices.

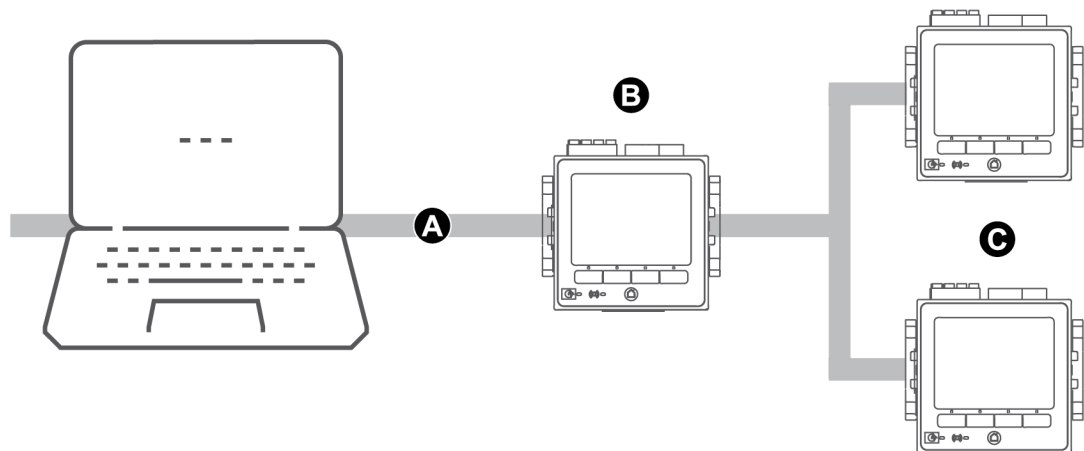

A	Ethernet
B	Your meter
C	Modbus slaves

For Modbus mastering, you must add the Modbus slave devices using ION Setup.

Your meter as a Modbus master with serial Modbus slave devices

Your meter can function as a Modbus master with serial Modbus slave devices

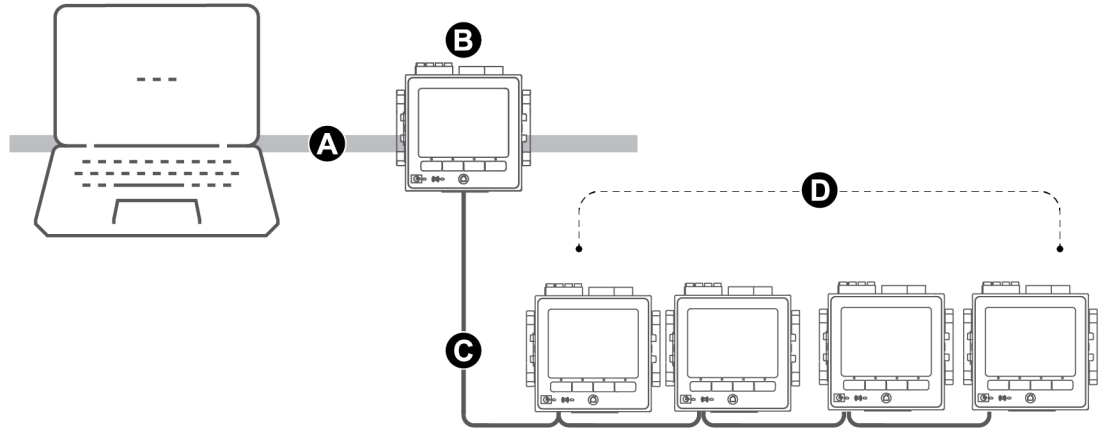

A	Ethernet
B	Your meter
C	RS-485 Modbus RTU
D	Modbus slaves

For Modbus mastering, you must add the Modbus slave devices using ION Setup.

Modbus master best practices

For your meter to operate as a Modbus master, you must complete some prerequisite configuration.

NOTE: These settings are required in addition to the serial or Ethernet Modbus prerequisites.

Prerequisite	Description
Modbus slave devices	All Modbus slave devices must be communicating and appropriately configured.

Prerequisite	Description
Protocol	<ul style="list-style-type: none"> Modbus mastering serial devices: the master's serial port protocol must be set to Modbus master. Modbus mastering Ethernet devices: the master must be communicating to the slave devices over Ethernet port 502. <p>NOTE: Having more than one Modbus master on a serial Modbus network may cause communication conflicts.</p>
Mastered devices	The Modbus master device must have the slave device information entered for mastering.

Configuring your meter as a Modbus master using ION Setup

You can configure your meter to Modbus master slave devices over serial or Ethernet.

Make sure your master and slave devices have the prerequisite communications wiring and configuration before configuring your meter as a Modbus master.

If the meter is a Modbus master over TCP/IP, the Modbus TCP/IP and Modbus RTU protocols must be enabled.

NOTE: Devices supporting multiple simultaneous Modbus TCP connections can have communications delays. Adjust your network timeout settings to accommodate this.

The meter as a Modbus master over TCP/IP attempts to communicate with a slave device for up to 100 seconds (as per the RFC 1122 standard) before moving on to the next slave device.

To configure your meter as a Modbus master over serial or Ethernet:

1. Start ION Setup.
2. Open the **Setup Assistant** for your meter.
3. Click **Communications > 3rd Party Protocols > Modbus Master**.
4. Click **Add** to add a Modbus slave device.
The Modbus Device dialog appears.
5. Enter the Modbus slave information:
 - Enter the Modbus slave device's name and a label suffix (if applicable).
 - Select the device type of the slave device from the **Device Type** drop-down list box.
 - Enter the unit ID of the Modbus slave device into the **Slave ID** text box.
 - Select the serial or TCP connection from the **Connected via** drop-down list box. This is the connection from the Modbus master to the slave device.
6. Click **Connections**. The Modbus Master Connections dialog appears.
7. Select the tab that corresponds to the connection you are configuring (for example, if you selected TCP Connection 1 from the **Connected via** drop-down list box, select the TCP 1 tab) and configure it based on the connection type.

Connection type	Configuration
Serial connection	Select the serial communications port that is connected to the Modbus slave devices from the Assigned Port list.
TCP connection	Enter the IP address of the Modbus slave device, making sure that the IP port is set to 502. Make sure that the Modbus RTU and Modbus TCP/IP protocols are enabled.

8. Click **OK** to return to the Modbus Device dialog.
9. Click **OK** to add the slave device. The device now appears on the list.
10. Repeat steps 4 through 9 to add all your Modbus slave devices.

Your meter as a Modbus slave

Your meter as a Modbus slave over Ethernet

Your meter can function as a Modbus slave over Ethernet.

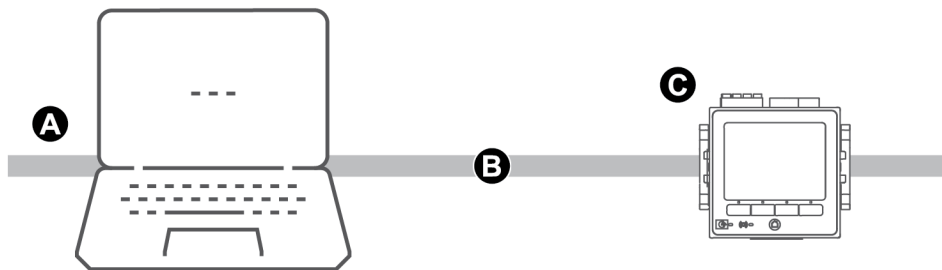

A	Modbus master
B	Ethernet Modbus TCP
C	Your meter

Your meter does not require any Modbus-specific configuration to act as a Modbus slave device over Ethernet.

Your meter as a Modbus slave on a serial network

Your meter can function as a Modbus slave on a serial network.

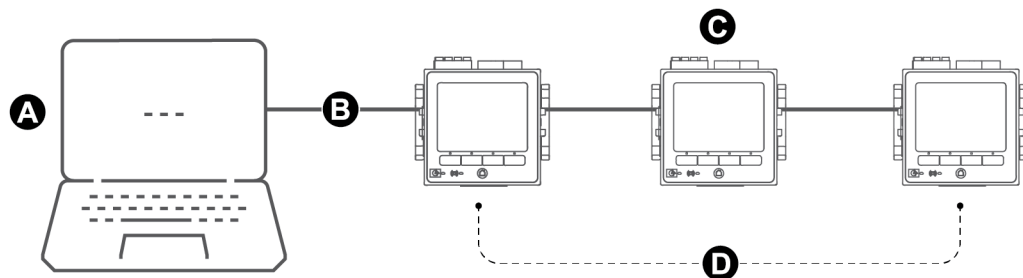

A	Modbus master
B	RS-485 Modbus RTU
C	Your meter
D	Modbus slaves

Your meter's serial connection must be wired and configured correctly. The same mode of serial communication must be used for all devices on the network.

Configuring your meter as a Modbus slave using ION Setup

To configure your meter as a Modbus slave using ION Setup:

1. Start ION Setup.
2. Open the **Setup Assistant** for your meter.
3. Click **Communications > Serial settings**. Select the tab for the serial port you want to configure.
4. Highlight the parameter and click **Edit** to configure the serial port's Modbus parameters as required.

Parameter	Setting
Protocol	Modbus RTU or Modbus Master
RS485 Bias	OFF if the meter is a Modbus slave

5. Configure the meter's other serial port parameters as required.

For Modbus mastering, you must add the Modbus slave devices using ION Setup.

See your device's Modbus map, available from www.se.com for Modbus register information.

Configuring your meter as a Modbus slave using the webpages

To configure your meter as a Modbus slave using the meter webpages:

1. Connect to your meter's webpages.
2. Navigate to **Setup > Serial Port**.
3. Expand Basic Settings or Advanced Settings and configure the serial port's Modbus parameters as required.

Parameter	Setting
Protocol	Modbus RTU or Modbus Master
RS485 Bias	OFF if the meter is a Modbus slave

4. Configure the meter's other serial port parameters as required.

For Modbus mastering, you must add the Modbus slave devices using ION Setup.

See your device's Modbus map, available from www.se.com for Modbus register information.

Configuring your meter as a Modbus slave using the display

To configure your meter as a Modbus slave using the meter display:

1. Press the **Home** button.
2. Navigate to **Setup Menu > Communications Setup**, scroll and select **COM1 Setup**.
3. Configure Modbus parameters as required.

Parameter	Setting
Protocol	Modbus RTU or Modbus Master
RS485 Bias	OFF if the meter is a Modbus slave

4. Configure the meter's other serial port parameters as required.

For Modbus mastering, you must add the Modbus slave devices using ION Setup.

See your device's Modbus map, available from www.se.com for Modbus register information.

Supported Modbus features

Your meter supports specific Modbus data classes, data formats, function codes and commands.

Modbus data classes

Class	Description
Coils	Digital bits that can be read and written to
Input status	Digital bits that can be read
Input registers	16-bit integers that can be read
Holding registers	16-bit integers that can be read and written to

Modbus data formats

Format	Type	# of Modbus registers used
Unsigned 16-bit	Integer	1
Signed 16-bit	Integer	1
Unsigned 32-bit	Integer	2
Signed 32-bit	Integer	2
Unsigned 32B-M10K	Integer	2
Signed 32B-M10K	Integer	2

Format	Type	# of Modbus registers used
IEEE float ¹	Floating point	2
Packed Boolean for inputs	Integer	1
Packed Boolean for coils	Integer	1
Unsigned 16-bit read/write	Integer	1
Signed 64 bit	Integer	4

16-bit data (one word) is transmitted with most-significant byte first and least-significant byte second.

32-bit data (two words) is transmitted with the most-significant word first and the least-significant word second.

Modbus function codes

Function	Description	Master/slave
1	Read coil status	Master and slave
2	Read input status	Master and slave
3	Read holding registers	Master and slave
4	Read input registers	Master
5	Write to a coil	Master
6	Write to a holding register	Master and slave
15	Write to multiple coils	Master
16	Write to multiple holding registers	Master and slave
17	Report slave ID (serial only)	Master and slave
43 (sub code 14)	Read device identification	Master and slave
100	Read scattered holding registers	Master and slave

Modbus commands

A Modbus master command to unit ID 0 is broadcast (sent to) all Modbus slave devices. The only supported broadcast command is preset multiple registers.

For serial Modbus networks with only one slave device, the master can send commands using the single connection, one-to-one address of unit ID 248, regardless of the slave device's actual unit ID.

Modbus implementation

Your meter's Modbus implementation includes exception codes, invalid register responses, fixed and configurable register maps, and security.

¹Meters acting as Modbus masters support two versions of IEEE float with different word orders: high/low = Big Endian, low/high = Little Endian.

Modbus exception codes

Code	Name	Description
01	Illegal function	The requested command is invalid.
02	Illegal address	This code indicates one of the following: <ul style="list-style-type: none"> The requested address is invalid for that function. The requested address is not within the valid register range for this device. The requested address is protected by device security.
03	Illegal value	This code indicates one of the following: <ul style="list-style-type: none"> The requested value is not allowed for that register in the device. The requested register is part of a multi-word value.

Modbus invalid read registers responses

Invalid type	Read response
Unmapped (unused)* register	0x8000
Reserved* register responses by type	
Signed integer 16-bit	0x8000
Unsigned integer 16-bit	0xFFFF
Signed integer 32-bits	0x80000000
Unsigned integer 32-bits	0xFFFFFFFF
Signed integer 64-bits	0x8000000000000000
Float32	0xFFC00000 (NaN = Not a number)

* IRIG-B can only be connected to one of the digital inputs located on the meter base, not an option module. Unmapped (unused) registers are registers that will never be used by the meter, and therefore have no defined format. Reserved registers have a defined format and are intended for use by the meter, its options, or its variants.

Modbus invalid write registers response

If the meter receives a write command to a Modbus register address that does not have a register mapped, the meter will not respond. No data is written or stored, and the meter will not send back a rejection to the request.

If the meter receives a write command to a read-only Modbus register address, exception code 03 (illegal value) is returned.

Fixed and configurable Modbus map

Your meter has a fixed (static) register map for meter data and a flexible, user-configured register map.

Modbus security

Your meter's onboard security options include Modbus-specific settings. These security settings may need to be configured to write Modbus data to the meter.

Modbus map

Your meter's default Modbus register information (map) is available for download from www.se.com.

The Modbus register information includes:

- Registers and mapped values
- Formats and scaling
- Additional details where applicable

NOTE: Your meter's Modbus registers are specified differently than previous devices using ION architecture. If you are configuring Modbus slave information on your meter, confirm you are using the appropriate Modbus register addressing. Refer to your meter's Modbus map for more information.

Your meter has a fixed (static) register map which contains the most common metering values. This map is defined by a series of Data Mapping modules, which also determine the values shown on the meter webpages or the display. The Data Mapping modules are named based on the type of information they map to Modbus:

Data Mapping module	Description
Data Mapping Dmd Modules	Maps kW, kVA and kVAR demand data such as kW sd del (sliding demand kilowatts delivered) as well as current demand such as I a sd (sliding demand phase A current).
Data Mapping Egy Modules	Maps kWh, kVAh and kVARh delivered and received data, including conditional, quadrant and incremental energies.
Data Mapping EN Modules	Maps present interval EN 50160 power quality compliance data.
Data Mapping EN Prev Modules	Maps previous interval EN 50160 power quality compliance data.
Data Mapping I/O Modules	Maps input metering data, alarms, resets and reset counts.

Data Mapping module	Description
Data Mapping Meas Modules	Maps measured data from the standard and high-speed Power Meter module. The Cfg Modbus Map Enable setup register may exist in this module.
Data Mapping PQ Modules	Maps power quality data such as Crest Factor, K Factor and total harmonic distortion, including IEC 61000-4-30 power quality compliance data.
Data Mapping Stats Modules	Maps statistical low, mean and high data values, such as I a mean (phase A current average value).
Data Mapping TOU Modules	Maps time-of-use (TOU) data, such as seasons, rates, and per-season demand such as kW sd rec A (sliding demand kilowatts received in season A).

You can add extra Modbus information or duplicate information that is already in the fixed map to different Modbus registers using Modbus Slave modules.

See *ION Reference*, available from www.se.com, for detailed information about Data Mapping modules and Modbus Slave modules.

Configuring custom Modbus data using ION Setup

You can add custom data to your meter's default Modbus map, completely customize your meter's Modbus map, or revert your meter's Modbus map back to its default configuration using ION Setup.

Download your meter's Modbus map information from www.se.com.

To configure custom data using ION Setup:

1. Start ION Setup.
2. Open the **Setup Assistant** for your meter.
3. Click **Communications > 3rd party protocols > Modbus Slave**.

The name of the meter's current Modbus map is displayed, along with the quantity of custom registers and their start and end addresses.

4. Select the map name and click **Edit**.

The **Modbus Slave Mode Setup** screen is displayed.

5. Select your meter's method of Modbus slave mapping. If you select **Default** or **Disabled**, click **Finish** to configure your meter and return to the **Setup Assistant**, otherwise select **Next** to access the **Modbus Slave Map Setup** screen.

Option	Description
Default	Sets your meter to use the default Modbus map. Any custom Modbus slave data is removed. NOTE: You can download your meter's Modbus map information from www.se.com .
Modified	Add Modbus information in addition to the meter's default Modbus map.
Custom	Removes the meter's default Modbus map so that all registers are available, and you can create a completely custom Modbus map. NOTE: Use this option if you want to make your meter's Modbus map identical to a device that it is replacing, for example in a retrofit application.
Disabled	Removes your meter's Modbus data map. Modbus functions are unaffected, but no meter Modbus data is available.

6. In the **Modbus Slave Map Setup** screen, you can modify parameters by clicking **Edit**, or add parameters by clicking **Add**.
The **Modbus Register** screen is displayed.
7. Configure the Modbus register information and click **OK** to return to the **Modbus Slave Map Setup** screen.
 - a. **Source:** Click **Select** and chose a source from the **Parameter Selection** screen. Select **Show all available registers** to see a complete list of the parameters available on your meter. Click **OK**.
 - b. **Address:** Enter the Modbus address that will hold the Source data.
NOTE: If you hover your mouse over the Address field, a tooltip indicates the Modbus function code and start address to send for retrieving the data.
 - c. **Format:** Select the Modbus data format from the list.
 - d. **Scaling:** Select the scaling value from the list or select **Custom** and click **Scales** to configure custom scaling.
8. In the **Modbus Slave Map Setup** screen you can click **Delete** to remove a Modbus register, **Set Name** to create a new name for the set of additional data mapped to Modbus, or **Save As** to save the additional data you have mapped to Modbus as a separate file.
9. Click **Finish** to complete your meter's Modbus slave configuration and return to the Setup Assistant.

Ethernet gateway

Ethernet gateway is a communications method that allows you to communicate through a gateway device to a serial network.

When a meter with gateway capabilities is installed on an Ethernet network, a master device (such as an energy management system) can communicate through the gateway meter to a serial network of devices connected to the gateway meter’s serial port(s). The maximum number of devices on the serial network is determined by the limitations of the gateway meter’s serial port.

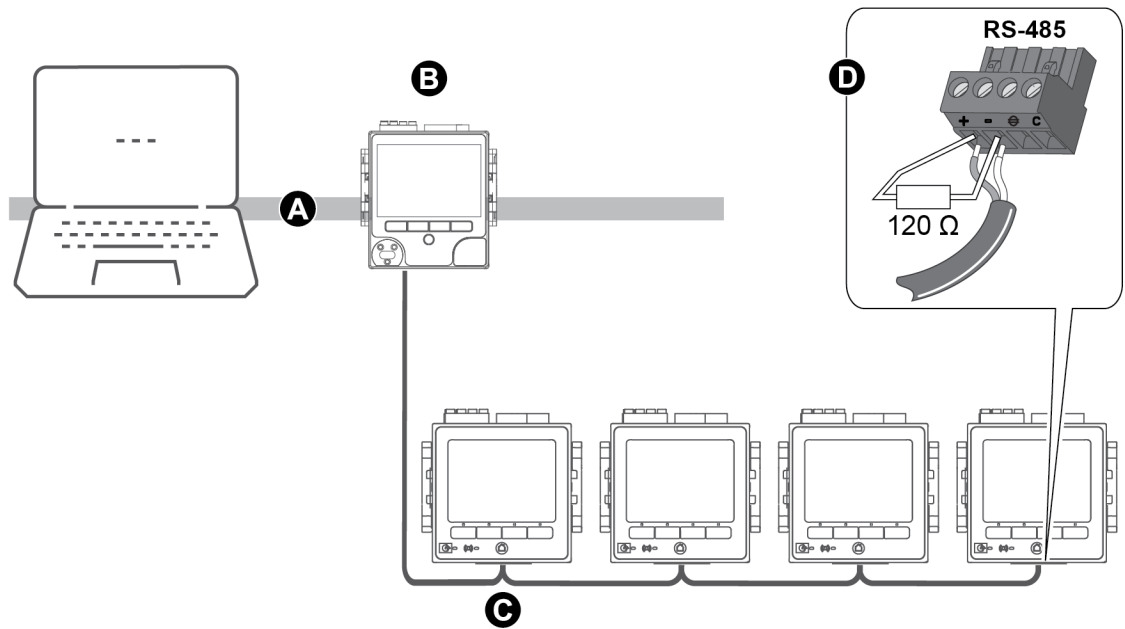

A	LAN/WAN
B	Ethernet gateway meter
C	Serial RS-485 network of devices
D	Terminating resistor

There are two types of Ethernet gateways that you can configure on your meter:

- EtherGate: a single TCP connection communicates through the gateway meter to a serial network of devices.
- Modbus gateway: up to a maximum of 32 Modbus master TCP connections communicate through the gateway meter to a serial network of Modbus devices.

EtherGate

The meter can function as an Ethernet gateway (EtherGate).

EtherGate is a protocol-agnostic communications method that lets you communicate through a gateway meter to a serial network of devices letting ION or other RTU over TCP data pass through the gateway meter to other networks, including third party systems. When a meter installed on the Ethernet network has EtherGate enabled, a master device (such as an energy management system) can communicate through the gateway meter to a serial network of devices wired to the gateway meter’s COM port. You must create an additional communications connection to the gateway meter to read its information.

NOTE: EtherGate supports only one master device.

Before proceeding, confirm the following:

- The serial network of devices are wired to the gateway meter's serial communication port.
- All serial devices are configured to have the same baud rate, serial port settings (for example, 8N1), and protocol (ION).
- Each serial device has a unique unit identifier (unit ID/address).
- Your gateway meter is communicating over Ethernet.

You can then configure the gateway meter's serial port to use the EtherGate protocol, create the EtherGate site in ION Setup or an energy management system, and add the serial devices to the EtherGate site.

Configuring EtherGate using ION Setup

To configure EtherGate communications on your meter using ION Setup:

1. Start ION Setup.
2. Open the **Setup Assistant** for your meter.
3. Click **Communications > Serial settings**.
4. Select **Com1**.
5. Highlight the parameter and click **Edit**. Enter the meter password if prompted, change the setting, then click **OK** to save the changes.

Parameter	Setting
Protocol	EtherGate
Baud Rate	Serial port settings must match the settings for all connected
Serial Port	serial devices

6. Create an Ethernet gateway site to access the serial network of devices through your gateway meter.

Configuring EtherGate using the webpages

To configure EtherGate communications on your meter using the meter webpages:

1. Connect to your meter's webpages.
2. Navigate to **Setup > Serial Port**.
3. Expand Basic Settings or Advanced Settings and modify the settings for the serial port you are configuring for EtherGate communications (**COM1 / RS485#1**).
4. Change the settings, then click **Apply**. Click **Yes** to save the changes.

Parameter	Setting
Protocol	EtherGate
Baud Rate	Serial port settings must match the settings for all connected
Serial Port	serial devices

You can use ION Setup to create an Ethernet gateway site and access the serial network of devices connected through the EtherGate meter.

Configuring EtherGate using the display

To configure EtherGate communications on your meter using the meter display:

1. Press the **Home** button.
2. Navigate to **Setup Menu > Communications Setup**.
3. Press the **Select** button.
4. Scroll then press **COM1 Setup**.
5. Highlight the parameter and press **Edit**. Enter the meter password if prompted, change the setting, then press **Select** to save the changes.

Parameter	Setting
Protocol	EtherGate
Baud Rate	Serial port settings must match the settings for all connected
Serial Port	serial devices

You can use ION Setup to create an Ethernet gateway site and access the serial network of devices connected through the EtherGate meter.

Modbus Ethernet gateway

A Modbus Ethernet gateway allows multiple Modbus masters on the LAN/WAN to connect to downstream serial Modbus slave devices.

A Modbus master device, such as an energy management system, can communicate through the gateway meter to a serial network of devices connected to the gateway meter's serial port(s). The meter receives Modbus TCP/IP data on TCP port 502, translates it to Modbus RTU then forwards it to the addressed slave device.

This functionality allows the use of monitoring software to access information from slave devices for data collection, trending, alarm/event management, analysis, and other functions.

Modbus Ethernet gateway implementation

There are some specific aspects to your meter's Modbus Ethernet gateway implementation.

A Modbus request is sent through Ethernet using Modbus/TCP to the gateway meter. If this request is addressed with the slave ID of one of the downstream serial devices, the meter forwards the message to that device using Modbus RTU. When the downstream device responds, the gateway meter forwards the response back to the Modbus master. In addition to Modbus slave addresses 1 to 247, the Modbus gateway supports slave address 255, which sends a Modbus request to the gateway meter only.

For Modbus gateway, you must install the serial Modbus slave devices, configure them and connect them to your Ethernet-connected Modbus gateway meter. Ensure that each serial device is configured to communicate over Modbus with the same baud rate and has a unique unit ID. Configure the gateway meter's serial port to use the Modbus master protocol and enable the Modbus gateway feature, create a Modbus gateway site in ION Setup or an energy management system, and add the serial devices to the Modbus gateway site.

NOTE: Modbus Ethernet gateway supports up to 32 Modbus TCP connections.

Configuring a Modbus gateway using ION Setup

You can configure Modbus gateway on your meter using ION Setup.

Before you begin, make sure you have completed the following tasks:

- Confirm the serial network of devices are wired and configured to have the same baud rate, serial port settings (for example, 8N1), and protocol (Modbus).
- Confirm each serial device has a unique unit identifier.
- Confirm the serial network of devices are connected to the gateway meter's serial communication port.
- Confirm your gateway meter is communicating over Ethernet.
- Confirm that the Modbus RTU and Modbus TCP/IP Ethernet protocols are enabled on your gateway meter.

To configure a Modbus gateway using ION Setup:

1. Start ION Setup.
2. Open the **Setup Assistant** for your meter.
3. Click **Communications** > **Serial settings** and select the tab for the communications port that the serial network is connected to.
4. Select **Protocol** and click **Edit**.
The protocol selection screen appears.
5. Set the protocol to **Modbus Master**.
6. Click **Communications** > **Basic Ethernet** > **TCP/IP**.
7. Select **Modbus Gateway** and click **Edit**.
The Modbus gateway selection screen is displayed.
8. Select the communications port that the serial network is connected to (and you just set to use the Modbus master protocol) and click **OK**. The Modbus gateway connection is created.
9. Create an Ethernet gateway site to access the serial network of devices through your gateway meter.

Creating an Ethernet gateway site using ION Setup

You can create an EtherGate or Modbus gateway site in ION Setup to view serial devices connected to your meter when it is functioning as an Ethernet gateway.

You must have Ethernet gateway communications configured and your gateway and serial devices connected and communicating.

1. Start ION Setup.
2. Right-click on your workstation icon and select **Insert Item**.

The **New Network Item** dialog appears.

3. Select **Site** and click **OK**.

The **New Site** dialog appears.

4. Select the **General** tab and configure the site.

Parameter	Values/Options	Description
Name	-	Ethernet gateway site name
Comm Link	Ethernet	Ethernet communications
Ethernet options	Gateway	Ethernet gateway communications
Gateway Info: IP Addr	-	IP address of the Ethernet gateway meter
Gateway Info: Port	7801, 502	- 7801 for EtherGate (Com1) - 502 for Modbus gateway

5. Click **OK** to create the site.
6. Right-click on your newly created site and select **Insert Item**.
The **New Network Item** dialog appears.
7. Ensure the new Ethernet gateway site is selected in the **Attach to** drop-down list box.
8. Select **Device** and click **OK**.
The **New Device** dialog appears.
9. Enter the details of your serial device. Click **OK** to add the serial device to your Ethernet gateway site.
10. Repeat for all the serial devices on the gateway meter.

NOTE: Use a separate standard Ethernet connection in ION Setup to connect to and read data from your Ethernet gateway meter.

HTTPS

HTTPS (Hypertext Transfer Protocol Secure) is an extension of HTTP and is used by a web browser to establish communication between a client computer and the meter's web server hosting webpages.

HTTPS uses Transport Layer Security (TLS) encryption to secure the communications channel and protect exchanged data between the client and the server. When configured to use HTTPS, the meter uses the self-signed certificate installed on its web server.

You can view the meter's webpages by entering the meter's IP address on a web browser.

The meter uses port 443 for HTTPS by default.

Changing web protocol settings using ION Setup

Web protocol settings	Description
HTTPS With HTTP Redirect	Redirects all HTTP requests to use HTTPS.
HTTPS	Allows only secure access and encrypted communications between the client computer and the meter's internal web server hosting webpages.
Disabled	Turns off the meter's web functionality and blocks all access to the meter's web server.

To change web protocol settings using ION Setup:

1. Open ION Setup and select the **Setup Assistant** for your meter.
2. Click **Communications > Advanced Ethernet > Protocols tab**.
3. Select the **Web** protocol and click **Edit**.
4. Select a web protocol setting.
5. Change the default Assigned Port Numbers for **HTTPS With HTTP Redirect** and **HTTPS**. This requires appending the changed port number for HTTPS access to the meter's webpages, for example: <meter IP address>:<changed https port number>.

Secure website indicator

A secure website displays a visible indicator such as a lock icon on the web browser.

The web address prefix https:// also indicates that the website is secure.

Web browsers typically prompt or display a message to warn you if a website you are trying to access is not secure. For https connections, this indicates that the website's SSL certificate is not configured properly or is missing.

Default SSL certificate and webpages security

The meter web server protocol is factory-set to HTTPS with HTTP Redirect.

The meter ships from the factory with a self-signed certificate installed and is set to use HTTPS protocol when accessing the webpages. Because the SSL certificate is self-signed and not signed by a trusted Certificate Authority (CA), almost all browsers will flag the webpages as unsafe.

- If your meter is accessible only inside a secure network, you can add a security exception to override how the browser identifies the webpages.
- If your meter is outside a secure network, you can install an SSL certificate issued by a CA.

Uploading a custom SSL certificate

You can upload a custom SSL certificate through the meter webpages.

Your meter supports .pem certificate file formats.

To upload a custom SSL certificate:

1. Use a web browser to log in to your meter.
2. Navigate to **Setup > HTTPS**.
3. Click **Upload certificate**.
4. Browse to the custom certificate, select it, then click **Open**.

The certificate is uploaded to the meter and the browser session is restarted.

Generating a new self-signed SSL certificate

A self-signed certificate is valid during the lease period. Generating a new certificate renews the lease.

To generate a new self-signed SSL certificate using the meter webpages:

1. Use a web browser to log in to your meter.
2. Navigate to **Setup > HTTPS**.
3. Click **Generate new self-signed certificate**.

The meter prompts that the custom certificate will be deleted and that you will be logged out.

4. Click **OK** to proceed.

Deleting a custom SSL certificate

1. Use a web browser to log in to your meter.
2. Navigate to **Setup > HTTPS**.
3. Click **Delete custom certificate**.

The meter prompts that you will be logged out and that a self-signed certificate will be used.

4. Click **OK** to proceed.

Secure File Transfer Protocol (SFTP)

Your meter has an internal SSH (Secure Shell) server that can be accessed using an encrypted connection with SFTP (Secure File Transfer Protocol) client software. The SSH server hosts an internal SFTP site and stores files in the meter's flash memory, such as webpages, COMTRADE records and firmware files.

Transferring files using SFTP

Prerequisites:

- Your meter's IP address.
- SFTP port number.
- SFTP client software, such as FileZilla or WinSCP.

To transfer files using SFTP:

1. Start the SFTP client software.
2. Navigate to the desired folder > select file(s) for upload.
3. Close the SFTP client software to disconnect from the meter.

Free up flash memory

Error messages related to available site space for storing files can be resolved by deleting files using an SFTP client application. Available site space is affected by the number and size of stored files and by features that use flash memory, such as increasing the number of COMTRADE waveform records.

SFTP folders and file permissions

SFTP folder structure:

Folder	Description
COMTRADE_1 to COMTRADE_3	View COMTRADE files from these folders. Users have read permission of files.
documents	Add any file type to this folder. Users have full control of files.
IEC61850	Add an IEC 61850 configuration (CID) file to this folder to activate IEC 61850 functionality. Users have full control of files in the root and read permission of files in the log folder.
optionModuleUpg and rmUpg	Upload firmware upgrade files for your meter's display or option modules to these folders. Users have full control of files.
web	Add custom webpages to the meter by transferring them into web subfolders. This folder is where default meter webpages are stored. Users have full control of files.

SFTP filename requirements

Files uploaded to flash memory using SFTP cannot include: spaces, “,” \, /, *, ?, <, >. Maximum filename length is 68 characters, including the file extension.

Simple Network Management Protocol (SNMP)

Your meter supports Simple Network Management Protocol (SNMP) after you have enabled SNMP on your meter. You need to upload the meter's Management Information Base (MIB) file (available from www.se.com) into the Network Management System (NMS) managing your meter.

SNMP is part of the Transmission Control Protocol/Internet Protocol (TCP/IP) protocol suite. SNMP is an application layer protocol that enables the exchange of network management information between devices, allowing you to manage network performance and to identify and solve problems on networks with devices of various types.

SNMP configuration assumes that you have an advanced understanding of SNMP and the communications network and power system that your meter is connected to.

Key terms

Term	Definition
Agent	Software resident on the managed device which interfaces between the device and the NMS.
Managed device	Your meter in the SNMP network.
Community name/string	A text string that helps authenticate requests between the managed device and the NMS.
Managed object	Any parameter referenced in the MIB file.
MIB	A management information base which organizes the OIDs in a hierarchical tree.
NMS	A network management station, manager or client that executes applications to monitor and control devices. An NMS must have the standard and custom MIB files and SNMP manager software.
OID	An object identifier that uniquely identifies and labels a managed object in the MIB.
Trap receiver	An NMS that is configured to receive traps and whose IP address is an SNMP trap destination.

Your meter in an SNMP system

Your meter is a managed device with an SNMP agent in an SNMP network.

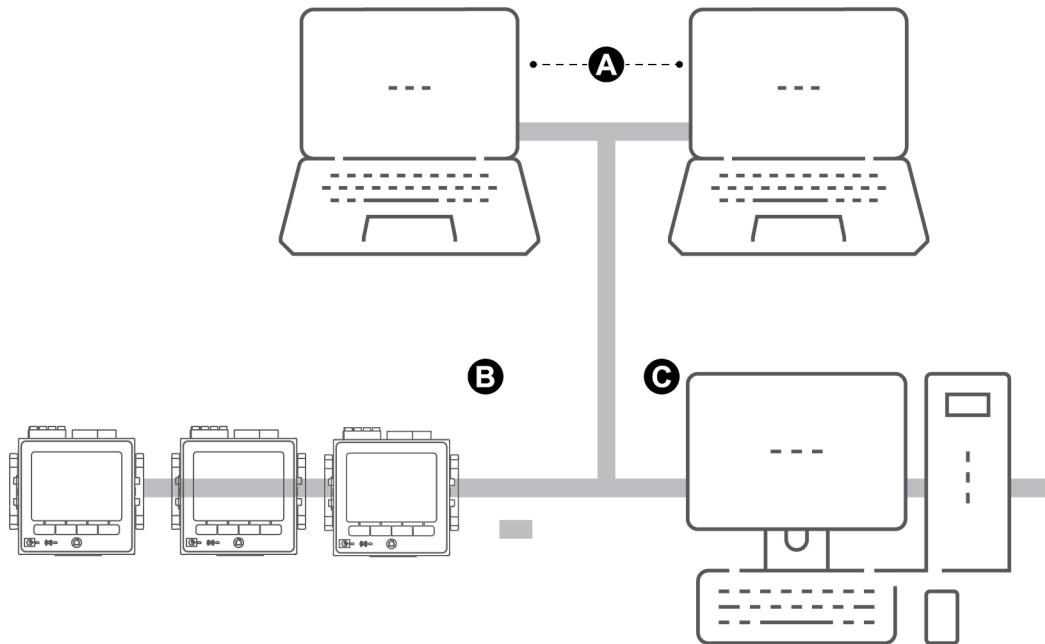

A Trap receivers

B	SNMP agent (meter)
C	NMS with SNMP manager software and MIB file installed

NOTE: The NMS computer can also function as a trap receiver.

SNMP trapping

SNMP trapping allows your meter's agent to notify the NMS of events with an unsolicited SNMP message (a "trap" of the meter's alarm event).

You can enter up to four IP addresses for SNMP trap notification for generic and enterprise-specific traps. For enterprise traps, you must also define the number of events or maximum time delay before SNMP traps are sent to the NMS.

SNMP trapping is only supported on SNMP v2.

Configuring SNMP using ION Setup

You can enable SNMP and configure SNMP trapping using ION Setup.

Download the ION MIB file from www.se.com.

To configure SNMP using ION Setup:

1. Start ION Setup.
2. Open the **Setup Assistant** for your meter.
3. Click **Communications > Advanced Ethernet > SNMP**.
4. Configure your meter's SNMP parameters by selecting the parameter and clicking **Edit**. Click **OK** in the editing screen to set the parameter value.

Parameter	Description
Enable SNMP	Enables or disables SNMP on your meter.
Enable Traps	Enables or disables SNMP trapping on your meter.
Trap Rcvr1 Addr to Trap Rcvr4 Addr	Enter up to four trap receiver IP addresses where trap messages will be sent.
Read only community	Enter the community string used for SNMP get (read-only) requests.
Read write community	Enter the community string used for SNMP set (read/write) requests. Note: You can use the read/write community string for SNMP get (read-only) requests.
System contact	Enter the name of your SNMP system administrator.
System name	Enter a descriptive name for your meter.
System location	Enter your meter's location.

5. Review the rest of the SNMP information and modify if necessary.

Configuring SNMP using webpages

You can configure SNMP trapping using your meter's webpages.

Download the ION MIB file from www.se.com.

1. Connect to your meter's webpages.
2. Go to **Setup > SNMP Parameters**.

- Configure your meter's SNMP parameters by selecting the parameter value.

Parameter	Range	Description
Enable SNMP	Yes/no	Enables or disables SNMP on your meter.
SNMP Port Number	161 (default)	Enter your meter's SNMP port number.
System contact	-	Enter the name of your SNMP system administrator.
System name	-	Enter a descriptive name for your meter.
System location	-	Enter your meter's location.
Read-only Community Name	-	Enter the community string used for SNMP get (read-only) requests.
Read-write Community Name	-	Enter the community string used for SNMP set (read/write) requests. NOTE: You can use the read/write community string for SNMP get (read-only) requests.
Enable SNMP Traps	Enable/disable	Enables or disables SNMP trapping on your meter.
Enable High Priority Alarms	Yes/no	Enables trapping of events that create high priority alarms.
Enable Med Priority Alarms	Yes/no	Enables trapping of events that create medium priority alarms.
Enable Low Priority Alarms	Yes/no	Enables trapping of events that create low priority alarms.
Report Buffer Size	1–30	Enter the maximum number of trap messages to be stored before the trap messages are sent. Traps are sent when the number of trap messages is equal to or greater than this value.
Report Hold Time	1–300 seconds	Enter the maximum duration for trap messages to be held. Trap messages are sent when the time after a trap event has occurred is equal to or greater than this value.
Trap Rcvr1 Addr to Trap Rcvr4 Addr	-	Enter up to four trap receiver IP addresses, where trap messages will be sent.

- Click **Apply** to configure the meter's SNMP parameters.

SNMP implementation

MIB files

Your meter is compliant with MIB-II as defined by the standard MIB file RFC 1213.

SNMP requires that you load your meter's ION MIB file (available for download from www.se.com) into the NMS.

You must install RFC 1213, which is required to read basic network information for the meter (for example, TCP/IP traffic or number of packets received), if it is not included with your SNMP manager software.

Community strings

A community string is a text string which acts to help authenticate requests from the NMS to your meter.

There are two community strings on your meter:

- Read Only Community: this community string is used by SNMP get (read-only) requests. The read only community string's initial factory-set value is **public**.
- Read Write Community: this community string is used by SNMP set (read/write) requests. The read write community string's initial factory-set value is **private**.

NOTE: You can also use the read write community string for SNMP get (read-only) requests.

If your meter receives an incorrect community string, it generates an AuthenticationFailure trap.

System strings

A system string is a text string which can be configured to provide information about your meter.

There are three system strings on your meter:

- System contact: Enter the name of the SNMP system administrator.
- System name: Enter a descriptive name for your meter.
- System location: Enter a description of your meter's location.

SNMP trapping implementation

Generic SNMP traps supported by your meter are:

- Coldstart: The meter (SNMP agent) is starting.
- Linkup: The SNMP agent is enabled.
- AuthenticationFailure: The meter (SNMP agent) has received an incorrect community value.

Enterprise-specific SNMP traps supported by your meter are:

- Low: Trap of events with a low event priority.
- Medium: Trap of events with a medium event priority.
- High: Trap of events with a high event priority.

Trap	Event priority range
Low	64–127
Medium	128–191
High	192–255

NOTE: The number of events or maximum time delay settings only apply to enterprise SNMP traps.

See *ION Reference*, available from www.se.com, for detailed information on the SNMP Mapping, SNMP Options and Alarm Options modules.

Default SNMP mapping

Enabling SNMP provides SNMP access to the meter values linked to the SNMP Mapping module.

You can configure the SNMP Mapping module to link to different meter values. By default, the following meter values are linked to the SNMP Mapping module:

I a	kVAR tot	VII ca	VIn avg	Ib mean	kW sd mx del-rec
I b	kVA tot	VII avg	Freq	Ic mx	kW sd del
I c	PF sign tot	VIn a	Ia mx	Ic mean	kW sd rec
I avg	VII ab	VIn b	Ia mean	kW sd mx del	kW sd del-rec
kW tot	VII bc	VIn c	Ib mx	kW sd mx rec	kVAR sd mx del
kVAR sd mx rec	kVAR sd mx del-rec	kVAR sd del	kVAR sd rec	kVAR sd del-rec	kVA sd mx del
kVA sd mx rec	kVA sd mx del-rec	kVA sd del	kVA sd rec	kVA sd del-rec	kWh del
kWh rec	kWh del-rec	kVARh del	kVARh rec	kVARh del-rec	kVAh del
kVAh rec	kVAh del-rec				

The following meter information is always provided by default and cannot be configured:

Volts mode	Model number
Serial number	Device name
Firmware version	MIB version

If you change your meter's default values, you must modify the custom MIB file to reflect the new values.

Changing your meter's default SNMP configuration assumes that you have an advanced understanding of ION architecture, SNMP, and the communications network and power system that your meter is connected to.

See *ION Reference*, available from www.se.com, for detailed information on the SNMP Mapping module.

Configuring SNMP MIB files

You must configure your MIB file if you modify the default SNMP information provided by the meter for the MIB file labels to reflect the modified values.

Download the ION MIB file from www.se.com.

NOTE: You should only configure the variable name and description. Changing other fields in your MIB file may cause the client software to report problems or return errors when trying to retrieve or view parameters.

The variable name must conform to the following rules:

- The first character must be a letter.
- The first character must be lower case.
- The name must not contain any special characters such as *, ?, &.
- The name must not contain spaces.

To configure your SNMP MIB file:

1. Open your meter’s MIB file in a text editing program (such as Notepad).
2. Update the variable name and description so they match the meter values connected to the SNMP Mapping module.
3. Save your meter’s MIB file. Keep the original file extension of .MIB.

Example:

This example shows an original and an updated OID entry in an MIB file, where the default meter value of voltage line-to-neutral phase A is modified in the meter’s SNMP Mapping module and is now connected to voltage line-to-neutral phase C.

```
Original OID entry
Vln_a OBJECT-TYPE
SYNTAX DisplayString (SIZE (0..255))
ACCESS read-only
STATUS mandatory
DESCRIPTION "Host Meter Voltage Line A to Neutral Units = V (Volts)" ::= { Schneider Electric
34 }
```

You must update the variable name and description to match the meter values connected to the SNMP Mapping module:

Value	Original	Updated
Variable name	Vln_a	Vln_c
Description	"Host Meter Voltage Line A to Neutral Units = V (Volts)" ::= { Schneider Electric 34 }	Host Meter Voltage Line C to Neutral Units = V (Volts)" ::= { Schneider Electric 34 }

The SNMP client software reads the original and updated file as follows:

Original	Updated
variable name: VIn_a	variable name: VIn_c
Description: "SNM1 Input 1 - Voltage (line-to-neutral) phase A"	Description: "SNM1 Input 1 - Voltage (line-to-neutral) phase C"

IEC 61850

IEC 61850 is an Ethernet-based communications protocol designed for electrical substations.

Your meter can be integrated into an IEC 61850 system as an Intelligent Electronic Device (IED) or server that supports concurrent IEC 61850 client connections and an SFTP connection.

Go to the IEC International Electrotechnical Commission website at www.iec.ch for more information on the IEC 61850 protocol.

Refer to the *IEC 61850 and ION technology* protocol document at www.se.com for information about setup and configuration.

Mapping additional data to IEC 61850

Map additional data, such as Inputs and Outputs, to IEC 61850. You do not need to have IEC 61850 enabled on your meter to perform this procedure.

To map additional data to IEC 61850:

1. Open ION Setup > select the meter > **Setup Assistant**.
2. **Communications > 3rd Party Protocols > IEC 61850**.
3. Highlight a parameter to add to IEC 61850 data. Select analog for numeric information and digital for Boolean or binary information.
4. Click **Edit**. The custom configuration screen is displayed.
5. Select the desired meter value. If the value you want is not shown, select **Show all available registers**.
6. Select an IEC 61850 item:
 - Click >> to map the value.
 - Click << to unmap values.
7. Click **OK**.

Enabling IEC 61850 functionality

Your meter is configured with a default set of data available to IEC 61850 that can be integrated into a IEC 61850 system. To enable this functionality, upload a CID (Configured IED Description) file to your meter.

If more than one CID file is stored in the meter, IEC 61850 functionality is deactivated until additional files are deleted.

Prerequisites:

- *CET850 IEC 61850 configuration tool* installed on your computer. Download the software at www.se.com.
- Meter connection using ION Setup over IPv4 Ethernet.
- Download the firmware package for your meter and select an ICD (IED Capability Description) file that matches your meter's profile. Go to www.se.com and search for firmware and associated files (ZIP) for your meter.

Enabling IEC 61850 functionality consists of 2 steps:

1. Build the CID file using the *CET850 IEC 61850 configuration tool*.
2. Upload the CID file using ION Setup.

Step 1 – Build the CID file:

1. Open the *CET850 IEC 61850 configuration tool*.
2. **File > New**.
3. **Add > IED**. The Add IED dialog box opens.
4. Click more options ... in the IED identification area. The Add a Device dialog box opens.
5. Select **Other device**.
6. Click more options
7. Browse to the location of the ICD file, select it and click **Open**.
8. Click **OK**.
9. Enter values for the device in the IED dialog box and click **OK**.
10. **File > Build a CID file**.
11. Click **Yes** on the CET850 message box.
12. Save the file as an SCD file. The Save as dialog box opens.
13. Ensure **CID files (*.cid)** is selected and click **Save**.
14. Close the *CET850 IEC 61850 configuration tool*.

Step 2 – Upload the CID file:

1. Open ION Setup > select the meter > **Setup Assistant**.

NOTE: The CID file can also be uploaded using SFTP. Refer to "SFTP folders and file permissions" on page 106 for more information.

2. **Communications folder > 3rd Party Protocols > IEC 61850 > Upload CID**.
3. Navigate to the CID file, select it and click **Open**. CID file validation can take several minutes.

The CID status on the IEC 61850 tab indicates if the meter is operating as an IEC 61850 IED or server.

Watch the video on [How to Enable IEC 61850 Functionality on Your Meter](#).

Configuring digital outputs for IEC 61850 control

Configure default settings for digital outputs to use IEC 61850 for non-critical control of the meter's digital outputs.

This procedure is optional. Your meter has a comprehensive default settings for IEC 61850 that meet the needs of most systems without configuration. This is an advanced procedure that requires in-depth knowledge of your meter, its underlying architecture, and the system in which it is installed.

WARNING

UNINTENDED OPERATION

Do not use this device for critical control or protection of persons, animals, property, or equipment.

Failure to follow these instructions can result in death, serious injury, or equipment damage.

To configure digital outputs for IEC 61850 control:

1. Open ION Setup.
2. Ctrl + click on the meter to select it. This switches ION Setup to Advanced mode.
3. **IEC 61850 GGIO Onb Modules** folder > double-click module > **Setup Registers**.
4. Select the desired **SPCS Control Mode** register > **Edit**. A dialog opens.
5. Select IEC 61850 CtlVAL from the drop-down list box > **OK** > **Inputs**.
6. Select the digital output Status register > **Delete**.
Note: This digital input register must be deleted to prevent a circular reference that will cause the affected modules to go offline.
7. Click **Send**.
8. Navigate to the **Digital Out Modules** folder > double-click on the module selected to control via IEC 61850.
9. Select the Setup Registers tab and confirm that the Digital Output module's setup registers are configured.
10. **Inputs** > *Source* register > **Edit**.
11. Navigate to the IEC 61850 GGIO Onb folder and select the *SPCS.stVal* output register that corresponds to the digital output.
12. Click **OK** > **Send**.

See *ION Reference*, available from www.se.com, for information about IEC 61850 GGIO and Digital output modules.

Deleting an IEC 61850 configuration file

1. Open SFTP client software. See "Secure File Transfer Protocol (SFTP)" on page 105 for information about connecting with SFTP client software.
2. Connect to the meter using the meter's IP address and SFTP port number. See "Protocols, ports, and connections" on page 65 for information on port numbers.
3. Open the **IEC61850** folder in SFTP file directory and delete the CID file.
4. Close SFTP client software.

Distributed Network Protocol (DNP)

The Distributed Network Protocol Version 3.0 (DNP 3.0) is an open protocol used in the electric utility industry for communications and interoperability among substation computers, Remote Terminal Units (RTUs), Intelligent Electronic Devices (IEDs, for example: meters), and master stations.

Your meter can be integrated into a DNP network as a DNP slave.

DNP supported features and default implementation

Your meter is pre-configured for basic DNP Slave functionality.

Your meter supports a maximum of three concurrent connections (sessions) using the DNP 3.0 protocol; one for each serial port, up to three using Ethernet, or a combination of both.

Combinations available depend on the meter's communications options. A session consists of all incoming and outgoing DNP Master/Slave traffic on one of the meter's communications ports.

For serial DNP communications, you must assign the DNP protocol to the appropriate serial communication port on your meter; you do not have to configure your meter's Ethernet port(s).

You can modify your meter's default DNP map using configuration software.

Data can be imported into the meter from a DNP control relay or analog output device. This is an advanced feature intended for users with an in-depth understanding of the DNP 3.0 and ION protocols.

See the online ION Setup help for instructions on connecting to your meter and accessing the Setup Assistant, which can be used to modify your meter's DNP port settings and default DNP map.

Go to www.se.com to download your meter's DNP 3.0 device profile document for detailed information on your meter's default DNP map and implementation.

See the *Multipoint DNP 3.0 and ION Technology* technical note, available from www.se.com, for details.

Inputs/Outputs

Inputs/Outputs overview

Your meter has onboard digital Input/Output (I/O) which can be increased by adding optional digital and analog I/O modules to expand your meter's I/O capabilities.

WARNING

UNINTENDED OPERATION

Do not use this device for critical control or protection of persons, animals, property, or equipment.

Failure to follow these instructions can result in death, serious injury, or equipment damage.

Your meter base has:

- three digital inputs
- one form A digital output
- 2 energy pulsing LEDs (one visible, one infrared)

You can view information about your meter's I/O through the display and webpages, and configure your meter's I/O using ION Setup.

NOTE: The digital outputs can handle voltages less than their specified maximum. For higher voltage applications, use an external relay in the switching circuit.

Input/output ION modules

ION modules are used to configure your meter's digital or analog inputs/outputs (I/O).

You need to configure the following ION modules to use the meter's digital or analog I/O.

- Digital input: uses the Digital Input module, which tells the meter how to interpret incoming signals.
- Digital output: uses one of three ION modules depending on the application.
 - Digital Output module: Monitors a change of state to control relay operation via a hardware output device.
 - Pulser module: Transfers high-speed pulses to a hardware pulse counting device that is used to track energy usage.
 - Calibration Pulser module: Integrates instantaneous power inputs, then outputs high-speed pulses to an LED that can be monitored for energy accuracy verification.
- Analog input: uses the Analog Input module, which tells the meter how to interpret an incoming analog voltage or current signal from transducers.

- Analog output: uses the Analog Output module to deliver a continuous direct voltage or current analog signal to transducers.

NOTE: All of these modules can act as intermediaries between the physical hardware port and the other modules in the meter. They define the characteristics of the incoming and outgoing signals.

Input/output ION modules, ports, and labels

You can configure the Digital Output, Digital Input, Analog Input, Analog Output, Pulser and Calibration Pulser ION modules to specify which port handles the outgoing or incoming signals.

To assign a port to one of these modules, modify the *Port* setup register by picking a port from the enumerated list.

NOTE: If the port you want to use does not appear in the *Port* setup register list, that port is in use by another module. Edit the *Port* setup register of the module using that port and set it to **Not Used**. The port is then available to other modules.

Factory configured settings

Onboard input and output ports

ION module type	ION module name	Hardware port (device label)	Port name (ION label)	Description
Digital Output	Port D1	D1	Port D1	Form A output
Calibration Pulser	MU WhPulser LED	N/A	Top LED	Watt energy pulsing (located on meter body)
Digital Input	Port S1	S1	Port S1	Externally excited
Digital Input	Port S2	S2	Port S2	Externally excited
Digital Input	Port S3	S3	Port S3	Externally excited

Option module(s) input and output ports

ION module type	ION module name	Hardware port (device label)	Port setup register name	Description
Digital Input	Port A/B/C/D S1–S6	S1–S6	Port A S1–S6 Port B S1–S6 Port C S1–S6 Port D S1–S6	Option module digital inputs
Digital Output	Port A/B/C/D D1–D2	Relay 1–Relay 2	Port A D1–D2 Port B D1–D2 Port C D1–D2 Port D D1–D2	Option module digital output
Analog Input	Port A/B/C/D A1–A4	A1–A4	Port A A1–A4 Port B A1–A4 Port C A1–A4 Port D A1–A4	Option module analog input
Analog Output	Port A/B/C/D Q1–Q2	Q1–Q2	Port A Q1–Q2 Port B Q1–Q2 Port C Q1–Q2 Port D Q1–Q2	Option module analog output

NOTE: When configuring your meter, the configuration interface may show all the possible ports, regardless of what is physically available on your meter.

See *ION Reference*, available from www.se.com, for more information about ION modules.

I/O option modules

I/O option modules provide increased digital and analog input/output (I/O) capabilities for your meter.

These I/O modules can be used to monitor the status of breakers, control analog or digital transducers, or receive signals that can be interpreted to provide WAGES data for your energy system. For applications requiring high accuracy, such as energy pulsing to verify accuracy, the digital output on the meter base is recommended.

NOTE: Your meter's digital and analog outputs may change state during a firmware upgrade. Option modules are offline during an option module firmware upgrade; they will not communicate to the meter and the outputs may change state during the upgrade process.

Your meter's analog I/O option modules can measure and output either low voltage or current using standard analog transducers such as 4–20 mA current transducers.

Viewing I/O option module data

View I/O option module data using ION Setup, meter webpages, or the display.

To view option module data using ION Setup:

1. Start ION Setup.
2. Open the Setup Assistant for your meter.
3. Select **Expansion Modules > Option I/O Modules**, and then select the desired I/O option module tab.
4. If there are no I/O option modules connected, no information other than column headers is displayed.

To view option module data using meter webpages:

1. Connect to your meter webpages.
2. Go to **Monitoring > Inputs/Outputs**, and then select **Digital Inputs**, **Digital Outputs**, **Analog Inputs** or **Analog Outputs**.
3. If there are no I/O option modules of the specified type, no entries other than column headers are displayed.

To view option module data using the display:

Go to **Inputs/Outputs**, and then select **Digital Inputs**, **Digital Outputs**, **Analog Inputs** or **Analog Outputs**.

I/O option module configuration

You can configure your meter's I/O option modules using ION Setup.

The Option I/O Modules screen has tabs corresponding to the possible option modules, which are identified based on how the option modules are connected to the meter. Each tab indicates the module's type and status and has an area where the module's ports are listed for viewing and configuration. You can also reset your meter's option modules using ION Setup.

Status examples	Description
None	No option module detected
Normal	The option module is operating normally
Option module added	A new option module is detected
Option module removed	The option module has been removed
Invalid S19	The option module's firmware is not supported
Invalid card	The option module type is not supported

Analog inputs

Analog input applications

You can use an analog input to monitor an analog signal, for example a flowmeter, to monitor how much water flows through a pipe.

For analog input operation, your meter takes an analog input signal and provides the resulting scaled value.

Your meter's analog I/O option modules can measure either low voltage or current using standard analog transducers such as 4–20 mA current transducers.

Analog input voltage and current mode

You can set the analog input's mode for voltage or current sensing.

In current mode, the analog inputs have a low input resistance while the meter is powered on, and a high input resistance when the meter is powered off. In voltage mode, the analog inputs have a high input resistance regardless of whether the meter is powered or not.

NOTE: When unpowered, your meter's analog inputs act like they are in voltage mode (high input resistance).

When connected to a current output transducer, this high resistance can create a high voltage. Standard (i.e., 4–20 mA) current transducers have open circuit protection and can handle a high input resistance; however, if non-standard transducers are used high voltages may be generated. Your meter's analog input has circuitry to limit this voltage, but it may not be sufficient with a very high-power current source.

NOTICE

EQUIPMENT DAMAGE

- Ensure the analog input is configured for the correct voltage or current mode before connecting or activating the current transducer.
- Do not exceed the device's ratings for maximum limits.

Failure to follow these instructions will result in equipment damage.

Analog input behavior

Analog inputs may show a value below zero scale if an open circuit is detected on the input port.

Analog input zero scale and full scale values

In most cases the output range of the sensor feeding the analog input matches the hardware limits of your meter's analog input port. In that case, the analog input's zero scale and full scale values are the same as the sensor's represented range. For example:

Analog sensor	Meter's analog input signal	Analog input register values
0–50 psi represented by a 4–20 mA signal	4–20 mA analog input range Input value: 12 mA	Full scale = 50 (psi) Zero scale = 0 (psi) Scaled value: 25 (psi)
0–50 psi represented by a 0–20 mA signal	0–20 mA analog input range ¹ Input value: 12 mA	Full scale = 50 (psi) Zero scale = 0 (psi) Scaled value: 30 (psi)

If the sensor's output range does not match your meter's hardware limits, you must calculate the full scale and/or zero scale values by analyzing the system.

See *ION Reference*, available from www.se.com, for detailed information about the Analog Input mod

Configuring option module analog inputs using ION Setup

You can configure analog inputs using ION Setup.

Analog inputs are available on the optional I/O modules.

Calculate your zero scale and full scale values based on the analog source and the input range of your meter.

Make sure that the analog input port that you want to use is properly configured and connected to a valid external analog signal source.

1. Start ION Setup.
2. Open the **Setup Assistant** for your meter.
3. Click **Expansion Modules > Option I/O Modules** and select the module tab that corresponds to the option module with the analog input you want to configure.
4. Select the analog input channel and click **Edit**. Enter the meter password if prompted. The setup screen for that analog input is displayed.
5. Configure the analog input by selecting the parameter and clicking **Edit**.

Parameter	Value/Range	Description
Zero scale	0 to $\pm 10^9$	The minimum source value that matches the minimum analog input signal.
Full scale	0 to $\pm 10^9$	The maximum source value that matches the maximum analog input signal.
Port	-	The physical analog input port connection.
Mode	Voltage, current	Determines whether the analog input is monitoring voltage or current.
Update Rate	One Second/High Speed	Defines how frequently the input is updated.

¹Analog I/O option module must have firmware version v1.2 or later.

Analog outputs

Analog output applications

You can use an analog output to send a signal to an external analog input, for example an analog-controlled valve, to modify a water pipe's valve position to change the flow rate.

For analog output operation, your meter takes an input value and scales it to the appropriate signal value to send out the physical analog output port.

Your meter's analog I/O option modules can output either low voltage or current using standard analog transducers such as 4–20 mA current transducers.

Analog output behavior

Your meter's analog output, after it is configured, outputs voltage or current signals. If your meter's analog output source becomes unavailable (N/A) the analog output level should go to zero (0 V/0 mA) under most conditions.

When your meter is powered off or configured to send voltage, the meter registers as a high impedance.

The electrical signal on the analog output is DC; make sure proper polarity is observed when wiring external devices to the analog output ports.

Analog output zero scale and full scale values

In most cases, your meter's analog output range matches the range of the analog sensors that your meter's outputs are connected to. In that case, your meter's analog output zero scale and full scale values are the maximum and minimum values of the source driving your meter's analog output. These values are used to normalize the source value to a value between 0 and 1 which is applied to the operating range of the analog output port to determine the analog output current or voltage. For example:

Source value	Analog output register values	Meter's analog output signal
0–120 kW range	Full scale = 120 (kW)	4–20 mA range
100 kW	Zero scale = 0 (kW)	Output: 17.33 mA
	Normalized: 0.83	
0–120 kW range	Full scale = 120 (kW)	0–20 mA range ¹
100 kW	Zero scale = 0 (kW)	Output: 16.67 mA
	Normalized: 0.83	

If your meter's analog output range does not match the range of the connected analog sensor, you must calculate the full scale and zero scale values by analyzing the system.

See *ION Reference*, available from www.se.com, for detailed information about the Analog Output mod

¹Analog I/O option module must have firmware version v1.2 or later.

Configuring option module analog outputs using ION Setup

You can configure option module analog outputs using ION Setup.

Analog outputs are available on the optional I/O modules.

Calculate your zero scale and full scale values based on the measured value and the analog output range of your meter.

Make sure that the analog output port that you want to use is properly connected to an analog receiver.

1. Start ION Setup.
2. Open the **Setup Assistant** for your meter.
3. Click **Expansion Modules > Option I/O Modules** and select the module tab that corresponds to the option module with the analog output you want to configure.
4. Select the analog output channel and click **Edit**. Enter the meter password if prompted. The setup screen for that analog output is displayed.
5. Configure the analog output by selecting the parameter and clicking **Edit**.

Parameter	Value/Range	Description
Zero scale	0 to $\pm 10^9$	The minimum source value that matches the minimum analog output signal.
Full scale	0 to $\pm 10^9$	The maximum source value that matches the maximum analog output signal.
Port	-	The physical analog output port connection.
Mode	Voltage, current	Determines whether the analog output is monitoring voltage or current.

Digital inputs

Digital input applications

Digital inputs are typically used for monitoring the status of switches or contacts, such as status contacts on circuit breakers.

They can also be used for pulse counting or input metering applications, such as WAGES (water, air, gas, electricity, steam) monitoring, or conditional energy applications, or IRIG-B time synchronization.

Pulse mode

If you set Input Mode to PULSE, a pulse is generated at the Trigger output when the State output changes from OFF-to-ON. No pulse is generated when State changes from ON-to-OFF.

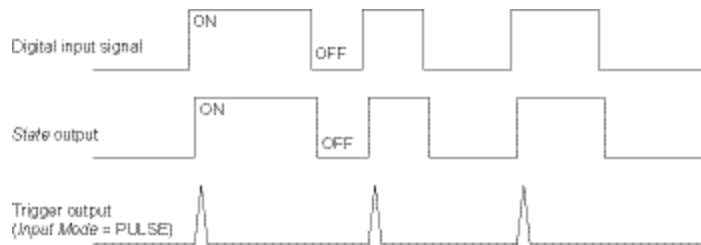

KYZ mode

If you set Input Mode to KYZ, a pulse is generated at the Trigger output for each change of state transition, i.e. from OFF-to-ON and from ON-to-OFF transitions.

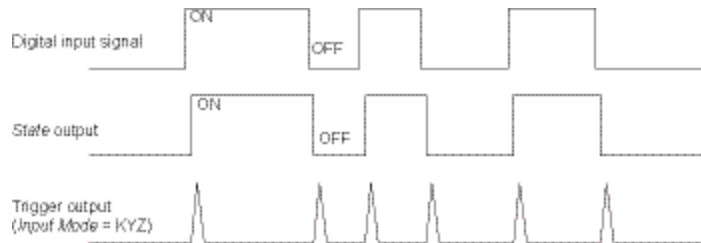

A/C mode

If you set Input Mode to A/C, the digital input port is configured to detect the presence of a low voltage AC signal. The next illustration shows how a digital input can be used to monitor the operation of a low voltage AC fan controller.

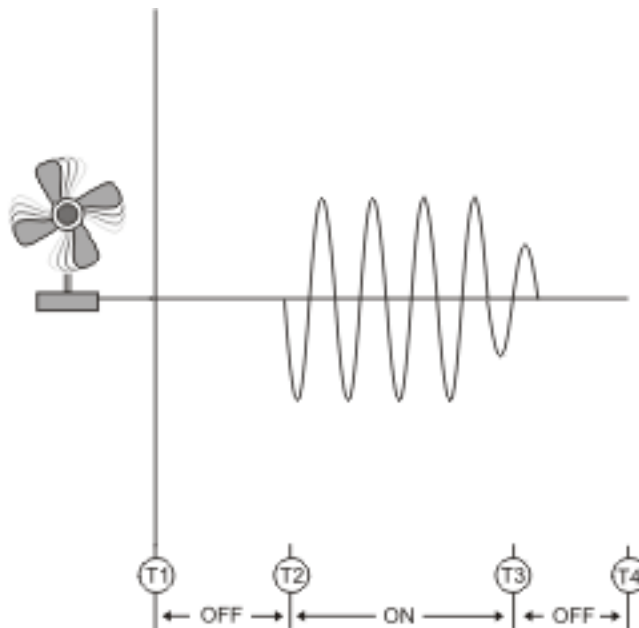

IRIG-B time synchronization

You can use a digital input to synchronize the meter time to an IRIG-B time source.

You can connect an IRIG-B time source to one of meter's digital inputs for IRIG-B time synchronization. For IRIG-B time synchronization, you must configure both the meter's digital input and the meter's clock.

NOTE: For improved accuracy use the digital inputs on the meter base.

Configuring onboard digital inputs using ION Setup

You can use ION Setup to configure your meter's digital inputs.

1. Start ION Setup.
2. Open the **Setup Assistant** for your meter.
3. Click **Onboard I/O > Digital Inputs**. The tabs correspond to each digital input. Click on the tab for the digital input you want to edit.
4. Configure the digital input by selecting the parameter and clicking **Edit**.
5. After the parameter is configured, click **OK** to save the setting to the meter.

Parameter	Value/range	Description
Input Mode	Pulse, KYZ, A/C, IRIG-B*	<p>Specifies how the meter processes the signal:</p> <ul style="list-style-type: none"> • Pulse: the meter counts an entire pulse (from off-on to on-off) as one input. • KYZ: the meter counts a transition (from off-on or from on-off) as one input. • A/C: the meter detects analog signals where the ON condition is based on the presence of an AC signal. • IRIG-B*: the meter detects an IRIG-B time synchronization signal.
Polarity	Inverting/Non-Inverting	Specifies if the signal from the digital port is inverted or not inverted.
Debounce	0.000–1.000	Specifies how long (in seconds) the signal must remain in a state to be considered a valid state change.
Assigned Port	Defined by your meter's hardware	Your meter's physical digital input port.
EventLog Mode	Log Off/Log On	Specifies if events generate log entries.
State	OFF/ON	Indicates the status of the digital input.

* You must also configure your meter's clock to use IRIG-B time synchronization.

Configuring option module digital inputs using ION Setup

You can configure option module digital inputs using ION Setup.

1. Start ION Setup.
2. Open the **Setup Assistant** for your meter.
3. Click **Expansion Modules > Option I/O Modules** and select the module tab that corresponds to the option module with the digital input you want to configure.

4. Select the digital input channel and click **Edit**.
The setup screen for that digital input is displayed.
5. Configure the digital input by selecting the parameter and clicking **Edit**.
6. Once the parameter has been configured, click **OK** to save the setting to the meter.

Parameter	Value/Range	Description
Input Mode	Pulse, KYZ, A/C, IRIG-B*	<p>Specifies how the meter processes the signal:</p> <ul style="list-style-type: none"> • Pulse: the meter counts an entire pulse (from off-on to on-off) as one input. • KYZ: the meter counts a transition (from off-on or from on-off) as one input. • A/C: the meter detects analog signals where the ON condition is based on the presence of an AC signal. • IRIG-B*: the meter detects an IRIG-B time synchronization signal.
EvLog Mode	Log Off/Log On	Specifies if events generate log entries.
Event Priority	0–255	Specifies the priority of an event.
Polarity	Inverting/Non-Inverting	Specifies if the signal from the digital port is inverted or not inverted.
Debounce	0.000–1.000	Specifies how long (in seconds) the signal must remain in a state to be considered a valid state change.
Port	Defined by your meter's hardware	Your meter's physical digital input port.
Enable	Enabled/Disabled	Specifies whether the module is enabled or disabled.
Alarm Trigger Mode	Alarm on ON/Alarm on OFF	Specifies the behavior of the digital input alarm.
* IRIG-B time synchronization is not supported on the option module digital inputs.		

WAGES monitoring

WAGES monitoring lets you record and analyze all energy sources and utilities usage.

Your system may use several different types of energy. For example, you may consume steam or compressed air for industrial processes, electricity for lights and computers, water for cooling and natural gas for heating. WAGES monitoring collects the usage information from all these different energy sources to enable a more complete energy analysis.

WAGES information can help you:

- Identify losses or inefficiencies.
- Modify demand to reduce costs.

- Optimize energy source usage.

WAGES monitoring example

The following example shows WAGES monitoring for a water flow meter.

You can connect your meter's digital input to a transducer that sends a pulse for every 15 kiloliters (4000 US Gal) of water. After configuring an input metering channel and assigning it to the digital input, the meter can detect and record the incoming pulses. An energy management system can then use the information from the meter to perform WAGES analysis.

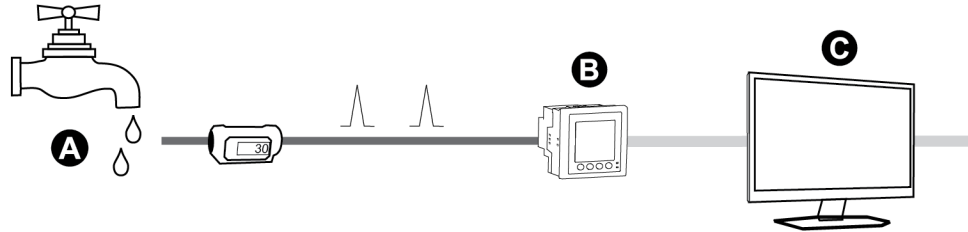

A	Water flow meter (15 kL/pulse)
B	Energy meter with digital input 1 assigned to input metering channel 1 and configured with unit kL (kiloliters)
C	Energy management system with WAGES analysis capabilities

Input metering

Your meter's digital inputs can be used to count pulses from transducers and convert the pulses to energy measurements.

Your meter's input metering channels count pulses received from the digital inputs assigned to that channel. The incoming pulses are used in calculating and measuring consumption data (e.g., BTU, kWh, L, kg). Each channel must have the following values configured to match the pulse data:

- Pulse Weight: the pulses per unit value.
- Unit Code: the unit of measure associated with the monitored value.
- Demand Code: for time-based values (such as kWh), this provides the associated demand units (kW) for demand calculations; for other values (such as kg), this can be configured to provide rate information (kg/h or kg/s).
- Mode: whether a pulse is based on a complete pulse or a transition.

For example, if each complete pulse represents 125 Wh, you can configure for Wh pulsing as follows:

- Pulse Weight = pulses/Wh = 1/125 = 0.008
- Unit Code = Wh
- Demand Code = kW (this is automatically set)
- Mode = pulse

If you want to configure for kWh pulsing, you must adjust the pulse weight calculation and unit code as follows:

- Pulse Weight = pulses/kWh = $1/0.125 = 8$
- Unit Code = kWh

Configuring standard input metering using ION Setup

You can configure input metering with standard units and rates using ION Setup.

When configuring your meter, the configuration interface may show all the possible ports, regardless of what is physically available on your meter.

NOTE: Your device's digital input must be connected to the input metering pulse source. Review the digital inputs assigned to applications to help you understand your existing configuration.

NOTE: To disable an input metering channel and remove any port associations, set Assigned Input to No connection.

1. Start ION Setup.
2. Open the **Setup Assistant** for your meter.
3. Click **Energy Applications > Digital Input Based**.
4. Select the input metering channel you want to configure and click **Edit**. The **Input Metering Channel Setup** screen is displayed.
5. Select **Enabled** to enable the input metering feature.
6. Click **Select** to define which digital input is the pulse source for the input metering channel.
7. Configure the remaining parameters as required.
8. Click **OK** to save your configuration.
9. Configure your meter to log the input metering data if required.

Parameter	Description
Pulse Weight	Enter the value per pulse.
Units	Select the measurement units associated with the pulse.
Demand Period	Enter the frequency in minutes that input metering data is calculated in your energy management system.
Rate	Select the rate associated with the defined Units.
Source ID	Enter a data identifier. This value is added to the input metering channel's output register labels to uniquely identify the data within your energy management system. NOTE: You must select a Unit for this field to appear.

Configuring custom input metering using ION Setup

You can configure input metering with custom units and rates using ION Setup.

When configuring your meter, the configuration interface may show all the possible ports, regardless of what is physically available on your meter.

NOTE: Your device's digital input must be connected to the input metering pulse source. Review the digital inputs assigned to applications to help you understand your existing configuration.

NOTE: To disable an input metering channel and remove any port associations, set **Assigned Input** to **No connection**.

1. Start ION Setup.
2. Open the **Setup Assistant** for your meter.
3. Click **Energy Applications > Digital Input Based**.
4. Select the input metering channel you want to configure and click **Edit**. The **Input Metering Channel Setup** screen is displayed.
5. Select **Enabled** to enable the input metering feature.
6. Click **Select** to define which digital input is the pulse source for the input metering channel.
7. Clear the **Standard quantity** check box. The screen changes to display custom input metering parameters.
8. Configure the remaining parameters as required.
9. Click **OK** to save your configuration.
10. Configure your meter to log the input metering data if required.

Parameter	Description
Pulse Weight	Enter the value per pulse.
Units	Select the measurement units associated with the pulse. Note: Include source identification information by entering "@" followed by the source identifier.
Demand Period	Enter the frequency in minutes that input metering data is calculated in your energy management system.
Rate	Select the rate associated with the defined Units.
Scaling	Select the scaling value based on the relationship between Units and Rate.
Time Base	Select the value and units to match the Rate.

Digital outputs

Digital output applications

Digital outputs are typically used in switching applications, for example, to provide on/off control signals for switching capacitor banks, generators, and other external devices and equipment.

The digital output can also be used in demand synchronization applications, where the meter provides pulse signals to the input of another meter to control its demand period. The digital output can also be used in energy pulsing applications, where a receiving device determines energy usage by counting the kWh pulses coming from the meter's digital output port.

Configuring onboard digital outputs using ION Setup

To configure the meter's digital outputs using ION Setup:

1. Start ION Setup.
2. Open the **Setup Assistant** for your meter.
3. Click **Onboard I/O > Digital Outputs** and select a digital output tab. Configure the digital output by selecting the parameter and clicking **Edit**. Enter the meter password if prompted.

Parameter	Value/range	Description
Source	Digital/Boolean	Link this input to the value that drives the state of the digital output. If Source is not linked, the digital output state is driven by the Force ON, Force OFF values.
Force ON	Pulse	Link this input to a pulse that forces the digital output on for the PulseWidth duration, regardless of the Source input.
Force OFF*	Pulse	Link this input to a pulse that forces the digital output off.
Normal*	Pulse	Pulsing this input will switch the driver of the digital output from Force ON to Source.
Polarity	Inverting/non-inverting	Specifies if the signal to the digital port is inverted or not inverted.
PulseWidth	0–2,000,000	Specifies the duration of the pulse, in seconds. Setting this parameter to 0 sets the digital output continuously on.
Assigned Port	-	The physical digital output port connection. Only available ports are shown.
State	Open/Closed/Not Available	Indicates the status of the digital output.

* These parameters are only valid when pulse width is set to 0.

Configuring option module digital outputs using ION Setup

To configure the option module digital outputs using ION Setup:

1. Start ION Setup.
2. Open the **Setup Assistant** for your meter.
3. Click **Expansion Module > Option I/O Modules** and select the module tab that corresponds to the option module with the digital output you want to configure.
4. Select the digital output channel and click **Edit**. The setup screen for that digital output is

displayed.

- Configure the digital output by selecting the parameter and clicking **Edit**.

Parameter	Value/Range	Description
Source	Digital/Boolean	Link this input to the value that drives the state of the digital output. If Source is not linked, the digital output state is driven by the Force ON, Force OFF values.
Force ON	Pulse	Link this input to a pulse that forces the digital output on for the PulseWidth duration, regardless of the Source input.
Force OFF*	Pulse	Link this input to a pulse that forces the digital output off.
Normal*	Pulse	Pulsing this input will switch the driver of the digital output from Force ON to Source.
EventLog Mode	Log Off/Log On	Specifies if events generate log entries.
Polarity	Inverting/non-inverting	Specifies if the signal to the digital port is inverted or not inverted.
PulseWidth	0–2,000,000	Specifies the duration of the pulse, in seconds. Setting this parameter to 0 sets the digital output continuously on.
Port	-	The physical digital output port connection. Only available ports are shown.

* These parameters are only valid when pulse width is set to 0.

Energy pulsing

You can configure the meter's energy pulsing LEDs or onboard digital outputs for energy pulsing applications.

When an LED or output is set to energy pulsing, the meter sends a readable pulse or signal based on the measured energy source value. This pulse can be used for accuracy verification or as an input to another energy monitoring system.

Default energy pulsing LED sources

Your meter's energy pulsing LEDs have default energy source values configured for accuracy verification testing.

Calibration Pulsar LED	LED Location	Default energy pulsing source
MU Wh Pulsar LED (visible and infrared)	Top of meter body	MU kW tot

NOTE: The energy pulsing LEDs are configured in pairs. For example, changing the energy source value will change it for both the regular and infrared LEDs.

NOTE: To modify your default energy source value, go into the advanced mode of ION Setup and modify the associated Calibration Pulser module. This is an advanced procedure that should only be performed if you have advanced knowledge of ION and the power system your meter is connected to.

See *ION Reference*, available from www.se.com, for more information.

See "Alarm and status LED indicators" on page 154 for information about other LED indicators.

Configuring LED energy pulsing using ION Setup

You can configure your meter's energy pulsing LEDs for energy pulsing using ION Setup.

1. Start ION Setup.
2. Open the **Setup Assistant** for your device.
3. Select **LED pulsing**.
4. Select the tab that corresponds to the energy pulsing LED you want to configure.
5. Configure the following basic parameters for your meter's energy pulsing LEDs.

Energy pulsing LED parameters available through ION Setup

Parameter	Description
Source	Link this input to the value that you want to pulse on the LED.
Enable	Configuring this setting should only be performed by users with advanced knowledge of ION, the device template and the power system the device is connected to.
Int Mode	Specifies the integration mode for the LED (forward, reverse, absolute or net).
Kt	The amount of source energy required to make the LED pulse.
Pulse Width	The minimum time in seconds between LED pulse transitions.
Pulser Mode	Select when the energy pulsing LEDs will pulse: <ul style="list-style-type: none"> • Always: the energy pulsing LEDs are always pulsing based on their energy source value. • Test Only: the energy pulsing LEDs turn off and will not pulse.
Pulse ovrl	Pulsing normally indicates that the energy pulsing LED should be operating normally. Pulsing suspended indicates that the energy pulsing LED is not able to pulse quickly enough. Modify the Kt value to decrease the number of energy pulses or decrease the pulse width, if supported by the device collecting pulses.

NOTE: To perform specialized configuration go into the advanced mode of ION Setup and modify, disable or add a new Calibration Pulser module. These are advanced procedures that should only be performed if you have advanced knowledge of ION and the power system your meter is connected to.

See *ION Reference*, available from www.se.com, for more information.

Configuring digital output energy pulsing using ION Setup

You can configure your meter's onboard digital outputs for energy pulsing using ION Setup.

When configuring your meter, the configuration interface may show all the possible ports, regardless of what is physically available on your meter.

Ensure that the digital output port is available for energy pulsing and not associated with another function.

NOTE: For applications where accuracy is important, use the digital output located on the meter base.

1. Start ION Setup.
2. Open the **Setup Assistant** for your device.
3. Select **Energy pulsing**.
4. Select an energy pulsing source tab (such as Wh Del) to configure energy pulsing using your meter's digital output.

Digital output energy pulsing parameters available through ION Setup

Parameter	Description
Kt	The amount of energy source required to trigger the digital output. For example, in the Wh Del tab, the Kt value would be amount of real energy delivered (Wh Del) per pulse.
Pulse Width	The minimum time in seconds between pulse transitions.
OutputMode	Select the desired output mode: <ul style="list-style-type: none"> • Pulse: the digital output sends a complete pulse when triggered. • KYZ: the digital output makes a transition (off-to-on, or on-to-off) when triggered.
Port	Select an output port from the list. Only available output ports are shown (ports that are not associated with another function).
(energy source) ovrld	Pulsing normally indicates that the output port should be operating normally. Pulsing suspended indicates that the output port is not able to pulse quickly enough. Modify the Kt value to decrease the number of energy pulses.

NOTE: To perform specialized configuration go into the advanced mode of ION Setup and modify or add a new Calibration Pulsar module. This is an advanced procedure that should only be performed if you have advanced knowledge of ION and the power system your meter is connected to.

See *ION Reference*, available from www.se.com, for more information.

Calculate your maximum kWh/pulse (pulse weight) value

To calculate the kWh/pulse (pulse weight) value, divide the highest kW value you can expect by the required pulse rate.

Make sure the required pulse rate does not exceed the maximum pulse rate for the digital output.

NOTE: To convert from kWh/pulse to pulse/kWh you must invert (take the reciprocal) of the value. For example, 1.8 kWh/pulse becomes 0.556 pulse/kWh.

Example pulse weight calculation

For a maximum load of 1600 kW and a pulse rate of two pulses per second, calculate the kWh/pulse value as follows:

1. Convert 1600 kW load into kWh/second:

$$(1600 \text{ kW}) \times (1 \text{ hr}) = 1600 \text{ kWh}$$

$$(1600 \text{ kWh}) / (3600 \text{ sec}) = (X \text{ kWh}) / (1 \text{ sec})$$

$$X = 0.444 \text{ kWh/sec}$$

2. Calculate the kWh required per pulse:

$$(0.444 \text{ kWh/sec}) / (2 \text{ pulses per second}) = 0.222 \text{ kWh/pulse}$$

3. If using KYZ Output Mode, adjust for the KY giving one pulse per two transitions if necessary.

$$(0.222 \text{ kWh/pulse}) / (2) = 0.111 \text{ kWh/pulse}$$

See *ION Reference*, available from www.se.com, for more information about the Calibration Pulser module.

Webpages

Webpage interface

Your meter comes with default webpages that contain typical elements.

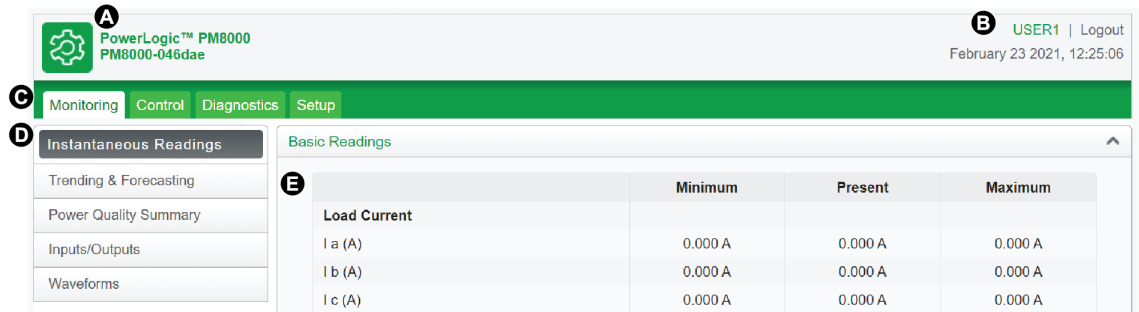

A	Meter type and model, device name
B	Username
C	Main menu
D	Webpage menu
E	Webpage content

NOTE: This graphic is representative only. Your meter’s webpages may appear differently than shown.

Default meter webpages

Default webpages are available on your meter.

Monitoring

Webpage menu	Webpage content
Instantaneous Readings	<ul style="list-style-type: none"> • Basic Readings • Energy Readings • Demand Readings • Voltage Readings • Power Quality
Trending & Forecasting	Select the target and interval for trending and forecasting and view the results.

Webpage menu	Webpage content
Power Quality Summary	<ul style="list-style-type: none"> • Harmonics Chart • ITI (CBEMA)-SEMI • NEMA Motor Derating Curve • EN50160 • IEEE 519 Harmonics
Inputs/Outputs	<ul style="list-style-type: none"> • Digital Inputs • Digital Outputs • Analog Inputs • Analog Outputs
Waveforms	View waveforms from your meter, using the meter's COMTRADE files

Control

Webpage menu	Webpage content
Resets	Perform resets, and view when previous resets were performed.

Diagnostics

Webpage menu	Webpage content
Statistics	<ul style="list-style-type: none"> • Communications • Ethernet • Serial Port • Meter - Basic • Meter - Advanced
Phasor Diagram	View the phasor diagram and numeric values.

Setup

Webpage menu	Webpage content
Ethernet	<ul style="list-style-type: none"> • Basic Settings • Advanced Settings
Serial Port	<ul style="list-style-type: none"> • Basic Settings • Advanced Settings
SNMP Parameters	Configure your meter's SNMP parameters.
NTP	Configure your meter's NTP parameters.
SMTP	Configure your meter's SMTP parameters.

Webpage menu	Webpage content
Date & Time	Configure your meter's time and time synchronization.
Preferences	Enter your meter's nameplate information.
Metering	<ul style="list-style-type: none"> • Basic Settings • Advanced Settings
HTTPS	Certificate Management.

Maintenance

Webpage menu	Webpage content
—	<p>Custom. No default content.</p> <p>By default the Maintenance menu is empty, and the menu is not displayed until information is added to it.</p>

Accessing webpages for data viewing and meter configuration

You can access the meter's webpages through the meter's Ethernet connection using a web browser.

You must have cookies enabled to access your meter's webpages.

You may need to configure your meter's security settings to view webpages and configure your meter using webpages.

On a hardware-locked meter, you cannot add, delete, or modify any webpage files.

If you are connected to your device over Ethernet, changing Ethernet configuration parameters without another method of configuration enabled may cause loss of communications with your device and render it inaccessible.

NOTICE

LOSS OF ACCESS

Ensure you maintain sufficient access to communicate with and configure your device.

Failure to follow these instructions can result in loss of access to the device.

1. Open a web browser and enter your meter's IP address in the address bar. The webpage login prompt is displayed.

If the browser cannot connect to the webserver, check the web protocol setting.

2. Enter a valid username and password.
3. Select your desired **Language** from the drop-down list box, and click **Log In**.

Your meter's webpages are displayed. The default page is the **Monitoring** webpage, showing real-time data.

4. Select the main menu tab that corresponds to the category of information you want to view and select the webpage menu from the list.
The webpage content is displayed.
5. Click the webpage content headings to expand and view the meter's data.
6. Select **Setup** to view and edit your meter's configuration.

Embedding images and files in meter webpages

Upload images, documents, audio and video files to meter webpages using SFTP.

NOTE: Images cannot be scaled after they are uploaded. Format images to the desired size before uploading.

1. Access your meter's internal SFTP site.
2. Open the **web** folder. Copy your file into the subfolder that corresponds to the webpage main menu tab you want to access your file from.
3. Connect to your meter's webpages. Select the main menu item that corresponds to the folder you previously selected. Your file is listed in the webpage menu.
4. Select your file from the webpage menu to view it.

Creating custom webpages

Create custom webpages to view data or access configuration parameters from your meter.

Download the meter's Modbus registers map from www.se.com.

1. Open SFTP client software.
2. Go to **web > examples**. Select `sample readings.html` to create a data value webpage or `sample configuration.html` to create a configuration parameters webpage.
3. Save a copy of the sample file. This filename is the webpage name.
4. Open your webpage in an HTML or webpage editor program.
5. Modify the webpage to reference the desired meter data or parameters from the Modbus registers map, and update the other fields where required.
6. Save your custom webpage.

The meter will display translated content if it exists in the meter's memory. If translated content is not available, English is displayed.

7. Connect to your meter's internal SFTP site.
 - If you have created a data viewing webpage, copy your custom webpage to **web > monitoring**.
 - If you have created a configuration webpage, copy your custom webpage to **web > setup**.
8. Login to your meter's webpages.

Your custom webpage is available from the webpage menu under the **Monitoring** (data viewing) or **Setup** (configuration) tab.

Watch the video on how to create custom webpages: [How to Create Custom Webpages for Your Meter](#)

Deleting custom webpages

1. Open the SFTP client software.
2. Connect to the meter using the meter's IP address and SFTP port number. See "Protocols, ports, and connections" on page 65 for information on port numbers.
3. Open the **web** folder in SFTP file directory and delete all files in subfolders.
4. Close the SFTP client software.

Loading webpages using ION Setup

Prerequisites:

- Webpage files in the upgrade .zip folder. Go to www.se.com to download upgrade files.
- Meter connection using SFTP client application.

To load webpages using ION Setup:

1. Obtain the webpage upgrade files (.zip folder) that you want to upload onto your meter. Save the files where they can be accessed by the computer running ION Setup.
2. Start ION Setup.
3. Open the **Setup Assistant** for your meter.
4. Click **Template > Web**.

NOTE: You can preview meter webpages using the **Test Web Viewing** feature. Select an IP addressing method from the drop-down list box to generate a test link using your default web browser.

5. Click **Upload** to navigate to the folder (.zip) containing the meter upgrade files. Select the folder and click **Open**.
6. An ION Setup dialog box will open. Click **Yes** to confirm uploading of the webpage files.

NOTE: The upload process replaces files with matching filenames only.

Confirmation of uploaded files is displayed in the bottom status bar.

Loading webpages using SFTP

You can upgrade your meter's webpages using your meter's internal SFTP site.

Prerequisites:

- Your meter's webpage upgrade files. Go to www.se.com to download upgrade files.
- Access to your meter's internal SFTP site.

To load webpages using SFTP:

1. Connect to your meter's internal SFTP site and open the **web** folder.
2. Navigate to the location on your local machine where you saved the webpage .zip file.

NOTE: Extract the contents of the upgrade file.

3. Drag the **resources** and **examples** folders into the **web** folder. Confirm to overwrite existing files when prompted.

The files are transferred to the meter.

Sample data viewing webpage

You can create custom data viewing webpages using the sample webpage stored on your meter.

The sample webpages are stored in the **documents** folder on your meter's internal SFTP site.

Your meter's Modbus register map is available from www.se.com.

If required, your meter's ION handles document is packaged with the meter firmware file which is available for download from www.se.com.

The data viewing webpage must be stored on your meter's internal SFTP site in the **web/monitoring** folder. The custom webpage is viewed by selecting the **Monitoring** main menu tab on your meter's webpage.

Configuring the HTML code other than where described is an advanced procedure and should only be performed by those with an advanced understanding of webpages and how your meter processes them.

Sample webpage data viewing result

NOTE: The following graphic is representative only. Your meter's webpages may appear different than shown.

		Minimum	Present	Maximum
I a (A)	D	0.00	F 3.75	3.75
I b (A)		0.00	5.01	5.01

A	HTML filename
B	Content pane title
C	Row heading
D	Units
E	Column heading

F	Named register instantaneous value
G	Second content pane A title

Sample HTML code for data viewing webpage content

Content and formatting of a data viewing webpage is controlled by its HTML code.

Sample data viewing webpage content

```

1 | SampleMonitorPane.html
2 |     <div class="content-fit">
3 |     <div class="accordion">
4 | <h3 target="sample-readings">%localizedString(Basic Readings)#$/h3>
5 |     <div id="sample-readings">
6 |     <table class="datatable">
7 |         <tr>
8 |             <th>&nbsp;</th>
9 |             <th>%localizedString(Minimum)#$/th>
10 |            <th>%localizedString(Present)#$/th>
11 |            <th>%localizedString(Maximum)#$/th>
12 |        </tr>
13 |        <tr class="minor">
14 |            <td>%localizedString(I a)#$ <span unitsreg="I a"></span></td>
15 |            <td regname="I a mn"></td>
16 |            <td regname="I a"></td>
17 |            <td regname="I a mx"></td>
18 |        </tr>
19 |        <tr class="minor">
20 |            <td>%localizedString(I b)#$ <span unitsreg="I b"></span></td>
21 |            <td regname="I b mn"></td>
22 |            <td regname="I b"></td>
23 |            <td regname="I b mx"></td>
24 |        </tr>
25 |    </table>
26 |    </div>
27 | <h3 target="sample-energy">%localizedString(Energy Readings)#$/h3>
28 |     <div id="sample-energy">
29 |     <table class="datatable">
30 |         <tr>
31 |             <th>&nbsp;</th>
32 |             <th>%localizedString(Present)#$/th>
33 |         </tr>
34 |         <tr>
35 |             <td>%localizedString(Active Energy)#$ <span unitsreg="kWh del-rec"></span></td>
36 |             <td regname="kWh del-rec"></td>
37 |         </tr>
38 |         <tr>
39 |             <td>%localizedString(Reactive Energy)#$ <span unitsreg="kVARh del-rec"></span></td>
40 |             <td regname="kVARh del-rec"></td>
41 |         </tr>
42 |     </table>
43 |     </div>
44 | </div>
45 |
46 |
47 | <script type="text/javascript">
48 |
49 | instantaneousReadings.initInstantaneousReadings('sample-readings');
50 |
51 | </script>
52 | </div>

```

Sample webpage data viewing content description

Line #	Description
	<code>SampleMonitorPane.html</code>
1	The HTML filename, including the HTML extension (.html). This filename must comply with SFTP filename requirements (no spaces or special characters). The filename (without the HTML extension) is the name shown on the webpage menu.
	<code><h3 target="sample-readings"></code>
4	This creates the first webpage content pane. "sample-readings" is the name of the webpage content. This name must be unique.
	<code> \$%localizedString(Basic Readings) #\$/h3></code>
	Basic Readings is the title of the webpage content pane. This title is translated if possible.
	<code><div id="sample-readings"></code>
5	This must match the name of the webpage content in line 4.
	<code><th>\$%localizedString(Minimum) #\$/th></code>
9	Minimum is the heading for the first column. This heading is translated if possible.
	<code><th>\$%localizedString(Present) #\$/th></code>
10	Present is the heading for the second column. This heading is translated if possible.
	<code><th>\$%localizedString(Maximum) #\$/th></code>
11	Maximum is the heading for the last column. This heading is translated if possible.
	<code><td>\$%localizedString(I a) #\$/td></code>
14	I a is the row heading. This heading is translated if possible.
	<code></td></code>
	This displays the units that the meter has defined for the named register I a.
	<code><td regname="I a mn"></td></code>
15	This displays the instantaneous value of the named register I a mn.
	<code><td regname="I a"></td></code>
16	This displays the instantaneous value of the named register I a.
	<code><td regname="I a mx"></td></code>
17	This displays the instantaneous value of the named register I a mx.

Line #	Description
20	<pre><td>\${%localizedString(I b)} # \$</pre> <p>I b is the second row heading. This heading is translated if possible.</p> <pre></td></pre> <p>This displays the units that the meter has defined for the named register I b.</p>
21	<pre><td regname="I b mn"></td></pre> <p>This displays the instantaneous value of the named register I b mn.</p>
22	<pre><td regname="I b"></td></pre> <p>This displays the instantaneous value of the named register I b.</p>
23	<pre><td regname="I b mx"></td></pre> <p>This displays the instantaneous value of the named register I b mx.</p>
27	<pre><h3 target="sample-energy"></pre> <p>This creates the second webpage content pane. Sample-energy is the name of the webpage content. This name must be unique.</p> <pre> \${%localizedString(Energy Readings)} # \$ </h3></pre> <p>Energy Readings is the title of the webpage content pane. This title is translated if possible.</p>
28	<pre><div id="sample-energy"></pre> <p>This must match the name of the webpage content in line 27.</p>
32	<pre><th>\${%localizedString(Present)} # \$ </th></pre> <p>Present is the heading for the last column. This heading is translated if possible.</p>
35	<pre><td>\${%localizedString(Active Energy)} # \$</pre> <p>Active Energy is the row heading. This heading is translated if possible.</p> <pre></td></pre> <p>This displays the units that the meter has defined for the named register kWh del-rec.</p>
36	<pre><td regname="kWh del-rec"></td></pre> <p>This displays the instantaneous value of the named register kWh del-rec.¹</p>
39	<pre><td>\${%localizedString(Reactive Energy)} # \$</pre> <p>Reactive Energy is the row heading. This heading is translated if possible.</p> <pre></td></pre> <p>This displays the units that the meter has defined for the named register kVARh del-rec.</p>

Line #	Description
40	<pre><td regname="kVARh del-rec"></td></pre> <p>This displays the instantaneous value of the named register kVARh del-rec.¹</p>
49	<pre>instantaneousReadings.initInstantaneousReadings('sample-readings');</pre> <p>Sample-readings is the unique name of the first webpage content name. This HTML code updates all the webpage's values.</p>

Sample setup webpage

You can create custom setup webpages using the sample webpage stored on your meter.

Sample webpages are stored in the **documents** folder on your meter's internal SFTP site.

Your meter's Modbus register map is available from www.se.com.

If required, your meter's ION handles document is packaged with the meter firmware file which is available for download from www.se.com.

Custom setup webpages must be stored on your meter's internal SFTP site in the **web/setup** folder. The custom webpage is viewed by selecting the **Setup** main menu tab on your meter's webpage.

Configuring the HTML code other than where described is an advanced procedure and should only be performed by those with an advanced understanding of webpages and how your meter processes them.

Sample webpage setup result

NOTE: The following graphic is representative only. Your meter's webpages may appear different than shown.

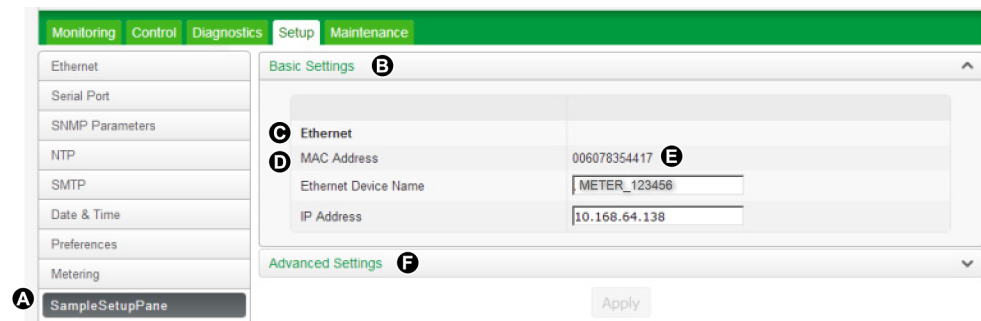

A	HTML filename
B	Content pane title
C	Sub-heading
D	Row heading

¹Named registers are listed in the Modbus registers map. You can also reference a value by its ION handle using the following format: `<td regname="_0x####"></td>`.

E	Named register value
F	Second content pane title

Sample HTML code for setup webpage content

Content and formatting of a setup webpage is controlled by its HTML code.

Sample setup webpage content

```

1  SampleSetupPane.html
2
3  <div class="content-fit">
4  <form id="formSampleSettings">
5
6  <div class="accordion">
7  <h3 target="sample-basic">%localizedString(Basic Settings)#$/h3>
8  <div id="sample-basic">
9  <table class="formtable">
10 <tr>
11 <th>&nbsp;&nbsp;&nbsp;</th>
12 <th>&nbsp;&nbsp;&nbsp;</th>
13 </tr>
14 <tr>
15 <td>%localizedString(Ethernet)#$/td>
16 <td>&nbsp;&nbsp;&nbsp;</td>
17 </tr>
18 <tr class="minor">
19 <td>%localizedString(MAC Address)#$/td>
20 <td regname="MAC Address"></td>
21 </tr>
22 <tr class="minor">
23 <td>%localizedString(Ethernet Device Name)#$/td>
24 <td><input name="Ethernet Device Name" type="text" /></td>
25 </tr>
26 <tr class="minor">
27 <td>%localizedString(IP Address)#$/td>
28 <td><input name="IP Address" type="text" /></td>
29 </tr>
30 </table>
31
32 </div>
33
34 <h3 target="sample-advanced">%localizedString(Advanced Settings)#$/h3>
35 <div id="sample-advanced">
36 <table class="formtable" id="frameFormatDropdownContainer">
37 <tr>
38 <th>&nbsp;&nbsp;&nbsp;</th>
39 <th>&nbsp;&nbsp;&nbsp;</th>
40 </tr>
41 <tr>
42 <td>%localizedString(TCP Keep Alive Minutes)#$/td>
43 <td><input type="text" name="TCP Keep Alive Minutes" class="small" /> <span unitsreg="TCP Keep
44 Alive Minutes"></span></td>
45 </tr>
46 <tr>
47 <td>%localizedString(Enable Web Server)#$/td>
48 <td><select name="Enable Web Server"></select> </td>
49 </tr>
50 </table>
51 </div>
52 </div>
53
54 <input type="submit" class="apply" value='"%localizedString(Apply)#$' />
55

```

```

56 | </form>
57 |
58 |
59 | <script type="text/javascript">
60 |
61 | SetupPane.init('formSampleSettings');
62 | formChangeDetection.initFormChangeDetection('#formSampleSettings', '#dialogFormChanges');
63 |
64 | </script>
65 | </div>

```

Sample setup webpage content description

Line #	Description
	SampleSetupPane.html
1	The HTML filename, including the HTML extension (.html). This filename must comply with SFTP filename requirements (no spaces or special characters). The filename (without the HTML extension) is the name shown on the webpage menu.
4	<pre><form id="formSampleSettings"></pre> <p>"formSampleSettings" is the name of the webpage content. This name must be unique</p>
7	<pre><h3 target="sample-basic"></pre> <p>This creates the first webpage content pane. "sample-basic" is the name of the webpage content. This name must be unique.</p> <pre> %localizedString(Basic Settings) #</h3></pre> <p>Basic Settings is the title of the webpage content pane. This title is translated if possible.</p>
8	<pre><div id="sample-basic"></pre> <p>This must match the name of the webpage content in line 7.</p>
15	<pre><td>%localizedString(Ethernet) #</td></pre> <p>Ethernet is the subheading. This heading is translated if possible.</p>
19	<pre><td>%localizedString(MAC Address) #</td></pre> <p>MAC Address is the row heading. This heading is translated if possible.</p>
20	<pre><td regname="MAC Address"></td></pre> <p>This displays the value of the read-only named register MAC Address.</p>
23	<pre><td>%localizedString(Ethernet Device Name) #</td></pre> <p>Ethernet Device Name is the row heading. This heading is translated if possible.</p>

Line #	Description
24	<pre><td><input name="Ethernet Device Name" type="text" /></td></pre> <p>This displays the instantaneous value of the configurable named register Ethernet Device Name in a text-edit field.</p> <p>The type must match the named register type, in this case, an alphanumeric string.</p>
27	<pre><td>\${%localizedString(IP Address)}#</td></pre> <p>IP Address is the row heading. This heading is translated if possible.</p>
28	<pre><td><input name="IP Address" type="text" /></td></pre> <p>This displays the instantaneous value of the configurable named register IP Address in a text-edit field.</p> <p>The type must match the named register type, in this case, an alphanumeric string.</p>
34	<pre><h3 target="sample-advanced"></pre> <p>This creates the second webpage content pane. Sample-advanced is the name of the webpage content. This name must be unique.</p> <pre> \${%localizedString(Advanced Settings)}#</h3></pre> <p>Advanced Settings is the title of the webpage content pane. This title is translated if possible.</p>
35	<pre><div id="sample-advanced"></pre> <p>This must match the name of the webpage content in line 34.</p>
42	<pre><td>\${%localizedString(TCP Keep Alive Minutes)}#</td></pre> <p>TCP Keep Alive Minutes is the row heading. This heading is translated if possible.</p>
43	<pre><td><input type="text" name="TCP Keep Alive Minutes" class="small" /></pre> <p>This displays the instantaneous value of the configurable named register TCP Keep Alive Minutes in a text-edit field.</p> <p>The type must match the named register type, in this case, an alphanumeric string.</p>
46	<pre></td></pre> <p>This displays the units that the meter has defined for the named register TCP Keep Alive Minutes.</p> <p>NOTE: There are no defined units for TCP Keep Alive Minutes, so no units are displayed.</p>
46	<pre><td>\${%localizedString(Enable Web Server)}#</td></pre> <p>Enable Web Server is the row heading. This heading is translated if possible.</p>
47	<pre><td><select name="Enable Web Server"></select> </td></pre> <p>Enable Web Server is the named register that is displayed. Named registers are listed in the meter's registers map.</p> <p>The type must match the named register type, in this case, an enumerated value that is displayed as a drop-down list box.</p>

Line #	Description
61	<pre>SetupPane.init('formSampleSettings');</pre> <p>This must match the webpage content name from line 4.</p>
62	<pre>formChangeDetection.initFormChangeDetection('#formSampleSettings', '#dialogFormChanges');</pre> <p>This must match the webpage content name from line 4. This HTML code updates all the webpage's values.</p>

Display

Display overview

The display allows you to view meter data and perform basic configuration.

NOTE: The display backlight dims after a defined period of inactivity. When the meter detects an unacknowledged active high priority alarm, the display flashes until the alarm is acknowledged.

Display

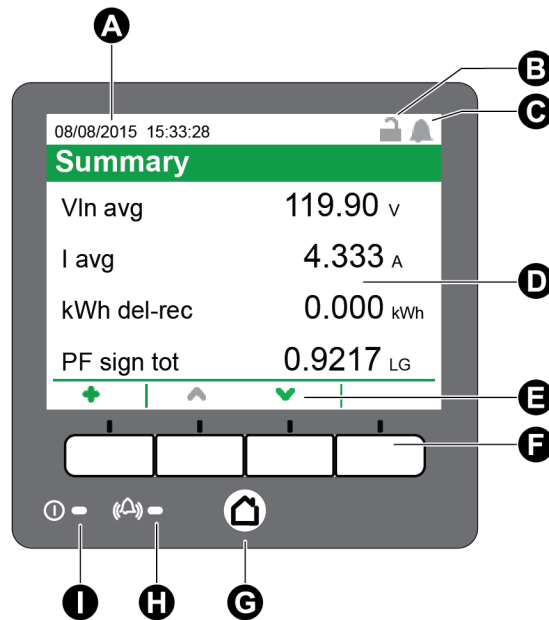

Display

A	Date/time
B	Revenue lock icon
C	Alarm icon
D	Display
E	Navigation icons
F	Navigation buttons
G	Home button
H	Alarm LED
I	Status LED

Home button

Pressing the home button takes you to the associated menu screen. If you are in a data screen, pressing the home button takes you to the display menu, and pressing home twice takes you to the summary display screen. If you are in a setup screen, pressing home takes you to the setup

menu, and pressing home again takes you to the display menu.

Revenue lock icon

The revenue lock icon indicates the lock status of the meter.



When gray and open, the meter is unlocked. When green and closed, the meter is locked. You can lock and unlock your meter using the revenue lock switch located on the body of your meter.

Alarm icon

The alarm icon indicates the highest level and state of alarms detected by your meter.

For example, if the meter detects a low priority and a high priority active alarm, the alarm icon indicates a high priority active alarm.

NOTE: Alarms can only be viewed and acknowledged through the display.

Icon	Description
	<p>Active alarm indicator:</p> <ul style="list-style-type: none"> • Red: high priority alarm state detected • Yellow: medium priority alarm state detected • Blue: low priority alarm state detected <p>The alarm indicator flashes until you acknowledge the alarm.</p> <p>The alarm indicator changes to the historic alarm indicator of the appropriate level when the alarm state is no longer detected by the meter.</p> <p>NOTE: The display backlight flashes for unacknowledged high priority active alarms.</p>
	<p>Unacknowledged historic alarm indicator:</p> <ul style="list-style-type: none"> • Red: unacknowledged high priority historic alarm • Yellow: unacknowledged medium priority historic alarm <p>NOTE: Low priority historical alarms are not indicated.</p> <p>The active alarm indicator changes to the historic alarm indicator of the appropriate level when the alarm state is no longer detected by the meter.</p>
	<p>Gray: no active or unacknowledged high or medium priority historic alarms</p>

Alarm and status LED indicators

Your meter has alarm and status LEDs.







These LEDs cannot be configured for other uses.







LED	Description
Status	Off: unpowered
	Steady green: normal operation
	Flashing red: no communications (remote display only)
	Steady red: firmware upgrade required (remote display only)
	Flashing red/green: startup or firmware upgrade sequence in progress
Alarm	Off: no active or unacknowledged historic alarms
	On: acknowledged active alarm
	Flashing: active alarm
<p>NOTE: The display backlight flashes for unacknowledged high priority active alarms.</p>	

Navigation symbols

Navigation symbols are displayed on the bottom of the screen above their corresponding navigation button.

NOTE: If the symbol is gray, that navigation function is not available.

Symbol	Description
	More Pressing this button displays additional screens.
	Left Pressing this button moves the displayed cursor one position to the left. If you are in a more or info screen, it returns you to the previous screen.
	Right Pressing this button moves the displayed cursor one position to the right.
	Up Pressing this button takes you to the previous screen or menu item.
	Down Pressing this button takes you to the next screen or menu item.
	Select Pressing this button selects or confirms the highlighted value.
	Cancel Pressing this button cancels the current selection and returns you to the previous screen.

Symbol	Description
	Graphic Pressing this button takes you to a graphical data display.
	Numeric Pressing this button takes you to a numeric data display.
	Info Pressing this button takes you to a detailed information screen.
	Edit Pressing this button allows you to edit the displayed parameter.
	Pressing these buttons allow you to navigate parameter tables in the setup screens.
	Pressing both buttons allows you to perform the described action.

Using the onscreen keyboard

Use the onscreen keyboard to enter login credentials on your meter's display.

When advanced security is enabled on your device using ION Setup, many functions require you to provide your advanced security username and password. Use the onscreen keyboard to enter these credentials.



When you access a feature that requires your username and password, the onscreen keyboard appears.



1. Use the left, right and up buttons to move the highlighted key.

Pressing up from the top row returns the highlighted key to the bottom row and pressing left or right at the end of one side causes the highlighted key to wrap around to the opposite side.

2. Press select to input the highlighted key.

- Select  to switch to the uppercase keyboard characters and select  again to switch back.
- Use  to delete the last character entered.

3. Enter your username and select .

The Enter Password field appears.

NOTE: When entering your username, the meter ignores any leading zeros. For example, USER1, USER01 and USER001 are all recognized by the meter as USER1.

4. Enter your password and select  .

If the username or password is not correct, a security message is displayed. All invalid access attempts are recorded in the event log.

More screens access

You can access additional screens.

Pressing the More button opens a list of additional screens related to the active screen. Press cancel to close the list. If you do not select a screen, you are returned to the last data screen displayed.

Overrange indication

If any value measured by the meter is too large to fit on the display, the meter initially reduces the size of the text to try and make the value fit.

If the value is still too large to be displayed, the meter truncates the value starting with the least significant digit and encloses the truncated value in a red box.

Auto-scaling feature

Measurement units on the meter display and webpages automatically scale, depending on the value of PT Primary and CT Primary.

Voltage units are scaled based on the PT Primary value:

PT Primary value	Units or scaling
< 1000	V
1000–999,999	kV

Current units are scaled based on the CT Primary value:

CT Primary value	Units or scaling
< 1000	A
1000–999,999	kA

Power units are scaled according to the value of (CT Primary x PT Primary x 3):

(CT Primary x PT Primary x 3) value	Units or scaling
< 1,000,000	kW, kVAR or kVA
1,000,000–999,999,999	MW, MVAR or MVA
≥ 1,000,000,000	GW, GVAR or GVA

Display screens

Display menu

The display menu allows you to select data for viewing and to access the setup menu.

Data display screens

Your meter's default display screens show measured and calculated information about the power system being monitored.

Menu	Submenu	Content
Summary	Summary	Power system summary
Alarms	Active alarms,	Active alarms can be viewed and acknowledged.
	Historical alarms	Historical alarms can be viewed and acknowledged.
Basic readings	Voltage	<ul style="list-style-type: none"> Power system voltage (line-to-line or line-to-neutral), current and frequency values. Average, minimum and maximum values are also provided.
	Current	
	Frequency	
Power	Power summary	Per-phase and total kW, kVAR and kVA values, along with minimum and maximum values.
	Demand	Delivered and received demand values including peak demand.
	Power factor	Per-phase and total power factor along with minimum and maximum values.
Energy	Energy	Energy delivered-received, delivered and received.
Events	Events	Meter event log entries listing and details.
Power quality	EN50160	EN50160 values.
	Harmonics	Voltage and current harmonics, with individual and total harmonic values.
	Phasors	Phasor diagram with magnitude and angle values.
Inputs/outputs	Digital inputs	Digital and analog I/O values and counts.
	Digital outputs	
	Analog inputs	
	Analog outputs	

Menu	Submenu	Content
Nameplate	Nameplate	<ul style="list-style-type: none"> • Owner and tag information, meter model and serial number. • Meter feature set, firmware version, firmware CRC, and pulse constant. • Template information (MID/MIR meter only) • RMD serial number and firmware version. • Meter volts mode, meter nominals (voltage, current, and frequency), and PT/CT ratio. • Demand configuration values. • Regulation tag.
Custom screens	—	Custom screens
Setup Menu	—	Access to the setup menu screens.

Setup menu

Meter configuration can be performed through the display.

Configure your meter's security settings to allow front panel (display) programming to set up the meter using the display.

NOTE: Your display may appear differently than shown, depending on your meter's power system, configuration, and display settings.

NOTE: Some setup parameters cannot be configured when revenue security is enabled.

Menu	Submenu
Meter Setup	Volts Mode
	PT/CT Setup
	Voltage Polarity Setup
	Current Polarity Setup
	Nominal Values
Ethernet Port Enable Setup	Ethernet Port Enable Setup

Menu	Submenu
Communications Setup	IPv4 Assignment Mode Setup
	Stored IPv4 Address Setup
	IPv6 Link Local Address
	IPv6 Assignment Mode Setup
	Stored IPv6 Global Address
	Ethernet Device Name
	DNS Setup
	COM1 Setup
	COM2 Setup
	COM3 Setup
	COM4 Setup
	NTP Address
	SMTP Address
Display Setup	Screen Setup
	Label & Symbol Setup
	Numeric Format Setup
Date/Time/Clock Setup	Date & Time Setup
	Clock Setup
Alarm Setup	Alarm Setup
Language Setup	Language Setup
Time of Use Setup	TOU Active Rates
	TOU Season
Resets	Resets
Password Setup	Password Setup

Meter setup using your display

Navigate to Setup screens and enter parameters to configure your meter.

Your meter's default display password is 0 (zero).

NOTE: Your meter locks you out of display configuration after you have exceeded the maximum number of attempts to enter a password.

The following example shows how to use the navigation buttons to select parameters, enter numeric information or select parameter values from lists.

NOTE: Your display may appear differently than those shown, depending on your meter's power system and display and localization settings.

Example: Setting volts mode and PT/CT ratios

Use the display navigation buttons to set your meter's volts mode and PT ratios.

NOTE: Potential transformers (PT) are also known as voltage transformers (VT).

1. Press to display the menu. Press until **Setup Menu** is highlighted. Press to display the Setup Menu. The Setup Menu lists the setup selections on your meter.

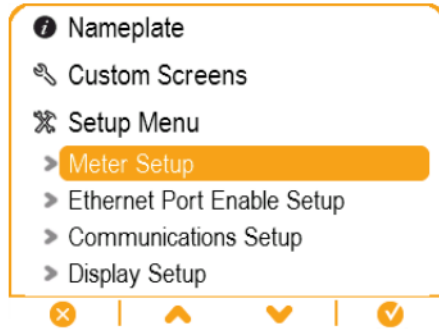

2. Press or to highlight the different setup menu selections. Highlight **Meter Setup** and press to select the meter setup screens. The **Volts Mode** setup screen is displayed.
3. Press to highlight **Volts Mode**. Press to edit the volts mode. The Enter Password screen is displayed.

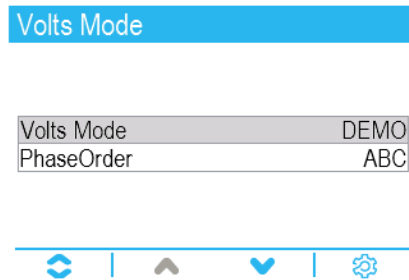

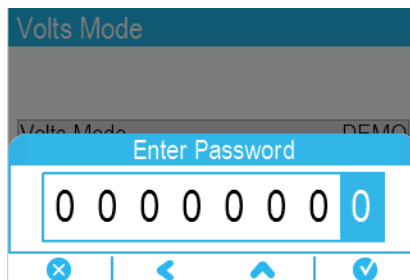

4. Press to change the value of the highlighted digit (0 - 9). Press to go to the next digit. Press to enter your password using the onscreen keyboard. The **Volts Mode** configuration screen is displayed.





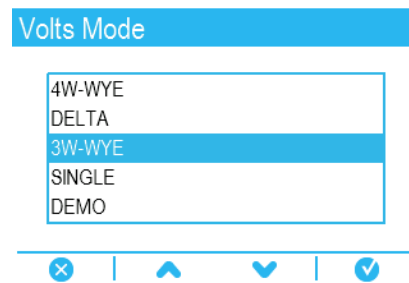

5. Press or to highlight the desired volts mode from the list, in this case, 3W-WYE. Press to select the highlighted volts mode. A confirmation screen is displayed, showing

your meter's previous setting and newly selected setting.

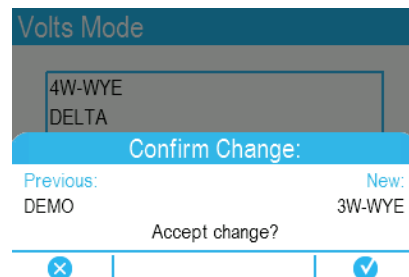







6. Press  to confirm, and the new setting is applied to your meter. Press  to cancel and maintain your meter's original setting.

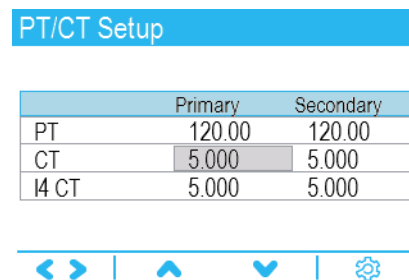

7. In the Volts Mode screen, press  to go to the PT/CT Setup screen.
8. In the PT/CT Setup screen, press   to highlight the potential transformer (PT) or current transformer (CT) value for editing. Press  to edit the highlighted value.

NOTE: If you have exceeded the password timeout period, you are prompted to enter your meter's display password.



9. Press  to change the value of the highlighted digit (0 - 9). Press  to go to the next digit. Press  to enter the new value. When the confirmation screen is displayed, press  to confirm the new value or  to revert to the original value.

Display setup

You can configure basic display parameters using the display.

Screen setup

Parameter	Values	Description
Backlight Timeout	0–7200	Specifies how many seconds the display's backlight remains lit after the last button press

Label and symbol setup

Parameter	Values	Description
Phase Lbls	ABC, 123	Sets the voltage and current phase labels
Measurement Symbols	IEEE, IEC	Specifies whether IEEE or IEC measurement symbols are applied to displayed values
PF Convention	IEEE, IEC	Specifies whether IEEE or IEC power factor conventions are applied to displayed values

Numeric format setup

Parameter	Values	Description
Digit Grouping	1000.0, 1,000.0, 1 000,0	Specifies how digits are grouped for display
Volts Resolution	1., 1.X, 1.XX, 1.XXX, 1.XXXX	Specifies the number of decimal places displayed for voltages
Current Resolution	1., 1.X, 1.XX, 1.XXX, 1.XXXX	Specifies the number of decimal places displayed for currents
Power Resolution	1., 1.X, 1.XX, 1.XXX, 1.XXXX	Specifies the number of decimal places displayed for power and energy measurements

Language setup

Set your meter display to one of the following languages:

- English (default)
- Spanish
- French
- Russian
- German
- Italian
- Portuguese
- Chinese (simplified)

Creating custom displays using ION Setup





Use ION Setup to create new custom displays.

1. Start ION Setup.
2. Open the **Setup Assistant** for your meter.

3. Click **Displays > Front Panel**.
4. Select **Displays** and click **Edit**.
ION Setup loads your meter's display information into the **Display Editor** screen.
5. Select the display mode of the custom screens from the drop-down list box, and rename, delete, or change the order of custom displays.
 - a. Click **New** to add a new display screen in the selected display mode.
 - b. Click **Edit** to open the **Display setup** screen, where you can configure new or existing custom displays.
6. Configure your screen.
 - **Screen Type**: Specify the number of parameters displayed on the screen.
 - **Screen Title**: Enter the title to be shown at the top of your custom display.
7. Click **Edit** to select the displayed parameters.
The number of parameters displayed is determined in the **Screen Type** selection described above.
8. Select your digit display properties.
 - **Resolution**: Specifies the number of decimal places displayed.
 - **Last Digit**: Specifies if the last digit is rounded or truncated.
9. Click **Send** to save the changes in the meter.

Remote display troubleshooting icons

The remote display shows troubleshooting icons in addition to the meter's status LED information.

Icon	Description
	The display is connecting to your meter.
	The display cannot communicate to your meter. Check the connection between your meter and the display. Check the meter's status LED to confirm that the meter is operating normally.
	The display needs updated firmware for compatibility with your meter.
	The display is downloading a firmware upgrade. Do not disconnect the display from your meter.
	The display is undergoing a firmware upgrade. Do not disconnect the display from your meter.

Alarms and alerts

Alarms

An alarm is the meter's means of notifying you when an alarm condition is detected, such as an error or an event that falls outside of normal operating conditions. Alarms are typically setpoint-driven and can be programmed to monitor certain behaviors, events, or unwanted conditions in your electrical system.

You can configure your meter to generate and display high, medium, and low priority alarms when predefined events are detected in the meter's measured values or operating states. Your meter also logs the alarm event information.

The meter ships with some alarms already enabled from the factory. Other alarms need to be configured before the meter can generate alarms.

Customize meter alarms as required, such as changing the priority. You can also create custom alarms using the advanced features of your meter.

Alarm types

Your meter has four types of alarms:

Alarm type	Description
Setpoint (standard)	Setpoint alarms compare the actual value of a parameter to a specified limit or range of values. These include measured voltage and current values and calculated power quality values. Some setpoint alarms use high-speed measurements for up to 1 millisecond resolution.
Digital	Digital alarms are triggered on a digital input's on/off state.
Disturbance (sag/swell)	Disturbance alarms are triggered on a measured sag or swell.
Unary	Unary alarms are not configurable and generate an alarm based on the meter's state, for example, the meter powering up.

Alarms have two states:

Alarm state	Description
Active	The meter detects the alarm condition is met.
Historical	The alarm condition previously existed but the condition has since returned to a non-alarm state.

See *ION Reference*, available from www.se.com, for more information about Setpoint, Relative Setpoint, Digital Input, Disturbance Analyzer, and Sag/Swell modules.

Standard and high-speed alarms

Alarm speed is determined by the update rate of the framework for the particular alarm.

Standard alarm

Standard alarms have a detection rate of once every one second.

High-speed alarm

High-speed alarms have a detection rate of once every half-cycle.

3-phase alarms

Alarms on 3-phase systems are evaluated per phase and reported for each phase.

Some alarms, such as the sag/swell alarm, are evaluated per phase, but reported as a single alarm: Each of the three phases are evaluated for the setpoint condition individually, but there is only one alarm generated. The alarm pickup occurs when the first phase exceeds the alarm pickup magnitude for the pickup time delay. The alarm is active as long as any phase remains in an alarm state. The alarm dropout occurs when the last phase drops below the dropout magnitude for the dropout time delay.

Over and under setpoint (standard) alarm operation - Example

The meter supports over and under setpoint conditions on standard alarms.

A setpoint condition occurs when the magnitude of the signal being monitored crosses the limit specified by the pickup setpoint setting and stays within that limit for a minimum time period specified by the pickup time delay setting.

The setpoint condition ends when the magnitude of the signal being monitored crosses the limit specified by dropout setpoint setting and stays within that limit for a minimum time period specified by dropout time delay setting.

Over setpoint

When the value rises above the pickup setpoint setting and remains there long enough to satisfy the pickup time delay period ($\Delta T1$), the alarm condition is set to ON. When the value falls below the dropout setpoint setting and remains there long enough to satisfy the dropout time delay period ($\Delta T2$), the alarm condition is set to OFF.

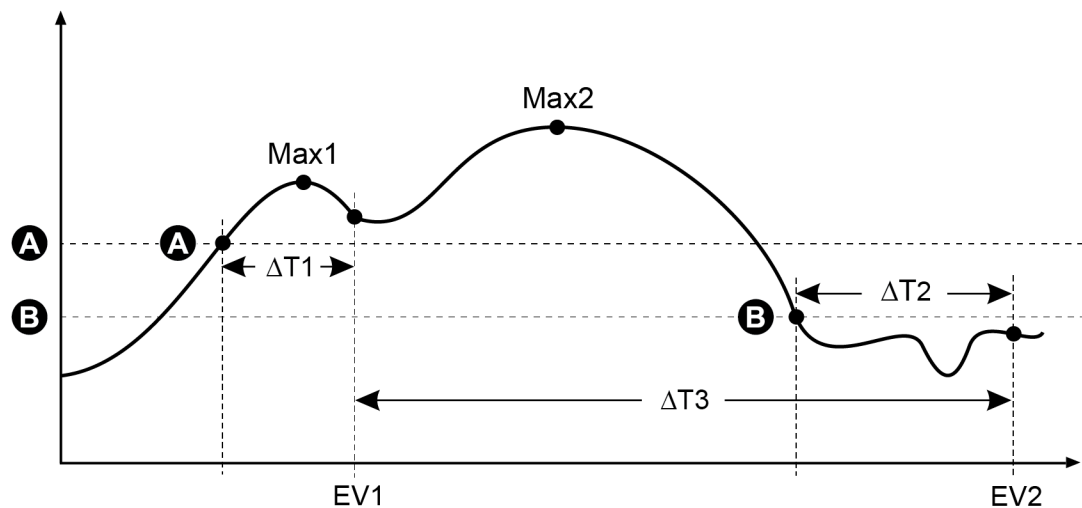

A	Pickup setpoint
B	Dropout setpoint
$\Delta T1$	Pickup time delay period (in seconds)
EV1	Start of alarm condition
$\Delta T2$	Dropout time delay (in seconds)
EV2	End of alarm condition
$\Delta T3$	Alarm duration (in seconds)
Max1	Maximum value recorded during pickup period
Max2	Maximum value recorded during alarm period

The meter records the date and time when the alarm event starts (EV1) and when it ends (EV2). The meter also performs any task assigned to the event, such as operating a digital output. The meter also records maximum values (Max1, Max2) before, during or after the alarm period.

Under setpoint

When the value falls below the pickup setpoint setting and remains there long enough to satisfy the pickup time delay period ($\Delta T1$), the alarm condition is set to ON. When the value rises above the dropout setpoint setting and remains there long enough to satisfy the dropout time delay period ($\Delta T2$), the alarm condition is set to OFF.

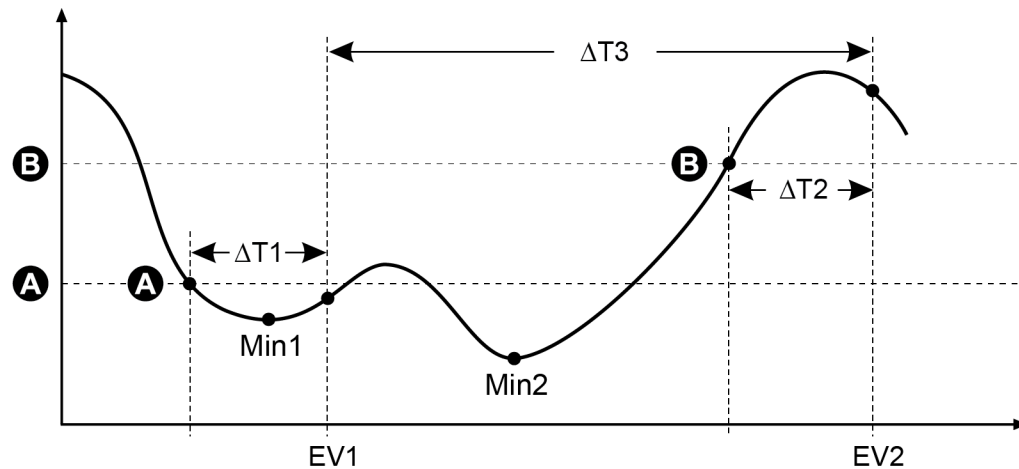

A	Pickup setpoint
B	Dropout setpoint
$\Delta T1$	Pickup time delay period (in seconds)
EV1	Start of alarm condition
$\Delta T2$	Dropout time delay (in seconds)
EV2	End of alarm condition
$\Delta T3$	Alarm duration (in seconds)

Min1	Minimum value recorded during pickup period
Min2	Minimum value recorded during alarm period

The meter records the date and time when the alarm event starts (EV1) and when it ends (EV2). The meter also performs any task assigned to the event, such as operating a digital output. The meter also records minimum values (Min1, Min2) before, during or after the alarm period.

Relative setpoint

The meter's Relative Setpoint modules behave similarly to the Setpoint modules, except the pickup and dropout levels are set relative to the *Nominal* input source.

See *ION Reference*, available from www.se.com, for more information on Relative Setpoint modules.

Sag/swell alarms

Your meter monitors your power system's voltage and current for sags and swells (INCITS (CBEMA) Type 2 and Type 3 disturbances).

When sag/swell limits are defined and alarming is enabled, the meter reports the disturbance's magnitude and duration, and logs data and waveform records associated with the disturbance.

You must configure nominal voltage and current for these alarms to function.

You can manually enter the limits (criteria) used by the meter to identify a sag or swell, or you can have your meter learn sag/swell limits by monitoring your power system.

See *ION Reference*, available from www.se.com, for more information on the Sag/Swell and Disturbance Analyzer modules.

Digital alarms

These alarms are triggered when the associated digital input changes state.

You can configure the alarm to be active when the digital input is on or off, depending on the alarm's purpose.

For example, if you used a digital input to monitor a breaker that is always supposed to be on, you would set the alarm to be active when the breaker has tripped.

NOTE: To stop a digital alarm from being displayed, set the alarm priority to **Info Only**. Disabling the digital alarm will disable all alarming functions of the associated digital input.

See *ION Reference*, available from www.se.com, for more information about the Digital Input module.

Alarm event priorities

Your meter's alarm priorities correspond to event priority ranges.

Alarm priority	Event priority
High (red)	192–255

Alarm priority	Event priority
Medium (yellow)	128–191
Low (blue)	64–127
Info Only (no alarm)*	1–63
None (no alarm or event)*	0

* Alarms with priority of **Info Only** or **None** are not indicated or displayed.

Info Only and None event priority

Alarms with a priority of **Info Only** or **None** are not shown on the meter's display, and do not function as alarms. If the alarm's priority is set to **Info Only**, and the event priority is greater than the event log cutoff value, the associated event is recorded in the meter's event log. If the alarm's priority is set to **None**, the event priority is automatically set to zero, and no associated event is logged in the meter's event log.

For events that you want to log for future reference or troubleshooting, but don't want alarm functions, set the alarm priority to **Info Only**.

For nuisance events that frequently occur, and you have no desire to log for reference or troubleshooting, set the alarm priority to **None**.

Alarm indicators

Your meter's display has an alarm indicator to show you what alarm levels have been detected (active or historic) and whether they have been acknowledged.

For active high priority alarms, the display will also flash until the alarm is acknowledged. There is also an alarm LED to indicate the meter's alarm condition.

Alarm	Alarm icon	Alarm icon flash	Alarm LED	Display
Active high	Red solid bell	Flash if not acknowledged	<ul style="list-style-type: none"> Flash if not acknowledged Steady if acknowledged 	Flash if not acknowledged
Active medium	Yellow solid bell	Flash if not acknowledged	<ul style="list-style-type: none"> Flash if not acknowledged Steady if acknowledged 	No flash
Active low	Blue solid bell	Flash if not acknowledged	<ul style="list-style-type: none"> Flash if not acknowledged Steady if acknowledged 	No flash

Alarm	Alarm icon	Alarm icon flash	Alarm LED	Display
Historic high	Red outline bell	Flash if not acknowledged	<ul style="list-style-type: none"> Flash if not acknowledged Steady if acknowledged 	No flash
Historic medium	Yellow outline bell	Flash if not acknowledged	<ul style="list-style-type: none"> Flash if not acknowledged Steady if acknowledged 	No flash
Historic low	Gray solid bell	No flash	Off	No flash
No active or unacknowledged alarms	Gray solid bell	No flash	Off	No flash

If there are multiple active alarms, the alarm condition associated with the highest priority is displayed. If there are multiple unacknowledged historic alarms, the meter displays the alarm condition associated with the highest priority unacknowledged historic alarm.

NOTE: To stop an alarm from being displayed without impacting other metering features, set the alarm priority to **Info Only**.

Default alarms

Your meter comes with default alarms. Some alarms are enabled by default.

NOTE: Some alarms require configuration to operate.

Name	Priority	Description	Default
Current Sag Ph1 - 3	High	Current sag alarms for phase 1, 2, 3	Disabled
Current Swell Ph1 - 3	High	Current swell alarms for phase 1, 2, 3	Disabled
Sag/Swell	High	Voltage sag/swell alarm	Disabled
Over I unbal	Medium	Over unbalanced current alarm	Disabled
Over V unbal	Medium	Over unbalanced voltage alarm	Disabled
Over THD V1 - 3	Medium	Over total harmonic distortion (THD) voltage alarms	Enabled
Over kW (P) sd	Medium	Over kW sliding demand alarm	Disabled
Over I a - c, (1 - 3) 4	Medium	Over current alarms	Disabled
V1 - V3 Setpoint	Medium	Voltage setpoint alarms	Disabled
Freq Setpoint	Medium	Frequency setpoint alarm	Enabled

Name	Priority	Description	Default
4-30 Volt Intrp Ph1 - 3	Low	4-30 voltage interruption power quality alarms	Enabled
Digital In	Info Only	Digital input alarms Number of alarms determined by the total number of available digital inputs Note: Info Only alarms are not displayed.	Enabled

Alarm information

You can view information about an alarm from your meter's display.

Only alarms with a priority of low, medium, or high are displayed.

Parameter	Description
Alarm	The name of the alarm (for example, Over THD V1).
Priority	Low, medium, or high alarm priority.
Date	The date and time the alarm was triggered.
Duration	The duration of the alarm (only applies to inactive alarms).
Ack	The date and time when the alarm was acknowledged (only applies to acknowledged alarms).
Value	Active alarm: The minimum or maximum value detected when the alarm was triggered. Historic alarm: The minimum or maximum value detected during the duration of the alarm.

Viewing and acknowledging alarms using the display

To view and acknowledge alarms using the display:

1. Press the **Home** button on the display.
2. Press **Alarms > Active Alarms** or **Historical Alarms**.
3. Press **Select**.
4. Press the up or down buttons to navigate alarms. A gray bar appears behind the active selection.

NOTE: You can press **Info** to display alarm details.

5. To acknowledge alarms press the up and down buttons simultaneously.

Alarm configuration

Topics in this section:

Alarm setup using the display

You can enable and disable alarms through the display.

WARNING

INACCURATE DATA RESULTS

- Do not use data displayed on the display or in software as a substitute for proper workplace practices or equipment maintenance.
- Confirm your alarm is properly configured.

Failure to follow these instructions can result in death, serious injury, or equipment damage.

Default alarms available on the display

Parameter*	Description
Over I unbal	Over unbalanced current alarm
Over THD V1	V1 over total harmonic distortion (THD) voltage alarm
Over THD V2	V2 over total harmonic distortion (THD) voltage alarm
Over THD V3	V3 over total harmonic distortion (THD) voltage alarm
Over kW sd	Over kW sliding demand alarm
Over Ia	Ia over current alarm
Over Ib	Ib over current alarm
Over Ic	Ic over current alarm
Over I4	I4 over current alarm
Over V unbal	Over unbalanced voltage alarm
V1 Setpoint	V1 setpoint alarm
V2 Setpoint	V2 setpoint alarm
V3 Setpoint	V3 setpoint alarm
Freq Setpoint	Frequency setpoint alarm
Sag/Swell 1	Voltage sag/swell alarm
Current Sag Ph1**	Current sag alarms for phase 1
Current Sag Ph2**	Current sag alarms for phase 2
Current Sag Ph3**	Current sag alarms for phase 3
4-30 Volt Intrp Ph1	4-30 voltage interruption power quality alarm for phase 1

Parameter*	Description
4-30 Volt Intrap Ph2	4-30 voltage interruption power quality alarm for phase 2
4-30 Volt Intrap Ph3	4-30 voltage interruption power quality alarm for phase 3
Current Swell Ph1**	Current swell alarms for phase 1
Current Swell Ph2**	Current swell alarms for phase 2
Current Swell Ph3**	Current swell alarms for phase 3

* Any Setpoint or Relative Setpoint module with an event priority greater than or equal to the Low alarm event priority is also displayed on this screen.

** Enabling or disabling one phase for each alarm type will enable or disable all phases for that type.

NOTE: Configuring alarms must be done using ION Setup.

Alarms with a priority less than **Low (Info Only or None)** are not displayed.

You must configure all the parameters related to the alarm for alarm functions to operate. For example, for the Over Ia alarm to operate, you must enter the nominal value and the conditions that define an alarm state, even if the alarm is shown as Enabled on the Alarm Setup screen.

Disabling and enabling alarms using the display

Disable alarms using the display when you are performing maintenance tasks on your system and want to prevent nuisance alarms.

NOTE: To stop an alarm from being displayed without impacting other metering features, set the alarm priority to **Info Only**.

To disable alarms using the display:

1. Press the **Home** button on the display.
2. Press **Setup Menu > Alarm Setup**.
3. Press **Select**.
4. Press **Edit**. Enter your meter's password, if prompted.
5. Press the up or down buttons to navigate alarms. A gray bar appears behind the active selection.
6. To select the item(s) press the up and down buttons simultaneously.
7. Press **Select** to accept the change.
8. Press **Select** to confirm.
9. Complete the system maintenance tasks.
10. Enable the alarms you disabled.

Configuring setpoint/standard alarms using ION Setup

To configure standard alarm settings using ION Setup:

1. Start ION Setup.
2. Open the **Setup Assistant** for your meter.
3. Click **Alarming > Standard**.
4. Select a setpoint and click **Edit**.
5. Enter the password and click **OK**, if required.

The **Setpoint Setup** screen is displayed.

6. Configure the setpoint values as required.
7. Click **Save** to save the settings to your meter.

Parameter	Value/Range	Description
By Percentage	By Percentage/By Value	When available, specifies if the Pickup and Dropoff entries are by percentage or by value. If the option is not available, pickup and dropoff entries are by value.
Disabled/Enabled	Checked/Unchecked	Forcing the alarm off disables all functions of the associated input. To stop an alarm from being displayed without affecting other meter features, set the alarm priority to Info Only.
Label	String value	When available, lets you modify the default label so it more clearly identifies the alarm. Letters, numbers, and underscores are permitted.
Pickup	Numeric value	Use this setting to provide a value for when the alarm turns on.
Pickup Delay	Numeric value	This specifies the number of seconds the input must be over the alarm pickup value before the alarm turns on.
Dropout	Numeric value	Use this setting to provide a value for when the alarm turns off.
Dropout Delay	Numeric value	This specifies the number of seconds the input must be below the alarm dropoff value before the alarm turns off.
Alarm Priority	None, Info Only, Low, Medium or High	Specifies the priority level of the standard alarm. When priority is set to Info Only, the alarm does not appear on the display.

Parameter	Value/Range	Description
Custom Priority	0–255	Select custom priority to view and configure the event priority of the event associated with the alarm. The event log cutoff value is displayed for reference; priorities above the cutoff are stored in the meter's event log.

Sag/swell overview

Your meter monitors your power system's voltage and current for sags and swells (INCITS (CBEMA) Type 2 and Type 3 disturbances).

When sag/swell limits are defined and alarming is enabled, the meter reports the disturbance's magnitude and duration, and logs data and waveform records associated with the disturbance.

You can manually enter the limits (criteria) used by the meter to identify a sag or swell, or you can have your meter learn sag/swell limits by monitoring your power system.

Configuring sag/swell alarms using ION Setup

To configure sag/swell alarm settings using ION Setup:

1. Start ION Setup.
2. Open the **Setup Assistant** for your meter.
3. Click **Alarming > Sag/Swell**.
4. Select the parameter you want to configure and click **Edit**.

The setup dialog box for that parameter appears.

5. Configure the parameters as required.

The values you need to set vary depending on the type of sag/swell alarm you are configuring.

Voltage sag/swell setup parameters

Parameter	Value/Range	Description
Enable/Disable	Enabled or Disabled	Specifies if sag/swell recording and alarming is enabled.
Nominal	1–999,999	Specifies the nominal voltage value used for sag/swell detection.
Swell Limit	Percentage of nominal	Specifies the swell limit expressed as a percentage of the nominal voltage.
Sag Limit	Percentage of nominal	Specifies the sag limit expressed as a percentage of the nominal voltage.

Parameter	Value/Range	Description
Hysteresis	Percentage – see description	Specifies the difference in magnitude between the sag or swell limit and the threshold for the power quality event to be considered over. For example, if the meter has the sag limit set to 90% of nominal and the hysteresis is set to 2%, this means that in a sag event, the voltage needs to return to 92% of nominal for the sag event to be considered over
Alarm priority	See description	Select the alarm priority you want to associate with Sag/Swell alarms. To stop an alarm from being displayed without affecting other meter features, set the alarm priority to Info Only.

Current sag/swell setup parameters

Parameter	Value/Range	Description
Enable/Disable	Enabled or Disabled	Specifies if sag/swell recording and alarming is enabled.
Nominal	1–999,999	Specifies the nominal current value used for current sag or current swell detection.
Pickup	Percentage of nominal	Specifies the percentage the current must deviate from the nominal current to be classified as a sag or a swell.
Dropout	Percentage of nominal	Specifies the percentage of nominal to which the current must recover to signal the end of the sag or the swell.
Hysteresis	N/A	Displays the difference in magnitude between the sag or swell Pickup and Dropout values. To change the hysteresis, change the Pickup or Dropout values.
Alarm priority	See description	Select the alarm priority you want to associate with Sag/Swell alarms. To stop an alarm from being displayed without affecting other meter features, set the alarm priority to Info Only .

Configuring digital input alarms using ION Setup

To configure digital alarm settings using ION Setup:

1. Start ION Setup.
2. Open the **Setup Assistant** for your meter.
3. Click **Alarming > Digital Input**.
4. Configure the digital input alarm settings by selecting an input and clicking **Edit**. Some settings are not configurable and are grayed out.
5. Click **Save** to save the changes to the meter.

Parameter	Value/Range	Description
Input	Input On/Input Off	Specifies the input state/alarm behavior: <ul style="list-style-type: none"> • Input On: the alarm is on when the digital input is on. • Input Off: the alarm is on when the digital input is off.
Disable/Enable	Checked/Unchecked	Disable or enable the associated alarm. To stop an alarm from being displayed without affecting digital input features, set the alarm priority to Info Only.
Label	String value	When available, lets you modify the default label so it more clearly identifies the alarm. Letters, numbers, and underscores are permitted.
Alarm Priority	None, Info Only, Low, Medium, or High	Specifies the priority level of the digital input alarm. To disable the alarm, set priority to Info Only.
Custom Priority	0–255	Select custom priority to view and configure the event priority of the event associated with the alarm. The event log cutoff value is displayed for reference; event priorities above the cutoff are stored in the meter's event log.

Alerts

An alert is an external notification from the meter to indicate changes, for example, a change of state for a digital input, or a power quality event such as a sag or swell.

When an alert condition occurs, a pulse or trigger is sent and generates the alert. You can configure alerts to send notification emails or messages to your energy management system through your meter's existing Ethernet communications connections. You can configure alert messages as a simple text string or you can also include device information. You can configure the alert's priority so that alerts are also recorded in the meter's event log.

You can configure multiple alerts on a single meter, each having different activation triggers, messages and/or transmission types. For instance, you can have two alerts, one generating an email, the other sending a message to your energy management system, but using the same trigger conditions; or you can have two alerts with different conditions that send two unique emails to two different email addresses. You can also generate alerts based on triggers from devices connected to your meter.

Creating alerts is an advanced feature that requires familiarity with ION architecture and your power system and communications network. To create an alert, you must configure the Alert module using a configuration tool. You must also configure your device's communications as needed to send the alerts, such as configuring your meter's SMTP settings and connecting it via Ethernet to an SMTP mail server in order to send an alert by email.

See the *ION Meter Alerts* technical note, available from www.se.com, for details.

Setpoint learning

Your meter can learn acceptable ranges or thresholds by monitoring normal operating values to determine what constitutes a voltage sag, or swell to help identify high and low setpoints.

NOTE: To help your meter learn the most accurate values possible, it is important that learning occur during a period of normal operation. Do not schedule learning during a period of unusual operations in your system. Do not modify your meter's configuration during the learning period as it may stop the learning process.

You can configure the meter so that learned values are applied automatically after the learning period is complete or require that they are reviewed and manually applied. If a learned value is invalid, the learned values are not automatically applied, but logged for review.

Setpoint learning can be used to identify the following values:

Feature	Values
Setpoints (Alarms)	High limit
	Low limit
	Sustain until ON
	Sustain until OFF
Sag	Voltage sag limit
Swell	Voltage swell limit

Learning installation mode and learning duration

You can configure learning for manual or automatic mode.

There are two learning installation modes:

1. **Manual:** The meter learns the applicable values but does not begin using the learned values. The learned values are recorded for review, and you can decide to use the learned values or adjust them as required before manually implementing the learned values.
2. **Automatic:** The meter learns the applicable values and begins using those learned values automatically at the end of the learning period. If a learned value is invalid, the meter does not apply the value, but the value is recorded in the event log.

You can configure the maximum learning duration. The actual learning duration may vary, depending on the stability of the system. If the system is stable for a period equal to one quarter of the maximum learning duration, learning is complete; otherwise, the learning period will be the maximum learning duration.

Example: Setpoint learning duration in a stable system

In this example, the learning duration is 30 days. When the system is stable for 7.5 days (one quarter of 30 days) learning is complete.

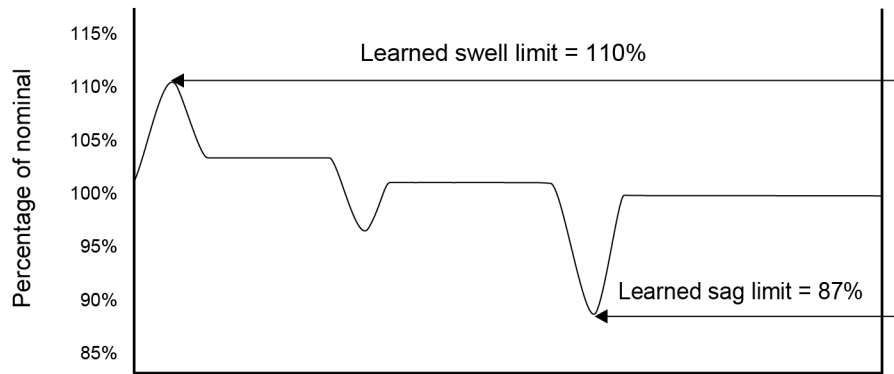

Maximum duration remaining	30	29	28	27	26	25	24	23	22	21	20	19	18	17	16	15	14	13	12	11	10	9	8	0
Stable learning time	0	0	0	1	2	3	4	0	0	1	2	3	4	5	0	0	1	2	3	4	5	6	7	7.5

Example: Setpoint learning duration in an unstable system

In this example, the learning duration is 30 days. Because the system is not stable for 7.5 days (one quarter of the 30 days) learning is complete at the end of the maximum learning duration.

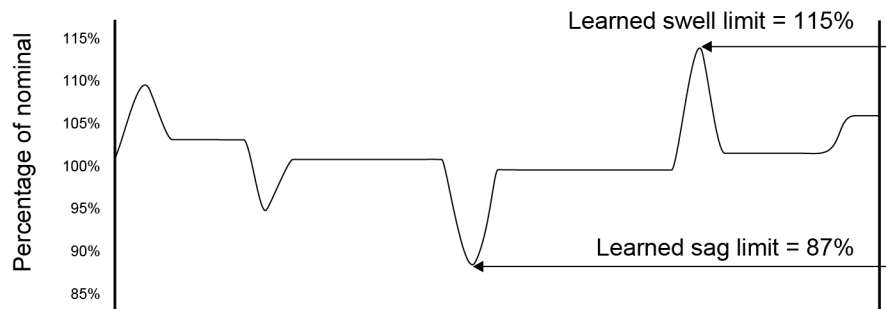

Maximum duration remaining	30	29	28	27	26	25	24	23	22	21	20	19	18	17	16	15	14	13	12	11	10	9	8	7	6	5	4	3	2	1	0
Stable learning time	0	0	0	1	2	3	0	0	1	2	3	4	5	6	0	0	1	2	3	4	5	6	7	0	0	1	2	4	5	0	1

See *ION Reference*, available from www.se.com, for more information on Sag/Swell, Setpoint and Relative Setpoint modules.

Implementing standard alarm setpoint learning using ION Setup

You can use ION Setup to implement setpoint learning, which analyzes your power system and recommends settings.

NOTE: To learn valid setpoint values the meter’s power system must be stable.

To implement setpoint alarm setpoint learning using ION Setup:

1. Start ION Setup.
2. Open the **Setup Assistant** for your meter.

- Click **Alarming > Standard**.

NOTE: You can manually configure setpoint values by selecting the setpoint and clicking **Edit**.

- Select a setpoint and click **Learn**.

The **Global Setpoint Learning** screen is displayed.

- Select the setpoint tabs to view existing configured or learned setpoint information.

- Click **Setup**.

The **Alarm Learning Setup** screen is displayed.

Setpoint learning parameters

Parameter	Value/Range	Description
Install mode	Automatic,	– Automatic: The learned values are automatically applied.
	Manual	– Manual: The learned values are stored for you to review and enter.
Duration	1–365	Days for maximum learning duration.

- Configure the learning parameters for each setpoint and click **Save**.
- Click **Start All** to begin setpoint learning for all setpoints. Click **Yes** to confirm or **No** to cancel.
 - Learning status and time remaining are indicated in the Learning Status box.
 - Click **Abort** to stop learning for a specific setpoint. To stop all setpoint learning, repeat for each setpoint tab.
- Apply the learned setpoint values:
 - Automatic:** The setpoint values are automatically applied unless the learning process has issues or the learned values are invalid.
 - Manual:** Navigate to **Alarming > Setpoints**, and then click **Learn**. On each setpoint tab, click **Install** to apply the learned values to that setpoint.

NOTE: If you click **Install** while learning is in progress (in either manual or automatic installation mode), it stops the learning process and prompts you for confirmation that you want to stop learning and install the learned values. Once you confirm, the learned values are automatically installed or prepared for manual installation.

Implementing sag and swell limit learning using ION Setup

You can use ION Setup to implement voltage sag/swell learning, which analyzes your power system and recommends settings.

NOTE: Your meter's power system must be stable to learn valid sag/swell limits.

NOTE: Learning is not supported for **Current Swell** and **Current Sag**.

To implement sag/swell limit learning using ION Setup:

1. Start ION Setup.
2. Open the **Setup Assistant** for your meter.
3. Click **Alarming > Sag/Swell**.
4. Select **Voltage** and click **Learn**.

NOTE: You can manually configure the limit values by selecting the parameter and clicking **Edit**.

The **Global Setpoint Learning** screen is displayed.

5. Click **Setup**.

The **Alarm Learning Setup** screen is displayed.

Sag/swell limit learning parameters

Parameter	Value/Range	Description
Install mode	Automatic, Manual	<ul style="list-style-type: none"> – Automatic: the learned values are automatically applied. – Manual: the learned values are stored for you to review and enter.
Duration	1–365	Days for maximum learning duration.

6. Configure the sag/swell limit learning parameters and click **Save**.
7. Click **Start** to begin sag/swell limit learning.
 - Learning status and time remaining are indicated in the Learning Status box.
 - Click **Abort** to stop sag/swell limit learning.
8. Apply the learned sag/swell limits.
 - Automatic: the limits are automatically applied unless there are issues with the learning process.
 - Manual: navigate to **Alarming > Sag/Swell**. Select **Voltage** and click **Learn**. Click **Install** to apply the learned limits.

NOTE: If you click **Install** while learning is in progress (in either manual or automatic installation mode), it stops the learning process and prompts you for confirmation that you want to stop learning and install the learned limits. Once you have confirmed, the learned limits are automatically installed or prepared for manual installation.

Power quality

Your meter measures voltage and current harmonics, and calculates several harmonic distortion values, including K-factor and crest factor.

Configure your meter with the power system's nominal values for voltage, current, and frequency for the meter to perform power quality calculations.

Power quality configuration

Use ION Setup to configure sag/swell and advanced power quality logging.

NOTE: For waveform recording to trigger automatically, enter your system's nominal (normal) voltage and current values and the amount of deviation from the nominal that is considered a sag or a swell using the **Metering > Basic** or **Alarming** screen

NOTE: Changing your meter's data logging (including burst data logging) and waveform recording configuration clears your meter's existing data logs, waveform records and COMTRADE waveform files.

Before setting up the Power Quality (PQ) parameters, make sure the meter is configured correctly:

- Metering parameters such as volts mode and PT/CT ratios
- Time sync settings, for integrating the meter in an energy management system such as EcoStruxure™ Power Monitoring Expert
- Nominal system parameters (nominal volts, nominal current and nominal frequency), for detecting power quality events
- Amount of deviation from the nominal that is considered a sag or swell

Make sure you understand:

- The structure of the meter's logging framework
- The meter's existing logging configuration
- Your data logging requirements

Changing the meter's data recorder and waveform recorder configuration clears existing data and waveforms in those recorders.

NOTICE

DATA LOSS

Ensure that all important data and waveforms have been recorded before configuring the data and waveform recorders.

Failure to follow these instructions can result in data loss.

Power quality logging

Sags and swells

Your meter monitors your power system's voltage and current for sags and swells (INCITS (CBEMA) Type 2 and Type 3 disturbances).

When sag/swell limits are defined and alarming is enabled, the meter reports the disturbance's magnitude and duration, and logs data and waveform records associated with the disturbance.

Configuring sag and swell logging

Use ION Setup to configure your meter to log data and waveform records related to sag/swell events, and to export the waveform data to COMTRADE files.

NOTE: There are two data recorders for logging sag/swell related data: Sag/Swell Log (Data Rec 5) records data for plotting the ITI (CBEMA) curve, and Sg/Sw HS Log (Data Rec 6) records voltage and current data from the High-Speed Power Meter module.

To configure the Sag/Swell Log, Sg/Sw HS Log, Sag/Swell Waveform Log and Sag/Swell COMTRADE files:

1. Start ION Setup.
2. Open the **Setup Assistant** for your meter.
3. Click **Power Quality > Sag/Swell Logging**.
4. Select the data log and click **Edit**. Enter the meter password if prompted.
The **Sag/Swell Logging Wizard** appears.
5. The **Device setting verification** screen displays results of the meter configuration check for potential errors related to sag/swell monitoring and reporting. Click **Fix** to view details or click **Next** to ignore the results and proceed to the next screen.
6. The **Disturbance Logging Setup** screen displays the **Log Depth** setting for Sag/Swell Log (Data Rec 5). You can change the maximum number of records to store in this log. Click **Next** to proceed to the next screen.
7. The **High Speed Recording** screen displays the settings for the high-speed Sag/Swell data recorder (Sg/Sw HS Log - Data Rec 6). You can configure these settings for the meter to perform burst data logging.

Parameter	Description
Enable Burst Data Logging	Select or clear this check box to turn burst data logging on or off.

Parameter	Description
Pre-trigger recording ¹	Specifies, in seconds, how many pre-event records to capture. The actual number of records set in the high-speed Sag/Swell data recorder's <i>Pre-trigger Records</i> setup register = (2 x system frequency) x (number of seconds).
Post-trigger recording ²	Specifies, in seconds, how many post-event records to capture. The actual number of records set in the high-speed Sag/Swell data recorder's <i>Post-trigger Records</i> = (2 x system frequency) x (number of seconds).
Total # of recordings ³	Specifies how many burst data log sets to save in long-term memory (NVRAM). The actual number of records is configured in the high-speed Sag/Swell data recorder's <i>Depth</i> setup register = (Total # of recordings) x (<i>Pre-trigger Records</i> + <i>Post-trigger Records</i> + 1). See " Data recorder burst data " for an example of how a data log set is calculated.

8. Click **Next**.
9. The **Waveform Log Setup** screen allows you to configure the waveform recorder for Standard or Delayed waveform capture.

NOTE: The **Sag/Swell Logging Wizard** does not support Extended waveform capture. See "[Waveform capture](#)" for details on Standard, Delayed and Extended waveform capture.

Parameter	Description
Waveform Depth	Specifies the maximum number of waveform records stored on the meter.
Waveform Format	Specifies the number of samples per cycle and the number of cycles that are stored in a waveform record.
Trigger Position	Specifies the number of cycles to capture before the waveform versus after the waveform. Trigger position can be set using the pre-cycle arrows or the slider bar.

¹If system frequency is changed, the recording duration for Pre-trigger recording and Post-trigger recording automatically adjusts to reflect the new frequency setting.

²If system frequency is changed, the recording duration for Pre-trigger recording and Post-trigger recording automatically adjusts to reflect the new frequency setting.

³When burst data logging is enabled, the equivalent number of records for 2 burst data log sets is allocated in short-term memory (RAM). The actual number of records set in the high-speed Sag/Swell data recorder's *Buffer Depth* setup register = 2 x (*Pre-trigger Records* + *Post-trigger Records* + 1).

NOTE: The maximum number of cycles (pre-event + post-event) cannot exceed the total number of cycles in the waveform format.

10. Click **Next**.
11. Configure your meter's COMTRADE settings:
 - a. Select or clear the **Generate COMTRADE files** check box to enable or disable the creation of COMTRADE records.

NOTE: The waveform viewer on your meter's webpages uses the meter's COMTRADE files. If you want to view waveforms on the meter's webpages, select **Generate COMTRADE files**.

NOTE: The factory-default configuration for COMTRADE only supports Standard waveform capture.

- b. Set the **Log depth** for the COMTRADE files to specify the maximum number of records stored on your meter's SFTP site.
12. Click **Finish**.

You are returned to the Sag/Swell Logging screen and the entry shows your new configuration.

If nothing happens when you click **Finish**, check the log depths and buffer depths for all your other data logs to make sure that the meter has enough memory for these changes. Adjust the log depth and buffer depth of the data and waveform recorders if needed.

Configuring Advanced Power Quality

Use to configure your meter's power quality (PQ) monitoring and logging settings for IEC 61000-4-30, EN 50160, and IEEE 519.

The meter's PQ frameworks are designed with logical dependencies. IEC 61000-4-30 must be enabled first if you want to monitor and record PQ parameters for EN 50160 or IEEE 519.

NOTICE

DATA LOSS

- Enable IEC 61000-4-30 before enabling other power quality monitoring and recording features.
- Enable Sag/Swell before configuring power quality disturbance related features.

Failure to follow these instructions can result in data loss.

To configure Advanced Power Quality:

1. Start ION Setup.
2. Open the **Setup Assistant** for your meter.
3. Click **Power Quality > Advanced PQ**.

4. Select **4-30 Enable** and click **Edit** to configure your meter's IEC 61000-4-30 logging parameters.
5. Configure the settings as required:

IEC 61000-4-30 Setup

Parameter	Description
Enabled	Select if you want to enable IEC 61000-4-30 monitoring. NOTE: This option must be enabled when monitoring EN 50160 or IEEE 519 parameters.
Threshold	Specifies the percentage of nominal voltage that defines a disturbance. For example, if you set this to 10% of 120 V nominal, the disturbance occurs when the voltage dips to 12 V and below.
Hysteresis	Specifies the percentage above the Threshold that defines the end of the disturbance. For example, if you set this to 2%, the end of the disturbance occurs when the voltage rises to (10% + 2%) of nominal, or 14.4 V and above.
Log 4-30 3s measurements	Select if you want to enable IEC 61000-4-30 3-second interval data logging.
Log 4-30 10s measurements	Select if you want to enable IEC 61000-4-30 10-second interval data logging.

6. Click **Send** to save your changes.

The **Advanced PQ Logging** screen shows the new configuration.

7. Select **EN50160 Enable**.

If you want to delete all logged EN 50160 data, click **Reset**, then click **Yes** to confirm.

8. Click **Edit** to configure your meter's EN 50160 logging parameters.

NOTE: You must enable IEC 61000-4-30 before the meter can start monitoring EN 50160 parameters.

9. Configure the settings as required:

EN50160 Configuration Setup

Parameter	Description
Enabled	Select if you want to enable EN 50160 monitoring.
Nominal Voltage	Specifies the nominal voltage value used for EN 50160.
Nominal Frequency	Specifies the nominal frequency used for EN 50160.
Log EN50160 measurements	Select if you want to log EN 50160 parameters. Note: You need to enable EN 50160 monitoring to log the parameters.

10. Click **Send** to save your changes.

The **Advanced PQ Logging** screen shows the new configuration.

11. Select **519 Enable** and click **Edit** to configure your meter's IEEE 519 logging parameters.

NOTE: You must enable IEC 61000-4-30 before the meter can start monitoring IEEE 519 parameters.

12. Configure the settings as required:

IEEE 519 Configuration

Parameter	Description
Nominal Voltage	Displays the nominal voltage value used for IEEE 519. Note: If you change the Nominal Voltage, you must return to this setup screen and manually update the IEEE 519 configuration.
<Bus voltage options>	Select the bus voltage at the point of common coupling. Select Disabled if you do not want to log IEEE 519 related data.

13. After specifying the bus voltage, click **Next** to configure the IEEE 519 current parameters.

IEEE 519 Configuration

Parameter	Description
Maximum short circuit current	Enter the maximum short-circuit current at the point of common coupling.
Maximum demand load current	Enter the maximum demand load current at the point of common coupling.
Ratio	This displays the maximum short-circuit to maximum demand load ratio. This is used to determine the voltage and current distortion limits.

14. Click **Next** to view the screen that displays the voltage and current distortion limits for the harmonic content.

Harmonics 2 to 50 and THD/TDD are displayed, with the corresponding set limits for Voltage Distortion % and Current Distortion %.

15. Click **Finish** to save your changes.

The **Advanced PQ Logging** screen shows the new configuration.

Harmonics

Harmonics are integer multiples of the fundamental frequency of the power system.

Harmonics information is valuable for power quality analysis, determining properly rated transformers, maintenance, and troubleshooting. Evaluation of harmonics is required for compliance with system power quality standards such as EN 50160 and meter power quality standards such as IEC 61000-4-30.

Harmonics measurements include per-phase magnitudes and angles (relative to the fundamental frequency of the phase A voltage) for the fundamental and higher order harmonics relative to the fundamental frequency. The meter's power system setting defines which phases are present and determines how line-to-line or line-to-neutral voltage harmonics and current harmonics are calculated.

Harmonics are used to identify whether the supplied system power meets required power quality standards, or if non-linear loads are affecting your power system. Power system harmonics can cause current flow on the neutral conductor, and damage to equipment such as increased heating in electric motors. Power conditioners or harmonic filters can be used to minimize unwanted harmonics.

Viewing harmonics information using the display

To view detailed harmonics data through the display:

1. Press the Home button on the display.
2. Press **Power Quality > Harmonics**. The total harmonic distortion (THD) screens are displayed.
3. Press the **More** button, then use the up or down buttons to select the desired harmonics. The per-phase harmonics are graphically displayed.
4. Press the left and right buttons to move to individual harmonics. The harmonic number, magnitude and phase angle are displayed.

Voltage crest factor

Crest factor is the ratio of peak to RMS voltage values.

For a pure sinusoidal waveform, crest factor is equal to 1.414. The meter uses the following equation to calculate crest factor:

$$C = \frac{V_{\text{peak}}}{V_{\text{RMS}}}$$

C = Crest factor
 V_{peak} = Voltage peak
 V_{RMS} = Voltage RMS

Current crest factor

Crest factor is the ratio of peak to RMS current values.

For a pure sinusoidal waveform, crest factor is equal to 1.414. The meter uses the following equation to calculate crest factor:

$$C = \frac{I_{\text{peak}}}{I_{\text{RMS}}}$$

C = Crest factor
 I_{peak} = Current peak
 I_{RMS} = Current RMS

K-factor

K-factor relates the heating effect of a distorted current in a transformer to a sinusoidal current with the same RMS magnitude — it describes a transformer's ability to serve non-linear loads without exceeding rated temperature rise limits.

The K-factor is equal to the sum of the squares of the harmonic currents multiplied by the squares of the harmonic order. The meter uses the following equation to calculate K-factor:

$$K = \frac{\sum_{n=1}^h (I_n^2 \times h^2)}{\sum_{n=1}^h I_n^2}$$

Where K is the K-factor, h is the harmonic order and I_h is the true RMS current of harmonic order h .

Harmonic content calculations

Harmonic content (H_C) is equal to the RMS value of all the non-fundamental harmonic components in one phase of the power system.

The meter uses the following equation to calculate H_C :

$$H_C = \sqrt{(H_2)^2 + (H_3)^2 + (H_4)^2 \dots}$$

THD% calculations

THD% is a quick measure of the total distortion present in a waveform and is the ratio of harmonic content (H_C) to the fundamental harmonic (H_1).

By default, the meter uses the following equation to calculate THD%:

$$THD = \frac{H_C}{H_1} \times 100\%$$

thd and TDD

Your meter can be configured to provide thd (total harmonic distortion using the total RMS value for the content rather than the fundamental content) and TDD (total demand distortion, the harmonic current distortion against the maximum demand of the electrical system).

$$thd = H_C / RMS * 100\%$$

$$TDD = H_C / Demand_{Max} * 100\%$$

See *ION Reference*, available from www.se.com, for details about the Harmonics Measurement module.

Phasors

Phasors are used to represent the voltage and current magnitude and angles.

The length of the lines in the phasor diagram represent the relative magnitude of the voltages with respect to the other phase voltages, and the currents with respect to the other phase currents. All angles are measured with respect to the V_a/V_1 phase. The V_a/V_1 phasor is fixed to the right-hand horizontal axis (positive x-axis). Positive angles are measured counterclockwise.

Measured values are provided for the magnitude and relative angle for each voltage and current phase.

Delta vector diagrams can be configured to display two different ways:

- Instrument (voltage vectors appear 60 degrees apart - showing the actual voltage and current values that the meter is measuring).
- System (voltage vectors appear 120 degrees apart - showing true system operation including any calculated values).

Phasor information can be used to troubleshoot incorrect connections on the meter's voltage and current inputs (for example, switched phase wiring or polarity errors), if you know how the phasors should be oriented for your power system.

Phasor information can be viewed using ION Setup, meter webpages, or the display.

Power quality standards compliance

Your meter is compliant with the following power quality standards.

IEC 61000-4-30

IEC 61000-4-30 power quality standard compliance is provided by ION modules including: Power Quality Aggregator, Harmonics Measurement, Disturbance Analyzer, Symmetrical Components, and Sag/Swell.

See the *IEC 61000-4-30 compliance and ION meters* technical note, available from www.se.com, for details.

EN 50160

The EN 50160 framework includes ION modules, such as: Harmonics Evaluation and Voltage Harmonics.

Your meter's framework is pre-configured for a low voltage system.

NOTE: Connect your meter to a UPS to avoid losing EN 50160 data in the event of a power outage.

See the *Power Quality: ION Meters and EN50160* technical note, available from www.se.com, for details.

IEEE 519

The IEEE 519 framework includes ION modules, such as: Harmonics Evaluation, Harmonics Measurement and Counter.

IEC 60255-24 (COMTRADE)

The meter provides waveforms in **COM**mon format for **TRAN**sient **DATA** Exchange (COMTRADE) format. COMTRADE records are generated from the existing Waveform Recorder modules that are connected to the COMTRADE module.

See the *COMTRADE and ION technology* technical note, available from www.se.com, for details.

Disturbance direction detection overview

Your meter has disturbance direction detection capabilities to help you determine the location of a power system disturbance.

When a disturbance occurs, the meter analyzes the disturbance information to determine the direction of the disturbance relative to the meter. This analysis includes a confidence level indicating the level of certainty that the disturbance is in the determined direction and is stored in your meter's event log.

Disturbance direction detection is enabled on your meter by default and does not require any additional configuration beyond setting the nominal voltage and nominal frequency.

Disturbance direction detection can help locate the source of a disturbance when used in a system of disturbance direction detection devices. In the diagram below, meters (B), (C) and (D) are installed on the power consumer side, while meter (E) is installed on the utility side.

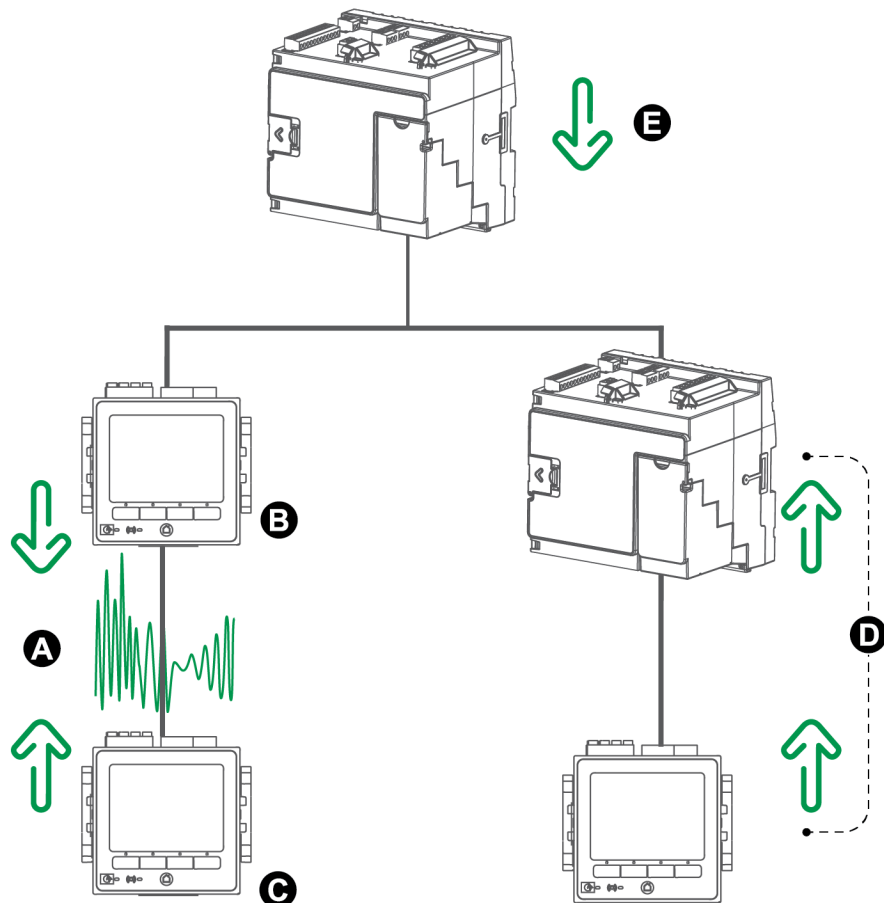

A	Disturbance location
B	Meter (B) reports downstream disturbance
C	Meter (C) reports upstream disturbance
D	Meters (D) report upstream disturbance
E	Meter (E) reports downstream disturbance

The arrows show the direction the meters have determined for the disturbance. With this information, you can determine that the disturbance occurred between meter (B) and meter (C) and can focus on that section of your system to find the cause of the disturbance.

Disturbance direction detection events

The results of the disturbance direction detection algorithm appear in the meter's event log.

The image below shows an example of how the Disturbance Direction Detection event appears in your meter's event log when viewed using ION Setup.

NOTE: You can view your meter's event log through ION Setup, the meter webpages or display.

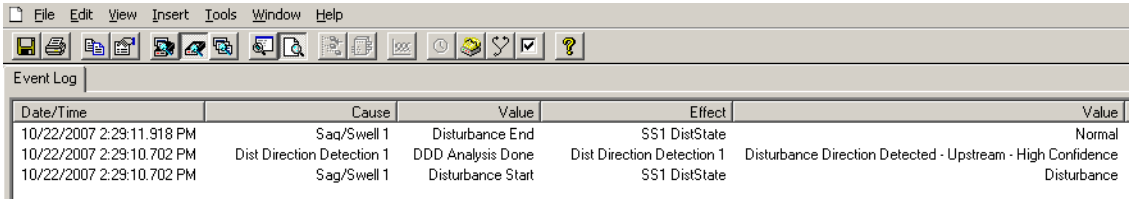

Date/Time	Cause	Value	Effect	Value
10/22/2007 2:29:11.918 PM	Sag/Swell 1	Disturbance End	SS1 DistState	Normal
10/22/2007 2:29:10.702 PM	Dist Direction Detection 1	DDD Analysis Done	Dist Direction Detection 1	Disturbance Direction Detected - Upstream - High Confidence
10/22/2007 2:29:10.702 PM	Sag/Swell 1	Disturbance Start	SS1 DistState	Disturbance

See *ION Reference*, available from www.se.com, for more information about the Disturbance Direction Detection module.

COMTRADE

Your meter can generate COMTRADE files and store them on the meter's internal SFTP site.

COMTRADE stands for COMMon format for TRAnsient Data Exchange defined by IEC 60255-24, and defines a common format for power quality event (disturbance) data in order to simplify retrieval, analysis and exchange of disturbance data between multiple sources and vendors.

The format of your meter's COMTRADE files is as defined by IEC 60255-24.

COMTRADE can be used in conjunction with IEC 61850.

See the *COMTRADE and ION technology* technical note, available from www.se.com, for details.

COMTRADE implementation

COMTRADE is configured as part of the default waveform recording framework.

COMTRADE records are generated for sag/swell events. Configure your meter nominal voltages to enable waveform recording. COMTRADE records are stored as read-only files on your meter's internal SFTP site, and are deleted when you perform a Master reset of the meter, upgrade firmware or make changes to the waveform recorders.

By default:

- The meter is configured so COMTRADE records are generated for the default waveform recorders.

NOTE: If you add additional waveform recorders and you want COMTRADE files generated for these new recorders, you need to configure a new COMTRADE module using ION Setup Advanced mode. You can configure up to three COMTRADE modules.

- The oldest COMTRADE record is overwritten by the newest record when the COMTRADE depth is exceeded.

NOTE: COMTRADE files can only be downloaded using an Ethernet connection. They cannot be downloaded using serial, modem or Ethernet gateway connections.

See the *COMTRADE and ION technology* technical note, available from www.se.com, for details.

Waveforms on the meter webpages

You can use the waveform viewer on the meter's webpages to view waveforms generated as a result of power quality events.

Set up the meter to view waveforms on the webpages

Before you can view waveforms on the meter's webpages, you need to perform some basic configuration to enable waveform capture and store the waveforms in COMTRADE format.

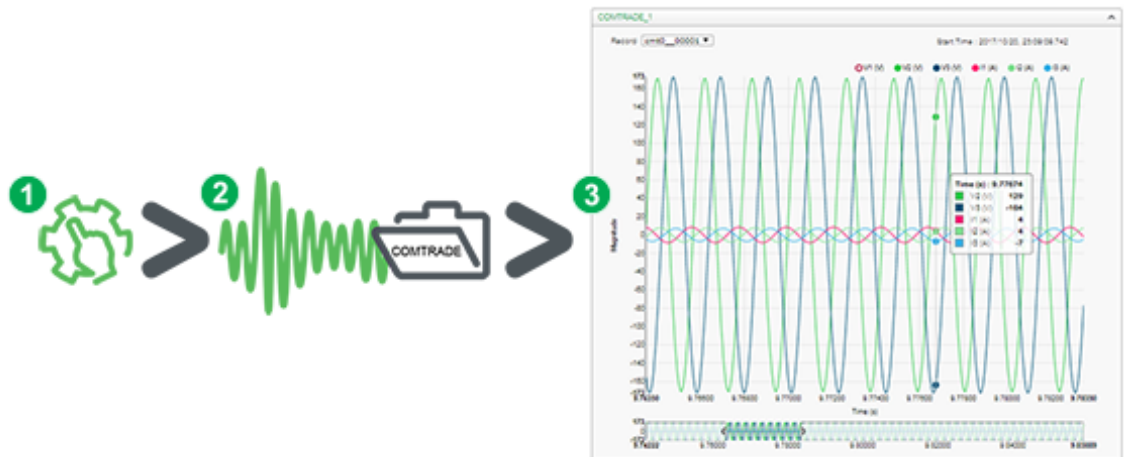

1. Enable waveform capture on your meter

Set the meter's nominal voltage using ION Setup or meter webpages.

2. A waveform is captured when a power quality event occurs

A COMTRADE record is generated and saved to your meter's internal SFTP site.

3. View the waveform on the meter's webpages

Go to the waveform viewer (Monitoring > Waveforms) to explore the waveform data.

The waveform viewer uses the meter's COMTRADE files to display the waveforms. If the events you want to capture are not included in the default framework, you can customize the meter's waveform recording framework.

Webpage waveform viewer

After COMTRADE files are generated by your meter, you can view them using the waveform viewer.

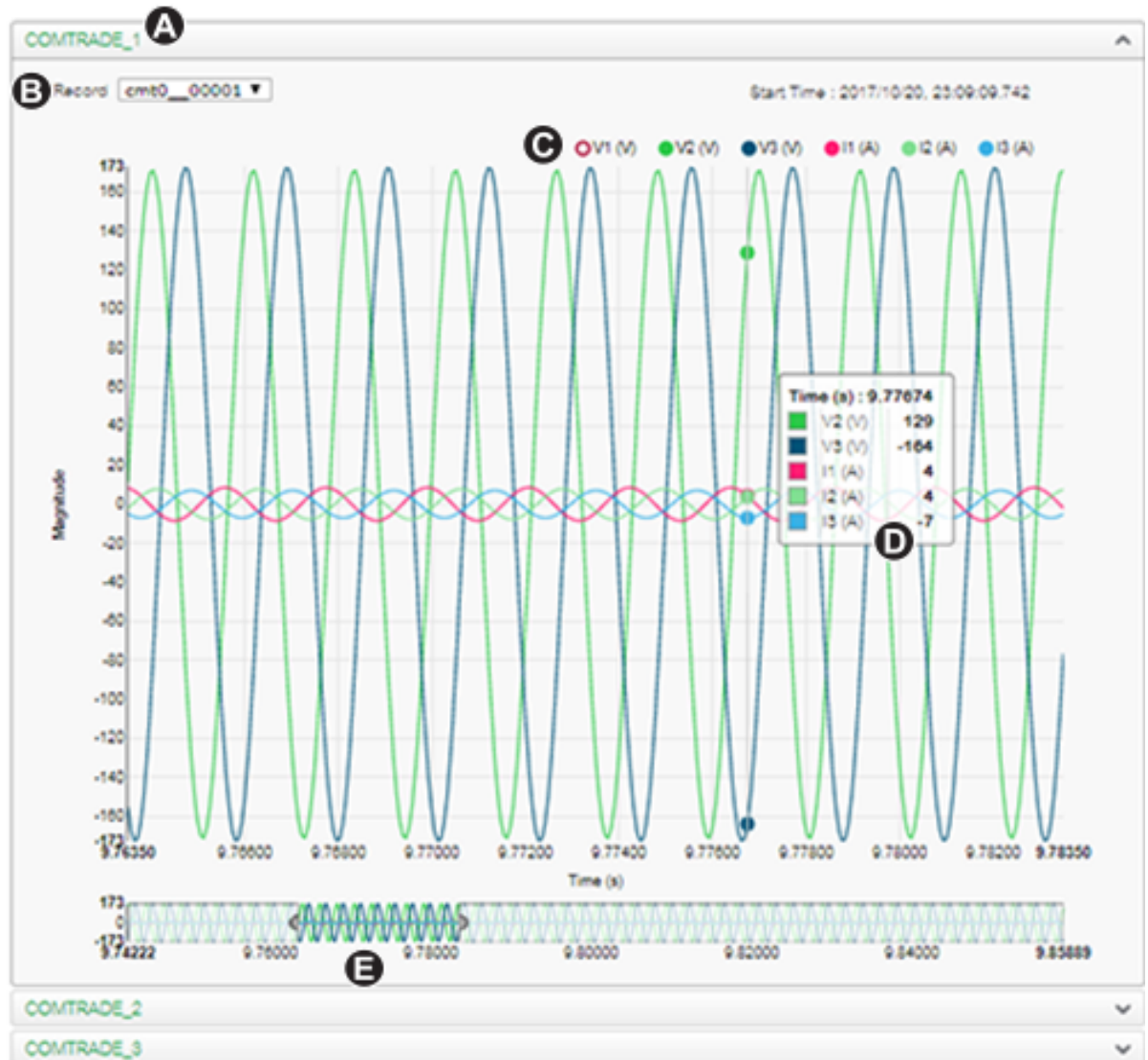

A	Select the COMTRADE module to view (COMTRADE_1 is set up by default; you can also set up COMTRADE_2 or COMTRADE_3)
B	Select the particular COMTRADE waveform to view
C	Show/hide parameters
D	View details
E	Zoom in/out

Viewing waveforms on meter webpages

Use the waveform viewer on your meter's webpages to view the meter's COMTRADE waveform files.

Prerequisites:

Ensure the meter is configured to record waveforms by setting the nominal voltage.

To view waveforms on meter webpages:

1. Open a browser and go to the IP address for your meter, entering valid login credentials when requested.
2. Navigate to **Monitoring > Waveforms**.

A screen displays with accordion menus for three COMTRADE modules (regardless of whether or not that COMTRADE module is being created by the meter). The waveform viewer for COMTRADE_1 is expanded.

By default, COMTRADE_1 displays the sag/swell waveform records. COMTRADE_2 and COMTRADE_3 are used if you have configured additional waveform recorders and connected them to COMTRADE modules.

3. Select the accordion menu for the COMTRADE records you want to view, for example COMTRADE_2.

The waveform viewer for those COMTRADE records is displayed.

4. Select the file you want to view from the record drop-down list box.

The numbering starts at 0 (zero), which means you select cmt0_00004 to view the fifth file for COMTRADE_1.

5. Click or tap an individual voltage or current channel in the legend to show or hide it in the waveform viewer.

- Visible
- Hidden

6. Use the bar at the bottom to zoom in/zoom out on a particular section of the waveform, or to scan through the waveform with the selected zoom level.

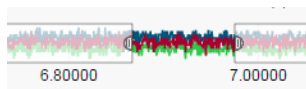

- Draw a window over a particular area to zoom in on that section of the waveform.
- Drag the selected area to move the zoom across the waveform.
- Drag the start and end points to expand or narrow the zoom.

7. Hover over or tap a spot on the waveform to view the values associated with that particular moment in time.

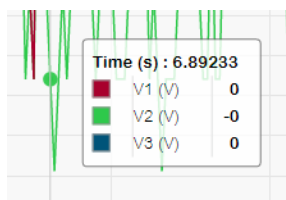

Burst data logging

Burst data logging is a recording method that captures a snapshot of data that occurred immediately before and immediately after a triggered recording.

Burst data logging is analogous to continuous shooting mode or “burst mode” in photography. An understanding of pre and post event data assists in the analysis of undesired power quality events such as sags or swells.

Burst logging is typically used for high-speed RMS (half-cycle) data capture, but the data recorder supports standard speed (1-second) recording as well, depending on the ION modules connected to the inputs of the Data Recorder module.

NOTE: To maximize the performance of your power management system, it is recommended that devices be connected directly to an Ethernet network.

Data recorder burst data

The meter’s Data Recorder modules support burst data logging.

The Data Recorder module’s *Pre-trigger Records* setup register specifies how many pre-event records are saved with each triggered recording. The *Post-trigger Records* setup register specifies how many post-event records are saved with each triggered recording.

Both *Pre-trigger Records* and *Post-trigger Records* are set to zero by default. To configure the data recorder for burst data logging, either or both of these setup registers must be set to a non-zero positive integer value.

The data log set for each triggered recording is equal to the sum of *Pre-trigger Records* + *Post-trigger Records* + 1 (where 1 is the actual record when the Data Recorder module’s *Record* input was triggered).

For example, if *Pre-trigger Records* is set to 10 and *Post-trigger Records* is set to 5, the number of records for each data log set is 16:

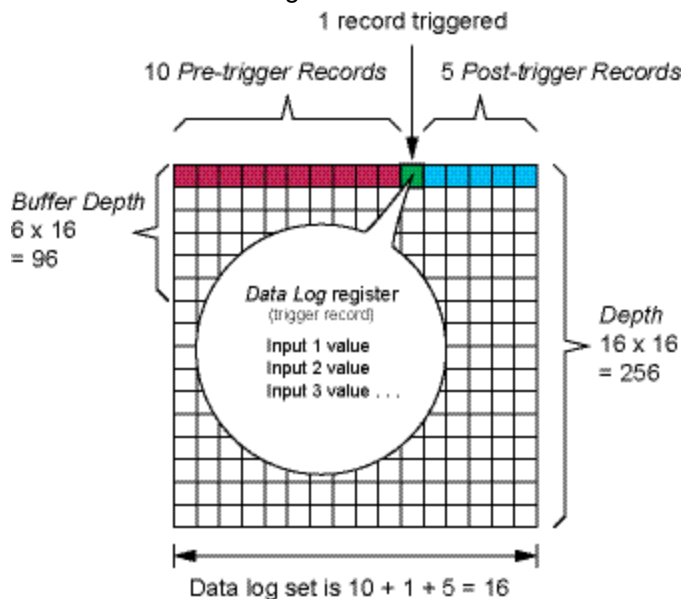

Burst data log set = [pre-trigger records] + [post-trigger records] + [actual trigger record] = 10 + 5 + 1 = 16.

When burst data logging is enabled, both *Buffer Depth* and *Depth* setup registers must be set to a positive integer multiple of the data log set.

Use the system frequency to calculate the number of records needed to capture 1 second of data:

- For 60 Hz, total number of records per second = 60 cycles/second x 2 half-cycles = 120
- For 50 Hz, total number of records per second = 50 cycles/second x 2 half-cycles = 100

You can use the **Power Quality** setup assistant in ION Setup to specify how many seconds of pre-trigger and post-trigger data you want to capture. ION Setup automatically calculates the required number of records based on your input.

Waveform capture

The meter's Waveform Recorder modules capture waveform data.

The Waveform Recorder module captures one waveform record every time its *Record* input is triggered.

A waveform record is defined by the module's *Format* setup register, expressed as (number of samples per cycle) x (number of cycles per waveform record). For example, if *Format* is set to 256x7, that means one waveform record is made up of 7 cycles of waveform data at 256 samples per cycle resolution.

The meter supports 3 waveform capture types: standard, delayed, and extended.

Standard waveform capture

The meter's Waveform Recorder modules support standard waveform capture.

A standard waveform capture saves one buffered waveform record at the *Record* trigger time. Only pre-trigger waveform data is captured in this mode. No post-trigger waveform cycles are recorded.

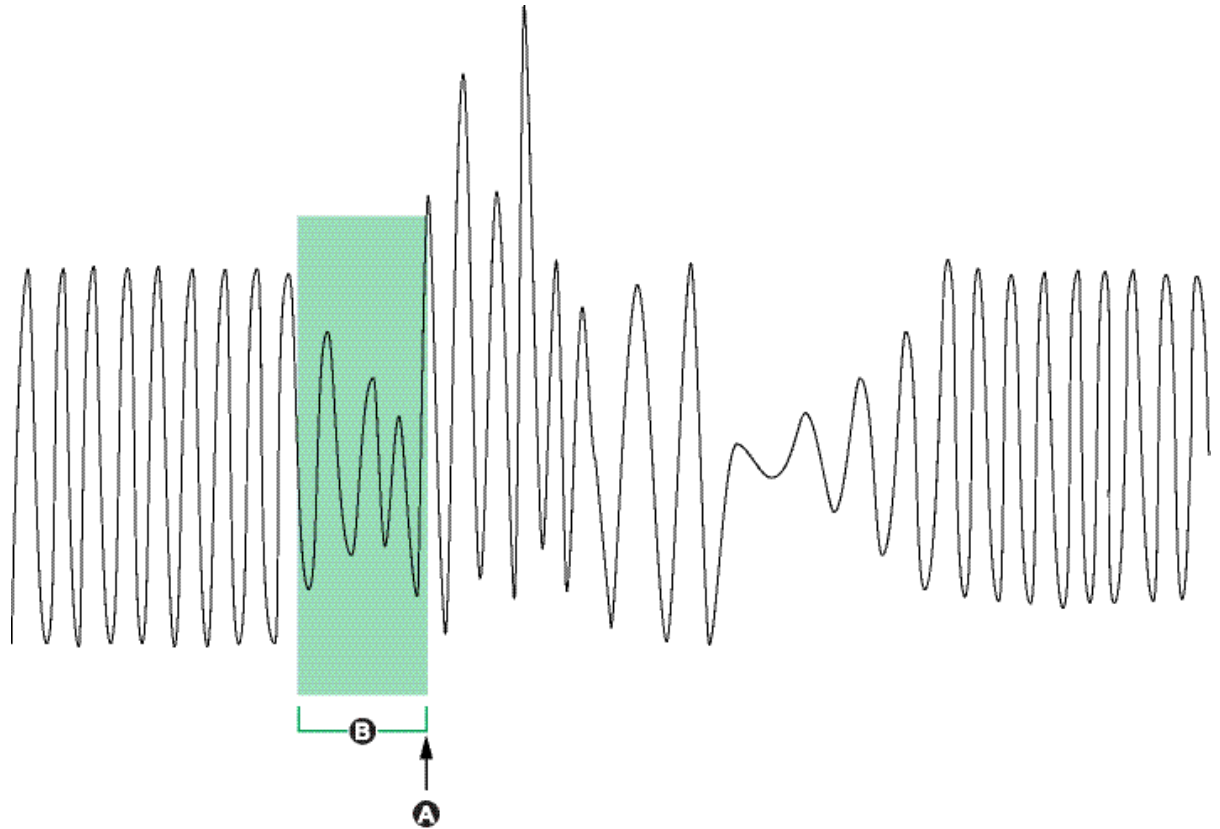

A	Waveform recording triggered
B	Waveform record captured at trigger

Delayed waveform capture

The meter's Waveform Recorder modules support delayed waveform capture.

The Waveform Recorder module's *Record Delay Cycles* setup register specifies how many cycles to delay the waveform capture after the *Record* input is triggered. This is for capturing post-trigger waveform data.

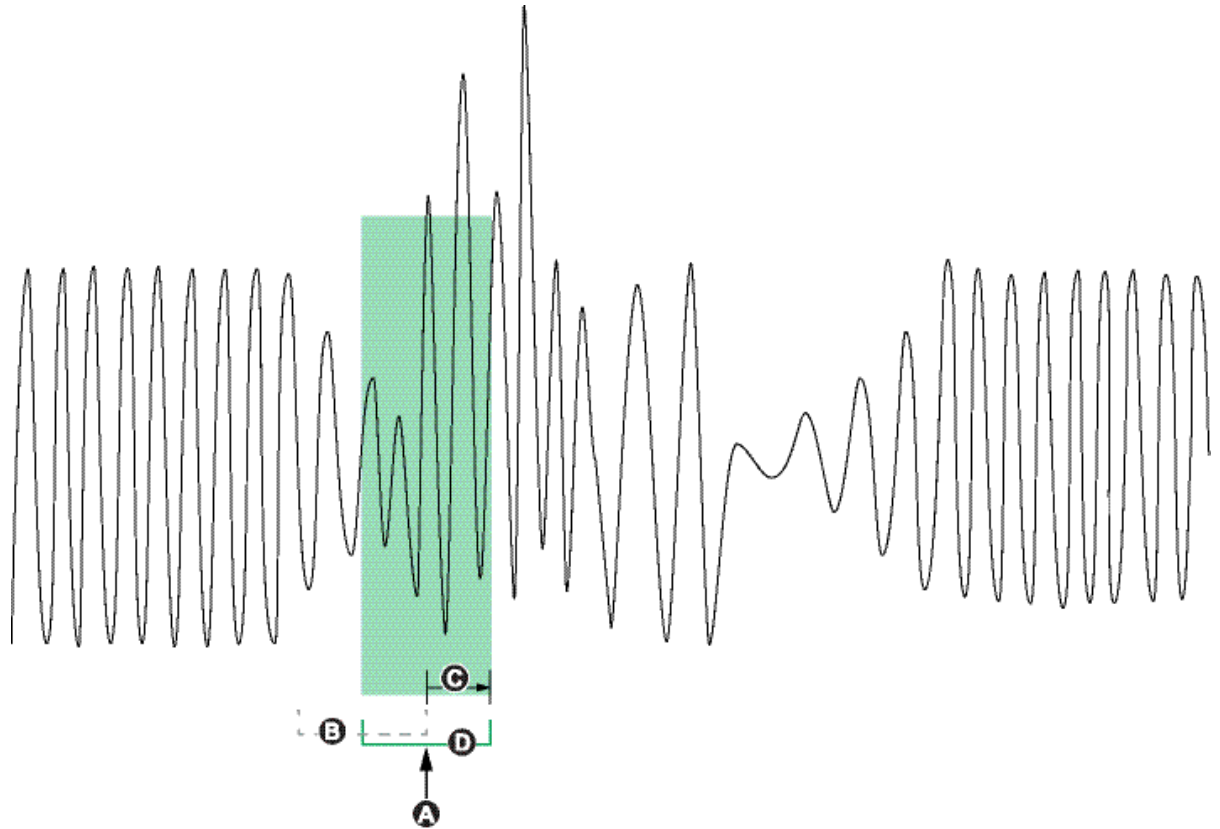

A	Waveform recording triggered
B	Waveform record if <i>Record Delay Cycles</i> was set to zero
C	Delay period (number of cycles specified in <i>Record Delay Cycles</i> setup register)
D	Delayed waveform capture recorded in waveform log

Extended waveform capture

The meter's Waveform Recorder modules support extended waveform capture.

The Waveform Recorder module's *Pre-trigger Records* setup register specifies how many pre-event records are saved with each triggered recording. The *Post-trigger Records* setup register specifies how many post-event records are saved with each triggered recording.

Both *Pre-trigger Records* and *Post-trigger Records* are set to zero by default. To configure the waveform recorder for extended waveform capture, either or both of these setup registers must be set to a non-zero positive integer value. If you do this, you must also set the *Record Delay Cycles* setup register to zero in order to properly configure the extended waveform capture.

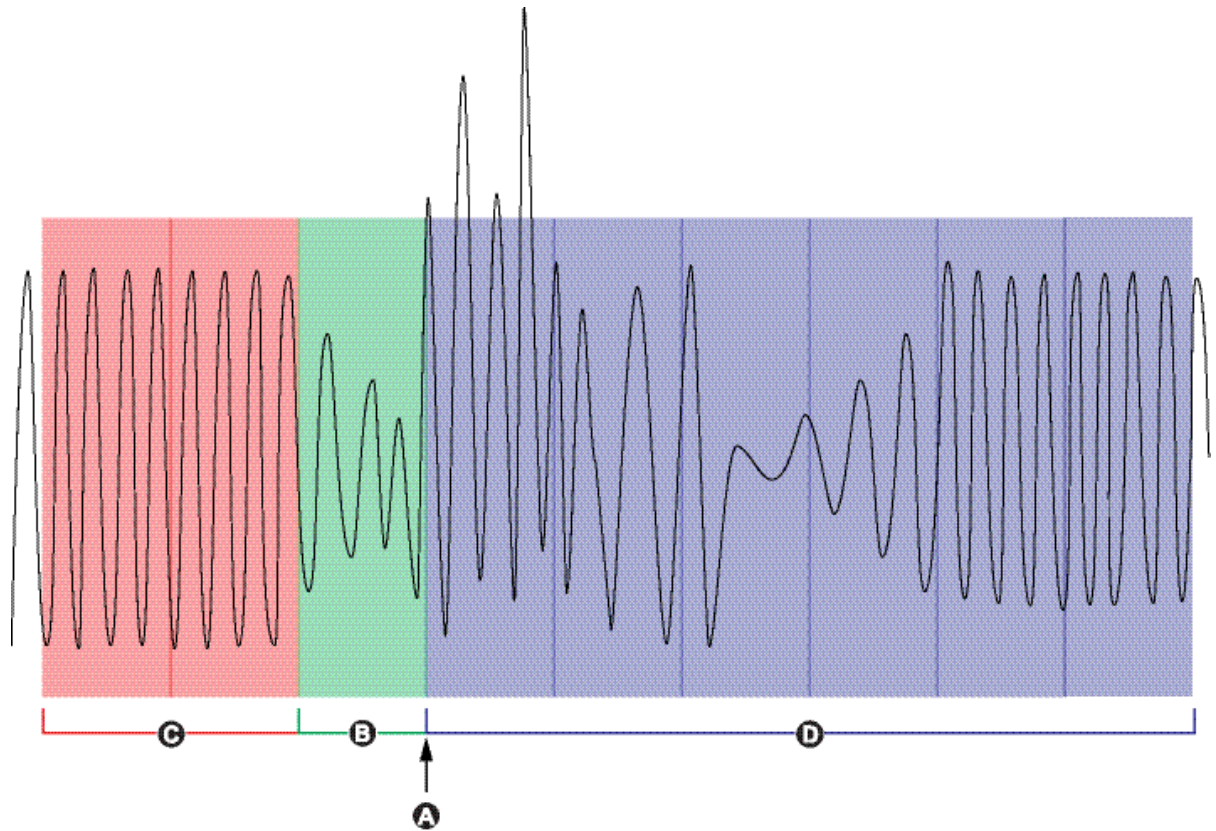

A	Waveform recording triggered
B	Waveform record captured at trigger
C	Pre-trigger waveform records captured
D	Post-trigger waveform records captured

The waveform log set for each triggered recording is equal to the sum of *Pre-trigger Records* + *Post-trigger Records* + 1 (where 1 is the actual record when the Waveform Recorder module's *Record* input was triggered).

For example, if *Pre-trigger Records* is set to 2 and *Post-trigger Records* is set to 6, the number of records for each waveform log set is 9:

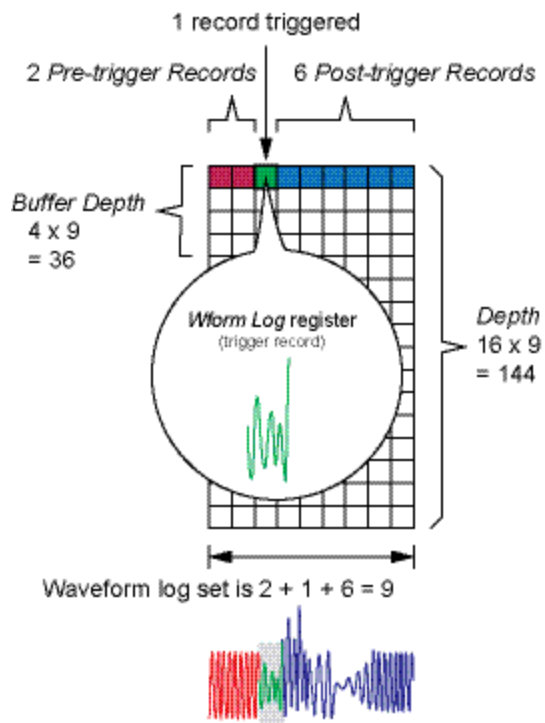

The waveform log set for the extended waveform capture = [pre-trigger records] + [actual trigger record] + [post-trigger records]. The total waveform records captured in this example is 2 + 1 + 6 = 9.

When extended waveform capture is enabled, both *Buffer Depth* and *Depth* setup registers must be set to a positive integer multiple of the waveform log set.

NOTE: The COMTRADE module does not support extended waveform capture. The COMTRADE files saved are only for the trigger waveform record.

Logging

Logging overview

The meter's logging frameworks include factory-configured data recorders, waveform recorders and event logs.

The logging frameworks store data related to:

- Power quality and compliance
- Energy and demand
- Revenue metering
- Trending and forecasting
- Meter events

When your system's nominal parameters are programmed into the meter, power quality events such as sags and swells are automatically detected, and associated voltage and current data and waveforms are logged. Meter data is stored in non-volatile memory, so data is retained even if the meter loses power. If your system nominal values fluctuate, you can configure the meter's setpoint learning feature to learn your power system's normal operating values, then use that information to help identify voltage sags and swells.

The meter's logging framework also supports burst data logging for sag/swell events. When burst data logging is enabled, additional data records immediately before and immediately after the sag/swell event are captured. Energy management systems can then retrieve this information for use in applications such as power event analysis.

NOTE: To maximize the performance of your power management system, it is recommended that devices be connected directly to an Ethernet network.

You can also configure the meter to email data from the logging frameworks. See the *PowerLogic MeterM@il Internal Email Client Feature* technical note, available from www.se.com, for details.

Meter events are recorded in the meter's onboard event log. You can also configure the meter to record events to an external SysLog (systems log) server.

Default data logging configuration

The meter's default framework includes factory-configured data logs (data recorders).

These data logs and their configuration are used by other components of your power monitoring system. Do not change the default configuration of any of the logs unless you understand the impact of the change on these power monitoring system components, the data they use and your meter's memory.

The meter can support up to 50 data logs (data recorders), which can each record up to 16 different parameters.

Revenue log

The Revenue Log (Data Rec 1) is configured for use with UTS MV-90 billing software. Factory settings for this data recorder:

- Log depth = 3360 records (35 days)
- Interval = 900 seconds (15 minutes)

By default, it logs the following values:

Parameter	Description
kWh del int	Interval kWh delivered
kWh rec int	Interval kWh received
kVARh del int	Interval kVARh delivered
kVARh rec int	Interval kVARh received

Historic data logs

Three historic data logs are used to record standard power system quantities, such as phase current, phase voltage and power factor. These logs are labeled Hist Mean Log, Hist High Log, and Hist Low Log. Factory settings for these data recorders:

- Log depth = 3360 records (35 days)
- Interval = 900 seconds (15 minutes)

By default, they log the following values:

Hist Mean Log (Data Rec 2)			
Vll ab mean	V unbal mean	I avg mean	kVA tot mean
Vll bc mean	Ia mean	I 4 mean	PF lag mean
Vll ca mean	Ib mean	kW tot mean	PF lead mean
Vll avg mean	Ic mean	kVAR tot mean	Freq mean

Hist High Log (Data Rec 3)			
Vll ab high	V unbal high	I avg high	kVA tot high
Vll bc high	Ia high	I 4 high	PF lag high
Vll ca high	Ib high	kW tot high	PF lead high
Vll avg high	Ic high	kVAR tot high	Freq high

Hist Low Log (Data Rec 4)			
Vll ab low	V unbal low	I avg low	kVA tot low
Vll bc low	Ia low	I 4 low	PF lag low
Vll ca low	Ib low	kW tot low	PF lead low
Vll avg low	Ic low	kVAR tot low	Freq low

Loss log

The Loss Log (Data Rec 9) is configured to record loss values. Factory settings for this data recorder:

- Log depth = 3360 records (35 days)
- Interval = 900 seconds (15 minutes)

By default, it logs the following values:

Parameter	Description
MU Ia ² h int	Phase A interval current squared hours
MU Ib ² h int	Phase B interval current squared hours
MU Ic ² h int	Phase C interval current squared hours
MU Vllab ² h int	Phase A interval voltage Line-to-Line squared hours
MU Vllbc ² h int	Phase B interval voltage Line-to-Line squared hours
MU Vllca ² h int	Phase C interval voltage Line-to-Line squared hours
MU Vln a ² h int	Phase A interval voltage Line-to-Neutral squared hours
MU Vln b ² h int	Phase B interval voltage Line-to-Neutral squared hours
MU Vln c ² h int	Phase C interval voltage Line-to-Neutral squared hours

Harmonics logs

Two harmonics logs record various harmonics data, including K-factor and Total Harmonic Distortion (THD). These recorders are labeled Harm Mean Log and Harm High Log. Factory settings for these data recorders:

- Log depth = 840 records (35 days)
- Interval = 3600 seconds (1 hour)

By default, they log the following values:

Harm Mean Log (Data Rec 7)		
V1 THD mean	I1 THD mean	I1 K Fac mean
V2 THD mean	I2 THD mean	I2 K Fac mean
V3 THD mean	I3 THD mean	I3 K Fac mean

Harm High Log (Data Rec 8)		
V1 THD high	I1 THD high	I1 K Fac high
V2 THD high	I2 THD high	I2 K Fac high
V3 THD high	I3 THD high	I3 K Fac high

Energy and demand log

The EgyDmd Log (Data Rec 10) records energy and demand data used by energy management software to generate reports. Factory settings for this data recorder:

- Log depth = 3360 records (35 days)
- Interval = 900 seconds (15 minutes)

By default, it logs the following values:

Parameter	Description
kWh del	Active energy delivered
kWh rec	Active energy received
kWh del-rec	Active energy delivered minus received
kVARh del	Reactive energy delivered
kVARh rec	Reactive energy received
kVARh del-rec	Reactive energy delivered minus received
kVAh del+rec	Apparent energy delivered plus received
kW sd del-rec	Active power demand delivered minus received
kVAR sd del-rec	Reactive power demand delivered minus received
kVA sd del+rec	Apparent power demand delivered plus received

Daily nominal log

The DailyNom Log (Data Rec 39) provides information about the meter's nominal settings.

Factory settings for this data recorder:

- Log depth = 450 records
- Interval = Triggered on demand

By default, it logs the following values from the Factory module's setup registers:

Parameter	Description
FAC1 Vnominal	Nominal voltage setting
FAC1 NomFreqNum	Expected frequency of operation

Sag/swell log

The Sag/swell Log (Data Rec 5) provides details of power quality events. Factory settings for this data recorder:

- Log depth = 100 records
- Interval = Triggered on demand

By default, it logs the following values:

SS1 DistDur	SS1 DistV1Min	SS1 DistV1Max	SS1 DistV1Avg
SS1 DistV1Engy	SS1 DistV2Min	SS1 DistV2Max	SS1 DistV2Avg
SS1 DistV2Engy	SS1 DistV3Min	SS1 DistV3Max	SS1 DistV3Avg
SS1 DistV3Engy	SS1 DistNominal	SS1 Swell Lim	SS1 Sag Lim

Sg/Sw HS log

The Sg/Sw HS Log (Data Rec 6) captures high-speed (half-cycle) voltage and current data that includes pre-event and post-event records related to the sag/swell event. This data recorder is disabled by default.

If enabled, it logs the following by default:

HS VIn a	HS VII ab	HS I a	HS Freq
HS VIn b	HS VII bc	HS I b	PQA1 Vavg Sliding Ref Voltage
HS VIn c	HS VII ca	HS I c	

EN 50160 compliance logs

The EN 50160 compliance logs are used to record EN 50160 compliance parameters:

Data recorder	EN 50160 component logged
EN50160 Frq/Mg (Data Rec 17)	Power frequency and supply magnitude
EN50160 Hrm VIt (Data Rec 29)	Voltage harmonics
EN50160 Intrp (Data Rec 24)	Short/log interruptions
EN50160 Prm-f/V (Data Rec 32)	Parameter data (disabled by default)
EN50160 PrmHrm1 (Data Rec 12)	Parameter data (disabled by default)
EN50160 PrmHrm2 (Data Rec 11)	Parameter data (disabled by default)
EN50160 Swell (Data Rec 25)	Voltage swells
EN50160 VIt Dp1 (Data Rec 19)	Supply voltage dips
EN50160 VIt Dp2 (Data Rec 20)	Supply voltage dips
EN50160 Vunbal (Data Rec 28)	Voltage unbalance

The meter logs EN 50160 counter data for present and previous observation periods as well as EN 50160 events.

See the *Power Quality: ION Meters and EN50160* technical note, available from www.se.com, for details.

IEC 61000-4-30 compliance logs

The IEC 61000-4-30 compliance logs are used to log parameters related to the International Electrotechnical Commission's IEC 61000-4-30 standards' power quality compliance and to create reports:

4-30 3s RMS Log (Data Rec 38)			
PqFlag 2s ivd	I1 3s	V1 OverDev 3s	V3 OverDev 3s
V1 3s	I2 3s	V2 UnderDev 3s	
V2 3s	I3 3s	V2 OverDev 3s	
V3 3s	V1 UnderDev 3s	V3 UnderDev 3s	

4-30 10mRMS Log (Data Rec 16)			
PqFlag 10m	PQA1 I1 10m	V1 OverDev 10m	V3 OverDev 10m
V1 10m	PQA1 I2 10m	V2 UnderDev 10m	Power Freq 10m
V2 10m	PQA1 I3 10m	V2 OverDev 10m	
V3 10m	V1 UnderDev 10m	V3 UnderDev 10m	

4-30 2hrRMS Log (Data Rec 37)			
PqFlag 2hr	I1 2hr	V1 OverDev 2hr	V3 OverDev 2hr
V1 2hr	I2 2hr	V2 UnderDev 2hr	Power Freq 2hr
V2 2hr	I3 2hr	V2 OverDev 2hr	
V3 2hr	V1 UnderDev 2hr	V3 UnderDev 2hr	

4-30 3s THD Log (Data Rec 26)			
PqFlag 3s THD	V3 THD 3s	I3 THD 3s	IUnbal u2 3s
V1 THD 3s	I1 THD 3s	Vunbal u2 3s	IUnbal u0 3s
V2 THD 3s	I2 THD 3s	Vunbal u0 3s	

4-30 10mTHD Log (Data Rec 27)			
PqFlag 10m	V3 THD 10m	PQ I3 THD 10m	IUnbal u2 10m
V1 THD 10m	PQ I1 THD 10m	Vunbal u2 10m	IUnbal u0 10m
V2 THD 10m	PQ I2 THD 10m	Vunbal u0 10m	

4-30 2hrTHD Log (Data Rec 34)			
PqFlag 2hr	V3 THD 2hr	I3 THD 2hr	IUnbal u2 2hr
V1 THD 2hr	I1 THD 2hr	Vunbal u2 2hr	IUnbal u0 2hr
V2 THD 2hr	I2 THD 2hr	Vunbal u0 2hr	

4-30 10s Freq (Data Rec 21)	
Power Frequency	PqFlag 10s

4-30 Intrap Log (Data Rec 22)
V Intrap DrtnAll (voltage interruption duration - all voltages)

See the *IEC 61000-4-30 compliance and ION meters* technical note, available from www.se.com, for details.

IEEE 519 compliance logs

The IEEE 519 compliance logs are used to record IEEE 519 compliance parameters:

Data recorder	IEEE 519 component logged
519 Hrm I-X (Data Rec 35)	Current harmonics
519 Hrm I-Y (Data Rec 36)	Current harmonics
519 Hrm I-Z (Data Rec 14)	Current harmonics
519 Hrm V-X (Data Rec 42)	Voltage harmonics
519 Hrm V-Z (Data Rec 13)	Voltage harmonics

Configuring data logging using ION Setup

Use ION Setup to configure the meter's data recorders.

Changing the meter's data recorder configuration clears existing data in that data recorder.

NOTICE

DATA LOSS

Ensure that all important data is recorded before configuring data recording.

Failure to follow these instructions can result in data loss.

To configure data logging using ION Setup:

1. Start ION Setup.
2. Open the **Setup Assistant** for your meter.
3. Click **Logging > Memory**.
4. In the **Status** tab, select the data log and click **Edit**.

The **Log Depth Setup** window appears.

5. Configure the settings as applicable:

Parameter	Description
Log Interval	How frequently records are logged
Log Depth	Maximum number of records stored in the log
Log Memory	Information only. This is automatically calculated, and displays how much memory the log uses based on the Log Interval and Log Depth

Parameter	Description
Log Storage	Information only. This is automatically calculated, and displays how much total memory is left after subtracting the Log Memory usage

Waveform recording

The meter's factory-configured waveform recorders store waveform data related to power quality events.

Waveform information is used to help identify power system disturbances, which are an increasing concern for industrial plants, hospitals, data centers and other facilities where the equipment is sensitive to voltage or current sags, swells, and momentary interruptions. Waveform information is also used to help ensure compliance with power quality standards.

In addition to measuring and recording numerical values for voltage and current, your meter can also capture the sinusoidal waveform data. The current and voltage waveform data provides additional information for analysis of the system's power quality or a power quality event.

When your system's nominal parameters are programmed into the meter, power quality events such as sags and swells are automatically detected and voltage and current waveform data is logged. The default factory settings for sag/swell detection are sufficient for most applications, but you can also modify the amount of deviation from the nominal required to trigger waveform recording.

Waveform data storage format

Your meter's waveform data storage format is defined by:

- Cycles: the number of cycles included in the waveform (its duration).
- Samples: samples per cycle, which is the number of waveform data points collected in each cycle.

This gives you the option to record a lot of information for a very short duration or less information over a longer duration. You can also configure the waveform recording to record pre-event and post-event data.

Types of waveform data

You can use your meter to detect ITI (CBEMA) - type disturbances, and determine information regarding the magnitude and duration of each disturbance. This information can be used by your energy management system to plot the disturbance on an ITI (CBEMA) curve.

COMTRADE waveform data is available from your meter.

NOTE: If you are generating COMTRADE waveform information, the associated waveform recorders cannot be modified unless COMTRADE is disabled. If the waveform recorders are not configured identically, COMTRADE waveform information will not be generated.

Key terms

Term	Definition
COMTRADE	COMMon format for TRAnsient Data Exchange (COMTRADE) is a common format for waveform data.
ITI (CBEMA)	A curve that graphically describes an AC input voltage envelope which can be typically tolerated by information technology equipment. Meter waveform information is plotted on this curve to help evaluate power quality.
Nominal	The normal or usual parameter value. For example, the nominal voltage for many power systems is 120 V.
Sag	A power event where the voltage or current drops below the nominal value.
Swell	A power event where the voltage or current rises above the nominal value.

See *ION Reference*, available from www.se.com, for more information on the Waveform Recorder module and its settings.

Default waveform recording configuration

The meter's default framework includes factory-configured waveform logs (waveform recorders).

These waveform logs and their configuration are used by other components of your power monitoring system. Do not change the default configuration of any of the logs unless you understand the impact of the change on these power monitoring system components, the data they use and your meter's memory.

Waveform Recorder modules

The factory-default Waveform Recorder modules are preconfigured to capture sag/swell power quality events.

Waveform recorder	Description
Wfm Rc V1-Sg/Sw (Wform Rec 1)	V1 voltage waveforms recorded during a defined sag or swell event.
Wfm Rc V2-Sg/Sw (Wform Rec 2)	V2 voltage waveforms recorded during a defined sag or swell event.
Wfm Rc V3-Sg/Sw (Wform Rec 3)	V3 voltage waveforms recorded during a defined sag or swell event.
Wfm Rc I1-Sg/Sw (Wform Rec 5)	I1 current waveforms recorded during a defined sag or swell event.
Wfm Rc I2-Sg/Sw (Wform Rec 6)	I2 current waveforms recorded during a defined sag or swell event.

Waveform recorder	Description
Wfm Rc I3-Sg/Sw (Wform Rec 7)	I3 current waveforms recorded during a defined sag or swell event.

COMTRADE modules

The factory-default COMTRADE modules are preconfigured with their inputs linked to the *Trigger* outputs of the waveform recorders for sag/swell monitoring.

COMTRADE 1 inputs (sag/swell)	Linked Waveform Recorder (<i>Trigger</i> output)
<i>Waveform Trigger 1</i>	Wfm Rc V1-Sg/Sw (Wform Rec 1)
<i>Waveform Trigger 2</i>	Wfm Rc V2-Sg/Sw (Wform Rec 2)
<i>Waveform Trigger 3</i>	Wfm Rc V3-Sg/Sw (Wform Rec 3)
<i>Waveform Trigger 4</i>	Wfm Rc I1-Sg/Sw (Wform Rec 5)
<i>Waveform Trigger 5</i>	Wfm Rc I2-Sg/Sw (Wform Rec 6)
<i>Waveform Trigger 6</i>	Wfm Rc I3-Sg/Sw (Wform Rec 7)

Event log

Your meter records events produced by the meter's ION modules or external meter events.

Meter events, such as meter configuration or changes to I/O state, have priority values associated with them, so you can control what events are logged. Each event has a priority based on its type and severity, and for most events you can configure the priority. The event log records the date and time of the event, along with relevant details about the event.

Your meter's event log can be viewed through ION Setup and the display.

Default event log configuration

Your meter logs all configuration changes, meter access events, and power system events.

You can configure certain features, such as the digital inputs, so an event is logged when the feature changes state (for example, the digital input changes from off to on).

Your meter's event log might be used by other components of your power monitoring system. Do not change the default event log configuration unless you understand the impact of the change on the power monitoring system components and the data they use and on your meter's memory.

Changing the default event log configuration should only be undertaken by those with an advanced understanding of ION architecture and their meter's template.

The event log is controlled by the Event Log Controller module, which allows you to set a priority cutoff for event logging. Events with a priority number greater than the cutoff value are logged, and events with lower priorities are discarded. By default, this value is set so that all relevant events are recorded in the meter's event log. Event priority values range from 0 to 255 with a typical cutoff value of 5.

NOTE: Alarms are generated by events from certain ION modules. The alarm level is determined by the priority of the associated event. To disable the alarm but still record the associated event, set the alarm priority to **Info Only**. To disable the alarm and the event, set the alarm priority to **None**.

See *ION Reference*, available from www.se.com, for more information about the Event Log Controller module and event priorities for specific ION modules.

User triggered event log entries

The Event Log includes an association between security-related events and the username that was logged in to the meter during the event.

When a user produces an event, such as a reset, successful or unsuccessful login attempts, user lockout or setup change, it is written to the event log. Events created in advanced security through ION Setup or the display are associated with the username that was logged into the meter (USER1 - USER50).

Unread events in event log

View unread events in the event log. Log into ION Setup as the designated reader and switch ION Setup into Advanced mode to view unread events. A customized framework is required to setup notifications for unread events.

Assigning a designated reader for event log notification

A user can be assigned the role of designated reader for the event log.

When the *Designated Reader* is configured, an entry in the event log is considered unread until it is reviewed or backed up to external storage by the designated reader. When the designated reader is informed that the event log is nearly full, an event log review or backup strategy can be implemented before older entries are overwritten. This feature can assist in ensuring that event log entries are not overwritten before they can be reviewed. Use ION Setup to select a user to be the designated reader.

1. Open ION Setup.
2. Ctrl + click on the meter to select it. This switches ION Setup to Advanced mode.
3. Open the EventLogCtl Modules folder and double click **EventLogCtl**.
4. Enter login credentials as necessary.
5. Click the **Setup Registers** tab.
6. Select *Designated Reader* and click **Edit**.
7. Set *Designated Reader* to the user that reviews the event log (USER0 - USER50) and click **OK**.

Syslog

Syslog uses the User Datagram Protocol (UDP) to transport event log information from the meter directly to a centralized syslog server.

The syslog server can receive logs from multiple devices, including meters, then store and filter the log information as needed. You can use ION Setup to modify the syslog network settings for your device. Syslog is a useful feature to help maintain meter log information for extended periods of time.

NOTE: Ethernet is required to use the syslog feature.

Syslog is an open standard allowing you to use any one of a number of syslog server applications currently available. The decision regarding which syslog server solution to use can be based on budget and your technical requirements. See the individual syslog server's documentation for more information.

Configuring Syslog network settings using ION Setup

To configure Syslog network settings using ION Setup:

1. Start ION Setup.
2. Open the **Setup Assistant** for your meter.
3. Click **Communications > Advanced Ethernet > SysLog**.
4. Select **Enable Syslog** and click **Edit**.
5. Select **Yes** to enable the syslog server feature or select **No** to disable it.
6. Click **OK**.
7. Select **Syslog Server** and click **Edit**.
8. Enter the IPv4 address or an IPv6 address for the syslog server.

NOTE: You must enter the IP address for the syslog server, not the server's fully-qualified domain name.

9. Click **OK**.
10. Verify that the Syslog server is receiving log information from the meter.

NOTE: If the *Enable Syslog* register is enabled but the *Syslog Server* register does not contain an IP address, an event is generated in the event log to indicate that syslog is enabled with no server IP.

Syslog severity to event log priority mapping

Syslog severities map to ION event priorities (0–255).

Only four of the syslog severities are used in the mapping.

Syslog severity	ION event priority name	ION event priority range
2 - Critical condition	High	192–255
4 - Warning condition	Medium	128–191

Syslog severity	ION event priority name	ION event priority range
5 - Normal but significant condition	Low	64–127
6 - Informational	None	0–63

Advanced log setup and memory optimization

You can configure your meter's logs to help ensure the integrity of critical data and to optimize the meter's memory usage.

Before you configure your meter's logs, it is important to understand how logging functions and how the settings work together.

NOTE: Configuring your meter's logs requires an in-depth understanding of the meter's memory, how the logs function and the data you are capturing.

Viewing log configuration and memory usage information

You can use ION Setup to view log settings and memory usage information for your meter's default logs.

This information can help you understand your log usage and how to optimize your logging configuration for your situation.

1. Start ION Setup.
2. Open the **Setup Assistant** for your meter.
3. Click **Logging > Memory** screen.

The Status tab:

- Lists the default logs, their interval (**Duration**) and depth (**Records**), if applicable, and the percentage of available memory used by the log.
- Provides information on how much of the meter's memory is used for system tasks in the System Resources list item.
- Displays the total meter memory and the percentage of memory in use versus memory available.

Log depth configuration

You can change the number of records (depth) stored in the log.

Use ION Setup to change the maximum number of records (depth) stored in the log in the meter's long-term memory.

Data logs and circular-format waveform recorders have a minimum depth of 1 record. The maximum depth is dependent on your meter's memory and the configuration of your other logs.

Log interval configuration

You can configure the logging interval, which is how frequently records are logged.

You can change the logging intervals for most logs using the ION Setup Assistant **Logging > Memory** screen.

Changing the interval for other logs (for example, logs that are related to standards or triggered by disturbances) is an advanced procedure that involves using the Advanced mode of ION Setup to modify settings in the module that is linked to the log's *Record* input. See the ION Setup help and the *ION Reference* for more information.

Programming your meter to write to any data recorder at continuous intervals shorter than 60 seconds (heavy logging configuration) can cause loss of data in the event of a power failure.

NOTICE

DATA LOSS

Use an uninterruptible power supply (UPS) if you program your meter for heavy logging.

Failure to follow these instructions can result in data loss.

Log mode configuration

You can configure the log record mode, or how the log behaves when full.

Changing how the log records information (circular or stop-when-full) is an advanced procedure that requires changing the *RecordMode* setup register in the Data Recorder and Waveform Recorder modules.

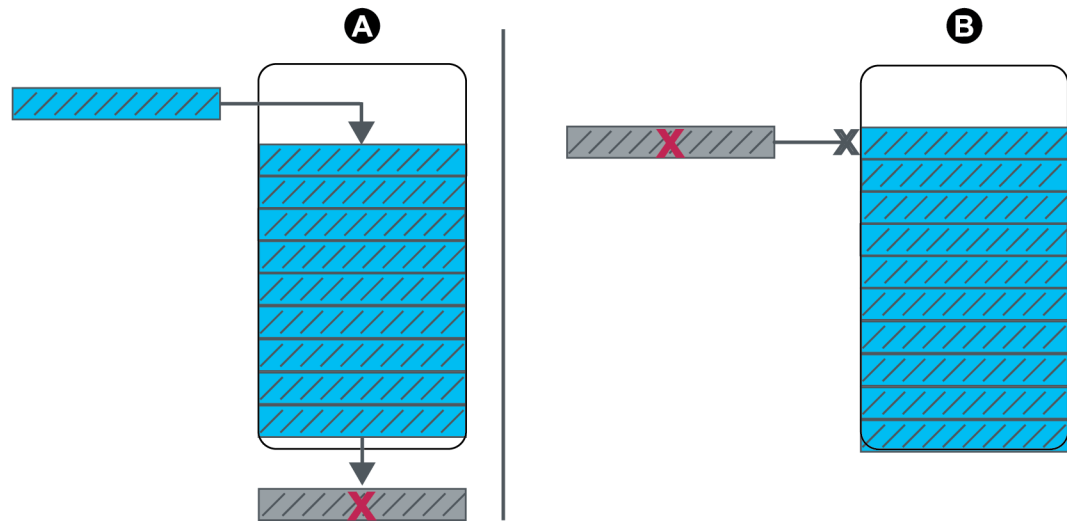

- | | |
|---|---|
| A | Circular (FIFO) logging mode: when the log is full, a new record overwrites the oldest record |
| B | Stop-when-full logging mode: when the log is full, any new records are not logged |

Log buffer configuration

The log buffer depth is the maximum number of records that can be stored in the meter's short-term memory (RAM) for a particular log.

After records are captured in the log buffer in the meter's short-term memory, they are replicated to the long-term memory. Because of inherent differences between short-term (volatile) and long-term (non-volatile) memory, records can be added more quickly to the short-term memory than they can be copied to long-term memory.

The logs in the default logging framework have their log buffer depths pre-configured to a value suitable for most applications. But you can configure the log buffer depth for your applications, if required (for example, to help ensure the continuity of critical data in high-speed logging scenarios or to optimize usage of your meter's memory for your particular logging configuration).

If you are logging data at high speeds, it is important to review your logging needs, and find the right balance between data retention and memory optimization for your particular situation.

NOTE: If you get a message that you do not have sufficient memory when you try to create a new log or change the configuration of an existing log, you may need to reduce the log buffer depths of other logs in order to make memory available for the new log.

Fully buffered logs

A fully buffered log (e.g., a Data Recorder or Waveform Recorder module) is one where the value of the Buffer Depth setup register is the same as the Depth setup register. This means the buffer (short-term memory) is set up to use all the available long-term memory allocated for that log. This ensures the buffer does not run out of space before all the records are replicated to the long-term memory, regardless of the recording speed (i.e., the rate of record captures).

You may want to use this configuration if you are logging critical data (for example, revenue logs) or logging data at frequent intervals (for example, intervals less than 60 seconds). However, it is important to note that this configuration uses the most short-term memory, or RAM (the meter has a maximum 10 MB of RAM available for the log buffer depth).

Partially buffered logs

A partially buffered log (e.g., for a Data Recorder or Waveform Recorder module) is one where the value of the Buffer Depth setup register is less than the Depth setup register. This means the buffer (short-term memory) is set up to use only a portion of the available long-term memory allocated for that log. This configuration allows for a larger log size (i.e., number of records). However this does not ensure that the buffer does not run out before all the records are replicated to the long-term memory (e.g., in the case of high-speed recording).

You may want to use this configuration for logs with intervals greater than 60 seconds or with less critical data. Because the records are partially replicated, this configuration uses less of the meter's short-term memory, or RAM, in a log that is otherwise configured the same. This allows you to make more RAM available for other logs with a higher logging frequency or more critical data.

However, depending on your configuration, there may be instances where the log buffer fills up faster than it can replicate records to long-term memory. In this case, you may lose records and see gaps in your data.

NOTE: The *Insert Outage Records* functionality does not work if the data recorder is configured as partially buffered. In order to use this functionality, you must configure the data recorder to be fully buffered. See *ION Reference*, available from www.se.com, for more information about configuring the Data Recorder module.

Example: Fully buffered log records replicated from short-term to long-term memory

In the following example, the log buffer equals the log depth and all the records are replicated in both the short-term memory and the long-term memory.

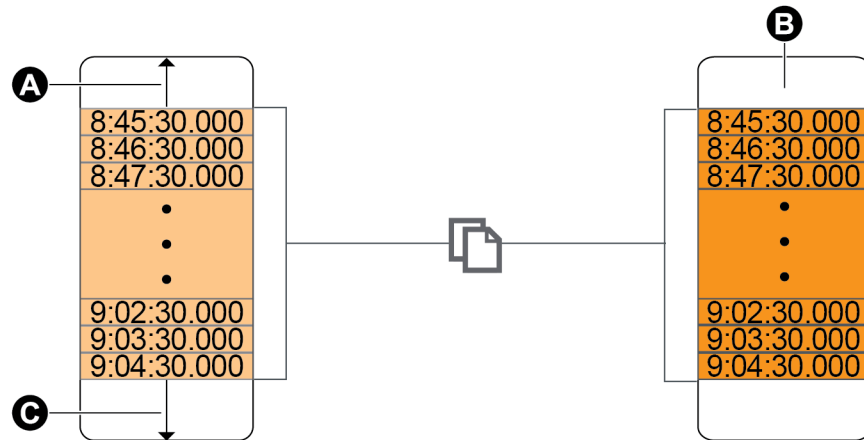

A	Log buffer
B	Long-term memory
C	Total available space in the log buffer (for example, 20 records)

Example: Partially buffered log records replicated from short-term memory to long-term memory

In the following example, the buffer depth equals 20. The first record has already replicated to the long-term memory, making room in the log buffer for the new records (including the newest record, in gray).

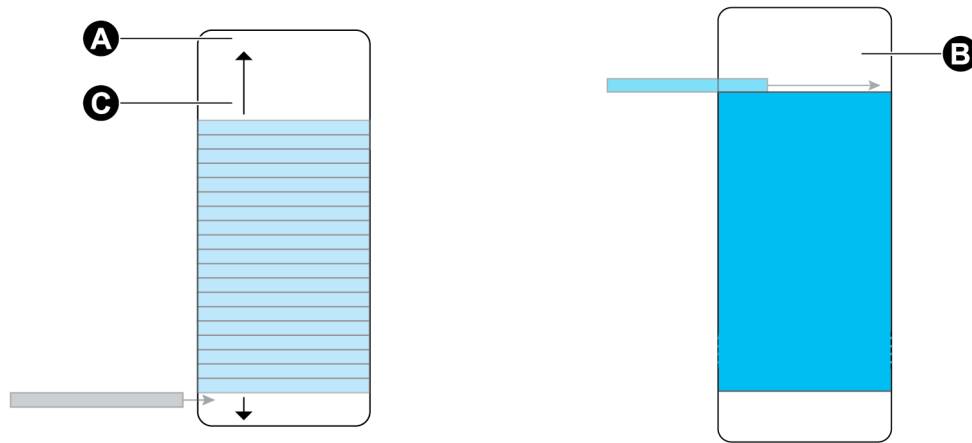

A	Log buffer
B	Long-term memory
C	Total available space in the log buffer (for example, 20 records)

Example: Resulting gaps in data when a partially buffered log is full

In the graphic on the left, the log buffer (A) is full, and the oldest record has not replicated to the long-term memory yet. This means that the new record (C) is not logged, and is permanently lost. In the graphic on the right, the oldest record (D) was replicated to long-term memory, making space in the buffer. The new record at the next interval (E) is logged but there is a gap in the data for the lost record (C).

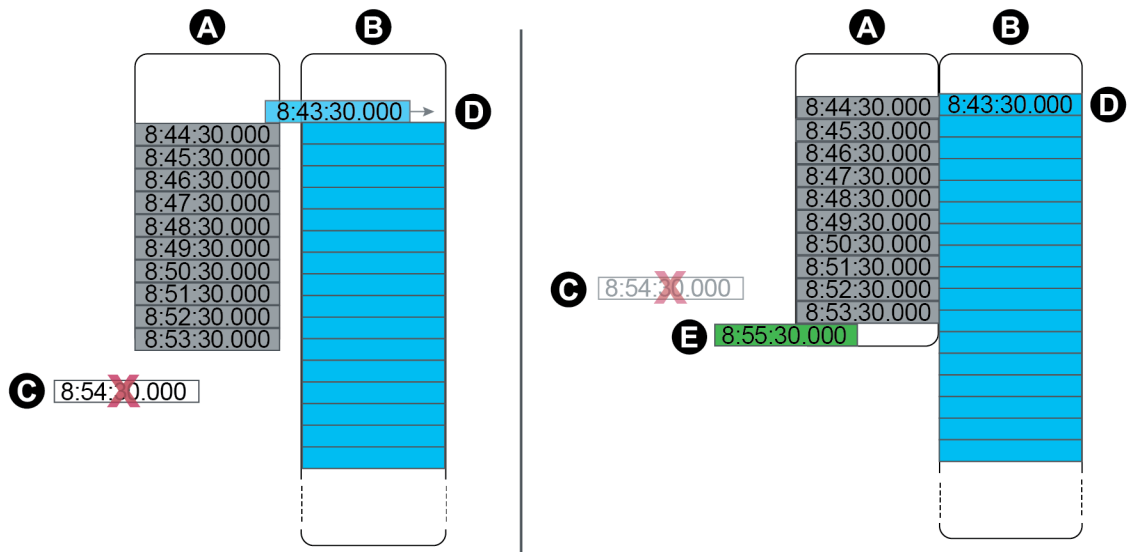

A	Log buffer
B	Long-term memory

C	Record that cannot be logged because log buffer is full (this record is lost)
D	Record moving from short-term memory to long-term memory
E	New record at next interval

Changing log interval and depth settings using ION Setup

You can configure log intervals, log depths and buffer depths to optimize your memory usage. Before you begin, make sure you understand:

- the structure of the meter's logging framework
- the meter's existing logging configuration
- your data logging requirements

Changing your meter's log configuration deletes all existing records from that log.

NOTICE

DATA LOSS

Ensure that all important data is recorded before configuring a log.

Failure to follow these instructions can result in data loss.

The default log settings are designed to meet the needs of most users.

This procedure provides the steps for configuring settings for a subset of data logs using the ION Setup Assistant. Configuring these settings for custom logs, and logs not listed in the **Logging > Memory** screen, is an advanced procedure; see the ION Setup help for more information.

1. Start ION Setup.
2. Open the **Setup Assistant** for your meter.
3. Click **Logging > Memory**.
4. Select the log you want to edit and click **Edit**.
5. Set the log depth and log interval as required for your logging needs.
 - **Log Interval:** you can change the interval units to seconds, minutes, hours or days.
 - **Log Depth:** You can set the depth in time (seconds, hours, days, etc.) or the number of records.

NOTE: For some log types, you only set the log depth (for example, waveform recorders).

Log Memory shows the estimated impact of the changes on the total size of the log and **Log Storage** displays the estimated available log memory on the meter.

NOTE: If you receive a message stating that there is not enough memory when you change a log's configuration, check the configuration of your meter's other logs. You may not have enough RAM, or short-term memory, to allow for the new configuration. You may need to use Advanced mode to check the detailed configuration of your logs.

6. Click **Finish**.

NOTE: You may see a **Next** button instead of **Finish**. In this case, the next screen allows you to configure the buffer depth for the log. The screen displays the overall log depth and a field for setting the log buffer depth. It also shows the impact of the **Buffer Depth** setting to your meter's short-term memory (RAM).

Time and timekeeping

Time and timekeeping overview

Your meter's internal clock is used for keeping time, timestamping data, and determining intervals for time-based measurements.

Local meter time is displayed based on the meter's time sync source and the settings used for timezone and daylight savings time. You can configure and view your meter's date and time information using ION Setup, or the display.

Your meter monitors time using the frequency of an internal oscillator or the frequency of the line power being measured. Your meter's battery powers the internal clock so that time is maintained when the meter is unpowered.

Your meter supports different time types and time synchronization methods to adjust its internal clock. To improve your meter clock's accuracy, you can use an external time reference such as a Global Positioning System (GPS) signal, Network Time Protocol (SNTP/NTP) server or Precision Time Protocol (PTP) Master.

See the *Time Synchronization and Timekeeping* technical note, available from www.se.com, for details.

See *ION Reference*, available from www.se.com, for a detailed description of the Clock module operation.

Internal clock temperature compensation

The time accuracy of the meter has been improved by compensating for clock drift if the meter's operating temperature falls outside the optimum temperature range.

Your meter's internal clock is adjusted based on the internal clock temperature compensation parameters.

Time synchronization

Your meter's clock controls the timing of metering parameters, such as demand intervals or power quality measurement aggregation over time intervals.

Adjustments to the clock are made by synchronizing the meter's time with another time source, determined by the *Time Sync Source*. Time synchronization messages can be automatically generated and sent to your meter from your energy management system software or other time sources such as an SNTP/NTP server, PTP Master or GPS receiver. You can also manually trigger a time synchronization message from your energy management system or configuration software.

NOTE: To help maintain data integrity, some energy management systems impose a blackout rule where time synchronization messages near energy interval boundaries are ignored.

Supported time synchronization sources

Several time synchronization sources are available to your meter.

Time sync source	Description
Meter configuration software (ION Setup)	Configuration software can manually synchronize the time of your meter based on the clock of the computer running the configuration software. Configuration software synchronization is usually performed when the meter is initially commissioned.
Energy management system	Energy management systems can synchronize the time of your meter to be consistent with other meters on the network.
GPS receiver (IRIG-B) ¹	A GPS receiver using IRIG-B can synchronize the time of a meter up to ± 1 ms of Coordinated Universal Time (UTC). A dedicated serial network is required to implement a GPS scheme. For IRIG-B, one of your meter's digital inputs must be connected to the IRIG-B network, and the digital input must be configured for IRIG-B time synchronization in addition to configuring your meter's clock.
GPS over serial	A GPS receiver can synchronize the time of a meter up to ± 1 ms of Coordinated Universal Time (UTC). For GPS over serial, your meter's serial port must be connected to a GPS receiver, and the serial port communications must be configured with the correct protocol setting.
Simple Network Time Protocol (SNTP)	SNTP can synchronize the time of your meter up to ± 1 second of other meters on an Ethernet network. For SNTP time synchronization, your meter must be connected to an Ethernet network that has an active SNTP server and be configured with the server's information.
Network Time Protocol (NTP)	NTP can typically synchronize the time of a meter to ± 10 to 100 ms, depending on network configuration. To implement NTP time synchronization, your meter must be connected to an Ethernet network that has an active NTP server and be configured with the server's information.
Precision Time Protocol (PTP) ²	PTP can synchronize the meter time to ± 1 ms of other devices connected to a local area network. To implement PTP time synchronization, your meter must have PTP selected as the time sync source and be connected to an Ethernet network that has a valid PTP Master (Grandmaster Clock).

Clock source

The *Clock Source* setup register defines the meter's representation of a one second period, and can be set to:

¹Use the digital inputs located on the meter base for IRIG-B time synchronization and other high-accuracy applications.

²This clock precision assumes your meter is installed in a Star network topology only.

Setting option	Description
Line Frequency	<p>The meter monitors the ISO Grid Operation line frequency, and adjusts the one second period based on the measured line frequency. All devices connected to the grid network are synchronized to maintain a consistent time base. If a power outage occurs, the clock automatically synchronizes with the meter's internal crystal until power is restored. Once power is restored, the clock resynchronizes with the line frequency.</p> <p>NOTE: Do not use line frequency when your meter is synchronized to an external time sync source.</p>
Internal	The meter clock is synchronized to the meter's internal crystal.
Comm	<p>The meter clock is synchronized to an external time sync source. Use this for the <i>Clock Source</i> if:</p> <ul style="list-style-type: none"> • The <i>Time Sync Source</i> setup register is set to a serial communications port to receive GPS time synchronization signals. • The <i>Time Sync Source</i> setup register is set to ETHERNET-PTP and your meter is installed in a trusted PTP network. • The <i>Time Sync Source</i> setup register is set to IRIG-B.

Clock source time quality flag

The meter's clock source time quality flag is primarily used to report time quality information for digital input events, such as status alarms, in Sequence-of-Events Recording (SER) applications.

The meter keeps track of the time difference between the meter's internal clock and the time sync source.

When the meter's Clock module's *Use Clock Source Qual Flag* is set to use flag, the Diagnostics module's *Receiver Status* output register is set to:

- LOCKED if the time difference between the GPS time sync source or PTP master and meter clock is within ± 1 ms of each other
- UNLOCKED if the time difference between the GPS time sync source or PTP master and meter clock is greater than ± 1 ms of each other

PTP system setting recommendations

By default, your meter is configured to be compatible in typical PTP supported systems.

In a PTP system, the grandmaster clock determines the reference time for the entire system. To ensure correct implementation and operation of the protocol, it is recommended to set the following parameters in your system grandmaster clock:

Parameter	Setting	Description
PTP device type	End to End transparent clock	A transparent clock that supports the use of the end-to-end delay measurement mechanism between slave clocks and the master clock.
Peer delay mechanism	2 step	A clock that provides time information using the combination of an event message and a subsequent general message.
Clock domain	0–3	A logical grouping of clocks that synchronize to each other using the protocol, but that are not necessarily synchronized to clocks in another domain
Ethernet switches	PTP V2 compatible	All switches and other devices in the network must support IEEE 1588 PTP V2 to achieve the stated time precision and accuracy

Star network topology

In addition to PTP system related settings, the accuracy of your meter clock also depends on your physical network configuration. A star network topology is required to achieve the level of clock precision specified.

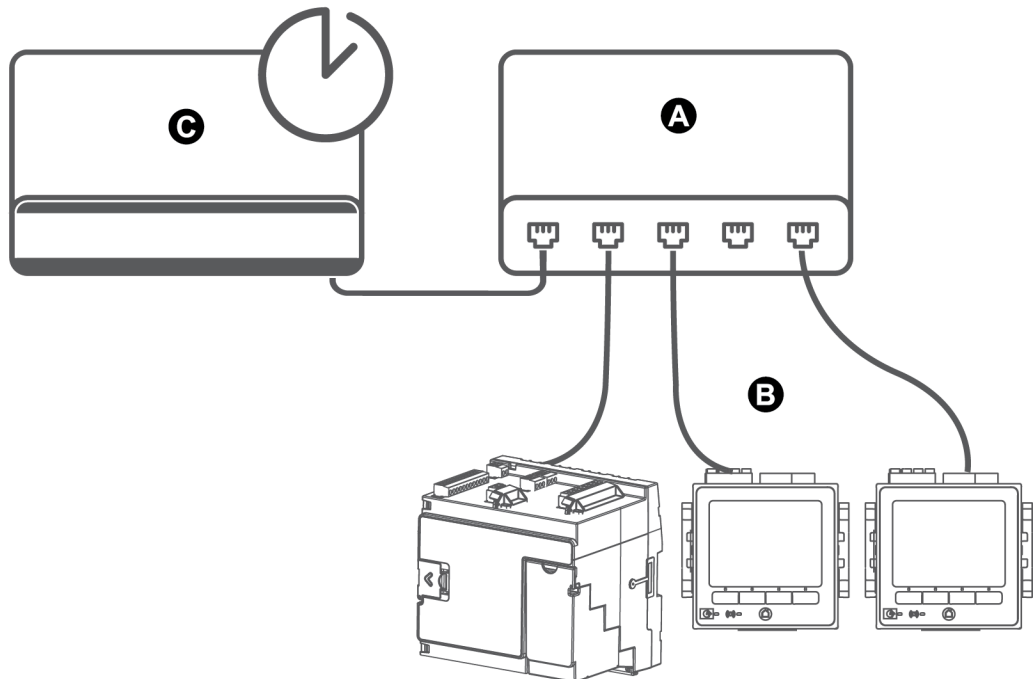

A	Ethernet switch or hub
B	Ethernet connected meters
C	PTP master clock

Configuring time information using ION Setup

You can set the time and date and configure the time synchronization settings using ION Setup.

NOTE: The clock screen is where you set the start day of the week for the time of use feature.

NOTE: You must manually adjust the date and time information if the device is installed in a different time zone location from the computer running ION Setup.

1. Start ION Setup.
2. Open the **Setup Assistant** for your device.
3. Click **Clock > Timezone** tab.
4. Select any parameter and click **TimeSync** to synchronize your device's date and time with the computer that is running ION Setup.
5. Click **DST Settings** to modify your meter's daylight savings time start and end dates, if required.
6. Select the parameter that you want to configure and click **Edit**. Enter the password if prompted.

Parameter	Value	Description
TimeZone	–	Sets the timezone based on the timezones available from the computer's operating system. NOTE: This is also where you can synchronize your meter's DST settings with the computer's.
Time Sync Type	UTC or LOCAL	Specifies the time format of the time sync message. UTC (Coordinated Universal time) is equivalent to Greenwich Mean Time (GMT). LOCAL is the local time with DST and time zone information applied. – For SNTP/NTP and PTP time synchronization, set the Time Sync Type to UTC .

Parameter	Value	Description
Time Sync Source	COM1, ETHERNET, ETHERNET - ION, ETHERNET - DNP, ETHERNET - PTP, IRIG-B	<p>Sets which device port accepts time synchronization messages.</p> <p>Time synchronization messages on other ports are ignored.</p> <ul style="list-style-type: none"> – For GPS time synchronization, set the Time Sync Source to COM1. – For SNTP/NTP time synchronization, set the Time Sync Source to ETHERNET. – For ION time synchronization, set the Time Sync Source to ETHERNET - ION. – For DNP time synchronization, set the Time Sync Source to ETHERNET - DNP. – For PTP time synchronization, set the Time Sync Source to ETHERNET - PTP. – For IRIG-B time synchronization, set the Time Sync Source to IRIG-B.
Clock Source	Internal, Line Freq, COMM	<p>Sets the source for the clock:</p> <ul style="list-style-type: none"> – Internal: the meter's internal clock. – Line Freq: the measured line frequency of the power system is the clock source. – COMM: the meter's communication port (used by the IRIG-B, GPS or ETHERNET - PTP time sync source).
DST Offset	Numeric Bounded Format/Elapsed Interval Format	<p>Specifies the amount of time the displayed local time is moved forward when entering Daylight Savings. A value of zero disables this feature and local time is not adjusted for DST.</p>
Start of the Week	Monday–Sunday	<p>Specifies the start day of the week used for Trending and Forecasting.</p> <p>NOTE: Changing the start day of the week clears all trending and forecasting data.</p>

7. If using SNTP/NTP time synchronization, enter the following information under **Communications > Advanced Ethernet > NTP:**

Parameter	Value	Description
Enable NTP Time Sync	NTP, SNTP, No	NTP: specifies NTP time synchronization. SNTP: specifies SNTP time synchronization. NOTE: SNTP is recommended for revenue-related applications. No: neither NTP nor SNTP time synchronization are used.
NTP Time Sync Interval	Numeric value or elapsed interval value	Specifies how often the meter synchronizes over SNTP. NOTE: This parameter is not used for NTP.
Event Logging Threshold (NTP and PTP only)	0.000001 to 1.000000	Specifies the minimum time difference (in seconds) for a time synchronization to be logged as an event. This parameter can be configured to help prevent the meter's event log from being flooded with time synchronization events.
NTP Server	Server IP address or domain name	Specifies the IP address (or fully qualified domain name if DNS is active) of the SNTP or NTP server.

8. If using serial GPS time synchronization, enter the following information under **Communications > Serial** settings:

Parameter	Description
Protocol	Select the GPS setting that matches your GPS receiver.
Baud rate	The recommended baud rate for GPS time synchronization is 9600 bps.
Serial port	The recommended stop bits/parity for GPS time synchronization is 8N1.

Configuring time information using the display

Use the meter's display to configure time parameters.

NOTE: If your device is installed in a region where DST is observed, it is recommended to use ION Setup to configure the time zone for your locale.

1. Press **Setup Menu > Date/Time/Clock Setup > Date & Time Setup**.
2. Configure your time and date formats, time zone offset, and daylight savings time offset. Press the down button to access the **Clock Setup** screen.
3. Configure the clock and time synchronization source, and the time synchronization time format.

Date and time setup

Parameter	Values	Description
Time Format	12 H, 24 H	Specifies how the time is displayed.
Date Format	MM/DD/YYYY, DD/MM/YYYY, YYYY/MM/DD	Specifies how the date is displayed.
TZ Offset	-12:00:00 to 13:00:00	Sets the time zone of the meter's location, relative to UTC.
DST Offset	-3:00:00 to 3:00:00	Sets the daylight savings time offset of the meter's location.

Clock setup

Parameter	Values	Description
Clock Source	Internal, Line Freq, COMM	Specifies the time synchronization source.
Time Sync Source	COM1, ETHERNET, ETHERNET - ION, ETHERNET - DNP, ETHERNET - PTP, IRIG-B	Specifies the port to receive time synchronization signals.
Time Sync Type	UTC, Local	Specifies whether time synchronization signals are received in local time or UTC.

Measurements

Energy

Your meter provides bi-directional, 4-quadrant, revenue accurate energy metering:

- kWh, kVARh, kVAh delivered and received
- kWh, kVARh, kVAh net (delivered minus received)
- kWh, kVARh, kVAh total (delivered plus received)
- Volt-squared-hours and amp-squared-hours
- Integration of any instantaneous measurement

Energy parameters can be logged automatically on a programmed schedule.

All energy values represent the total for all three phases.

Demand

Your meter supports several demand calculation methods, including block, rolling block, synchronized and predicted demand.

It can measure demand on any instantaneous value and record peak (maximum) demand with time and date information.

- kW, kVAR, kVA demand
- kW, kVAR, kVA peak demand
- Amps, Volts demand

Instantaneous measurements

Your meter provides one second and half-cycle true RMS readings.

Instantaneous readings include:

- 3-phase voltages (line-to-line, line-to-neutral): per phase and average
- 3-phase currents: per phase and average
- I4 current, measured
- Residual current, calculated (I calc res)
- Active (kW), reactive (kVAR) and apparent (kVA) power: per phase and total
- Power factor per phase and total
- System frequency
- Voltage and current unbalance
- Phase reversal

Harmonics

Your meter provides harmonic distortion metering, recording and real-time values for all voltage and current inputs.

- Individual harmonics (including magnitude, phase angle phase and inter-harmonics) up to the 63rd harmonic
- Total even harmonic distortion (TEHD), total odd harmonic distortion (TOHD)
- Total harmonic distortion (THD), total demand distortion (TDD)
- K-factor, Crest factor

Min/max recording

Your meter records new minimum and maximum data every recording interval for a variety of values.

- Voltage and current
- kW, kVAR and kVA
- Power factor
- Frequency
- Voltage unbalance

Power quality

Your meter monitors the voltage channels, detects and records power quality events.

The meter measures and records:

- Sag/swells: ITIC/CBEMA and SEMI curves

Power quality standards compliance:

- EN 50160
- IEC 61000-4-30 Class S
- IEEE 519

The meter supports advanced power quality features:

- Disturbance Direction Detection: the meter can capture sag/swell disturbances, analyze the information and determine the direction of the disturbance relative to the meter. Determining the source of a disturbance more quickly and accurately helps prevent repeat occurrences and minimize facility downtime.
- COMTRADE: the meter can save waveform data in COMmon format for TRAnsient Data Exchange (COMTRADE) format, which is available for download using an SFTP client application. This is intended for use in conjunction with IEC 61850.
- Setpoint learning: You can configure your meter to learn certain disturbance-related values, such as what constitutes a sag, swell, or high or low setpoint.

Power and power factor

The sampled measurements taken at the meter's voltage and current inputs provide data for calculating power and power factor.

In a balanced 3-phase alternating current (AC) power system source, the AC voltage waveforms on the current-carrying conductors are equal but offset by one-third of a period (a phase angle shift of 120 degrees between the three voltage waveforms).

Power factor (PF)

Power factor (PF) is the ratio of real power (P) to apparent power (S).

$$PF = \frac{P}{S}$$

PF is provided as a number between -1 and 1 or as a percentage from -100% to 100%, where the sign is determined by the convention.

A purely resistive load has no reactive components, so its power factor is 1 (PF = 1, or unity power factor). Inductive or capacitive loads introduce a reactive power (Q) component to the circuit which causes the PF to become closer to zero.

True PF and displacement PF

The meter supports true power factor and displacement power factor values:

- True power factor includes harmonic content.
- Displacement power factor only considers the fundamental frequency.

NOTE: Unless specified, the power factor displayed by the meter is true power factor.

Apparent, active, and reactive power (PQS)

Apparent power (S) is the capacity of your measured power system to provide active (real power, P) and reactive power (Q).

A typical AC electrical system load has both resistive and reactive (inductive or capacitive) components. Resistive loads consume real power (P). Reactive power (Q) is either consumed (inductive loads) or generated (capacitive loads).

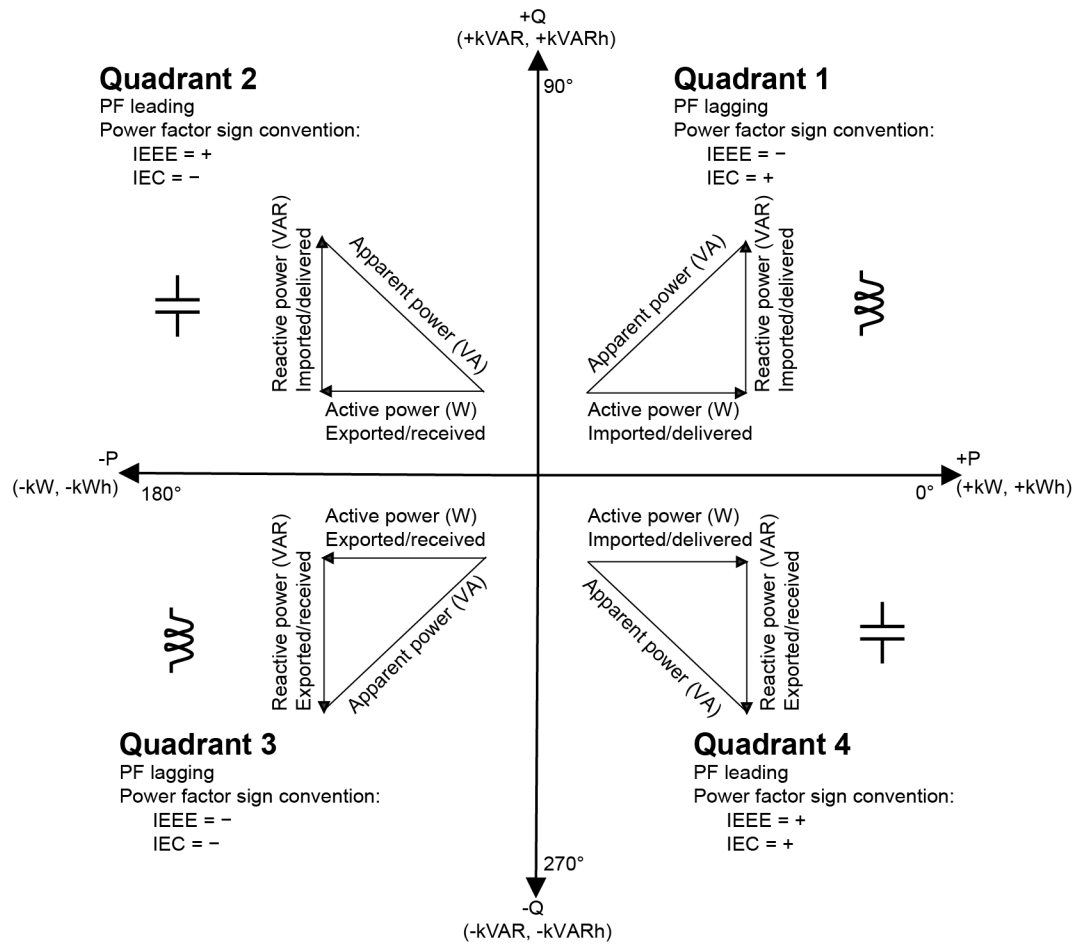

The units for power are watts (W or kW) for real power P, vars (VAR or kVAR) for reactive power Q, and volt-amps (VA or kVA) for apparent power S.

Positive real power P(+) flows from source to load, and negative real power P(-) flows from the load to the power source.

Current phase shift from voltage

Electrical current can lag, lead, or be in phase with the AC voltage waveform, and is typically associated with the type of load — inductive, capacitive or resistive.

For purely resistive loads, the current waveform is in phase with the voltage waveform. For capacitive loads, current leads voltage. For inductive loads, current lags voltage.

The following diagrams show how voltage and current waveforms shift based on load type under ideal (laboratory) conditions.

Current and voltage in phase (resistive)

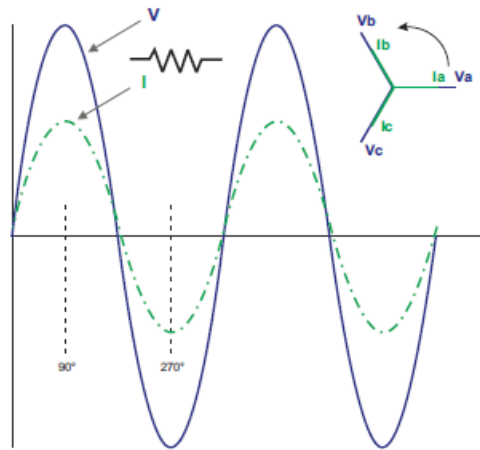

Current leads voltage (capacitive)

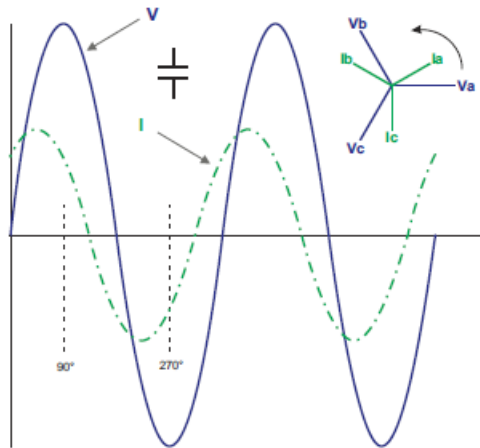

Current lags voltage (inductive)

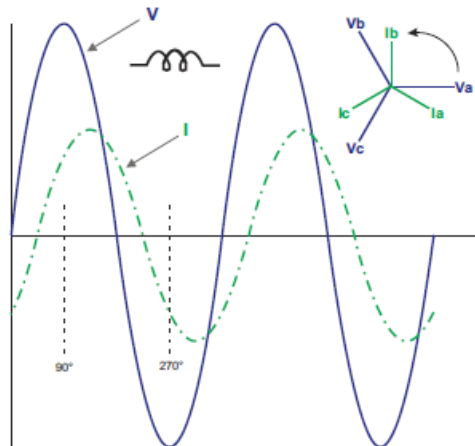

Power demand

Power demand is a measure of average power consumption over a fixed time interval.

NOTE: If not specified, references to demand are assumed to mean power demand.

The meter measures instantaneous consumption and can calculate demand using various methods.

Peak demand

Peak (or maximum) demand is the highest demand level recorded over the billing period.

Power utilities generally bill commercial customers based on their peak usage levels, called peak demand (in kW) and energy consumption (in kWh). Peak (or maximum) demand is the highest demand level recorded over the billing period. You can view peak demand values on your meter's display.

Your meter calculates the average current demand and kW, kVAR and kVA demand using sliding window demand methods. It supports coincident demand values when a peak demand is detected.

Your meter's default configuration is suitable for most applications, or you can customize it for your specific application. You can configure the minimum time between consecutive demand resets.

NOTE: If not specified, references to demand are assumed to mean power demand.

Peak demand reset lockout

The demand reset lockout time sets the minimum time allowed between consecutive demand resets; the meter ignores any attempts to reset demand that occur within the lockout period.

The peak demand reset lockout period is user-configurable (typical default value is 25 days).

See the ION Setup online help for instructions on how to configure demand peak and the demand reset lockout period on your meter.

See *ION Reference*, available from www.se.com, for detailed information on how Sliding Window Demand modules measure and calculate demand values.

Sliding window demand

To calculate demand values, your meter uses the sliding window averaging (or rolling interval) method which divides the demand interval into a set number of subintervals of specified duration.

The demand is measured based on the average load level over the most recent set of subintervals. Sliding window demand also provides predicted demand values.

Examples of sliding window demand

This example shows two different ways of configuring a 15-minute demand interval:

- Single interval (also called block or timed block): the 15-minute demand interval is defined as a single subinterval with a duration of 15 minutes.
- Sliding window (also called rolling block): the 15-minute demand interval is defined as three subintervals with a duration of 5 minutes each. This method offers better response time than a single interval.

Single interval (block)

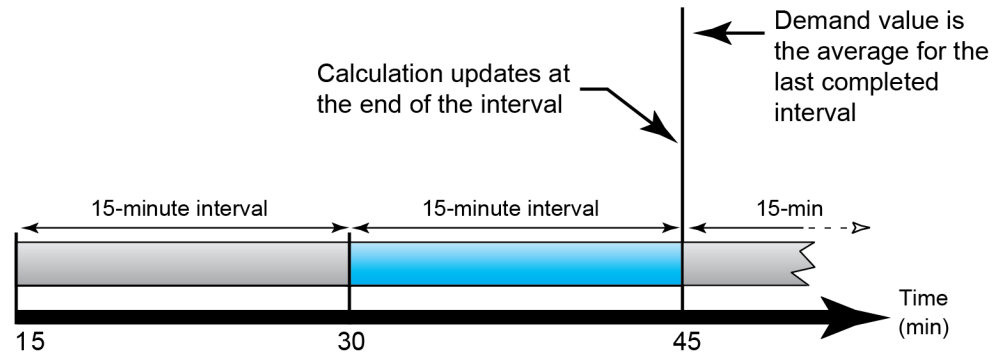

Sliding window (rolling block)

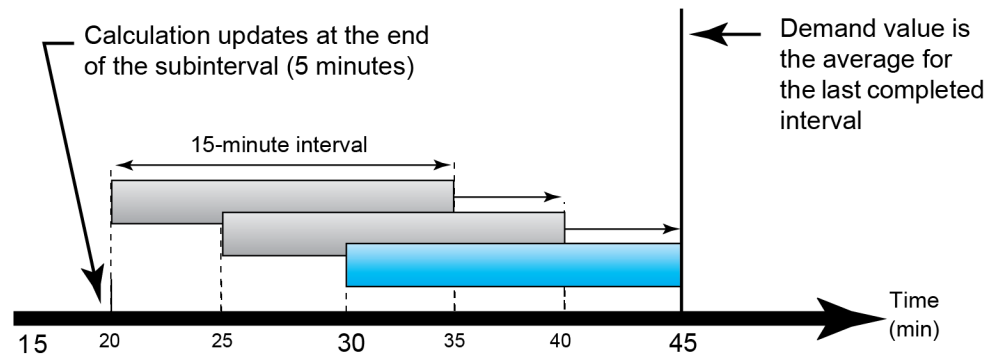

Incremental energy

Incremental energy allows you to define a start time, end time, and the time interval (increments) for incremental energy accumulation.

At the end of each interval, the energy accumulated during that period is stored. By default, the meter only records the previous interval's incremental energy and the instantaneous energy accumulations in the active interval.

The first interval of incremental energy accumulation begins at the specified start time. Incremental energy ends at the specified end time, which may result in a truncated interval if the interval duration does not divide evenly into the overall incremental energy duration. For example, an interval duration of three hours with an overall duration of five hours truncates the last interval duration to two hours. The latest value for the specified end time is midnight (24:00).

Your start time must be before the end time and after midnight, and the period over which incremental energy is accumulated cannot include midnight. This is because your meter's start and end times are defined relative to midnight.

Start: 6AM, End: 12AM, interval: 3 hrs	Incremental energy accumulates from 6AM to midnight in intervals of 3 hours.
Start: 6AM, End: 2AM, interval: 3 hrs	Incremental energy will not function. End time must be after start time and before or equal to midnight.

Incremental energy helps provide information for analyzing energy and power usage against present or future utility rates, and is useful for measuring energy consumption by shift or for a specific process.

When configuring incremental energy, shorter incremental energy periods provide more granular data which can make the data easier to use for comparison purposes.

Example: Incremental energy

- Start time: 8AM or 08:00
- End time: 12AM or 24:00
- Interval: 420 minutes (7 hours)

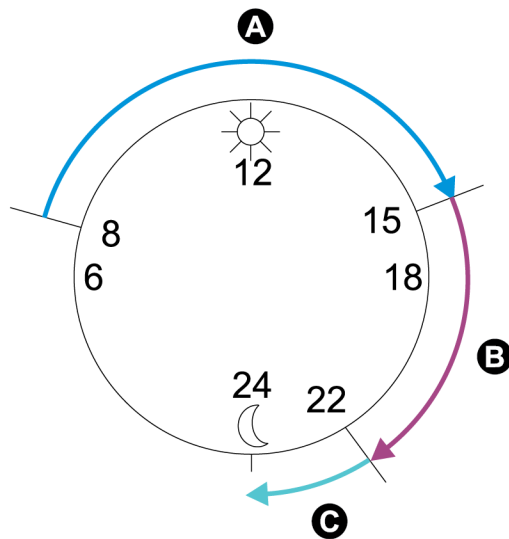

A	First interval (08:00 to 15:00)
B	Second interval (15:00 to 22:00)
C	Third interval (22:00 to 24:00)

The first incremental energy interval is from 8AM (start time) to 3PM, and is 7 hours long. The second incremental energy interval is from 3PM to 10PM, and is also 7 hours long. The third interval is from 10PM to 12AM, and is only 2 hours long because 12AM is the specified end time. These intervals repeat every 24 hours until the configuration is changed or incremental energy feature is disabled.

Configuring incremental energy using ION Setup

You can configure incremental energy using ION Setup.

1. Start ION Setup.
2. Open the **Setup Assistant** for your meter.
3. Click **Energy Applications > Incremental Energy**.

4. Select **Status** and click **Edit**. The **Incremental Energy Setup** screen is displayed.
5. Select **Enable** to display parameters for configuration.
6. Select the parameter to configure.

NOTE: Configuring any parameter resets the incremental energy values recorded by your meter.

Parameter	Range	Description
Start time	12:00 am to 11:59 pm	The incremental energy first interval's start time. The start time must be prior to the end time for energy accumulation.
End time	12:01 am to 12:00 am	The end time for incremental energy. The end time must be after the start time and be less than or equal to 12AM (midnight).
Interval duration	Configurable	The increment period for the incremental energy duration.

7. Click **OK** to save your changes.

Conditional energy

Conditional energy allows you to define an accumulation period for real and reactive energy using one of your meter's digital inputs.

You can use conditional energy to track four-quadrant accumulated energy during a specific period. For example, you can track accumulated energy values during a particular process that is controlled by a programmable logic controller (PLC).

Conditional energy is accumulated until it is reset. The conditional energy reset date and time information is stored in the meter's event log.

Configuring conditional energy using ION Setup

You can enable and configure conditional energy settings using ION Setup.

When configuring your meter, the configuration interface may show all of the possible ports, regardless of what is physically available on your meter.

One of your device's digital inputs must be connected and configured to define when conditional energy is accumulated.

1. Start ION Setup.
2. Open the Setup Assistant for your meter.
3. Click **Energy Applications > Digital Input Based**. Review the digital inputs assigned to applications to help ensure there are no conflicting usages.
4. Select **Conditional Energy** and click **Edit**. The Conditional Energy Setup screen is displayed.
5. Click **Enabled** to enable the conditional energy feature.

- Click **Select** to define the digital input. The input's state determines whether conditional energy is accumulated. When this digital input is on, conditional energy is accumulated.

NOTE: It is recommended to set **Assigned Input** to No Connection to disable the conditional energy feature by removing any port associations.

- Click **OK** to save your configuration.

Trending and forecasting overview

Trending and forecasting is a feature on your device that predicts the next set of measured or calculated data by plotting and analyzing trends in historical data.

Trending and forecasting data is a useful tool to help analyze changes in load and power quality and forecasting values such as demand. For your meter's trending and forecasting feature to work, you only need to give the meter time to accumulate data.

See *ION Reference*, available from www.se.com, for more information about the Trending and Forecasting module.

Trending and forecasting implementation

Data used for trending and forecasting is logged for specific intervals:

- Every hour for the last 24 hours
- Every day for the last month
- Every week for the last 8 weeks
- Every month for the last 12 months

The following parameters are configured for trending and forecasting using ION Setup:

kW sd del-rec (demand)	Freq (frequency)
VII ab	I a mean
VII bc	I b mean
VII ca	I c mean
VII avg	I avg mean

You can configure the start day of the week for trending and forecasting using the **Clock** setup assistant in ION Setup.

Viewing trending and forecasting data on your meter's webpages

You can select data for forecasting and trending and view the resulting information using your meter's webpages.

For trending and forecasting to operate, your meter must have accumulated data for at least two of the specified intervals; for example, if you want to view a daily graph, your meter must have accumulated data for at least two previous days before the present day.

1. Log in to your meter's webpages.
2. Click **Monitoring > Trending & Forecasting**.
3. Select the **Target** and **Interval**. The graph for the selected data is displayed.

Resets

Resets overview

Resets allow you to clear accumulated parameters stored on your meter, reinitialize the meter or reinitialize meter accessories.

Meter resets clear your meter's onboard data logs and other related information. Resets are typically performed after you make changes to the meter's basic setup parameters to clear invalid or obsolete data to prepare the meter for active service.

NOTE: Revenue-locked meters must be unlocked to perform resets that impact revenue data. See "Revenue locking your meter" on page 258 for more information.

Option modules reset

Perform an option module reset if your option modules are not communicating with your meter.

During an option module reset, the option module may not operate normally, and digital and analog outputs may change state.

WARNING

UNINTENDED OPERATION

Do not use this device for critical control or protection of persons, animals, property, or equipment.

Failure to follow these instructions can result in death, serious injury, or equipment damage.

You can reset your meter's option module bus using ION Setup or the display. This power cycles all the modules attached to your meter. If you have queued firmware updates for option modules on your meter's internal SFTP site, the firmware updates are performed.

By default, your meter is configured to automatically perform an option module bus reset to help keep the option modules operating normally. Contact Technical Support for instructions on changing this default configuration.

Available resets

You can perform meter resets using ION Setup, the meter webpages or the display.

Reset	Description
Master Reset	<ul style="list-style-type: none"> Clears all cumulative and derived quantities from the meter, including: demand, peak demand, energy, and revenue parameters. Clears meter event and waveform logs. Clears COMTRADE waveform records stored in the meter's internal SFTP site. Clears meter data logs.
Peak Demand Reset	Clears meter peak demand values. NOTE: The peak demand reset has a lockout period that sets the minimum time allowed between consecutive resets.
Min/Max Reset	Clears maximum and minimum values stored in the meter.
Digital Input Count Reset	Clears the digital input status change counters.
Harmonics Min/Max Reset	Clears maximum and minimum harmonics values stored in the meter.
Disturbance Count Reset	Clears the sag/swell event counter. The sag/swell event counter counts the number of sag/swells that have occurred since the last reset or meter power-up.
EN50160 Reset	Clears all EN 50160 parameters and statistics accumulated in the meter.
Option Modules Reset	Resets communications to expansion modules connected to the meter.
Conditional (Cnd) Energy Reset	Clears the conditional energy values stored in the meter.
Input Metering Reset	Clears the input metering values stored in the meter.

Resetting the meter using ION Setup

You can reset the meter using ION Setup.

Revenue-locked meters must be unlocked to perform resets that impact revenue data.

Meter resets clear the meter's onboard data logs and other related information.

NOTICE

DATA LOSS

Ensure all important data from the device is saved before performing a reset.

Failure to follow these instructions can result in data loss.

To reset the meter using ION Setup:

1. Start ION Setup.
2. Open the **Setup Assistant** for your meter.
3. Click **Verification**.
4. Select **Normal Mode** and click **Display**.
5. Select the desired tab in the **Normal Mode** dialog box. Depending on the tab selected, different resets are available.

Tab	Reset available
Energy	Master Reset
Rolling Demand	Peak Reset Master Reset
Volts, Amps and Power	Master Reset
Conditional Energy	Cnd Reset Master Reset
Input Metering	IM(n) Reset NOTE: n is the input metering number, for example IM1.

6. Click the appropriate button to perform the reset. For some resets, the meter indicates that the reset is in progress.

NOTE: Do not configure or power down your meter until it indicates that the reset is complete or some parameters may not be completely reset.

Resetting the meter using the meter webpages

You can reset the meter using the meter webpages.

Meter resets clear the meter's onboard data logs and related information.

NOTICE

DATA LOSS

Ensure all important data from the device has been retrieved before performing a reset.

Failure to follow these instructions can result in data loss.

To reset the meter using the meter webpages:

1. Connect to your meter's webpages.
2. Browse to **Control > Resets**.

- Click **Reset** for the values you want to clear.

Parameter	Description
Master Reset	<ul style="list-style-type: none"> – Clears all cumulative and derived quantities from the meter, including: demand, peak demand, energy, and revenue parameters. – Clears meter event and waveform logs. – Clears COMTRADE waveform records stored in the meter's internal SFTP site. – Clears meter data logs.
Peak Demand Reset	<p>Clears meter peak demand values.</p> <p>NOTE: The peak demand reset has a lockout period that sets the minimum time allowed between consecutive resets.</p>
Min/Max Reset	Clears all accumulated maximum and minimum values stored in the meter.
Digital Input Count Reset	Clears the digital input status change counters.
Harmonics Min/Max Reset	Clears all accumulated maximum and minimum harmonics values stored in the meter.
Disturbance Count Reset	Clears the sag/swell event counter. The sag/swell event counter counts the number of sag/swells that have occurred since power-up or the last reset to provide power quality information to energy management systems.
EN50160 Reset	Clears all EN50160 parameters and statistics accumulated in the meter.

Resetting the meter using the display

You can reset the meter using the display.

Revenue-locked meters must be unlocked to perform resets that impact revenue data.

Your meter's digital and analog outputs may change state or may not function during resets.

WARNING

UNINTENDED OPERATION

Do not use this device for critical control or protection of persons, animals, property, or equipment.

Failure to follow these instructions can result in death, serious injury, or equipment damage.

Meter resets clear the meter's onboard data logs and related information.

NOTICE

DATA LOSS

Ensure all important data from the device has been retrieved before performing a reset.

Failure to follow these instructions can result in data loss.

To reset the meter using the display:

1. Press the **Home** button on the display.
2. Press **Setup Menu > Resets**.
3. Press the Edit button. Enter your meter's username and password.
4. Press the up or down icons to navigate available resets. A gray bar appears behind the active selection.

Reset	Description
Master Reset	<ul style="list-style-type: none"> – Clears all cumulative and derived quantities from the meter, including: demand, peak demand, energy, and revenue parameters. – Clears meter event and waveform logs. – Clears COMTRADE waveform records stored in the meter's internal SFTP site. – Clears meter data logs.
Peak Demand Reset	<p>Clears meter peak demand values.</p> <p>NOTE: The peak demand reset has a lockout period that sets the minimum time allowed between consecutive resets.</p>
Min/Max Reset	Clears all accumulated maximum and minimum values stored in the meter.
Digital Input Count Reset	Clears the digital input status change counters.
Harmonics Min/Max Reset	Clears all accumulated maximum and minimum harmonics values stored in the meter.
Disturbance Count Reset	Clears the sag/swell event counter. The sag/swell event counter counts the number of sag/swells that have occurred since power-up or the last reset to provide power quality information to energy management systems.
EN50160 Reset	Clears all EN 50160 parameters and statistics accumulated in the meter.
Option Modules Reset	Resets communications to expansion modules connected to the meter.

5. Press the up and down buttons simultaneously.
6. Press the Select icon to accept the change.

When you select **Master Reset**, the message `all recorded data will be lost.
Reset selected parameters?` is displayed.

7. Press Select icon to confirm.

Firmware upgrades

Firmware upgrades overview

It is recommended to upgrade PowerLogic™ PM8000 advanced power quality meters to the latest firmware version.

Firmware version pre-v2.1.0

Before upgrading to the latest firmware version, firmware version 2.1.0 must have been previously installed. Go to www.se.com, and then search for *Upgrading Meter Firmware to v2.1.0* for information on that upgrade.

TIP: Firmware version can be identified using ION Setup, meter webpages, or the display.

Meter firmware includes a digital signature which helps ensure authenticity.

Obtaining meter upgrades

To find a recent firmware package, search for your meter type and Firmware and Associated Files.

Download the firmware upgrade package (ZIP) from www.se.com.

Upgrade information

Meter firmware

A meter that is upgraded to firmware version 3.0.0 or later cannot be downgraded to an earlier firmware version.

NOTICE

LOSS OF DOWNGRADE CAPABILITY

Do not upgrade to firmware version 3.0.0 or later if you need to downgrade the meter in the future.

Failure to follow these instructions can result in loss of firmware downgrade functionality.

Upgrade agent

After upgrading the meter firmware to v2.2.1 or later, the previous upgrade agent cannot be re-applied.

Restart requirement

Meter restart is required.

Legacy security support

Legacy security support is an interim solution for users that use Standard security mode and is the default setting for new meters. It provides backwards compatibility with older software communicating with the meter using ION protocol.

If Standard security was used before upgrading meter firmware to v3.0.0, Legacy security support is enabled.

If Advanced security was used before upgrading meter firmware to v3.0.0, Advanced security is enabled.

RECOMMENDATION: Use Advanced security mode.

Legacy security support username	Legacy security support password	Legacy security support password range	Legacy security support password limit
User1	<ul style="list-style-type: none"> Same password used before upgrade to firmware version 3.0.0., or 0 (zero) for new meters. 	0–99999999	8 characters

Switch ION Setup into Advanced mode to setup multiple user accounts for meters using Legacy security support: Open ION Setup > Ctrl + click on the meter to select it.

Meter firmware upgrade prerequisites

Perform back ups of all meter data, download latest ION Setup, and check the connection requirements before upgrading.

Ensure that the firmware version you are upgrading to is compatible with your meter and the version number is greater than your existing firmware.

Back up custom meter webpages

Back up webpage files if they were customized.

The upgrade process overwrites all existing meter webpages.

NOTICE

LOSS OF CUSTOM WEBPAGES

Back up custom webpages before upgrading the meter firmware.

Failure to follow these instructions can result in loss of custom webpage functionality.

To back up meter webpages, copy the **web** folder to a local folder on the computer using an SFTP client application.

Back up custom meter frameworks

Back up the meter template if the meter uses a customized meter template or frameworks.

The upgrade process overwrites all existing meter frameworks.

NOTICE

LOSS OF CUSTOM FRAMEWORKS

Back up custom frameworks before upgrading the meter firmware. The upgrade process overwrites existing meter frameworks.

Failure to follow these instructions can result in loss of custom framework functionality.

Back up accumulated energy values

Record the accumulated energy values on the meter before upgrading. Re-enter these values after the upgrade. See "Editing accumulated energy values using ION Setup" on page 254.

Download latest ION Setup

To upgrade meter firmware, the most recent version of ION Setup is required.

1. Start ION Setup.
2. Click **Help > About ION Setup** to determine your ION Setup version.
3. Open a web browser and go to https://www.se.com/en/download/document/ION_Setup_Latest_Release/ to locate the latest version of ION Setup.
4. If you do not have the most recently released version, download the installation file, then run it to upgrade ION Setup.

Connection requirements

- Use a direct Ethernet TCP connection to prevent delays and upgrade failure risks associated with slower communications connection methods. You cannot perform certain firmware updates over serial or Ethernet gateway.
- The display, webpages and option module firmware updates require an SFTP over Ethernet connection.
- Use a computer connected to the same Ethernet network as the meter (physically or through a remote desktop connection).
- To upgrade option module firmware, the option module(s) must be connected to the meter.

Meter firmware upgrades

Use individual files such as UPX, BIN and S19 file formats to upgrade or use the firmware upgrade ZIP file with ION Setup (recommended).

Do not interrupt the upgrade process until all updates are complete.

NOTICE

UPGRADE FAILURE

Do not interrupt the upgrade process or disconnect the meter or any connected components while ION Setup is performing the firmware upgrades.

Failure to follow these instructions can result in loss of meter functionality.

Option 1 (recommended) – Upgrading using ZIP file

This is the recommended method of upgrading your meter. This method can also be used for sequential device upgrades.

Any digital and analog outputs associated with your device may change state during a firmware upgrade.

⚠ WARNING

UNINTENDED OPERATION

Do not use this device for critical control or protection of persons, animals, property, or equipment.

Failure to follow these instructions can result in death, serious injury, or equipment damage.

Loading firmware or template onto your meter clears the meter's recorded data.

NOTICE

DATA LOSS

Ensure that all important data has been recorded before uploading firmware or a template to your device.

Failure to follow these instructions can result in data loss.

1. Start ION Setup.
2. Open the **Setup Assistant** for your meter.
3. Click **Template > Upgrade**.
4. Click **Upgrade** and navigate to the saved upgrade ZIP file.
5. Select the upgrade ZIP file and click **Open**. The **Compressed Device Upgrade Package** window displays the updates to be installed in the order listed.

NOTE: Click the **View What's New PDF** link to read about new and updated features related to the firm upgrade.

6. Select the components you want to upgrade. For example:

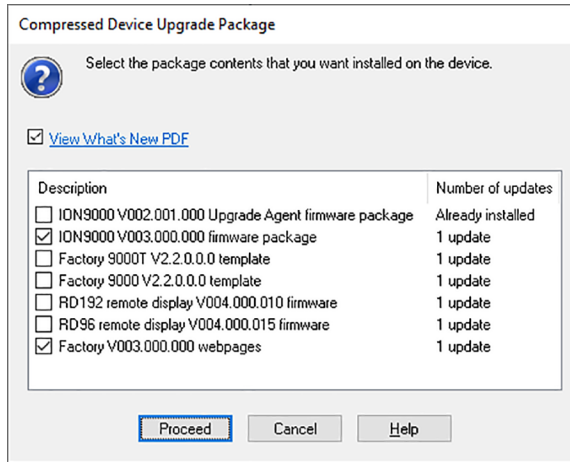

- **PM8000 firmware V3.0.0 package** to be applied in the order listed:
 - UpgradeAgent_V002.001.000.upx (not required if already applied)
 - v003.000.000.upx
- **Factory V2.2.0.0.0 template** is the meter template that is programmed to the meter after the firmware upgrade is complete.
- **Factory V3.0.0 web pages** are the files to be uploaded to the meter's **web** SFTP folder, to update the meter webpages with firmware-related changes.

7. Select the desired settings and readings to be retained, if you selected a template component:

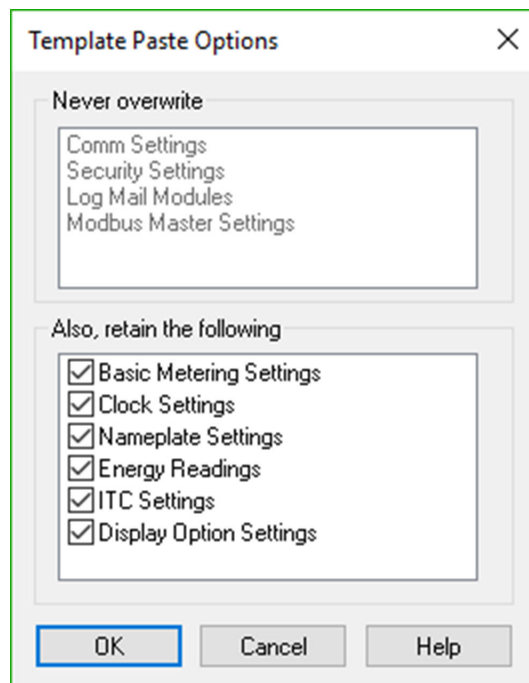

8. Click **OK**.

9. Click **Proceed** to start the upgrade process.
10. Confirm upgrade status is complete and upload webpages to the meter. See "Status" on page 251 for details.

Option 2 – Upgrading using individual upgrade files

Refer to the “Firmware and templates” section in the meter’s user manual for detailed instructions on how to upgrade the meter, display and option module firmware.

1. Follow tasks in the order listed:
 - a. UpgradeAgent_V002.001.000.upx
 - b. V003.000.000.upx

To retain your meter settings, select a meter template file (DCF) to paste into the meter when performing a and b firmware upgrades. Use the **Template Paste Options** box to specify the settings to retain after the upgrade.

NOTICE

LOST SETTINGS

Always select a template file when upgrading the meter firmware.

Failure to follow these instructions can result in loss of meter settings.

2. Confirm upgrade status is complete and upload webpages to the meter. See "Status" on page 251 for details.

Status

After all required meter firmware updates are complete, ION Setup continues to perform the remaining updates.

- If you selected to upgrade the template, ION Setup will paste the template into the meter.
- If you selected to upgrade PM89RD96 remote display firmware, ION Setup will perform the display upgrade through the connected DIN rail-mounted meter.

Upgrading display firmware

See the *Upgrade PM89RD96 display firmware to v4.0.15* technical note, available from www.se.com, for details.

Upgrading option module firmware

You can upgrade option module using ION Setup or directly through the meter's internal SFTP site.

1. Go to www.se.com and search for the METSEPM89M0024 or METSEPM89M2600 firmware file.
2. Download the firmware file.

Loading option module firmware using ION Setup

Upload firmware to option modules using ION Setup over an Ethernet connection. Each option module must be upgraded individually.

Prerequisites:

- Option module firmware upgrade (.S19) file(s). Go to www.se.com to download upgrade files.
- Option module is connected to the meter.
- Access to meter's internal SFTP site.

Digital and analog outputs may change state during a firmware upgrade. Option modules are offline during an option module firmware upgrade; they will not communicate to the meter and the outputs may change state during the upgrade process.

WARNING

UNINTENDED OPERATION

Do not use this device for critical control or protection of persons, animals, property, or equipment.

Failure to follow these instructions can result in death, serious injury, or equipment damage.

If your meter's option module loses power during firmware upload, the option module will revert to its original firmware and you will have to reload the firmware file.

To load firmware option module firmware using ION Setup:

1. Obtain the Option Module firmware files (.S19) that you want to load onto your option module(s). Save the files where they can be accessed by the computer running ION Setup.
2. Start ION Setup.
3. Open the **Setup Assistant** for your meter.
4. Select the **Template** screen.
5. Click the **Upgrade** tab, then click **Upgrade**. Enter your meter's password if prompted and click **OK**.
6. Navigate to where you have stored the option module firmware. Select the Option Module firmware file (*.S19) as the file type.
7. Select the option module firmware file and click **Open**.

An ION Setup window will open. Click **Yes** to confirm the firmware upgrade.

8. The Option Card Upgrade window opens. Select the Slot that corresponds to the Option Module type. You can select multiple slots for the same option module type.
9. Click **Start**.

A dialog box describes the firmware upgrade progress, verifies the firmware, and finishes with an overview stating whether the firmware was successfully uploaded.

Loading option module firmware using SFTP

Upload firmware to your meter's option modules by loading the firmware upgrade file onto your meter's internal SFTP site. Each option module must be upgraded individually.

Prerequisites:

- Option module firmware upgrade (.S19) file(s). Go to www.se.com to download upgrade files.
- Option module is connected to the meter.
- Access to meter's internal SFTP site.

The meter's digital and analog outputs may change state during a firmware upgrade. Option modules are offline during an option module firmware upgrade. They will not communicate to the meter and the outputs may change state during the upgrade process.

WARNING

UNINTENDED OPERATION

Do not use this device for critical control or protection of persons, animals, property, or equipment.

Failure to follow these instructions can result in death, serious injury, or equipment damage.

NOTE: If your meter's option module loses power during firmware upload, the option module will revert to its original firmware and you will have to reload the firmware file.

To load firmware option module firmware using SFTP:

1. Connect to your meter's internal SFTP site.
2. Open the (optionModuleUpg) folder.
3. Open the option module folder that applies to the module to be upgraded.
4. Drag the option module firmware file into the option module upgrade folder.
The file is immediately transferred to the option module, and is not stored on the meter.
5. Review the option module firmware upgrade details stored in the meter's event log to confirm that the upload was successful. The upgrade folder must match the position of the option module (A through D).

Maintenance

Maintenance overview

The meter does not contain any user-serviceable parts. If the meter requires service, contact your local Schneider Electric Technical Support representative.

NOTICE

METER DAMAGE

- Do not open the meter case.
- Do not attempt to repair any components of the meter.

Failure to follow these instructions can result in equipment damage.

Do not open the meter. Opening the meter voids the warranty.

Editing accumulated energy values using ION Setup

You can edit energy values such kWh and kVARh using ION Setup.

NOTE: Ensure you have recorded accumulated energy values before upgrading your meter's firmware. You can then re-enter these values after the upgrade.

NOTE: Revenue-locked meters must be unlocked before accumulated energy values can be edited. See "Revenue locking your meter" on page 258 for more information

1. Start ION Setup.
2. Open the **Setup Assistant** for your meter.
3. Click **Template**.
4. Click the **Register Edit** tab, click **Energy** then click **Display**. Enter your meter's password (if prompted) and click **OK**.

The Register Editor screen displays.

5. Click **Edit** to enable editing.
6. Enter values for kWh, kVAh and kVARh as required. Click **Send** to finish.

NOTE: Only values that have the check box selected will be sent to the meter.

7. Click **Close** to close the Register Editor screen.

Device-specific information

Manufacturing-related information about the meter is available from the Factory module or through Modbus commands.

The meter's Factory module stores meter details such as device type, serial number, and vendor name. You can use ION Setup in advanced mode to view the contents of the Factory module's setup registers. Similarly, you can use Modbus commands to read the Modbus registers mapped to the corresponding Factory module's registers.

NOTE: Not all ION device setup registers are mapped to Modbus registers by default.

Other device-specific details, such as Product Code, are not stored in the Factory module. Product Code (also known as Modbus Product ID) is a number that the manufacturer assigned to a product to uniquely identify it, for use by systems that specifically require this information. You can use the device's Modbus map and Modbus commands to read the Modbus Product ID.

See *ION Reference*, available from www.se.com, for more information on the Factory module.

Revenue

A revenue meter provides, over a defined range of operating conditions, measurements that are within international and national defined standards and industry-accepted accuracy limits.

It also provides protection against unauthorized alteration of these measured quantities. National and utility-based standards regulate protection against unauthorized alteration of measured quantities.

Revenue metering components

To meet government regulations and utility security requirements, the meter incorporates three types of security systems:

- Traditional anti-tamper mechanical seals on the meter. See your device installation guide.
- Passcode entry to reset meter values, for example, Master reset.
- Hardware locking mechanism that prevents modification of revenue quantities after they are locked.

Revenue firmware security features

Your revenue meter has additional firmware security features:

- You can only upgrade to revenue-qualified firmware and frameworks.
- Your firmware upgrades are recorded in your meter's event log. An additional firmware upgrade log is stored on your meter. Contact Technical Support for information on upgrade log retrieval.
- When revenue-locked, you cannot perform resets, configure some revenue-specific parameters or upgrade your meter.

Protected features and settings

Your revenue meter has features and settings that cannot be changed while revenue-locked.

In order to prevent changes to revenue-related features, settings and meter data, you can apply revenue-locking after all revenue-metering setup is complete. See the *ION Device Template Reference*, available from www.se.com, for a complete listing of revenue-locked features and settings.

Revenue locking

Revenue locking may be required to help meet government regulations and utility security requirements.

Revenue locking your meter helps:

- Prevent changes to revenue-related features, settings and meter data.
- Prevent tampering with your meter's voltage and current connections.
- Ensure the validity of revenue data.

See the *ION Device Template Reference*, available from www.se.com, for a complete listing of revenue-locked features, settings and meter data.

See the meter's catalog pages, available from www.se.com, or consult your local Schneider Electric representative for information about your device, its options and accessories.

Revenue-locking summary

You must configure and revenue lock your meter before installing it.

- Unlock your revenue meter if it is locked.
- Configure the required revenue settings specific for installation.

NOTE: If you are using ION Setup to configure your meter, allow for any communication delays before removing power to your meter.

- Verify the revenue settings have been implemented.
- Clear all accumulated meter data.
- Revenue lock your meter.
- Verify the meter is revenue-locked.
- Install the meter and install the terminal covers according to your meter's installation guide.

Revenue lock switch

The revenue lock switch located on the meter base is used to revenue lock your meter.

This switch is accessed through a sealable cover.

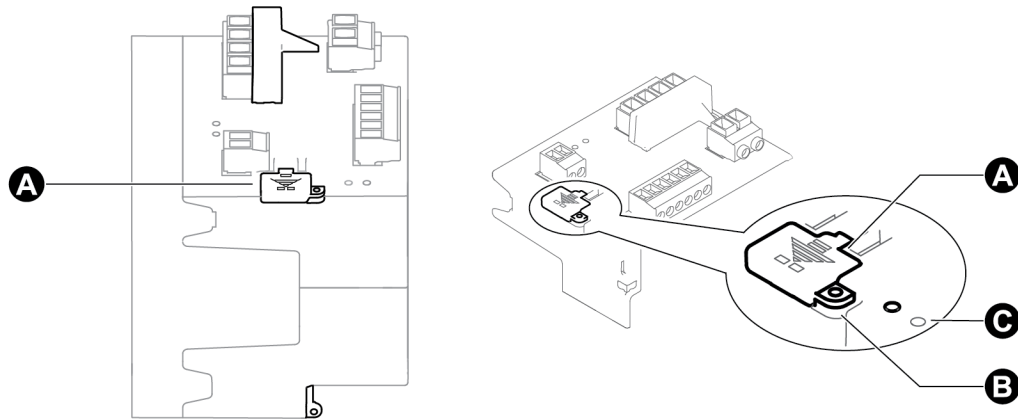

A	Revenue lock switch cover
B	Sealing point
C	Revenue LED

Revenue lock LED behavior

The revenue lock LED indicates the lock status of the meter.

LED behavior	Revenue lock status
Off	The meter is not revenue locked.
On	The meter is revenue locked.
Flashing	New revenue lock state is pending; power cycle your meter to set the revenue lock to on or off.

Revenue locking your meter

You can lock and unlock your meter using the revenue lock switch located on the meter base.

DANGER

HAZARD OF ELECTRIC SHOCK, EXPLOSION OR ARC FLASH

- Apply appropriate Personal Protective Equipment (PPE) and follow safe electrical work practices. See NFPA 70E, CSA Z462 or other local standards.
- Turn off all power supplying this device and the equipment in which it is installed before working on or in the equipment.
- Always use a properly rated voltage sensing device to confirm that all power is off.

Failure to follow these instructions will result in death or serious injury.

1. Open the revenue lock switch cover.
2. Locate the revenue lock switch.
3. Toggle revenue lock switch on or off.
4. Close the revenue lock switch cover and make sure it is firmly in place.
5. Seal the revenue lock switch cover if required.

Anti-tamper sealing

The meter has several anti-tamper sealing points which can be sealed by a wire seal or lock.

In certain countries, the meter is no longer revenue certified if the anti-tamper seals are broken.

See your meter's installation guide for sealing point locations.

NOTICE

LOSS OF COMPLIANCE

Re-certify your meter with the appropriate revenue metering authorities if you remove the anti-tamper seals.

Failure to follow these instructions may render your device non-compliant for billing purposes.

PT/CT correction

Potential transformer/current transformer correction (PT/CT correction), also called instrument transformer correction, can help reduce the need to replace transformers in installations where high accuracy is required.

The primary application for PT/CT correction is to apply correction factors for ratio errors and phase angle errors to instrument transformers. PT/CT correction is done for each current and voltage input to the meter and only affects 1-second power meter data and values derived from it, such as energy or demand. No high-speed, harmonics or waveform values are affected by the correction.

NOTE: For those familiar with ION architecture, the relevant 1-second Power Meter module outputs are compensated using the Instr Xformer (ITC) Correction module. All other modules that use the 1-second Power Meter module's data are also compensated.

See the ION Setup online help, available from www.se.com, for instructions on how to configure PT/CT correction on your device.

See *ION Reference*, available from www.se.com, for detailed information about the Instr Xformer Correction (ITC) module and how it applies PT/ CT correction to your device.

Time of use

Time of Use (TOU) is often used when a utility has set up schedules with different rates based on time of day, type of day and date when energy is consumed.

You can view the TOU active rates and seasons using the display.

See the ION Setup online help, available from www.se.com, for instructions on how to configure TOU on your meter.

See *ION Reference*, available from www.se.com, for a description of the Time of use module and its settings.

Energy pulsing LED behavior

The visible and infrared LEDs are configured by default to pulse based on energy measured by the meter.

You can configure the pulse weight (pulses per kWh) and the energy source.

Energy pulsing is used to help verify the energy measurement accuracy of your meter for revenue purposes.

Verifying accuracy

Verifying accuracy overview

All meters are tested and verified at the factory in accordance with International Electrotechnical Commission (IEC) and American National Standards Institute (ANSI) standards.

Your digital power meter typically does not require re-calibration. However, in some installations a final accuracy verification of the meters is required, especially if the meters will be used for revenue or billing applications.

For a list of accuracy standards that your meter complies to, contact your local Schneider Electric representative or download the meter brochure from www.se.com.

Accuracy test requirements

The most common method for testing meter accuracy is to apply test voltages and currents from a stable power source and compare the meter's readings with readings from a reference device or energy standard.

Signal and power source

The meter maintains its accuracy during voltage and current signal source variations but its energy pulsing output needs a stable test signal to help produce accurate test pulses. The meter's energy pulsing mechanism needs approximately 10 seconds to stabilize after every source adjustment.

The meter must be connected to control power in order to conduct accuracy verification testing. Refer to your meter's installation documentation for power supply specifications.

DANGER

HAZARD OF ELECTRIC SHOCK, EXPLOSION, OR ARC FLASH

Verify the device's power source meets the specifications for your device's power supply.

Failure to follow these instructions will result in death or serious injury.

Control equipment

Control equipment is required for counting and timing the energy pulse outputs from a visible LED, infrared LED or onboard digital output.

- Most standard test benches have an arm equipped with optical sensors to detect LED pulses (the photodiode circuitry converts detected light into a voltage signal).
- The reference device or energy standard typically has digital inputs that can detect and count pulses coming from an external source (i.e., the meter's onboard digital output).

NOTE: The optical sensors on the test bench can be disrupted by strong sources of ambient light (such as camera flashes, florescent tubes, sunlight reflections, floodlights, etc.). This can cause test errors. Use a hood, if necessary, to block out ambient light.

Environment

The meter should be tested at the same temperature as the testing equipment. The ideal temperature is about 23 °C (73 °F). Make sure the meter is warmed up sufficiently before testing.

A warm-up time of 30 minutes is recommended before beginning energy accuracy verification testing. At the factory, the meters are warmed up to their typical operating temperature before calibration to help ensure that the meters will reach their optimal accuracy at operating temperature.

Most high precision electronic equipment requires a warm up time before it reaches its specified performance levels. Energy meter standards allow the manufacturers to specify meter accuracy derating due to ambient temperature changes and self-heating.

Your meter complies with and meets the requirements of these energy metering standards.

For a list of accuracy standards that your meter complies with, contact your local Schneider Electric representative or download the meter brochure from www.se.com.

Reference device or energy standard

To help ensure the accuracy of the test, it is recommended that you use a reference device or reference energy standard with a specified accuracy that is 6 to 10 times more accurate than the meter under test. Before you start testing, the reference device or energy standard should be warmed up as recommended by its manufacturer.

NOTE: Reference equipment with a traceable calibration certificate is recommended when performing accuracy testing.

Energy pulsing

Energy pulsing LEDs and digital outputs can be used for energy pulsing.

Your meter is equipped with two types of energy pulsing LEDs: visible light and infrared. These LEDs emit pulses that are then used to determine the accuracy of the meter's energy measurements. The pulses of light indicate accumulated energy; the meter's accumulations are compared with the reference/standard's accumulated energy in order to help determine the meter's accuracy.

The meter's digital output can also be used for energy pulsing. A closing (low impedance) and then opening (high impedance) of the digital output represents a pulse. If the accuracy testing equipment has a voltage requirement, a current-limited wetting supply voltage must be provided.

NOTE: Digital outputs on option modules should not be used for meter accuracy testing.

Verifying accuracy test meter settings

Your meter's power system and other parameters must be configured for accuracy testing.

Meter parameter	Value
Volts mode	4W-Wye (4 wire Wye)
PT/CT correction	Disabled

Verifying accuracy test

The following tests are guidelines for accuracy testing your meter; your meter shop may have specific testing methods.

⚠ DANGER

HAZARD OF ELECTRIC SHOCK, EXPLOSION OR ARC FLASH

- Apply appropriate Personal Protective Equipment (PPE) and follow safe electrical work practices. See NFPA 70E, CSA Z462 or other local standards.
- Turn off all power supplying this device and the equipment in which it is installed before working on or in the equipment.
- Always use a properly rated voltage sensing device to confirm that all power is off.
- Do not exceed the maximum ratings of this device.
- Verify the device's power source meets the specifications for your device's power supply.

Failure to follow these instructions will result in death or serious injury.

1. Connect the test voltage and current source to the reference device or energy standard. Ensure all voltage inputs to the meter under test are connected in parallel and all current inputs are connected in series.

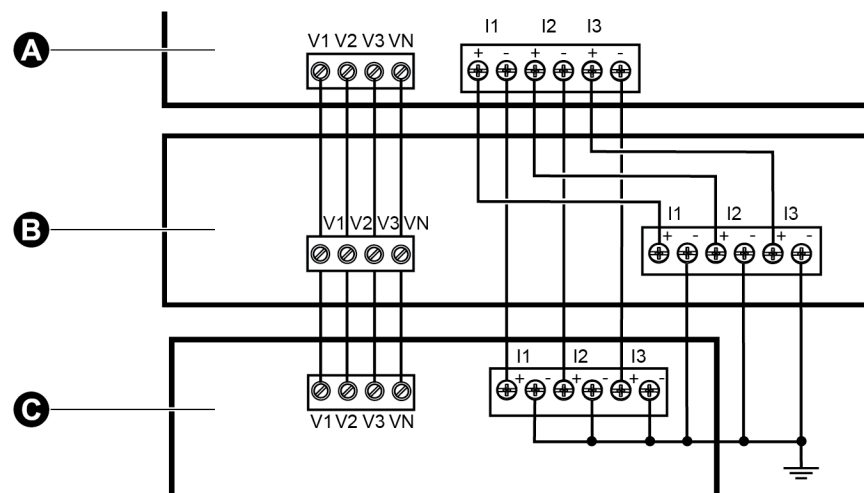

A	Reference device or energy standard
B	Test voltage and current source
C	Meter under test

2. Connect the control equipment used for counting the standard output pulses using one of these methods:

Option	Description
Energy pulsing LED	Align the red light sensor on the standard test bench armature over the energy pulsing LED.
Onboard Digital output	Connect the meter's onboard digital output to the standard test bench pulse counting connections.

NOTE: When selecting which method to use, be aware that energy pulsing LEDs and digital outputs have different pulse rate limits.

3. Before performing the verification test, let the test equipment power up the meter and apply voltage for at least 30 seconds. This helps stabilize the internal circuitry of the meter.
4. Configure your meter power settings (such as voltage, current and frequency) to align with the reference device.
5. Depending on the method selected for counting the energy pulses, configure the meter's energy pulsing LED or one of the digital outputs to perform energy pulsing. Set the meter's energy pulse constant so it is in sync with the reference test equipment.
6. Perform accuracy verification on the test points. Run each test point for at least 30 seconds to allow the test bench equipment to read an adequate number of pulses. Allow 10 seconds of dwell time between test points.

Calculate the number of required pulses

The reference test equipment typically requires you to specify the number of pulses required for a test duration of "t" seconds.

Normally, the number of pulses required is at least 25 pulses, and the test duration is greater than 30 seconds.

Use the following formula to calculate the required number of pulses:

$\text{Number of pulses} = \frac{N_e * V * I * PF * t}{3600 * Kt}$	
N_e	Number of metering elements used
V	Test point voltage in line-to-neutral volts (V) per phase
I	Test point current in amps (A) per phase

t	Test duration in seconds (s) which must be longer than 30 seconds
PF	Power factor
Kt	Pulse constant programmed in the meter under test in Wh/pulse

Round up the result of the calculation to the nearest integer number of pulses.

Calculation for number of required pulses

This example calculates the number of pulses required for an inductive load 3-phase test point with a test duration of 60s; the source is configured to use V = 120V, I = 5A, PF = -0.5; the pulse constant of the meter under test is Kt = 1.8 Wh/pulse.

$$8.3 = \frac{3 * 120 \text{ V} * 5 \text{ A} * .5 * 60 \text{ s}}{3600 * 1.8}$$

Round the number up to the nearest integer: Number of pulses = 9

Percentage error calculation for accuracy verification testing

Accuracy verification testing requires you to calculate the percentage error between the meter being tested and the reference/standard.

Calculate the percentage error for every test point using the following formula:

$$\text{Energy error} = (\text{EM} - \text{ES}) / \text{ES} \times 100\%$$

Where:

- EM = energy measured by the meter under test
- ES = energy measured by the reference device or energy standard.

NOTE: If accuracy verification reveals inaccuracies in your meter, they may be caused by typical sources of test errors. If there are no sources of test errors present, please contact your local Schneider Electric representative.

Typical sources of test errors

If you see excessive errors during accuracy testing, examine your test setup and test procedures to eliminate typical sources of measurement errors.

Typical sources of accuracy verification testing errors include:

- Loose connections of voltage or current circuits, often caused by worn-out contacts or terminals. Inspect terminals of test equipment, cables, test harness and the meter under test.
- Meter ambient temperature is significantly different than 23 °C (73 °F).
- Floating (ungrounded) neutral voltage terminal in any configuration with unbalanced phase voltages.

- Inadequate meter control power, resulting in the meter resetting during the test procedure.
- Ambient light interference or sensitivity issues with the optical sensor.
- Unstable power source causing energy pulsing fluctuations.
- Incorrect test setup: not all phases connected to the reference device or the energy standard. All phases connected to the meter under test should also be connected to the reference meter/standard.
- Moisture (condensing humidity), debris or pollution present in the meter under test.

Accuracy verification test points

The meter should be tested at full and light loads and at lagging (inductive) power factors to help ensure testing over the entire range of the meter.

The test amperage and voltage input rating are labeled on the meter. Refer to the installation guide or data sheet for your meter's nominal current, voltage and frequency specifications.

Watt-hour test point	Sample accuracy verification test point
Full load	100% to 200% of the nominal current, 100% of the nominal voltage and nominal frequency at unity power factor or one (1).
Light load	10% of the nominal current, 100% of the nominal voltage and nominal frequency at unity power factor or one (1).
Inductive load (lagging power factor)	100% of the nominal current, 100% of the nominal voltage and nominal frequency at 0.50 lagging power factor (current lagging voltage by 60° phase angle).

VAR-hour test point	Sample accuracy verification test point
Full load	100% to 200% of the nominal current, 100% of the nominal voltage and nominal frequency at zero power factor (current lagging voltage by 90° phase angle).
Light load	10% of the nominal current, 100% of the nominal voltage and nominal frequency at zero power factor (current lagging voltage by 90° phase angle).
Inductive load (lagging power factor)	100% of the nominal current, 100% of the nominal voltage and nominal frequency at 0.87 lagging power factor (current lagging voltage by 30° phase angle).

Troubleshooting

Review the topics in this section to get more information on how to troubleshoot your meter and where to obtain technical assistance.

Setting up Advanced security troubleshooting

Some users could experience software access issues after enabling Advanced Security mode. Resolve software access issues using these troubleshooting steps:

Meter state	Example behavior	Solution – follow tasks in the order listed
New meter	Login credentials are unknown.	<ul style="list-style-type: none">• Verify that you are using the newest version of ION Setup.• Enter Username: User1 and Password: 0 [zero].

Meter state	Example behavior	Solution – follow tasks in the order listed
Meter recently upgraded to firmware v3.0.0	Using EcoStruxure™ Power Monitoring Expert software and after password is entered, access is not granted.	<ul style="list-style-type: none"> • Verify that you are using the newest version of ION Setup. • Verify you are using meter firmware v3.0.0. • Configure software meter security settings. • Enter meter username: User1 and Password: [password used before upgrade to firmware v3.0.0].
	Using Vista software and after password is entered, access is not granted.	Go to www.se.com and search for support to get assistance with troubleshooting.
	Using EcoStruxure™ Power Operation software.	Go to www.se.com and search for support to get assistance with troubleshooting.
	Incorrect credentials are entered multiple times and a lockout occurs.	Wait until lockout duration is over and account is not locked out. If a user account is locked out, that user can still access the device by entering the correct credentials over a different protocol and communications method.
	Login credentials are unknown.	<ul style="list-style-type: none"> • Verify that you are using the newest version of ION Setup. • Enter meter username: User1 and Password: [password used before upgrade to firmware v3.0.0].

Option module troubleshooting

Events related to option module initialization and operation are stored in your meter's onboard event log. Perform an option bus reset to restart the option bus and re-initialize the option modules attached to your meter. Reviewing the events in the event log within the first minute of option bus reset will provide the most specific details of the detected problem with your option module..

When troubleshooting option modules, attach each option module directly to the meter and verify its operation. If each option module operates when directly connected, use combinations of modules or known good modules to help identify the issue.

Information about your option module's type, serial number, firmware version and present status is available in the Factory and Diagnostics modules.

See *ION Reference*, available from www.se.com, for more information about the Factory and Diagnostics modules.

Technical assistance

Go to www.se.com and search for support to get assistance with troubleshooting.

Have the meter model, serial number and firmware version information ready. See "Device-specific information" on page 254 for details about obtaining this information.

You may be asked by a customer care agent to enable factory access to the device for troubleshooting. Factory access is gained after a unique diagnostic access code is used to login to the device over a secure protocol.

Factory access:

- Is disabled by default.
- Is temporarily enabled for a duration defined in the Factory Access minutes register.
- Requires adequate user privileges to enable.
- Provides read and write permissions.

PM8000 specifications

This section provides additional specifications for your meter and accessories.

NOTE: The information contained in this section is subject to change without notice. You can download updated documentation from www.se.com or contact your local Schneider Electric representative for the latest updates.

Mechanical characteristics

PM8240 series panel mount meter

Mounting position	Vertical
IP degree of protection	Display: IP54 Meter body: IP30 (except connectors)
Display type	1/4 VGA color graphic TFT LCD, 320 x 240 resolution
Display backlight	White LED
Viewable area	70.6 x 52.9 mm (2.78 x 2.08 in)
Keypad	5 button
Maximum number of option modules	4 (based on mechanical stress and required IP rating)

PM8243 DIN meter

Mounting position	Horizontal TS35 DIN rail
IP degree of protection	Meter body: IP30 (except connectors)
Maximum number of option modules	4 (based on mechanical stress and required IP rating)

Mechanical compliance

Vibration	IEC 60068-2-6
Shock	IEC 60068-2-27

Electrical characteristics

True RMS 4–quadrant metering up to the 63rd harmonic on three-phase systems, 256 samples per cycle.

Measurement accuracy

Active energy (Wh)	IEC 62053-22 Class 0.2 S
Reactive energy (VARh)	IEC 62053-24 Class 0.5 S
Power monitoring device (PMD)	IEC 61557-12 PMD/SD/K70/0.2 and PMD/SS/K70/0.2

Active power (P)	IEC 61557-12 Class 0.2
Reactive power (Q_V)	IEC 61557-12 Class 1
Apparent power (S_V)	IEC 61557-12 Class 0.2
Apparent energy (E_{apV})	IEC 61557-12 Class 0.2
Current (I)	IEC 61557-12 Class 0.2
Voltage (U)	IEC 61557-12 Class 0.2
Frequency (f)	IEC 61557-12 Class 0.02

NOTE: Reactive energy and demand values, by default, are based only on the fundamental frequency, and do not include higher harmonics. Active and apparent energy and demand values are measured using the entire signal including harmonics. Contact Technical Support for more information.

Power quality

Power quality instrument (PQI)	IEC 62586-2 IEC 61000-4-30 Class S ($U_{din} = 230\text{ V}$)
Voltage unbalance (U_{nb})	IEC 61557-12 Class 0.2
Voltage harmonics (U_h)	IEC 61557-12 Class 1
Voltage THD (THD_u)	IEC 61557-12 Class 1
Current harmonics (I_h)	IEC 61557-12 Class 1
Current THD (THD_i)	IEC 61557-12 Class 1
Waveform capture	16–256 cycles per sample

Voltage inputs

Specified accuracy range	57 to 400 V L-N / 100 to 690 V L-L (Wye) or 100 to 600 V L-L (Delta)
Specified accuracy frequency	50/60 Hz \pm 15%
Overload	600 V L-N or 1035 V L-L
Impedance	> 5 M Ω
Measurement category	III

Current inputs

Specified accuracy current range	50 mA–10 A
Withstand	20 A continuous, 50 A @ 10 sec/hr, 500 A @ 1 sec/hr
Impedance	0.3 m Ω (typical)
Burden	0.01 VA max at 5 A

Control power

AC control power

Operating range	50/60 Hz \pm 10%: 90–415 V \pm 10% 400 Hz: 90–120 V \pm 10%
Burden (meter only)	max: 7.2 W/18 VA @ 415 V (45–65 Hz) max: 4.5 W/8 VA @ 120 V (400 Hz)
Burden (fully optioned meter)	max: 18 W/36 VA @ 415 V (45–65 Hz) max. 18 W/28 VA @ 120 V (400 Hz)
Ride-through time (no optional accessories)	100 ms (6 cycles at 60 Hz) min., any condition 200 ms (12 cycles at 60 Hz) typ., 120V AC 500 ms (30 cycles at 60 Hz) typ., 415 V AC
DC control power	
Operating range	110–415 V DC \pm 15%
Burden (meter only)	max. 6 W at 300 V DC
Burden (fully optioned meter)	17 W at 300 V DC
Ride-through time	100 ms (6 cycles at 60 Hz) min., any condition

Low-voltage DC control power

DC control power	
Operating range	20–60 V DC \pm 10%
Burden (fully optioned meter)	max: 17 W at 18–60 V DC

Digital output (Form A)

Number	1
Type	Form A solid-state
Maximum load voltage	30 V AC/60 V DC
Maximum load current	75 mA
ON resistance	13–40 Ω at 25 °C (77 °F)
Signal type	Continuous or pulse
Pulse frequency	\leq 25 Hz

Digital inputs

Number	3
Type	Externally excited, polarity independent
Event timestamp accuracy	\pm 1 ms
Maximum voltage	30 V AC/60 V DC
Pulse frequency	\leq 25 Hz
Response time	20 ms
Minimum pulse width	20 ms

Current draw	ON: ≤ 2.5 mA OFF: ≤ 0.5 mA
Voltage ON state	4–30 V AC/4–60 V DC
Voltage OFF state	0–1.4 V AC/0–2.0 V DC
IRIG-B	IRIG-B00x format (unmodulated IRIG-B time code) Coded expressions 0 to 7 are supported but the year data is not used.

Environmental characteristics

Operating temperature	–25 °C to Max temp (–13 °F to Max temp) Note: Maximum operating temperature could change based on the quantity and type of attached option modules. See <i>Maximum operating temperature with option modules</i> below.
Storage temperature	–40 °C to 85 °C (–40 °F to 185 °F)
Humidity rating	5%–95% RH non-condensing Maximum dewpoint: 37 °C (99 °F)
Pollution degree	2
Altitude	< 3000 m (9843 ft) above sea level
Location/mounting	Not suitable for wet locations For indoor use only Must be permanently connected and fixed

Maximum operating temperature with option modules

Maximum operating temperature	PM89M2600 Digital (2 out, 6 in)	PM89M0024 Analog (2 out, 4 in)
70 °C (158 °F)	0–4	0,1
70 °C (158 °F)	0	2
60 °C (140 °F)	1, 2	2–4

LEDs

Energy pulsing LEDs (visible and infrared) located on top of meter

Type	Visible orange, infrared
Wavelength	600–609 nm (orange), 825–925 nm (infrared)
Maximum pulse rate	< 25 Hz (based on line frequency)

EMC (electromagnetic compatibility)

EMC standards	IEC 62052-11, IEC 61326-1
Immunity to electrostatic discharge	IEC 61000-4-2
Immunity to radiated fields	IEC 61000-4-3
Immunity to fast transients	IEC 61000-4-4
Immunity to surges	IEC 61000-4-5
Immunity to conducted disturbances	IEC 61000-4-6
Immunity to power frequency magnetic fields	IEC 61000-4-8
Immunity to conducted disturbances, 2 - 150 kHz	CLC/TR 50579
Immunity to voltage dips and interruptions	IEC 61000-4-11
Immunity to ring waves	IEC 61000-4-12
Conducted and radiated emissions	EN 55011 and EN 55022 Class B, FCC part 15 Class B, ICES-003 Class B
Surge withstand capability (SWC)	IEEE/ANSI C37.90.1

Safety

Safety construction	IEC/EN 61010-1, CAT III, 400 VLN / 690 VLL
	UL 61010-1 and CSA-C22.2 No. 61010-1, CATIII, 347 V LN / 600 VLL
	IEC/EN 62052-11, Protective Class II

Ethernet communications

Number of ports	2 (switched mode)
Maximum cable length	100 m (328 ft), per TIA/EIA 568-5-A
Cable type	CAT5 (or higher)
Connector type	Unshielded RJ45 modular connector (2)
Mode	10Base-T, 100Base-TX, Auto-MDIX

Data rate	up to 100 Mbps
SFTP	Maximum simultaneous transfer connections (sessions): 2 Default timeout period: 90 seconds
IEC 61850 maximum simultaneous client connections	4

RS-485 communications

Number of ports	1
Cable type	Shielded twisted pair
Maximum cable length	1200 m (4000 ft)
Maximum number of devices (unit loads)	Up to 32 devices on the same bus
Parity	None, even, odd
Baud rate	2400–115200, 19200 recommended

Real-time clock

Clock drift (time error)	20 ppm max at 25 °C (77 °F)
Battery backup time	Minimum 7 years under specified storage conditions

MID/MIR

Applicable MID/MIR standards and class index	<ul style="list-style-type: none"> • EN 50470-1:2006 Class C • EN 50470-3:2006 Class C
Type of measuring equipment	Static watt-hour meter
Mechanical environment	M1
Electromagnetic environment	E2
Cover sealing type	Wire and crimp
Applicable measurements	Active import/export energy metering
System types (for MID/MIR-compliant applications)	<ul style="list-style-type: none"> • 3-phase 4-wire Wye grounded • 3-phase 3-wire Delta ungrounded
Current rating	0.05 – 5(10)A
Nominal frequency	50 Hz
Energy pulsing LED	Pulse weight – 5000 imp/kWh

To comply with MID/MIR, the meter must be installed in MID/MIR certified cabinets rated for IP51 or higher.

Display

METSEPM89RD96 display

Display	
Display type	1/4 VGA color graphic TFT LCD 320 x 240 resolution
Display backlight	White LED
Keypad	5 button
Viewable area	70.6 x 52.9 mm (2.78 x 2.08 in)
Communication connection	
Cable type	CAT5 (or higher). Use with unshielded RJ45 modular connector
Cable length	100 m (330 ft) max.
Connection type	Direct, point-to-point
Environment	
IP degree of protection	Front: IP54 Rear: IP30

Option modules

See your option module's installation guide for additional option module specifications.

METSEPM89M0024 Analog (2 out, 4 in)

Maximum number of modules	4
Input resistance	< 300 Ω (current mode) > 500 k Ω (voltage mode)
Input voltage mode	0–30 V DC
Input current mode	4–20 mA , 0–20 mA
Operating temperature	–25 to 70 °C (–13 to 158 °F) Maximum operation temperature is based on the quantity and type of attached option modules.

METSEPM89M2600 Digital (2 out, 6 in)

Maximum number of modules	4
Operating temperature	–25 to 70 °C (–13 to 158 °F) Maximum operation temperature is based on the quantity and type of attached option modules.

METSEPMRS4854W 4-Wire RS-485

Maximum number of modules	1
Operating temperature	–25 to 70 °C (–13 to 158 °F) Maximum operation temperature is based on the quantity and type of attached option modules.

METSEPMFIBER Fiber Ethernet

Maximum number of modules	1
Operating temperature	–25 to 70 °C (–13 to 158 °F) Maximum operation temperature is based on the quantity and type of attached option modules.

Other

Parameter	Description
Meter start time ¹	25 seconds: Measurements
	30 seconds: Communications
	40 seconds: Display initialization
Meter memory	500 MB
Data update rate	Regular data: 1 second
	High-speed: 50/60 Hz half-cycle
Advanced security user accounts	Up to 50 users
¹ Meter start up time is expressed as the typical elapsed time from the application of control power to the result indicated in the description field.	

Open source software components

This Schneider Electric product is provided with certain open source software components (collectively, "OSS") developed by third parties. The OSS is licensed in accordance with the OSS license terms set forth below.

1. The following open source software components are licensed in accordance with the Apache License, Version 2.0.

a. MSTP-LIB

Copyright © 2011-2020 Adi Gostin

Licensed under the Apache License, Version 2.0 (the "License"); you may not use this file except in compliance with the License.

2. The following open source software components are licensed in accordance with the MIT License reprinted below.

a. jQuery

Copyright © 2013 jQuery Foundation and other contributors, <http://jqueryui.com/>

This software consists of voluntary contributions made by many individuals (AUTHORS.txt, <http://jqueryui.com/about>) For exact contribution history, see the revision history and logs, available at <http://jquery-ui.googlecode.com/svn/>.

b. MomentJS

Copyright © JS Foundation and other contributors.

Apache License Version 2.0, January 2004

<http://www.apache.org/licenses/>

TERMS AND CONDITIONS FOR USE, REPRODUCTION, AND DISTRIBUTION

1. Definitions.

"License" shall mean the terms and conditions for use, reproduction, and distribution as defined by Sections 1 through 9 of this document.

"Licensor" shall mean the copyright owner or entity authorized by the copyright owner that is granting the License.

"Legal Entity" shall mean the union of the acting entity and all other entities that control, are controlled by, or are under common control with that entity. For the purposes of this definition, "control" means (i) the power, direct or indirect, to cause the direction or management of such entity, whether by contract or otherwise, or (ii) ownership of fifty percent (50%) or more of the outstanding shares, or (iii) beneficial ownership of such entity.

"You" (or "Your") shall mean an individual or Legal Entity exercising permissions granted by this License.

"Source" form shall mean the preferred form for making modifications, including but not limited to software source code, documentation source, and configuration files.

"Object" form shall mean any form resulting from mechanical transformation or translation of a Source form, including but not limited to compiled object code, generated documentation, and conversions to other media types.

"Work" shall mean the work of authorship, whether in Source or Object form, made available under the License, as indicated by a copyright notice that is included in or attached to the work (an example is provided in the Appendix below).

"Derivative Works" shall mean any work, whether in Source or Object form, that is based on (or derived from) the Work and for which the editorial revisions, annotations, elaborations, or other modifications represent, as a whole, an original work of authorship. For the purposes of this License, Derivative Works shall not include works that remain separable from, or merely link (or bind by name) to the interfaces of, the Work and Derivative Works thereof.

"Contribution" shall mean any work of authorship, including the original version of the Work and any modifications or additions to that Work or Derivative Works thereof, that is intentionally submitted to Licensor for inclusion in the Work by the copyright owner or by an individual or Legal Entity authorized to submit on behalf of the copyright owner. For the purposes of this definition, "submitted" means any form of electronic, verbal, or written communication sent to the Licensor or its representatives, including but not limited to communication on electronic mailing lists, source code control systems, and issue tracking systems that are managed by, or on behalf of, the Licensor for the purpose of discussing and improving the Work, but excluding communication that is conspicuously marked or otherwise designated in writing by the copyright owner as "Not a Contribution."

"Contributor" shall mean Licensor and any individual or Legal Entity on behalf of whom a Contribution has been received by Licensor and subsequently incorporated within the Work.

2. Grant of Copyright License. Subject to the terms and conditions of this License, each Contributor hereby grants to You a perpetual, worldwide, non-exclusive, no-charge, royalty-free, irrevocable copyright license to reproduce, prepare Derivative Works of, publicly display, publicly perform, sublicense, and distribute the Work and such Derivative Works in Source or Object form.

3. Grant of Patent License. Subject to the terms and conditions of this License, each Contributor hereby grants to You a perpetual, worldwide, non-exclusive, no-charge, royalty-free, irrevocable (except as stated in this section) patent license to make, have made, use, offer to sell, sell, import, and otherwise transfer the Work, where such license applies only to those patent claims licensable by such Contributor that are necessarily infringed by their Contribution(s) alone or by combination of their Contribution(s) with the Work to which such Contribution(s) was submitted. If You institute patent litigation against any entity (including a cross-claim or counterclaim in a lawsuit) alleging that the Work or a Contribution incorporated within the Work constitutes direct or contributory patent infringement, then any patent licenses granted to You under this License for that Work shall terminate as of the date such litigation is filed.

4. Redistribution. You may reproduce and distribute copies of the Work or Derivative Works thereof in any medium, with or without modifications, and in Source or Object form, provided that You meet the following conditions:

1. You must give any other recipients of the Work or Derivative Works a copy of this License; and

2. You must cause any modified files to carry prominent notices stating that You changed the files; and
 3. You must retain, in the Source form of any Derivative Works that You distribute, all copyright, patent, trademark, and attribution notices from the Source form of the Work, excluding those notices that do not pertain to any part of the Derivative Works; and
 4. If the Work includes a "NOTICE" text file as part of its distribution, then any Derivative Works that You distribute must include a readable copy of the attribution notices contained within such NOTICE file, excluding those notices that do not pertain to any part of the Derivative Works, in at least one of the following places: within a NOTICE text file distributed as part of the Derivative Works; within the Source form or documentation, if provided along with the Derivative Works; or, within a display generated by the Derivative Works, if and wherever such third-party notices normally appear. The contents of the NOTICE file are for informational purposes only and do not modify the License. You may add Your own attribution notices within Derivative Works that You distribute, alongside or as an addendum to the NOTICE text from the Work, provided that such additional attribution notices cannot be construed as modifying the License. You may add Your own copyright statement to Your modifications and may provide additional or different license terms and conditions for use, reproduction, or distribution of Your modifications, or for any such Derivative Works as a whole, provided Your use, reproduction, and distribution of the Work otherwise complies with the conditions stated in this License.
5. Submission of Contributions. Unless You explicitly state otherwise, any Contribution intentionally submitted for inclusion in the Work by You to the Licensor shall be under the terms and conditions of this License, without any additional terms or conditions. Notwithstanding the above, nothing herein shall supersede or modify the terms of any separate license agreement you may have executed with Licensor regarding such Contributions.
6. Trademarks. This License does not grant permission to use the trade names, trademarks, service marks, or product names of the Licensor, except as required for reasonable and customary use in describing the origin of the Work and reproducing the content of the NOTICE file.
7. Disclaimer of Warranty. Unless required by applicable law or agreed to in writing, Licensor provides the Work (and each Contributor provides its Contributions) on an "AS IS" BASIS, WITHOUT WARRANTIES OR CONDITIONS OF ANY KIND, either express or implied, including, without limitation, any warranties or conditions of TITLE, NON-INFRINGEMENT, MERCHANTABILITY, or FITNESS FOR A PARTICULAR PURPOSE. You are solely responsible for determining the appropriateness of using or redistributing the Work and assume any risks associated with Your exercise of permissions under this License.
8. Limitation of Liability. In no event and under no legal theory, whether in tort (including negligence), contract, or otherwise, unless required by applicable law (such as deliberate and grossly negligent acts) or agreed to in writing, shall any Contributor be liable to You for damages, including any direct, indirect, special, incidental, or consequential damages of any character arising as a result of this License or out of the use or inability to use the Work (including but not limited to damages for loss of goodwill, work stoppage, computer failure or malfunction, or any and all other commercial damages or losses), even if such Contributor has been advised of the possibility of such damages.

9. Accepting Warranty or Additional Liability. While redistributing the Work or Derivative Works thereof, You may choose to offer, and charge a fee for, acceptance of support, warranty, indemnity, or other liability obligations and/or rights consistent with this License. However, in accepting such obligations, You may act only on Your own behalf and on Your sole responsibility, not on behalf of any other Contributor, and only if You agree to indemnify, defend, and hold each Contributor harmless for any liability incurred by, or claims asserted against, such Contributor by reason of your accepting any such warranty or additional liability.

END OF TERMS AND CONDITIONS

The MIT License

Permission is hereby granted, free of charge, to any person obtaining a copy of this software and associated documentation files (the "Software"), to deal in the Software without restriction, including without limitation the rights to use, copy, modify, merge, publish, distribute, sublicense, and/or sell copies of the Software, and to permit persons to whom the Software is furnished to do so, subject to the following conditions:

The above copyright notice and this permission notice shall be included in all copies or substantial portions of the Software.

THE SOFTWARE IS PROVIDED "AS IS", WITHOUT WARRANTY OF ANY KIND, EXPRESS OR IMPLIED, INCLUDING BUT NOT LIMITED TO THE WARRANTIES OF MERCHANTABILITY, FITNESS FOR A PARTICULAR PURPOSE AND NONINFRINGEMENT. IN NO EVENT SHALL THE AUTHORS OR COPYRIGHT HOLDERS BE LIABLE FOR ANY CLAIM, DAMAGES OR OTHER LIABILITY, WHETHER IN AN ACTION OF CONTRACT, TORT OR OTHERWISE, ARISING FROM, OUT OF OR IN CONNECTION WITH THE SOFTWARE OR THE USE OR OTHER DEALINGS IN THE SOFTWARE.

Schneider Electric
35 rue Joseph Monier
92500 Rueil Malmaison – France
www.se.com

As standards, specifications, and designs change from time to time, please ask for confirmation of the information given in this publication.

©2020 Schneider Electric. All Rights Reserved.

7EN02-0336-08 12/2021