

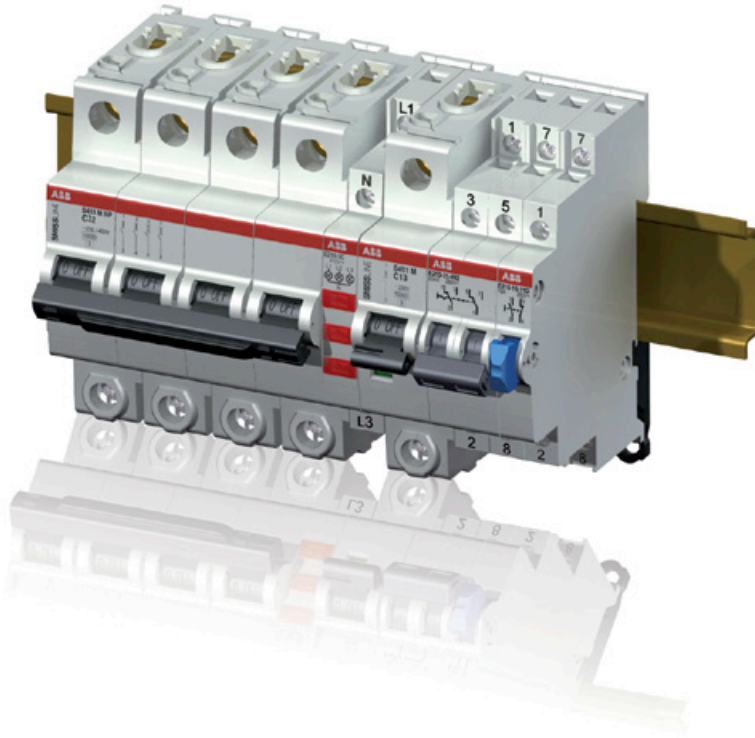

Product range E 210
On-off switches, pushbuttons,
indicator lights
System pro *M* compact[®]

Half-size Strong effect



The new 9 and 18 mm wide ABB modular command or control devices for DIN 35 mm mounting rail attachment in the system pro M compact® design.



ABB modular command or control devices can be used in the SMISLINE socket system (without contact to the bus bar).

Contents

Applications	Page 0/4
Sample applications	Page 1/1
Characteristics Product range E 210	Page 2/1
Device overview	Page 3/1
Ordering data	Page 4/1
Technical data	Page 5/1
Dimensions	Page 6/1
Approval and standards	Page 7/1

Applications

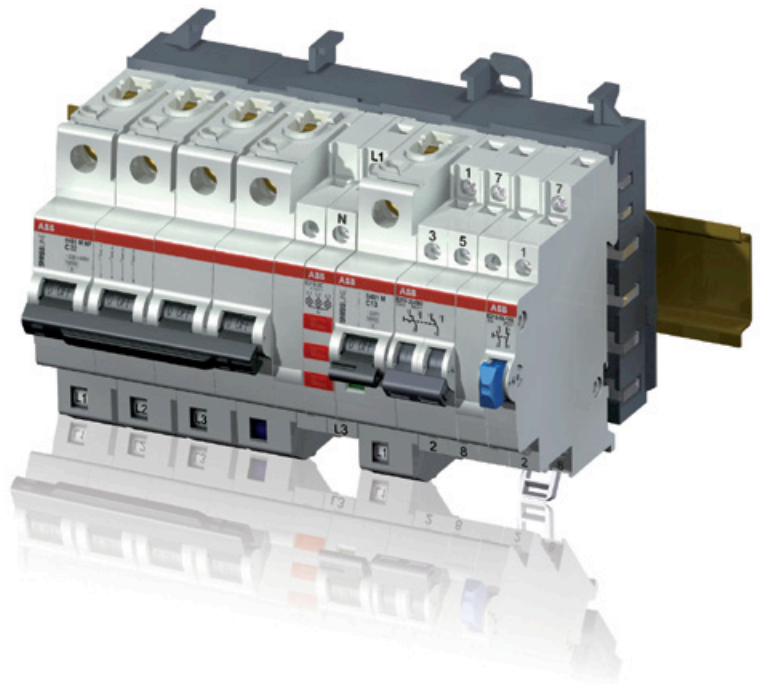
On-off switches, pushbuttons, indicator lights

Using modular DIN-rail mounted devices (MDRC) such as On-Off switches, pushbuttons and indicator lights makes it possible to switch and control electric loads from a central location. Thanks to signalling of the switch position, operating states can be recognized easily and users have an overview of the situation. Space is saved in the distribution board thanks to the new narrow width of only 9 mm (0.5 modular width). The On-Off switches are easy to operate and the switched position is always clearly recognisable. Depending on requirements, the switch position can also be indicated by a built-in yellow LED. The pushbuttons are excellently suitable for forwarding pulse control commands, e.g. in lighting controls. The operating state of the luminous pushbutton variants can be signalled. The indicator lights are optimally used to signal or report back an operating state.



Private electrical installations

All E210 devices can be used in subdistribution boards of multiple or single-family dwellings and other private buildings. Optimum operability and/or signalling of operating states is made easily possible.

Examples:

- Phase monitoring
- Signalling the operating state of a pond pump
- Switching machines in a DIY workshop
- Switching additional garden lighting On/Off
- Visualising the garden/garage door position

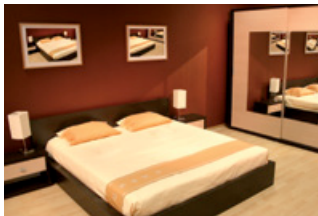

Commercial installations

In guesthouses, hotels, storage halls, small workshops, construction sites and other commercial operations, the E210 devices enable easy switching, control and signalling, thus providing a clear general picture of current operating states.

Examples:

- Outdoor lighting systems
- Additional electric heaters
- Visual status indication of machines and devices (e.g. a fan)
- Outdoor sockets
- Hotel reception (switching and/or monitoring functions)



Industrial installations

The E210 product range is also used in all industrial establishments.

Examples:

- Phase monitoring
- Manual flap controls (ventilation systems)
- Switching pumps On/Off
- Manual -0 - Automatic changeover
- Manual changeover of two-speed machines

Integration of modular installation devices (on-off switches, pushbuttons and indicator lights) in the subdistribution board affords the additional advantage of intelligible signalling of electric loads' operating states. Easy operation or interpretation of devices is ensured by the clearly recognizable switching position (toggle lever) and/or a status display by means of an LED light. Depending on the system requirements, further signalling or control functionality for reliable operation can be used in the subdistribution board in the form of pushbuttons or indicator lights.

Electric heating devices

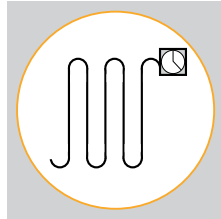

On-off switches, pushbuttons and pushbuttons with LED

Manual direct or pulse-controlled On/Off switching of additional heating elements, e.g. in DIY workshops or other purpose-built installations.

Lighting systems

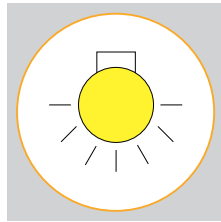

On-off switches

As master switches for multiple-phase lighting sections, e.g. in halls, large basement rooms or provisional constructions.

Pushbuttons and pushbuttons with LED (puls contact operation)

Issuing of commands to latching relay or miniature contactors with visual feedback.

Air conditioners and fans

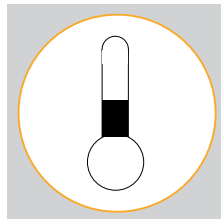

On-off switches or pushbuttons

Connecting air conditioners or ventilation fans as required.

Change over switches or group switches I-0-II

Switching over fans with two operating levels

Group switches I-0-II

Manual - 0 - Automatic changeover (from normal to emergency mains)

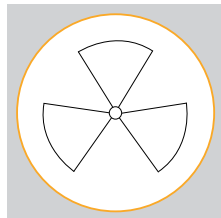

Signalling

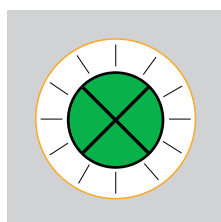

On-off switches or pushbuttons with LED

Clear signalling and indication of the operating states of electric loads.

Indicator lights

Phase monitoring display

Signalling On, Off or Danger (colours, e.g. green, red, yellow)

Sample applications

On-off switches and control switches

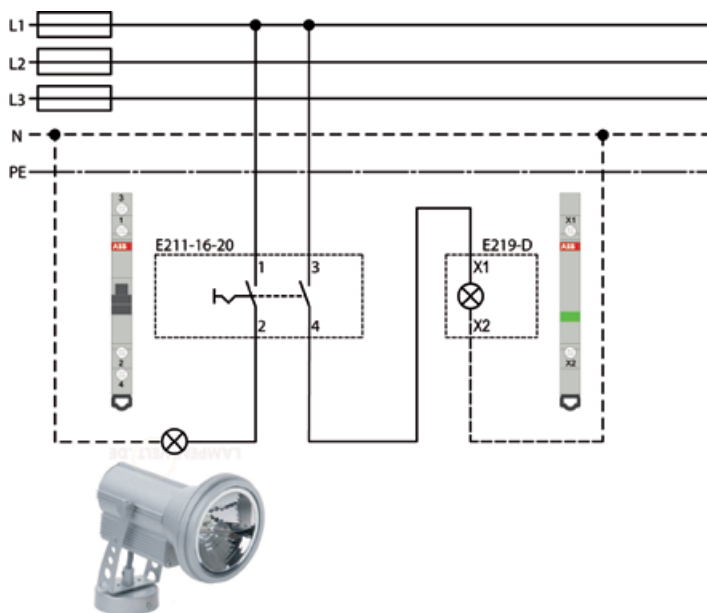

Additional garden lighting

On-off switches E211-16-20 (2NO contacts) and indicator lights E219-D

- On-off control for additional garden light
- The green indicator light in the central distribution board shows whether the garden light is ON or OFF

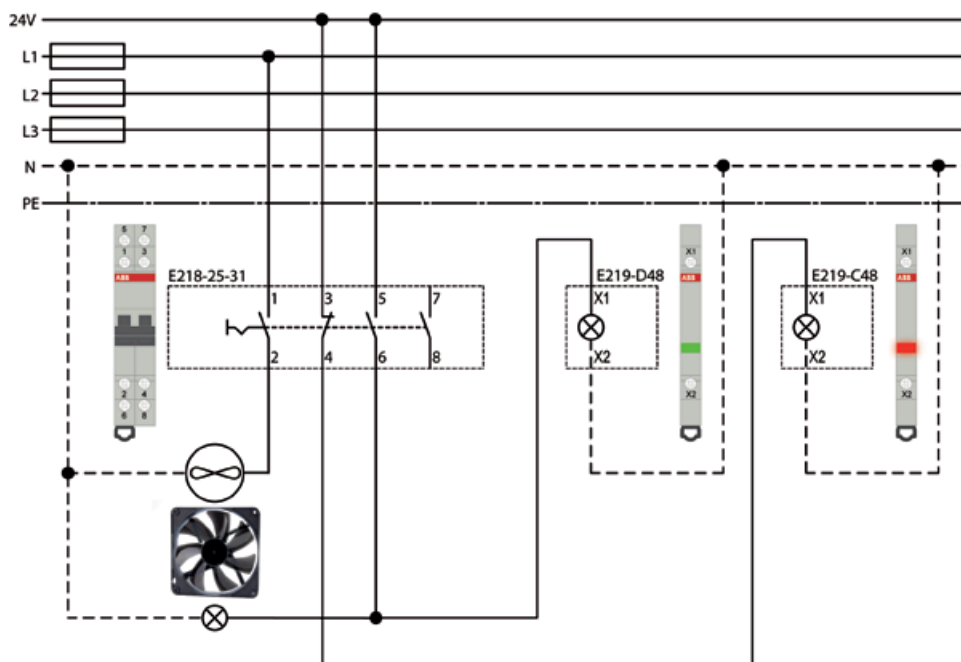

Room ventilator with status display

Control switches E218-25-31 (3NO + 1NC contacts) and E219-D48; E219-C48

- On-off function control of a ventilator
- Integrated signal lamp 24 V for status detection is directly embedded at the ventilator
- The green and red indicator lights 12-48 V show the current operating position in the central distribution board

Change over switches and group switches

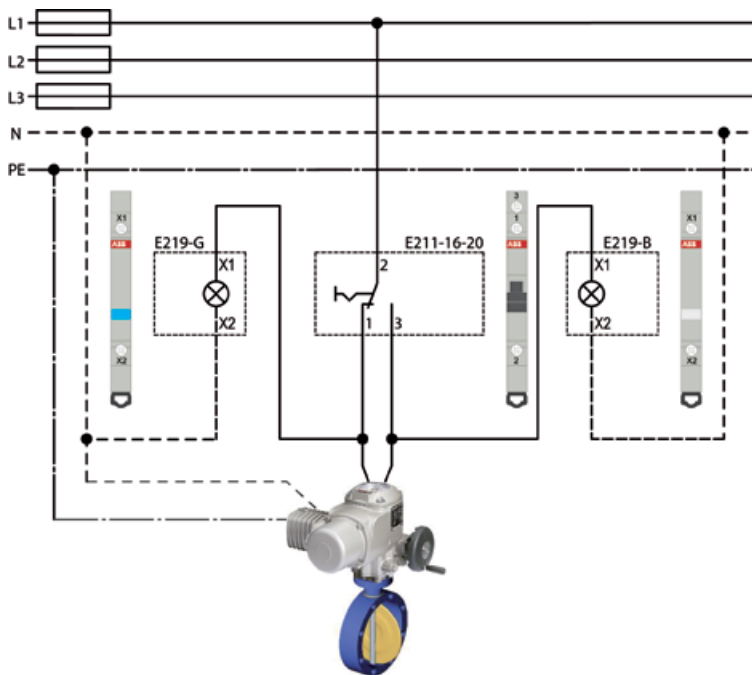

Flap gate control

Change over switches E213-16-001 with position I-II (1CO contact) and E219-G; E219-B

- Control of a manual flap gate position with central visualization
- The blue indicator light shows that the flap gate is open
- The white indicator light shines in closed state

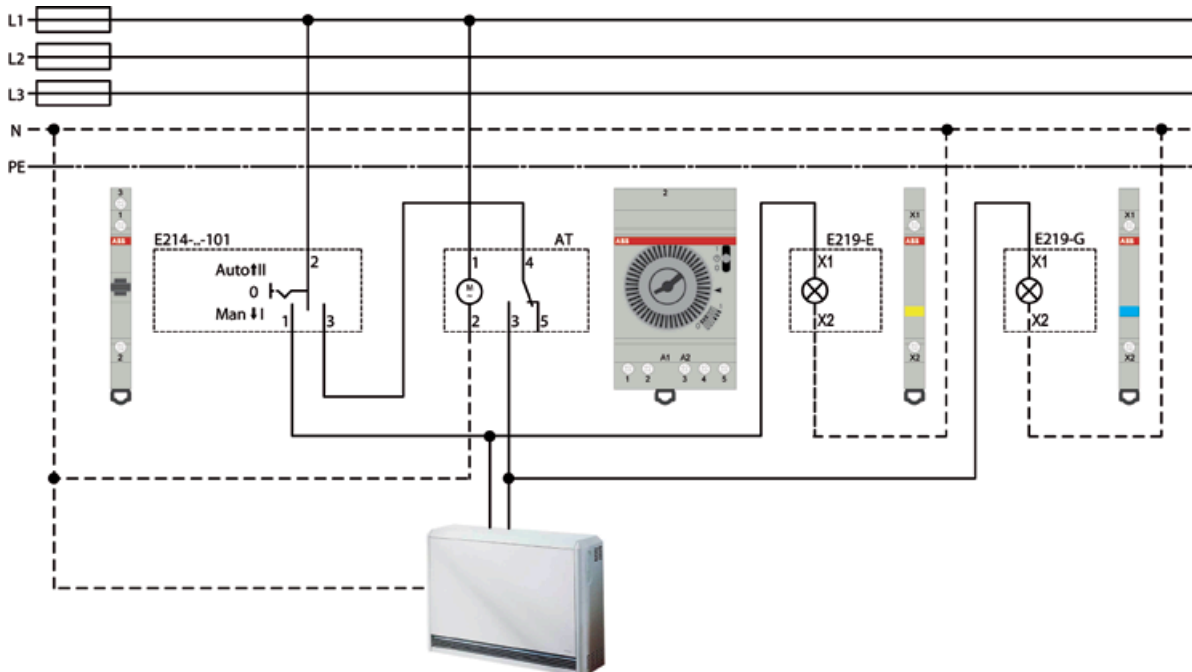

Electrical room heater

Group switches E214-16-101 with position I-0-II (1CO contact) and E219-E; E219-G

- Changeover switching of manual control to time switch mode, e. g. for an additional heater
- The yellow indicator light shows that the control mode occurs manually
- The heater is set on automatic control when the blue E219-G shines

Sample applications

Push buttons

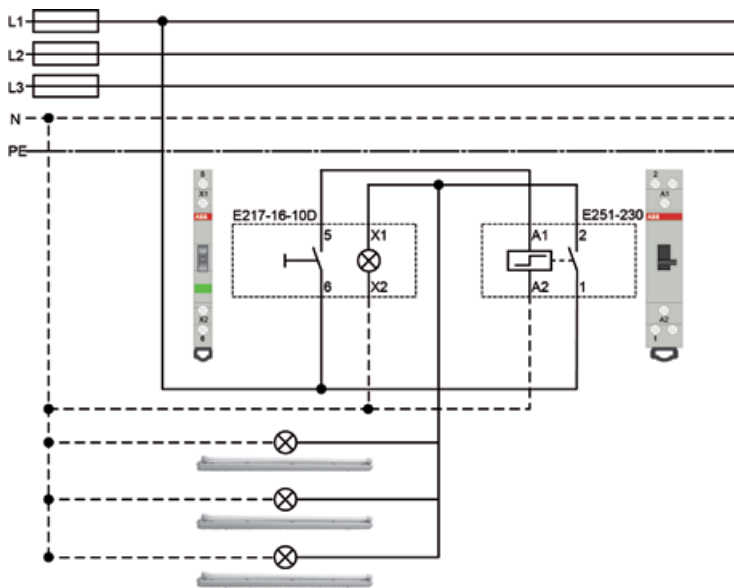

Room lighting (fluorescent-tubes)

Pushbuttons mit 1NO contact (impulse) with green LED

- Lighting system with latching relay (impulse switching relays)
- The green LED which is integrated in the pushbutton shines when the lighting group has the status ON

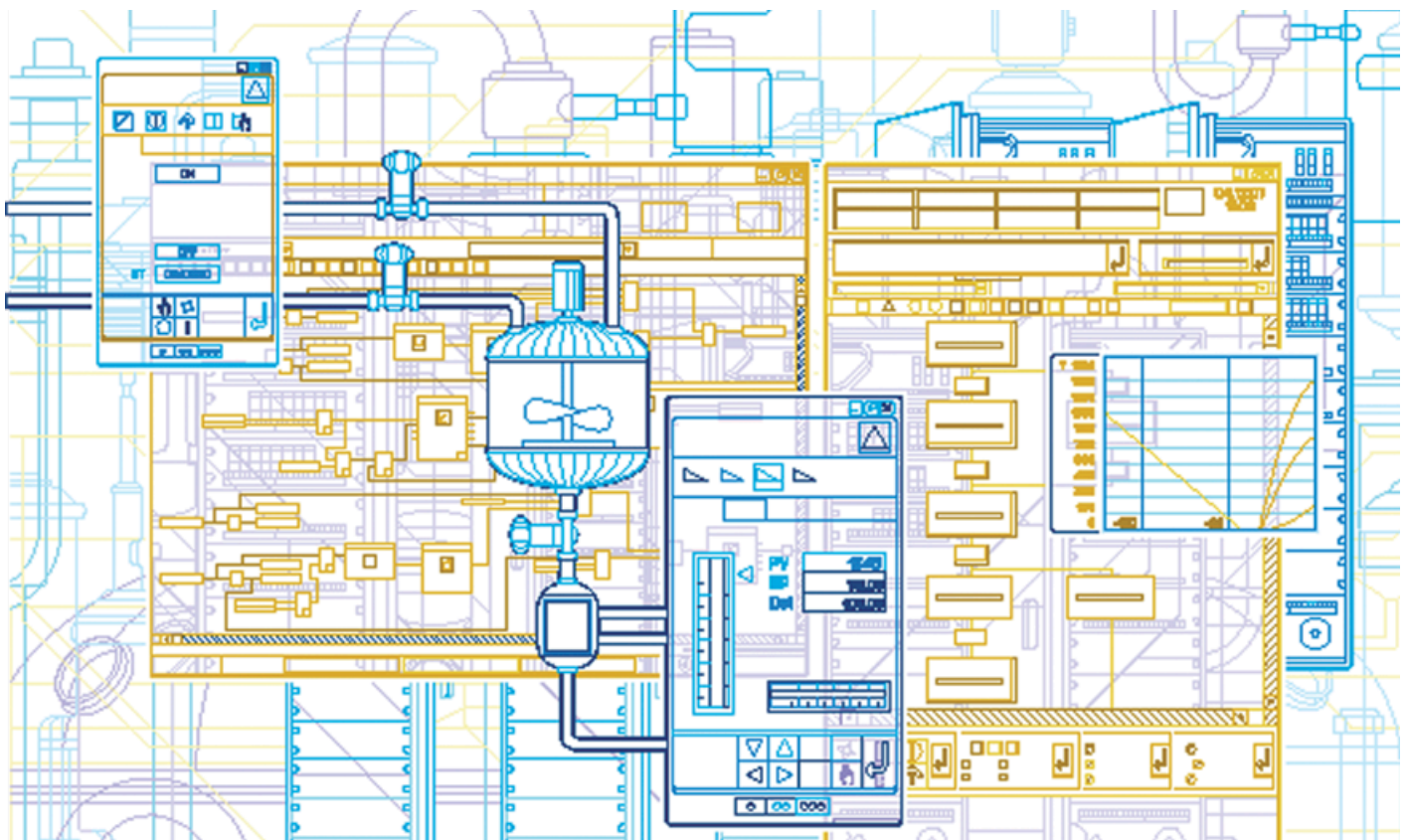

Multiple indicator lights

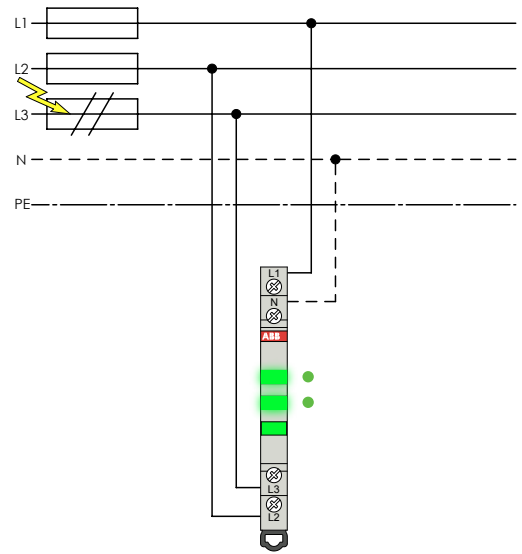
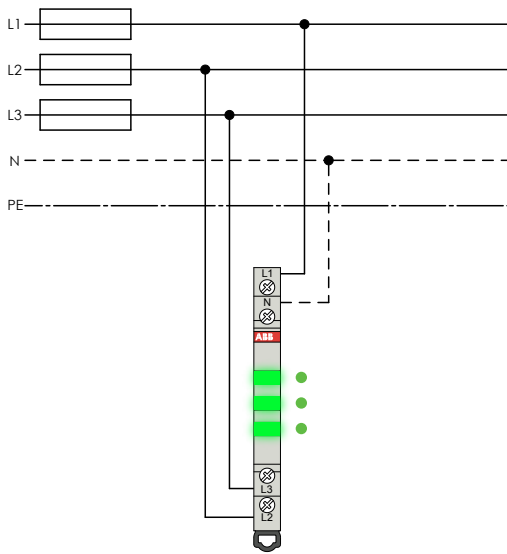

Network and phase control

Multiple indicator lights E219-3D (3x green LEDs)

- All LEDs shine → Net is working
- If one phase breaks down, the green LED turns off
→ Attention! Phase break down in the network

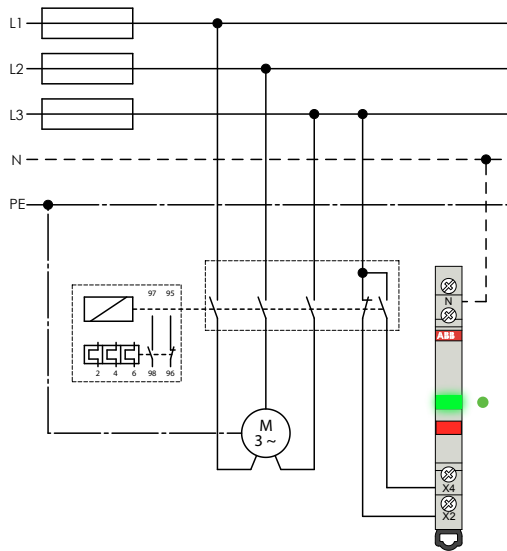

Signaling motor OFF

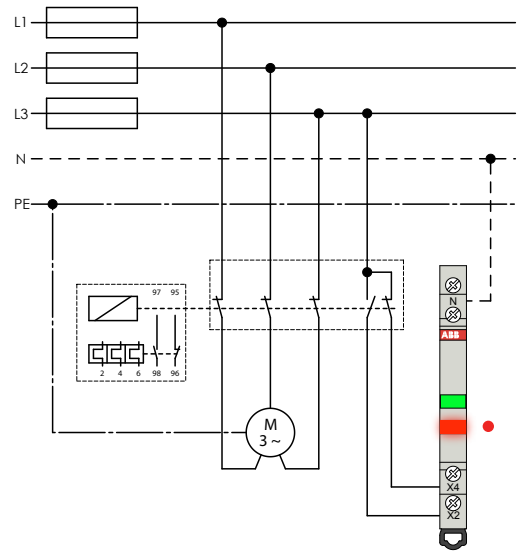

Signaling motor ON

Motor status display

Multiple indicator lights E219-2CD (1x green, 1x red LED)

- ABB three-phase contactor (remote controlled with 2 auxiliary contacts (1NO + 1NC))
- The current operating mode of the motor drive is visualized over auxiliary contacts.

Sample applications

Multiple indicator lights

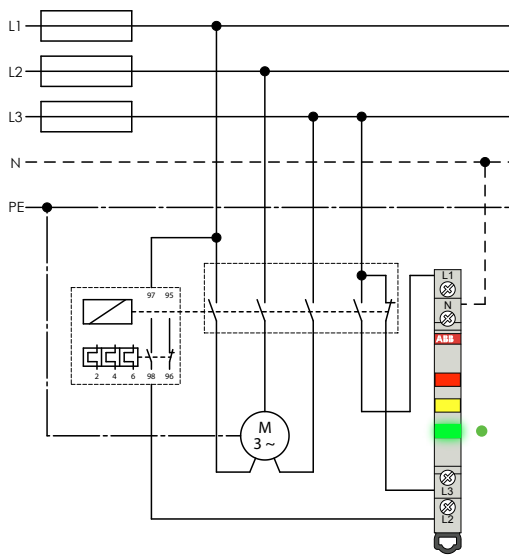

Signaling motor OFF

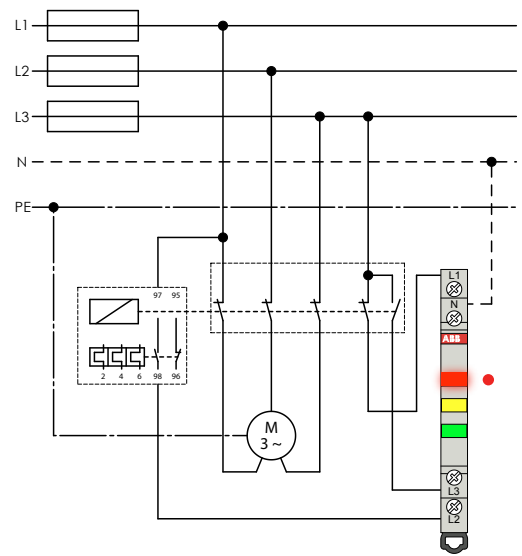

Signaling motor ON

Motor status display

Multiple indicator lights E219-3CDE (1x green, 1x yellow, 1x red LED)

- ABB polyphase contactor gate (remote control) with 2 auxiliary contacts (1NO + 1NC)
- The current operating mode of the motor drive is visualized over contactor auxiliary contacts
- The error indication occurs over the signalling contact of the motor protection relay

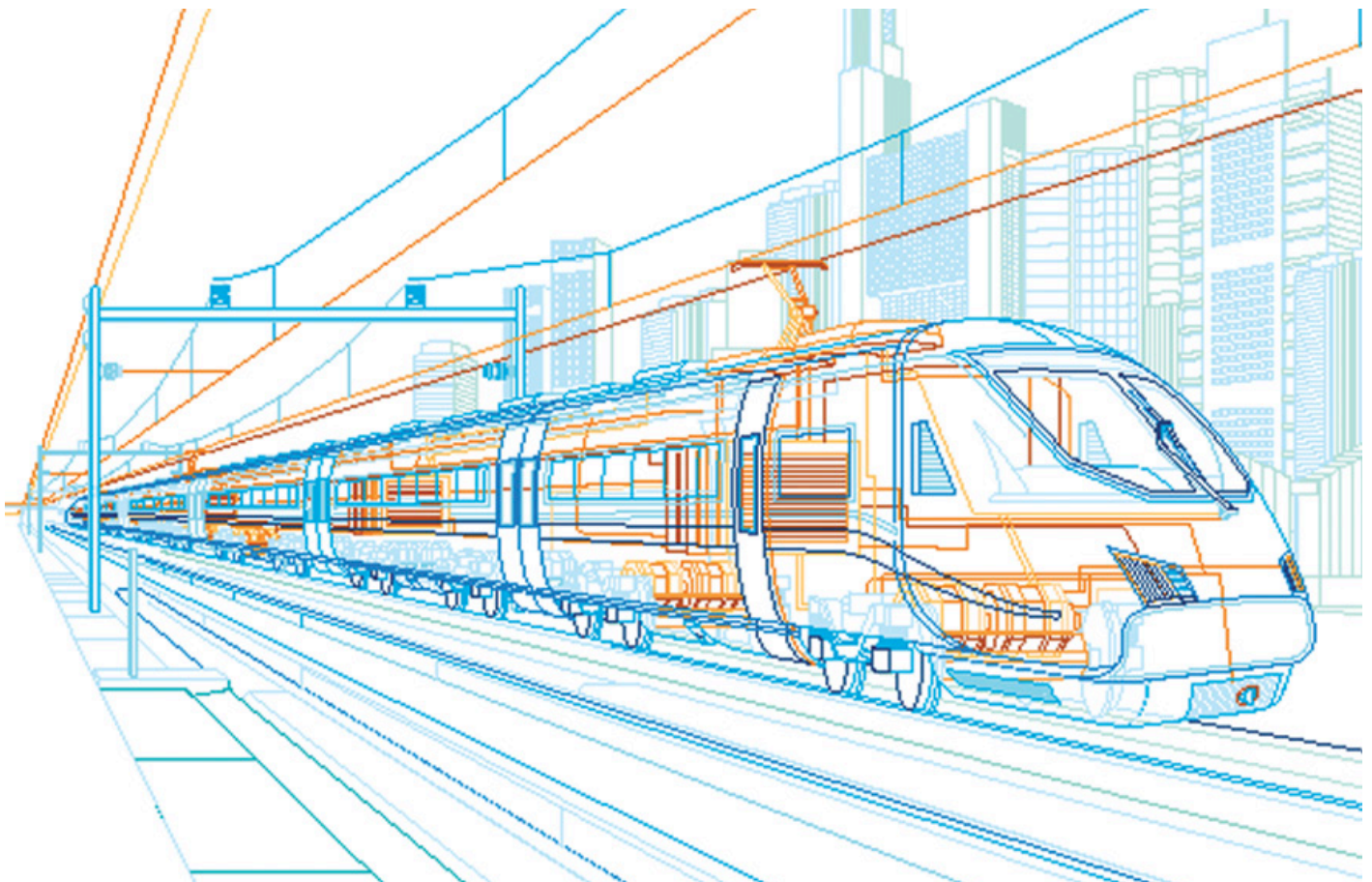

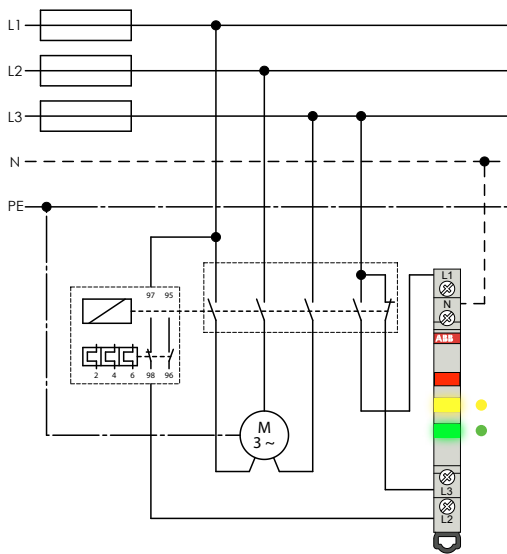

**Signaling motor interference
on basis of thermal overload**

Motor status display (off and interruption)

Multiple indicator lights E219-3CDE (1x green, 1x yellow, 1x red LED)

- A thermal activation is signaled by the use of motor protection relay contacts
- Motor off = green LED on; closed motor protection relay contact = yellow LED shows interference

Characteristics

On-off switches, change over switches and group switches

The On-Off switches, pushbuttons and indicator light units open up new space-saving and modern installation possibilities.

The units are for switching, controlling or signalling part of electrical systems or specific items of equipment. The new Series E210 units are available in widths of 9 mm (0.5 modular width) or 18 mm (1.0 modular width).



On-Off switches, 16 A, 25 A and 32 A

These switches are installed directly in the subdistribution board and are used as manual master switches for direct On/Off switching of courtyard or basement lighting systems, ventilation and air conditioning systems, fans or special lighting systems with gas discharge lamps.

Module width depends on the contact configuration.

1 + 2 switching contacts = 9 mm (0,5 modular width)

3 + 4 switching contacts = 18 mm (1 modular width)



On-Off switches, 16 A and 25 A with switch position indication

The unit's switched position is signalled clearly by the integrated LED. Thanks to the easily visible lit amber LED, which operating states the various items of equipment are in is clearly recognisable on the distribution board.

Module width depends on the contact configuration.

1 switching contact + LED = 9 mm (0.5 modular width)

2 + 3 switching contacts + LED = 18 mm (1 modular width)



Change over switches, 16 A and 25 A

With its two switched positions, the change over switch is used in industry and building management systems. Clear recognisability of the switch's settings I and II enables reliable and easy use. Applications consist of switching over from normal to emergency lighting, changing over an outdoor lighting system with light sensor to normal operation and many other possibilities.

Module width depends on the contact configuration.

1 changeover contact = 9 mm (0.5 modular width)

2 changeover contacts = 18 mm (1 modular width)



Group switches I-0-II 16 A and 25 A

The group switches offer universal application possibilities in industry, building management systems and house installations. They are used in lighting and machine control systems, for example. Using these units, a Manual - 0 - Automatic control can be realised with ease.

Module width depends on the contact configuration.

1 changeover contact = 9 mm (0.5 modular width)

2 changeover contacts = 18 mm (1 modular width)

Control switches, pushbuttons and indicator lights



Control switches, 16 A and 25 A

The control switches are used in electric control cabinets or house distribution boards. They offer universal possibilities of use with their diverse variants. They perform the task of forwarding control commands.

Module width depends on the contact configuration.

1 + 2 switching contacts = 9 mm (0.5 modular width)

3 + 4 switching contacts = 18 mm (1 modular width)



Pushbutton, 16 A - 6 different pushbutton colours (Pulse contact operation)

Normal pushbuttons are always equipped with a normally-open and a normally-closed contact. The pushbuttons' various colours (six colours) are based on DIN60204-1 (colour marking of operator control parts and their significance). These pushbutton devices are suitable for forwarding pulse control command in almost every electrical system. They can also be used to operate lighting groups by means of a pulse command, e.g. to a latching relay or directly on the spot from the subdistribution board or the distribution cabinet. Module width is always 9 mm (0.5 modular width)



Pushbutton, 16 A with LED - 5 different colours (Pulse contact operation)

The pushbuttons with an LED are equipped with only one contact (normally open or closed). Here, you have to choose between a normally-open or normally-closed version. The LED lights, various colours, are based on DIN60204-1 (colour marking of operator control parts and their significance).

The pushbuttons with LED are excellently suitable for signalling or reporting back the operating state of loads controlled.

e.g. pump On = green LED lit; pump Off = LED not lit

The pushbuttons with LED are available in 12-48 V versions for DC or AC voltage, 115-250 VAC voltage and 60-220 VDC voltage.



Indicator lights with 1 LED - 5 different LED colours

The indicator lights warrant a clear overview of the operating states of electrical equipment from one central location. The long useful life of LED technology promises maintenance-free operation for up to 100,000 hours.

For comparison: the incandescent bulbs previously used had a maximum operating operating time of 10,000 hours.

The indicator lights are available in 12-48 V versions for DC or AC voltage, 115-250 VAC voltage and in a version for 60-220 VDC voltage.

All code colours white, red, green, yellow and blue are available for the well-known functions:

Neutral	= white	□
Emergency	= red	■
Normal operation	= green	■
Abnormal operation	= yellow	■
Compelling action	= blue	■

Characteristics

multiple indicator lights



Multiple indicator lights with 2 or 3 LEDs

These indicator lights are perfectly suited to the visualisation of on and off states. These devices can be used in private electrical equipment, commercial buildings or industrial switchgears. This application can be implemented in the smallest space in the apartment or control distributor.

The indicator lights are available with LEDs in the colours green and red, 3x red or in the traffic light colours red, yellow and green. Two different voltage ranges are available:

2 LEDs versions: 115-250 VAC or 12-48 VAC/DC

3 LEDs versions: 415/250 VAC

Module width is always 9 mm (0.5 modular width)



All code colours white, red, green, yellow and blue are available for the well-known functions:

Neutral	= white	□
Emergency	= red	■
Normal operation	= green	■
Abnormal operation	= yellow	■
Compelling action	= blue	■

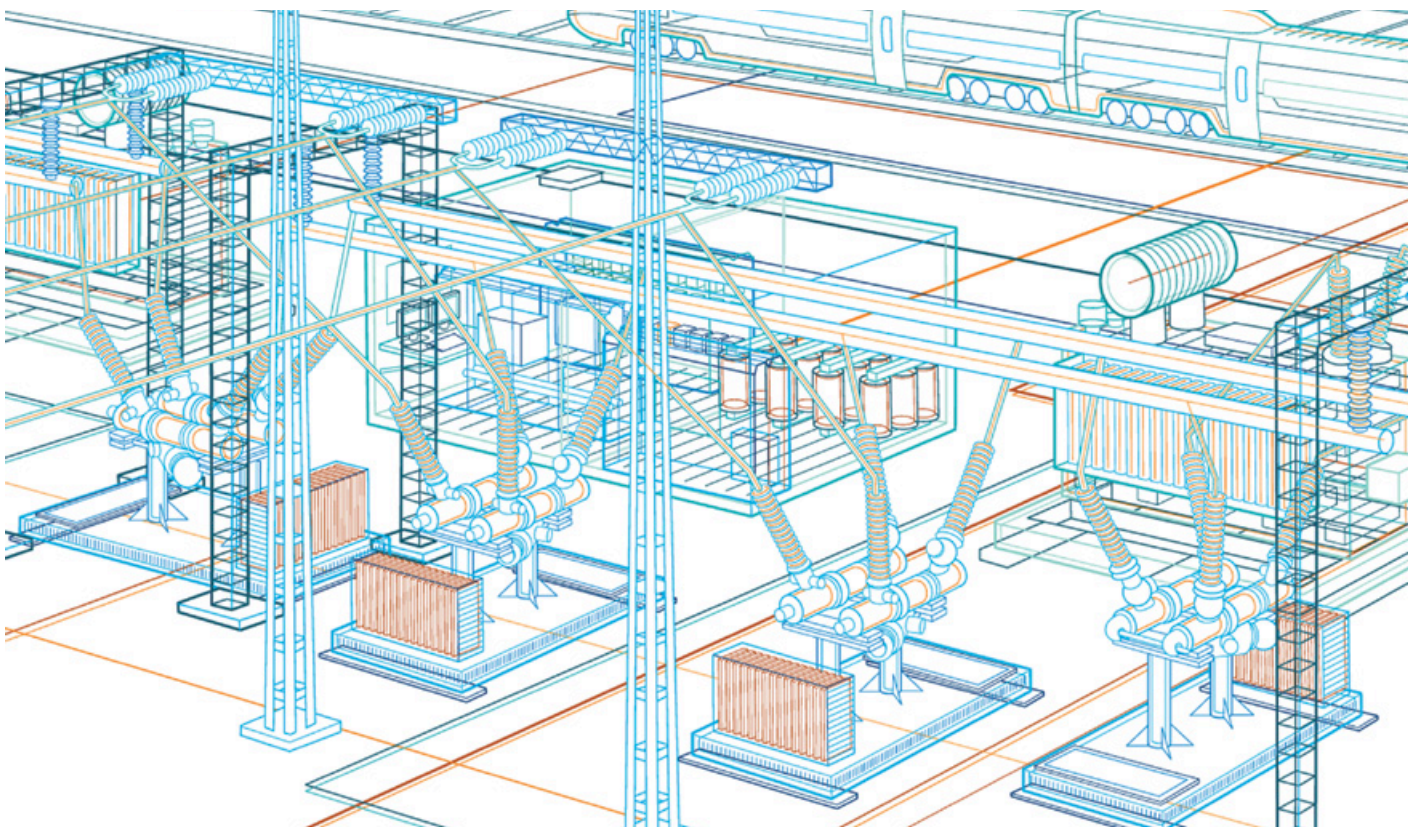

Set new standards in your electrical distribution board

The reduced device width saves space while providing the same functionality and improved performance

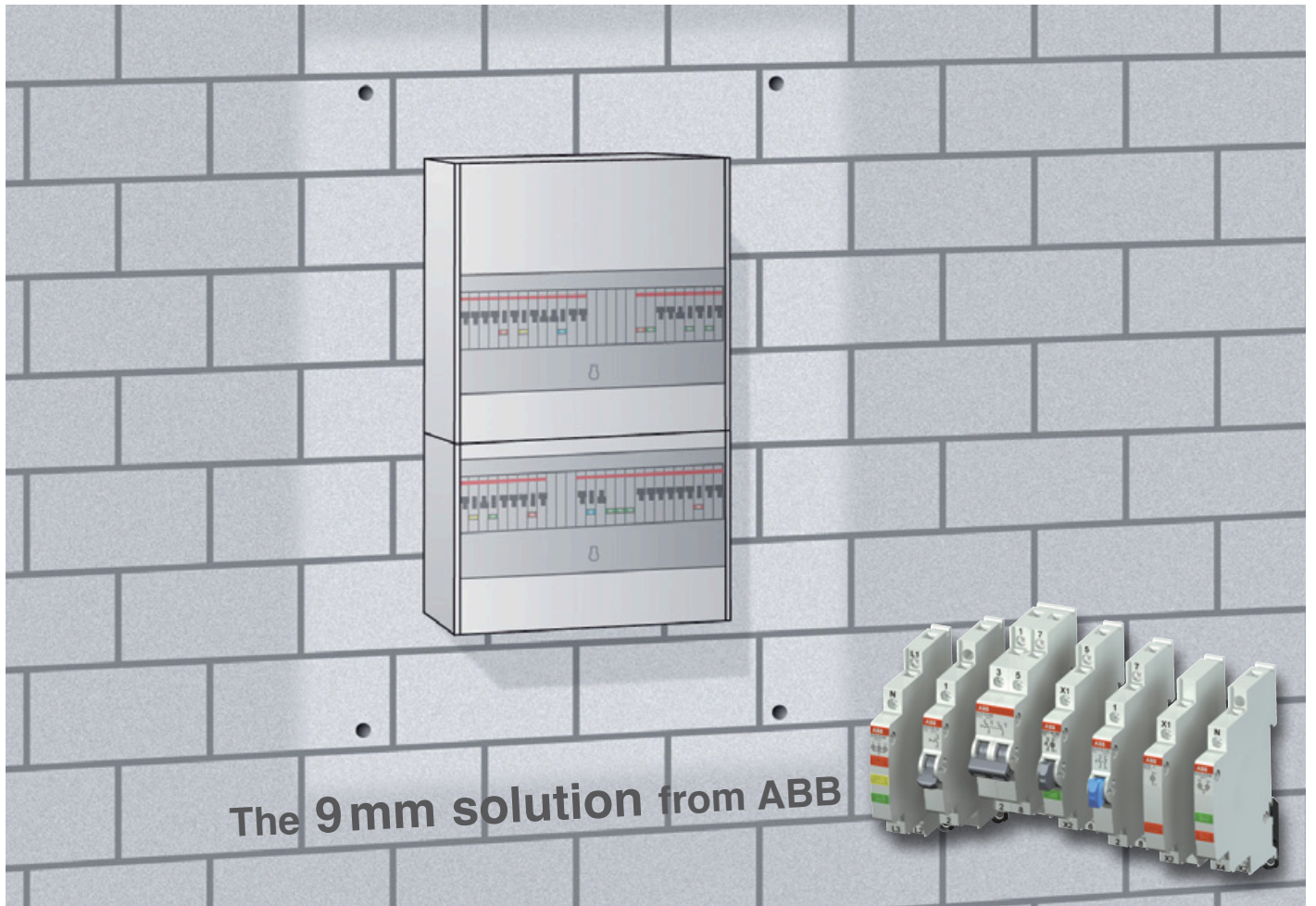

More space plus improved performance

Characteristics

Special features

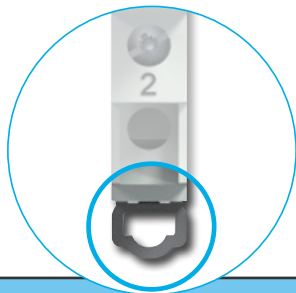

- **Fast mounting**
Easily accessible with latching function

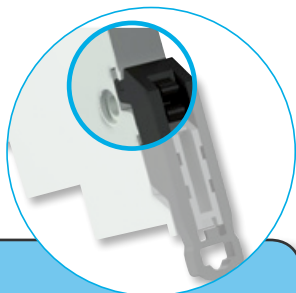

- **Switch position**
clearly recognisable

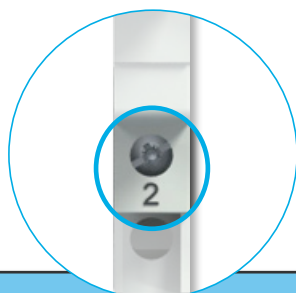

- **Cross-head recessed screws**
Pozidrive 1 (captive)

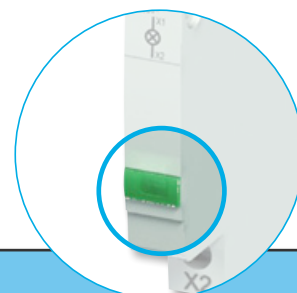

- **Indicator lights**
5 different colours (red, green, yellow, blue, white)

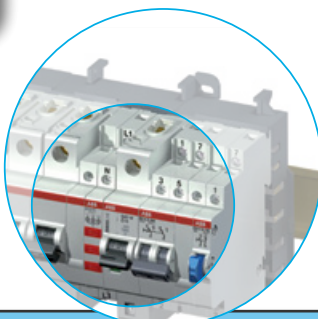

- **Can be used in the SMISLINE socket system**



- **Reliable connection terminals**
with integrated shutter



- **Pushbutton**
6 different colours (grey, red, green, yellow, black, blue)

Impressive solutions at a glance

On-off switches, pushbuttons, indicator lights

- Touch protection to DIN EN 50274 (DIN VDE0660 Part 514)
- Reliable and convenient operation
- Colour-fast LEDs: 5 colours for luminous pushbuttons and indicator lights
- LED voltage ranges: 12-48 VAC/DC; 115-250 VAC; 60-220 VDC
- Multiple indicator lights with 2 or 3 LEDs
- Maintenance-free LED light source (up to 100,000 h)
- Consistent innovative design
- Dissipated power optimised
- Compliance with international standards

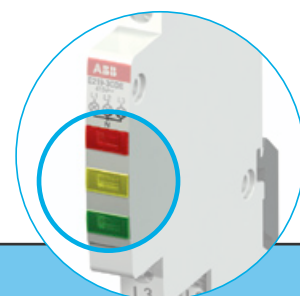

- **Multiple indicator lights with 2 or 3 LEDs**



- **Type designation and schematic with lasting laser marking**



- **Visual switch position indication by On/Off switches (with LED light)**

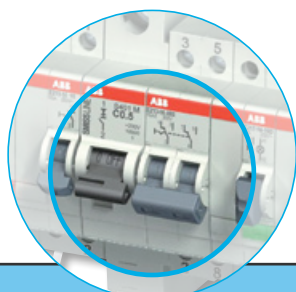

- **Uniform design ABB pro M compact device family**



- **On/Off switch, lockable in the On or Off setting**

Device overview

On-off switches, change over switches, group switches, control switches

On-off switches

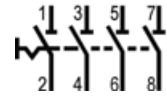
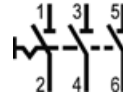
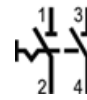
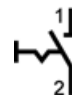

On-off switches with LED

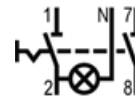

Change over switches

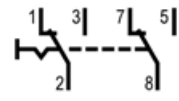
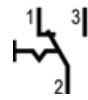

Group switches

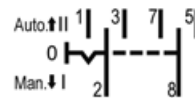
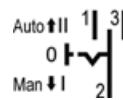

Control switches

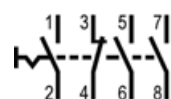
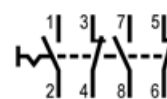

Pushbuttons, indicator lights and accessories

Pushbuttons



Pushbuttons with LED



Indicator lights

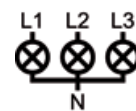
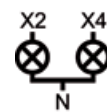

Accessories



Dummy housings (attachable)



for 9 and 18mm

Padlock

Ordering data

On-off switches

On-Off switches, 16 A, 25 A and 32 A

Contact config.	Rated voltage VAC	Power loss W	LED colour	Width mm	Order data Type	Product No.	Bbn 7612270 EAN	Weight per unit kg	Pack. unit
-----------------	-------------------	--------------	------------	----------	-----------------	-------------	-----------------	--------------------	------------



Rated current = 16 A

1 NO	250	0.32	-	9	E211-16-10	2CCA703000R0001	938575	0.035	10
2 NO	250,400	0.82	-	9	E211-16-20	2CCA703005R0001	938582	0.045	10
3 NO	250,400	1.14	-	18	E211-16-30	2CCA703010R0001	938599	0.080	10
4 NO	250,400	1.64	-	18	E211-16-40	2CCA703015R0001	938605	0.090	10



Rated current = 25 A

1 NO	250	0.75	-	9	E211-25-10	2CCA703001R0001	938612	0.035	10
2 NO	250,400	1.95	-	9	E211-25-20	2CCA703006R0001	938629	0.045	10
3 NO	250,400	2.70	-	18	E211-25-30	2CCA703011R0001	938636	0.080	10
4 NO	250,400	3.90	-	18	E211-25-40	2CCA703016R0001	938643	0.090	10

Rated current = 32 A

1 NO	250	1.12	-	9	E211-32-10	2CCA703002R0001	938650	0.035	10
2 NO	250,400	2.73	-	9	E211-32-20	2CCA703007R0001	938667	0.045	10
3 NO	250,400	3.85	-	18	E211-32-30	2CCA703012R0001	938674	0.080	10
4 NO	250,400	5.46	-	18	E211-32-40	2CCA703017R0001	938681	0.090	10

On-Off switches, 16 A and 25 A with switch position indication

Contact config.	Rated voltage VAC	Power loss W	LED colour	Width mm	Order data Type	Product No.	Bbn 7612270 EAN	Weight per unit kg	Pack. unit
-----------------	-------------------	--------------	------------	----------	-----------------	-------------	-----------------	--------------------	------------



Rated current = 16 A

1 NO	250	0.50	■	9	E211X-16-10	2CCA703100R0001	938872	0.040	10
2 NO	250,400	1.00	■	18	E211X-16-20	2CCA703110R0001	938889	0.050	10
3 NO	250,400	1.50	■	18	E211X-16-30	2CCA703115R0001	938896	0.060	10



Rated current = 25 A

1 NO	250	1.15	■	9	E211X-25-10	2CCA703101R0001	938902	0.040	10
2 NO	250,400	2.30	■	18	E211X-25-20	2CCA703111R0001	938919	0.050	10
3 NO	250,400	3.45	■	18	E211X-25-30	2CCA703116R0001	938926	0.060	10

NO = normally-open contact

Change over switches and group switches



Change over switches, 16 A and 25 A

Contact config.	Rated voltage VAC	Power loss W	LED colour	Width mm	Order data Type	Product No.	Bbn 7612270 EAN	Weight per unit kg	Pack. unit
-----------------	-------------------	--------------	------------	----------	-----------------	-------------	-----------------	--------------------	------------

Rated current = 16 A

1 CO	250	0.32	-	9	E213-16-001	2CCA703040R0001	938698	0.041	10
2 CO	250	0.82	-	18	E213-16-002	2CCA703045R0001	938704	0.082	10



Rated current = 25 A

1 CO	250	0.40	-	9	E213-25-001	2CCA703041R0001	938711	0.041	10
2 CO	250	0.88	-	18	E213-25-002	2CCA703046R0001	938728	0.082	10



Group switches I-0-II 16 A and 25 A

Contact config.	Rated voltage VAC	Power loss W	LED colour	Width mm	Order data Type	Product No.	Bbn 7612270 EAN	Weight per unit kg	Pack. unit
-----------------	-------------------	--------------	------------	----------	-----------------	-------------	-----------------	--------------------	------------

Rated current = 16 A

1 CO	250	0.32	-	9	E214-16-101	2CCA703025R0001	938735	0.041	10
2 CO	250	0.82	-	18	E214-16-202	2CCA703030R0001	938742	0.082	10



Rated current = 25 A

1 CO	250	0.40	-	9	E214-25-101	2CCA703026R0001	938759	0.041	10
2 CO	250	0.88	-	18	E214-25-202	2CCA703031R0001	938766	0.082	10

CO = changeover contact

Ordering data

Control switches and pushbuttons



Control switches, 16 A and 25 A

Contact config.	Rated voltage VAC	Power loss W	LED colour	Width mm	Order data Type	Product No.	Bbn 7612270 EAN	Weight per unit kg	Pack. unit
-----------------	-------------------	--------------	------------	----------	-----------------	-------------	-----------------	--------------------	------------

Rated current = 16 A

1NO+1NC 250	0.50	-	-	9	E218-16-11	2CCA703050R0001	938773	0.041	10
2NO+2NC 250	1.00	-	-	18	E218-16-22	2CCA703060R0001	938780	0.082	10
3NO+1NC 250	1.50	-	-	18	E218-16-31	2CCA703065R0001	938797	0.082	10



Rated current = 25 A

1NO+1NC 250	0.75	-	-	9	E218-25-11	2CCA703051R0001	938803	0.041	10
-------------	------	---	---	---	------------	-----------------	--------	-------	----



Pushbutton, 16 A - 6 different pushbutton colours (Pulse contact operation)

Contact config.	Rated voltage VAC	Power loss W	Button colour	Width mm	Order data Type	Product No.	Bbn 7612270 EAN	Weight per unit kg	Pack. unit
-----------------	-------------------	--------------	---------------	----------	-----------------	-------------	-----------------	--------------------	------------

Rated current = 16 A

1NO+1NC 250	0.50	0.50	Grey	9	E215-16-11B	2CCA703150R0001	938810	0.046	10
1NO+1NC 250	0.50	0.50	Red	9	E215-16-11C	2CCA703151R0001	938827	0.046	10
1NO+1NC 250	0.50	0.50	Green	9	E215-16-11D	2CCA703152R0001	938834	0.046	10
1NO+1NC 250	0.50	0.50	Yellow	9	E215-16-11E	2CCA703153R0001	938841	0.046	10
1NO+1NC 250	0.50	0.50	Black	9	E215-16-11F	2CCA703154R0001	938858	0.046	10
1NO+1NC 250	0.50	0.50	Blue	9	E215-16-11G	2CCA703155R0001	938865	0.046	10

NO = normally-open contact

NC = normally-closed contact

Pushbuttons with LED



Pushbutton, 16 A, lit - 5 different LED colours (Pulse contact operation)

Contact config.	Rated voltage VAC	Power loss W	LED colour	Width mm	Order data Type	Product No.	Bbn 7612270 EAN	Weight per unit kg	Pack. unit
-----------------	-------------------	--------------	------------	----------	-----------------	-------------	-----------------	--------------------	------------

Rated LED voltage = 115-250 VAC

1 NO	250	1.10	□	9	E217-16-10B	2CCA703160R0001	938988	0.050	10
1 NO	250	1.10	■	9	E217-16-10C	2CCA703161R0001	938995	0.050	10
1 NO	250	1.10	■	9	E217-16-10D	2CCA703162R0001	939008	0.050	10
1 NO	250	1.10	■	9	E217-16-10E	2CCA703163R0001	939015	0.050	10
1 NO	250	1.10	■	9	E217-16-10G	2CCA703164R0001	939022	0.050	10
1 NC	250	1.10	□	9	E217-16-01B	2CCA703250R0001	939084	0.050	10
1 NC	250	1.10	■	9	E217-16-01C	2CCA703251R0001	939091	0.050	10
1 NC	250	1.10	■	9	E217-16-01D	2CCA703252R0001	939107	0.050	10
1 NC	250	1.10	■	9	E217-16-01E	2CCA703253R0001	939114	0.050	10
1 NC	250	1.10	■	9	E217-16-01G	2CCA703254R0001	939121	0.050	10

Rated LED voltage = 12-48 VAC/DC

1 NO	250	0.72	□	9	E217-16-10B48	2CCA703170R0001	938933	0.050	10
1 NO	250	0.72	■	9	E217-16-10C48	2CCA703171R0001	938940	0.050	10
1 NO	250	0.72	■	9	E217-16-10D48	2CCA703172R0001	938957	0.050	10
1 NO	250	0.72	■	9	E217-16-10E48	2CCA703173R0001	938964	0.050	10
1 NO	250	0.72	■	9	E217-16-10G48	2CCA703174R0001	938971	0.050	10
1 NC	250	0.72	□	9	E217-16-01B48	2CCA703260R0001	939039	0.050	10
1 NC	250	0.72	■	9	E217-16-01C48	2CCA703261R0001	939046	0.050	10
1 NC	250	0.72	■	9	E217-16-01D48	2CCA703262R0001	939957	0.050	10
1 NC	250	0.72	■	9	E217-16-01E48	2CCA703263R0001	939964	0.050	10
1 NC	250	0.72	■	9	E217-16-01G48	2CCA703264R0001	939971	0.050	10

Rated LED voltage = 60-220 VDC

1 NO	250	1.50	□	9	E217-16-10B220	2CCA703165R0001	939138	0.050	10
1 NO	250	1.50	■	9	E217-16-10C220	2CCA703166R0001	939145	0.050	10
1 NO	250	1.50	■	9	E217-16-10D220	2CCA703167R0001	939152	0.050	10
1 NO	250	1.50	■	9	E217-16-10E220	2CCA703168R0001	939169	0.050	10
1 NO	250	1.50	■	9	E217-16-10G220	2CCA703169R0001	939176	0.050	10
1 NC	250	1.50	□	9	E217-16-01B220	2CCA703255R0001	939183	0.050	10
1 NC	250	1.50	■	9	E217-16-01C220	2CCA703256R0001	939190	0.050	10
1 NC	250	1.50	■	9	E217-16-01D220	2CCA703257R0001	939206	0.050	10
1 NC	250	1.50	■	9	E217-16-01E220	2CCA703258R0001	939213	0.050	10
1 NC	250	1.50	■	9	E217-16-01G220	2CCA703259R0001	939220	0.050	10

NO = normally-open contact

NC = normally-closed contact

Ordering data

Indicator lights



Indicator lights with 1 LED - 5 different colours

Contact config.	Rated voltage VAC	Power loss W	LED colour	Width mm	Order data Type	Product No.	Bbn 7612270 EAN	Weight per unit kg	Pack. unit unit
-----------------	-------------------	--------------	------------	----------	-----------------	-------------	-----------------	--------------------	-----------------

Rated LED voltage = 115-250 VAC

-	-	0.47	□	9	E219-B	2CCA703400R0001	939282	0.04	10
-	-	0.47	■	9	E219-C	2CCA703401R0001	939299	0.04	10
-	-	0.47	■	9	E219-D	2CCA703402R0001	939305	0.04	10
-	-	0.47	■	9	E219-E	2CCA703403R0001	939312	0.04	10
-	-	0.47	■	9	E219-G	2CCA703404R0001	939329	0.04	10

Rated LED voltage = 12-48 VAC/DC

-	-	0.40	□	9	E219-B48	2CCA703420R0001	939237	0.04	10
-	-	0.40	■	9	E219-C48	2CCA703421R0001	939244	0.04	10
-	-	0.40	■	9	E219-D48	2CCA703422R0001	939251	0.04	10
-	-	0.40	■	9	E219-E48	2CCA703423R0001	939268	0.04	10
-	-	0.40	■	9	E219-G48	2CCA703424R0001	939275	0.04	10

Rated LED voltage = 60-220 VDC

-	-	1.00	□	9	E219-B220	2CCA703405R0001	939336	0.04	10
-	-	1.00	■	9	E219-C220	2CCA703406R0001	939343	0.04	10
-	-	1.00	■	9	E219-D220	2CCA703407R0001	939350	0.04	10
-	-	1.00	■	9	E219-E220	2CCA703408R0001	939367	0.04	10
-	-	1.00	■	9	E219-G220	2CCA703409R0001	939374	0.04	10

All code colours white, red, green, amber and blue are available for the well-known functions:

Neutral	= white	□
Emergency	= red	■
Normal operation	= green	■
Abnormal operation	= yellow	■
Compelling action	= blue	■

Multiple indicator lights and accessories



Multiple indicator lights with 2 LEDs

Contact config.	Rated volt- age VAC	Power loss W	LED colour	Width mm	Order data Type	Product No.	Bbn 7612270 EAN	Weight per unit kg	Pack. unit unit
-----------------	---------------------------	-----------------	------------	-------------	--------------------	-------------	-----------------------	--------------------------	-----------------------

Rated LED voltage = 115-250 VAC

-	-	0.8	■ ■	9	E219-2CD	2CCA703910R0001	413330	0.042	10
---	---	-----	-----	---	----------	-----------------	--------	-------	----

Rated LED voltage = 12-48 VAC

-	-	0.8	■ ■	9	E219-2CD48	2CCA703911R0001	413347	0.042	10
---	---	-----	-----	---	------------	-----------------	--------	-------	----



Multiple indicator lights with 3 LEDs

Contact config.	Rated volt- age VAC	Power loss W	LED colour	Width mm	Order data Type	Product No.	Bbn 7612270 EAN	Weight per unit kg	Pack. unit unit
-----------------	---------------------------	-----------------	------------	-------------	--------------------	-------------	-----------------------	--------------------------	-----------------------

Rated LED voltage = 415/250 VAC

-	-	1.2	■ ■ ■	9	E219-3C	2CCA703900R0001	413309	0.044	10
-	-	1.2	■ ■ ■	9	E219-3D	2CCA703901R0001	413316	0.044	10
-	-	1.2	■ ■ ■	9	E219-3CDE	2CCA703902R0001	413323	0.044	10



Accessories for the E210 device series

	Width mm	Order data Type	Product No.	Bbn 7612270 EAN	Weight per unit kg	Pack. unit unit
--	-------------	--------------------	-------------	-----------------------	--------------------------	-----------------------

Dummy housings	9	E210-DH	2CCA703480R0001	404208	0.18	10
----------------	---	---------	-----------------	--------	------	----

The modular width of 18 mm must be complied with to use the devices in the SMISSLINE socket system. The dummy housing is ready-made with two expanding connectors. Always snap on dummy housings on the left.



Padlock for 9 and 18 mm wide units		E210-ASV9	2CCA703648R0001	404215		10
---------------------------------------	--	-----------	-----------------	--------	--	----

Technical data

On-off switches

General

Overall depth	68 mm
Width	0.5 or 1 module (9 or 18 mm)
Colour	grey, RAL 7035
Climatic resistance to	IEC 60068-2-2 (dry heat) IEC 60068-2-30 (humid heat) IEC 60068-2-1 (low temperatures)
Ambient temperature	- 25°C to + 55°C
Storage temperature	- 40°C to + 70°C
Connection cross-section (Cu)	from 1 x 1 mm ² to 1 x 6 mm ² or 2 x 2.5 mm ² solid; from 1 x 0.75 mm ² to 2 x 1.5 mm ² flexible with end ferrule or pin cable lug
Tightening torque	1,2-1,5 Nm
Contacts	Double interrupting

On-off switches (E211; E211X)

Short-circuit withstand capacity I_{nc}	3 kA; at 400 V $\cos \varphi = 0.8$ (with fusing ≤ 35 A / NH00)
Rated current I_n	16 A, 25 A, 32 A
Rated voltage U_n	
in accordance with EN	250 VAC, 400 VAC
in accordance UL 508	240 VAC
Rated impulse withstand voltage U_{imp}	6 kV
Lowest operating voltage	24 VAC; 25 mA
Isolating features	to EN60669-2-4; IEC/EN 60947-3
Utilization category	AC-22 A, DC-22 A acc. IEC/EN 60947-3
LED voltage ranges	On-off switches E211X 115-250 VAC (Tolerance +/- 10%)
Frequency	50/60 Hz
Sealable	in the On and Off positions
Standards	DIN EN 60669-1 *VDE 0632-1 DIN EN 60669-2-4 *VDE 0632-2-4 UL 508
Approvals	VDE; UL; GOST; CCC

Utilization category for E211 On-off switches (according to standard IEC 60947-3)

Type	I_n	Utilization category		
		DC-22 A		AC-22 A
E211-16-...	16 A	50 VDC / 16 A	200 VDC / 1 A	400 VAC / 16 A
E211-25-...	25 A	50 VDC / 25 A	200 VDC / 2 A	400 VDC / 25 A
E211-32-...-	32 A	50 VDC / 32 A	200 VDC / 3 A	400 VDC / 32 A

Change over, Group and control switches, pushbuttons and indicator lights

Change over, Group and Control switches (E213; E214; E218)

Rated current I_n	16 A, 25 A
Rated voltage U_n	
in accordance with EN	250 VAC, 400 VAC
in accordance UL 508	240 VAC
Lowest operating voltage	24 VAC; 25 mA
Frequency	50/60 Hz
Switches sealable	in the On and Off positions
Standards	DIN EN 60669-1 *VDE 0632-1 UL 508
Approvals	VDE; UL; GOST; CCC

Pushbuttons without and with LED (E215; E217)

Rated current I_n	16 A
Rated voltage U_n	
in accordance with EN	250 VAC
in accordance UL 508	240 VAC
Lowest operating voltage	24 VAC; 25 mA
LED voltage ranges	12-48 VAC / DC; 115-250 VAC; 60-220 VDC (Tolerance +/- 10%)
Frequency	50/60 Hz
Standards	DIN EN 60669-1 *VDE 0632-1 UL 508
Approvals	VDE; UL; GOST; CCC

Indicator lights (E219)

LED voltage ranges	12-48 VAC / DC; 115-250 VAC; 60-220 VDC (Tolerance +/- 10%)
Frequency	50/60 Hz
Insulation voltage	250 V
Rated impulse withstand voltage U_{imp}	4 kV
Dissipated power	0.47-1 W
Standards	DIN EN 62094-1 UL 508
Approvals	VDE; UL; GOST; *1

Indicator lights with 2 LEDs

LED voltage ranges	115-250 VAC; 12-48 VAC (tolerance +/- 10%)
Frequency	50/60 Hz
Insulation voltage	250 V
Rated impulse withstand voltage U_{imp}	4 kV
Dissipated power	0.8 W
Standards	DIN EN 62094-1
Approvals	VDE; GOST; *1

Indicator lights with 3 LEDs

LED voltage ranges	415/250 VAC (tolerance +/- 10%)
Frequency	50/60 Hz
Insulation voltage	250 V
Rated impulse withstand voltage U_{imp}	4 kV
Dissipated power	1.2 W
Standards	DIN EN 62094-1
Approvals	VDE; GOST; *1

*1 = CCC approval not required

Technical data

On-off switches 16 A and 25 A

On-off switches 16 A



DC switching capacity E211 16 A

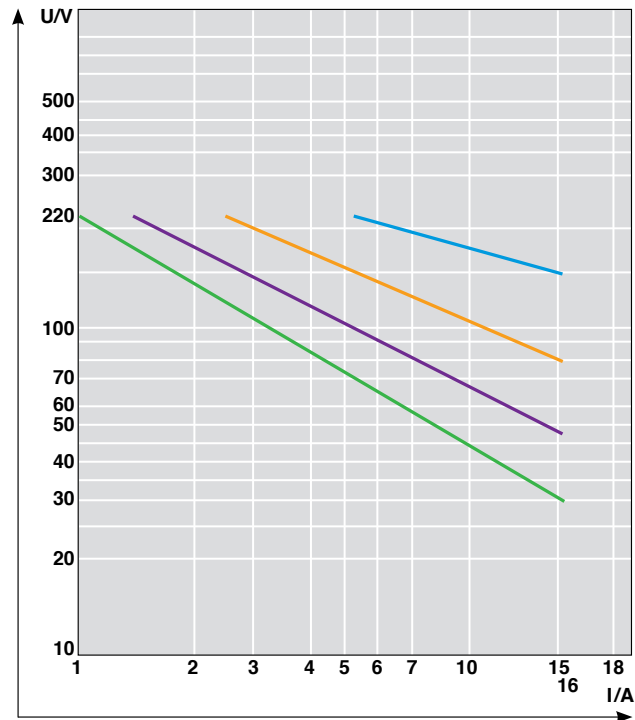

Ohmic load

— Normally-open contact
— Normally-closed contact

Load with time constant
 $t = 15\text{ms}$ (inductive load)

— Normally-open contact
— Normally-closed contact

On-off switches 25 A



DC switching capacity E211 25 A

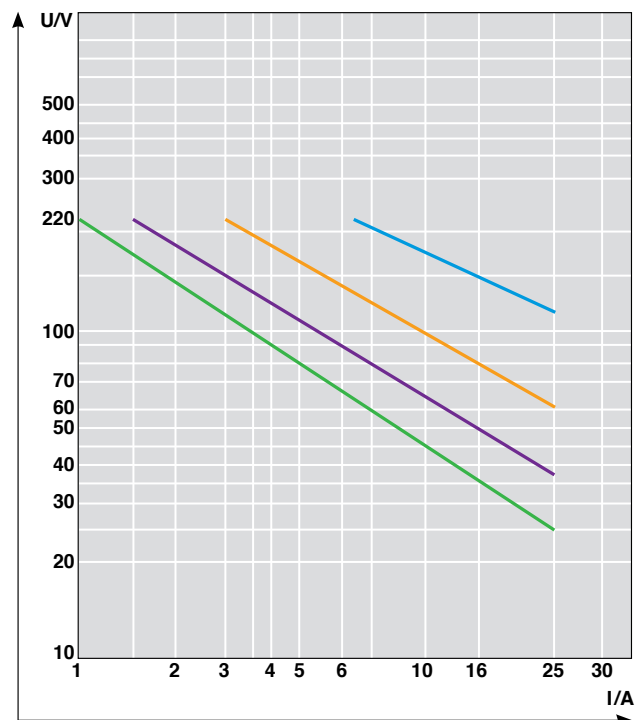

Ohmic load

— Normally-open contact
— Normally-closed contact

Load with time constant
 $t = 15\text{ms}$ (inductive load)

— Normally-open contact
— Normally-closed contact

On-off switches 32 A

On-off switches 32 A



DC switching capacity E211 32 A

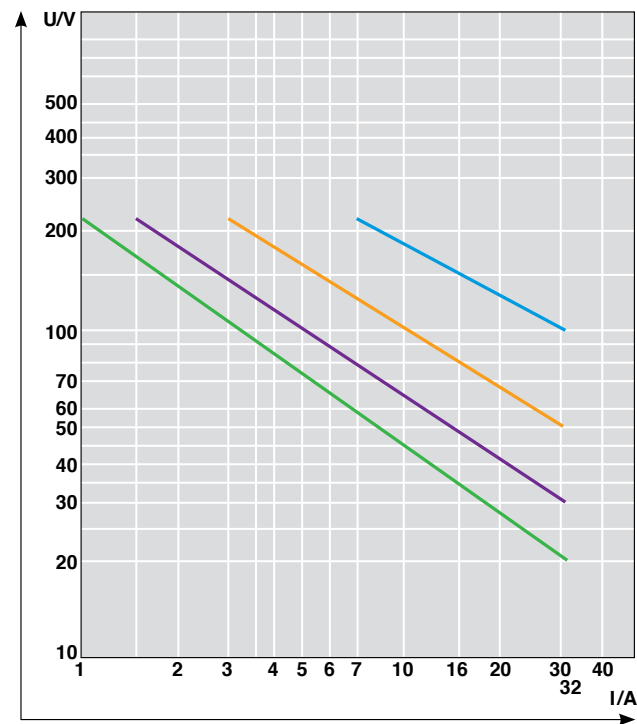

Ohmic load

- Normally-open contact
- Normally-closed contact

Load with time constant
 $t = 15\text{ms}$ (inductive load)

- Normally-open contact
- Normally-closed contact

Technical data

Pushbuttons and indicator lights

Pushbuttons and indicator lights

Overview of general meanings of the colours of operator control parts (excerpt from VDE 0199 or DIN EN 60073).

Colour	Meaning	Explanation	Application examples
RED	Emergency	Action in hazardous situations or emergency	EMERGENCY STOP, STOP or OFF with EMERGENCY STOP pushbutton Initiating an emergency function
YELLOW	Abnormal	Action if an abnormal condition is present	Intervention required to suppress the abnormal condition, manual intervention to restart an interrupted automatic cycle
GREEN	Safety	Action in safe conditions or to prepare a normal condition	Activation
BLUE	Regulation	Status requiring action	Reset function
WHITE GREY BLACK	Non-specific	Functions start	Available for any functions except, except for emergency stop, e.g. ON/OFF; Stop/Start

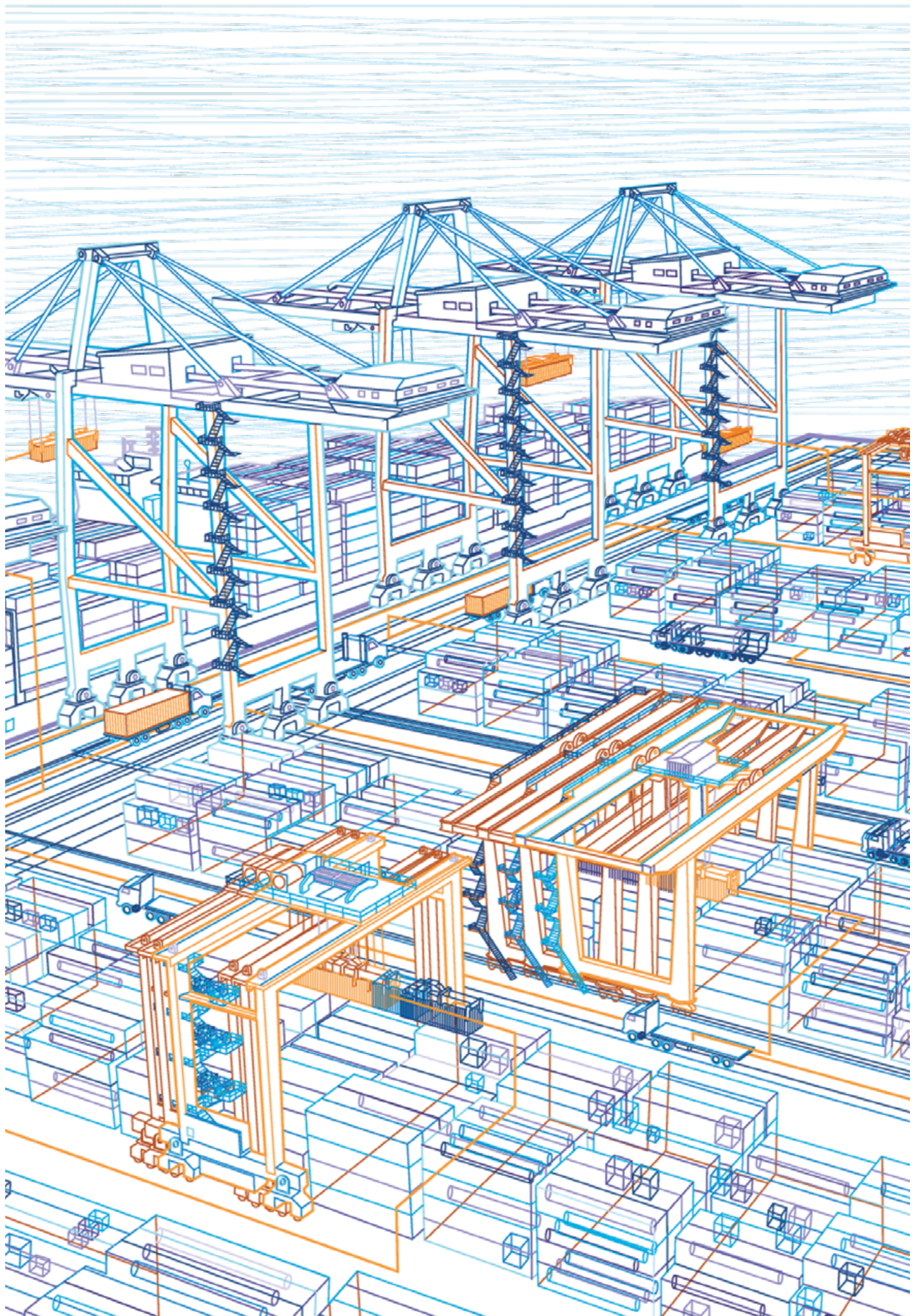

Dimensions (in mm)

Switches

Switches

16 A, 25 A and 32 A

Switch, 1+2-pole

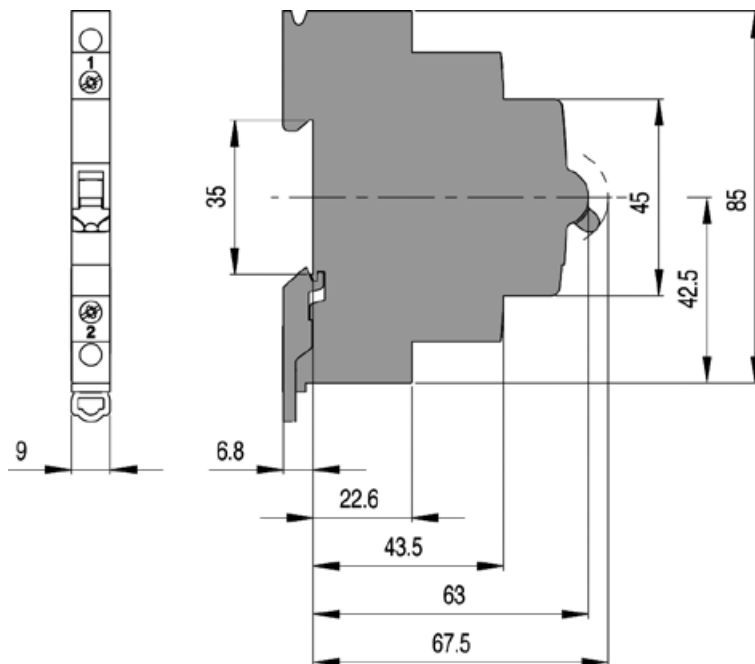

Switch, 3+4-pole

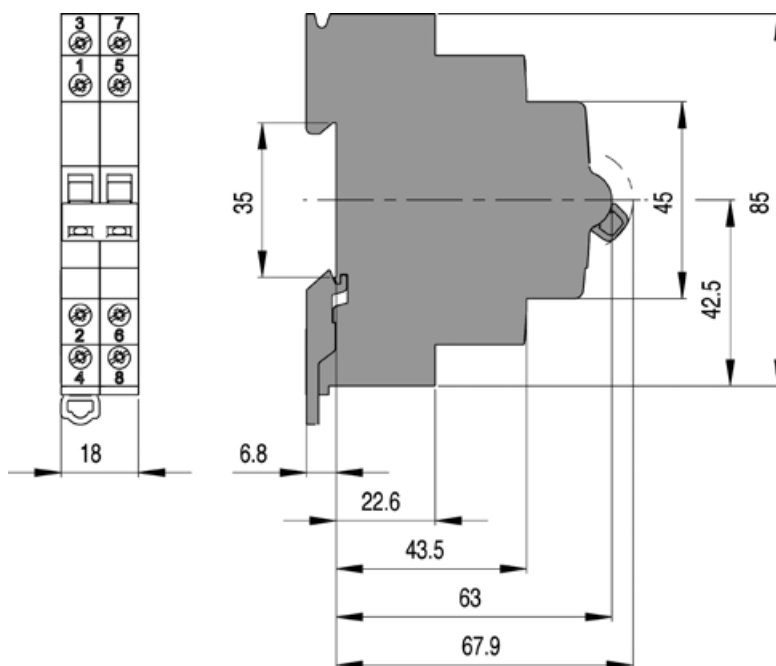

Pushbuttons and indicator lights

Pushbuttons

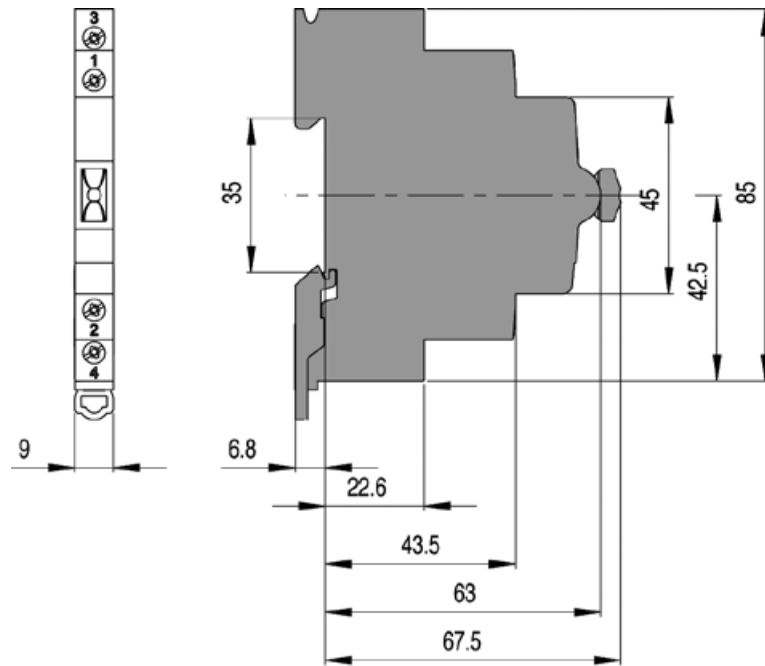



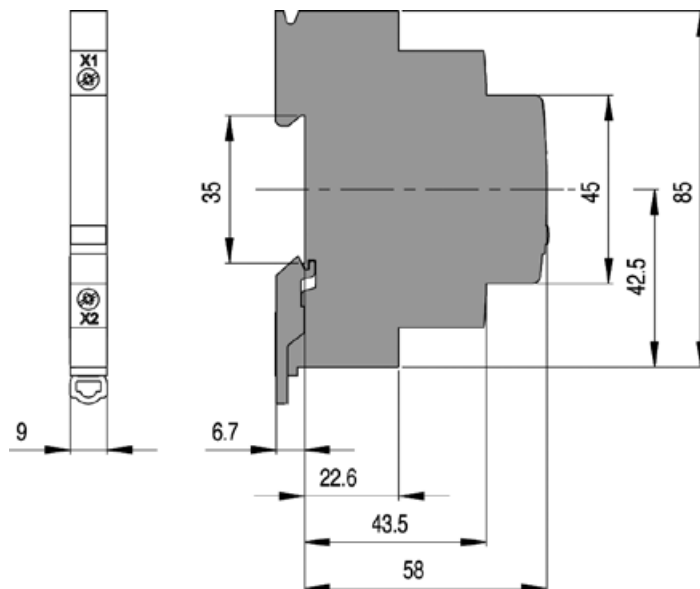







Indicator lights



Approval and standards

Switches, pushbuttons, indicator lights

		Germany	Denmark	Norway	Russia	Switzerland	USA	Poland	China	Shipping classification companies		
		 VDE	 DEMKO	 NEMKO	 GOST	 ESTI	 cURus	 BBJ	 CCC	 RINA	 GL	 LR
Switches	E211	■			■		■		■			
Change over switches	E213	■			■		■		■			
Group switches	E214	■			■		■		■			
Control switches	E218	■			■		■		■			
Pushbuttons	E215	■			■		■		■			
Luminous pushbuttons	E217	■			■		■		■			
Indicator lights (1 LED)	E219	■			■		■		□			
Indicator lights (2 & 3 LEDs)	E219	■			■				□			

- devices are approved
- in preparation
- not required

Contact

Belgium

ABB ELECTRO n.v.
Hoge Wei, 27
1930 Zaventem
Belgium
Telephone +32 (0) 27 18 63 11
Telefax +32 (0) 27 18 66 66

www.abb.be

Brasil

ABB Ltda
Av. dos Autonomistas, 1496
06020-902-Osasco-SP
Brasil
Telephone +55 (0) 80 00 14 91 11
Telefax +55 (11) 36 88 99 77

www.abb.com.br

Czech Republic

ABB s.r.o.
Herspická 13
61900 Brno
Czech Republic
Telephone +420 54 31 45 50 3
Telefax +420 54 32 43 48 9

www.abb.cz/elsynn

Denmark

ABB AS
Meterbuen 33
2740 Skovlunde
Denmark
Telephone +45 44 50 44 50
Telefax +45 44 50 44 60

www.abb.dk

Finland

ABB OY
Domestic Sales
Hiomotie 13
P.O. Box 182
00381 Helsinki
Finland
Telephone +358 10 22 20 00
Telefax +358 10 22 22 91 3

www.abb.fi

France

ABB Entrelec
Division Commercial France
300 rue des Prés Seigneurs
ZA La Boisse – BP 90145
01124 Montluel Cedex
France
Telephone +33 (0) 825 38 63 55
Telefax +33 (0) 825 87 09 26

www.abb.fr

Great Britain

ABB Limited
Tower Court, Foleshill Enterprise Park
Courtaulds Way
CV6 5NX Coventry
GB-United Kingdom
Telephone +44 (0) 24 76 36 85 00
Telefax +44 (0) 24 76 36 44 99

www.abb.co.uk

Ireland

Asea Brown Boveri Ltd.
Belgrad Road, Tallaght
Dublin 24
Ireland
Telephone +35 31 40 57 30 0
Telefax +35 31 40 57 33 2

www.abb.com/lowvoltage

Italy

ABB SACE S.p.A.
Line Protection Devices
Viale dell'Industria, 18
20010 Vittuone (MI)
Italy
Telephone +39 02 90 34 1
Telefax +39 02 90 34 76 09

www.abb.it

Netherlands

ABB b.v.
Automation Products
George Hintzenweg 81
3068 AV Rotterdam
Postbus 301
3000 AH Rotterdam
Netherlands
Telephone +31 (0) 10 40 78 91 1
Telefax +31 (0) 10 40 78 09 0

www.abb.nl

Norway

ABB AS
Jacob Borchsgt. 6
P.O. Box 797 Brakeroya
3002 Drammen
Norway
Telephone +47 32 24 80 00
Telefax +47 32 24 79 34

www.abb.no

Poland

ABB Sp. z o.o.
Automation Products
ul. Zeganska 1
04-713 Warszawa
Poland
Telephone +48 22 51 64 441
Telefax +48 22 51 64 444

www.abb.pl

P.R. China

ABB (China) Ltd
Universal Plaza, 10 Jiuxianqiao Lu
Chaoyang District
100016 Beijing
P.R. China
Telephone +86 10 8456 6688
Telefax +86 10 8456 9907

www.abb.com.cn

Russian Federation

ABB Industrial & Building Systems Ltd.
30/1, bld. 2 Obrucheve St.
117861 Moscow; Russia
Telephone +7 495 960 2200
Telefax +7 495 960 2220

www.abb.ru/ibs

Singapur

ABB Industry Pte Ltd
2 Ayer Rajah Crescent
Singapore 139935
Telephone +65 6776 5711
Telefax +65 6778 0222

www.abb.com.sg

Spain

ABB Automation Products, S.A.
c/Torrent de l'Olla 220
08012 Barcelona
Spain
Telephone +34 93 48 42 10 4
Telefax +34 93 48 42 20 1

www.abb.es

Sweden

ABB Automation
Technologies Cewe Control
Motorgrad 20
72161 Västerås
Sweden
Telephone +46 (0) 21 32 07 00
Telefax +46 (0) 21 12 60 01

www.abb.se

ABB Switzerland Ltd.

CMC Low Voltage Products
Fulachstrasse 150
CH-8201 Schaffhausen
Tel. +41 (0)58 586 41 11
Fax +41 (0)58 586 42 22
E-mail: cmc@ch.abb.com

www.abb.ch

Thailand

ABB LIMITED
161/1 SG Tower, 1st-4th Floor,
Soi Mahadlekluang 3,
Rajdamri Road, Lumpini, Pathumwan,
Bangkok 10330
Thailand
Telephone +66 (0) 2665 1000
Telefax +66 (0) 2665 1043

www.abb.co.th

Ukraine

ABB Ltd, Ukraine
Automation Products Low Voltage
4, Ivana Lepse Blvd.
Kiev 67, 03680
Ukraine
Telephone +380 44 495 22 11
Telefax +380 44 495 22 10

www.abb.ua

Due to possible changes in regulatory requirements and materials, the characteristics and dimensions stated in this catalogue are only to be considered as binding after confirmation from ABB.