

Altivar 61/71

EtherNet/IP™ card

User manual

VW3 A3 316

11/2010

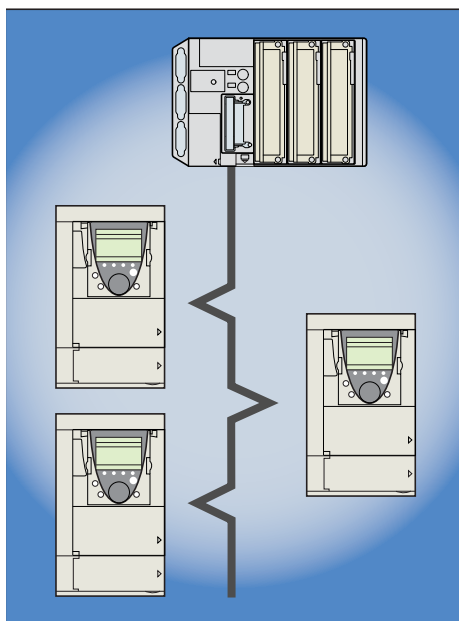

Table of Contents

1. Important Information	4
2. Before you begin	5
3. Documentation structure	6
4. Introduction	7
4. 1. Presentation	7
4. 2. Notation	7
5. Hardware setup	8
5. 1. Receipt	8
5. 2. Hardware description	8
5. 3. Installing the card in the drive	8
6. Connecting to the EtherNet/IP network	9
6. 1. Card RJ45 connector pinout	9
6. 2. Example of connection to an EtherNet/IP network	9
7. Using the HMI with the EtherNet/IP card	10
7. 1. Access to EtherNet/IP menu via graphic display terminal	10
7. 2. Access to EtherNet/IP menu via the integrated display terminal	10
7. 3. Ethernet/IP configuration with the HMI	11
7. 4. Detail of the configured parameters	12
7. 5. Assemblies and scanner configuration	12
8. Configuration of the assemblies	13
8. 1. Configuration of the assemblies: overview	13
8. 2. Configuration of the assembly (100,101) Telemecanique native profile	14
8. 3. Configuration of the assembly (103,104) Allen Bradley® profile	15
8. 4. Configuring the communication scanner	16
8. 5. Configuring the control	17
9. Fault management	22
9. 1. Fault management	22
9. 2. Status of the LEDs	23
10. Configuration of monitored parameters	24
11. Webserver	25
11. 1. Opening the Altivar home page	25
11. 2. Web pages structure	25
11. 3. Drive	26
11. 4. Network setup	29
11. 5. Diagnostics	32
12. Integration in RSLogix	34
12. 1. Principle	34
12. 2. Procedure	34
12. 3. Registering the EDS file in RSLogix	41
13. CIP objects	44
13. 1. Supported object classes	44
13. 2. Identity object	44
13. 3. Message router object	45
13. 4. Ethernet Link object	47
13. 5. TCP/IP Interface object	50
13. 6. Connection object manager	52
13. 7. Motor data object	53
13. 8. Control supervisor object	54
13. 9. AC/DC Drive Object	56
13. 10. Assembly object	57
13. 11. Application objects	58
14. Explicit Messaging	60
15. Device profiles	61
16. Configuring an ATV71/61 in replacement of a Powerflex® drive	70

1. Important Information

NOTICE

Read these instructions carefully, and look at the equipment to become familiar with the device before trying to install, operate, or maintain it. The following special messages may appear throughout this documentation or on the equipment to warn of potential hazards or to call attention to information that clarifies or simplifies a procedure.



The addition of this symbol to a Danger or Warning safety label indicates that an electrical hazard exists, which will result in personal injury if the instruction are not followed.



This is the safety alert symbol. It is used to alert you to potential personal injury hazards. Obey all safety messages that follow this symbol to avoid possible injury or death.

DANGER

DANGER indicates an imminently hazardous situation, which, if not avoided, **will result** in death, serious injury, or equipment damage.

WARNING

Warning indicates a potentially hazardous situation, which, if not avoided, **can result** in death, serious injury, or equipment damage.

CAUTION

CAUTION indicates a potentially hazardous situation, which, if not avoided, **can result** in injury or equipment damage.

PLEASE NOTE

Electrical equipment should be serviced only by qualified personnel. No responsibility is assumed by Schneider Electric for any consequences arising out of the use of this material. This document is not intended as an instruction manual for untrained persons.
© 2006 Schneider Electric. All Rights Reserved.

2. Before you begin

Read and understand these instructions before performing any procedure with this drive.

DANGER

HAZARDOUS VOLTAGE

- Read and understand this bulletin in its entirety before installing or operating Altivar 71 drive. This equipment must only be installed, adjusted, repaired, and maintained by qualified personnel.
- The user is responsible for compliance with all international and national electrical standards in force concerning protective grounding of all equipment.
- Many parts of this variable speed drive, including the printed circuit boards, operate at the line voltage. DO NOT TOUCH. Use only electrically insulated tools.
- DO NOT touch unshielded components or terminal strip screw connections with voltage present.
- DO NOT short across terminals PA and PC or across the DC bus capacitors.
- Install and close all the covers before applying power or starting and stopping the drive.
- Before servicing the variable speed drive
 - Disconnect all power.
 - Place a "DO NOT TURN ON" label on the variable speed drive disconnect.
 - Lock the disconnect in the open position.
- Disconnect all power including external control power that may be present before servicing the drive. WAIT 15 MINUTES to allow the DC bus capacitors to discharge. Then follow the DC bus voltage measurement procedure given in the Installation Manual to verify that the DC voltage is less than 45 VDC. The drive LEDs are not accurate indicators of the absence of DC bus voltage.

Failure to follow these instructions will result in death or serious injury.

WARNING

DAMAGED EQUIPMENT

Do not install or operate any drive or drive accessory that appears damaged. The relays, inputs, or outputs of a damaged drive may not operate in a normal manner, leading to unintended equipment operation.

Failure to follow this instruction can result in death, serious injury, or equipment damage.

WARNING

LOSS OF CONTROL

- The designer of any control scheme must consider the potential failure modes of control paths and, for certain critical control functions, provide a means to achieve a safe state during and after a path failure. Examples of critical control functions are emergency stop and overtravel stop.
- Separate or redundant control paths must be provided for critical control functions.
- System control paths may include communication links. Consideration must be given to the implications of unanticipated transmission delays or failures of the link.*
- Each implementation of an Altivar 71 Modbus TCP/IP EtherNet/IP card must be individually and thoroughly tested for proper operation before being placed into service.

Failure to follow this instruction can result in death, serious injury, or equipment damage.

* For additional information, refer to NEMA ICS 1.1 (latest edition), "Safety Guidelines for the Application, Installation, and Maintenance of Solid State Control" and to NEMA ICS 7.1 (latest edition), "Safety Standards for Construction and Guide for Selection, Installation and Operation of Adjustable-Speed Drive Systems".

3. Documentation structure

The following Altivar 71 technical documents are available on the Web site www.schneider-electric.com.

■ Installation Manual

This manual describes:

- How to assemble the drive.
- How to connect the drive.

■ Programming Manual

This manual describes:

- The functions.
- The parameters.
- How to use the drive display terminal (integrated display terminal and graphic display terminal).

■ Communication Parameters Manual

This manual describes:

- The drive parameters with specific information (addresses, formats, etc.) for use via a bus or communication network.
- The operating modes specific to communication (state chart).
- The interaction between communication and local control.

■ Modbus, CANopen[®], Ethernet[™], Profibus, INTERBUS, Uni-Telway, DeviceNet[™], Modbus Plus, Fipio, etc., manuals.

These manuals describe:

- Connection to the bus or network.
- Configuration of the communication-specific parameters via the integrated display terminal or the graphic display terminal.
- Diagnostics.
- Software setup.
- The communication services specific to the protocol.

■ Altivar 58/58F Migration Manual

This manual describes the differences between the Altivar 71 and the Altivar 58/58F.

It explains how to replace an Altivar 58 or 58F, including how to replace drives communicating on a bus or network.

4. Introduction

4. 1. Presentation

The EtherNet/IP card (catalog number VW3 A3 316) is used to connect an Altivar 71 or an Altivar 61 drive to an Ethernet network using the EtherNet/IP protocol.

IMPORTANT : This communication option card is fully supported with the version V1.5 IE 13 and above of the Altivar 61 firmware. This communication option card is only supported with the version V1.6 IE 19 and above of the Altivar 71 firmware. Specific versions of the Altivar 71 firmware are not supported.

The VW3 A3 316 card is equipped with two shielded RJ45 EtherNet/IP connectors.

The accessories for connection to the EtherNet/IP network must be ordered separately.

The data exchanges permit full drive functionality:

- Configuration
- Adjustment
- Control
- Monitoring
- Diagnostics

The standard Web server (English only) provides access to the following pages:

- Altivar Viewer
 - Data Viewer
 - EtherNet/IP
 - Security
- Etc.

The graphic display terminal or the integrated display terminal can be used to access numerous functions for communication diagnostics.

4. 2. Notation

Drive terminal displays

The graphic display terminal menus are shown in square brackets.

Example: [1.9 COMMUNICATION].

The integrated 7-segment display terminal menus are shown in round brackets.

Example: (C □ Π -).

The parameter names displayed on the graphic display terminal are shown in square brackets.

Example: [Fallback speed].

The parameter codes displayed on the integrated 7-segment display terminal are shown in round brackets.

Example: (L F F).

Formats

Hexadecimal values are written as follows: 16#

Binary values are written as follows: 2#

PC-Software: Commissioning Software

5. Hardware setup

5. 1. Receipt

- Check that the card catalog number marked on the label is the same as that on the delivery note corresponding to the purchase order.
- Remove the option card from its packaging and check that it has not been damaged in transit.

⚠ CAUTION

STATIC SENSITIVE COMPONENTS

The EtherNet/IP card can be damaged by static electricity. Observe electrostatic precautions when handling and installing the card.

Failure to follow this instruction can result in equipment damage.

5. 2. Hardware description

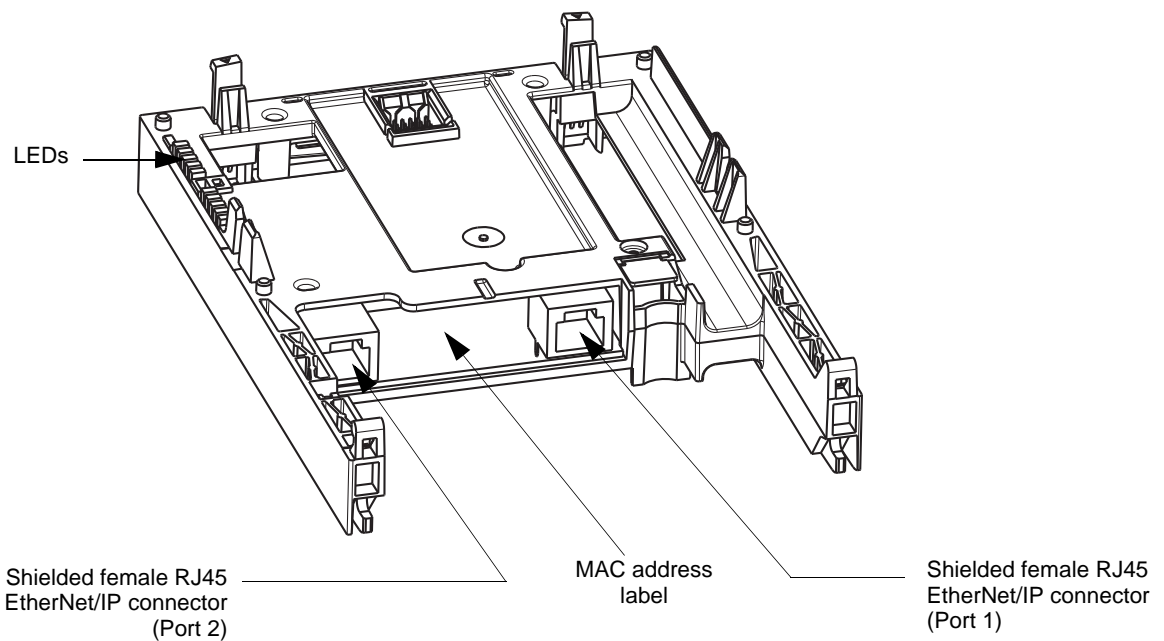

5. 3. Installing the card in the drive

See the Installation Manual.

6. Connecting to the EtherNet/IP network

6. 1. Card RJ45 connector pinout

The EtherNet/IP card is equipped with two shielded RJ45 connectors. The shielding is connected to the drive ground. Use an STP (shielded twisted pair) EtherNet/IP cable.

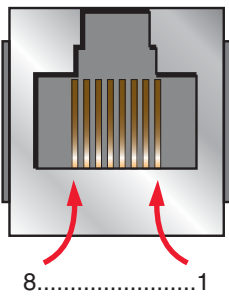

Pin	Signal
1	TD+
2	TD-
3	RD+
4	
5	
6	RD-
7	
8	

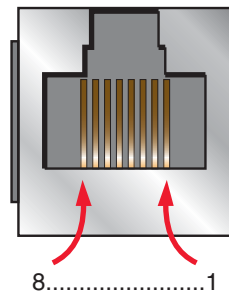

The transmission speed is detected automatically by the card (10 Mbps or 100 Mbps).

The card can operate in half duplex or full duplex mode, whether connected to a hub or a switch and regardless of the transmission speed (10 Mbps or 100 Mbps).

6. 2. Example of connection to an EtherNet/IP network

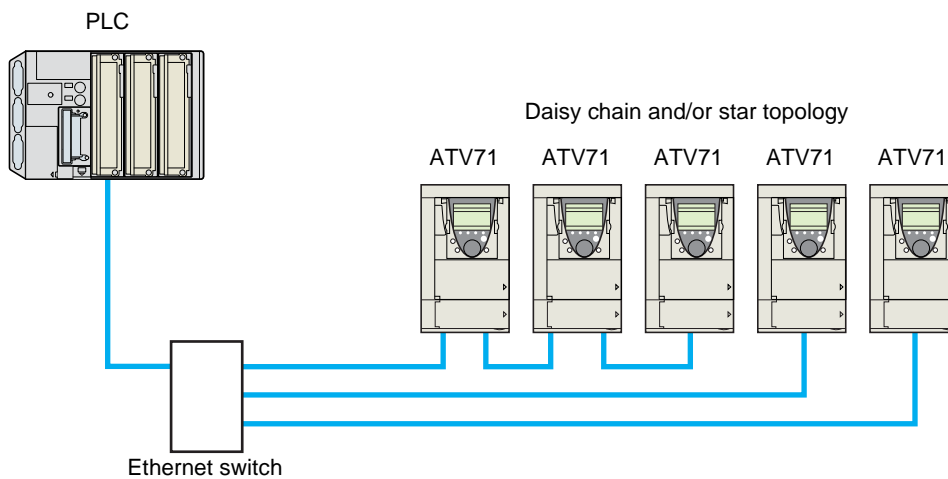

7. Using the HMI with the EtherNet/IP card

7. 1. Access to EtherNet/IP menu via graphic display terminal

The [EtherNet/IP] submenu is used to configure and display the EtherNet/IP card parameters and can be accessed via the [1.9 - COMMUNICATION] menu.

This menu is only accessible in standard, advanced and expert mode: In the [2 ACCESS LEVEL] (L A C -) menu, set the level to [expert] (E P r).

Can be accessed by the other level.

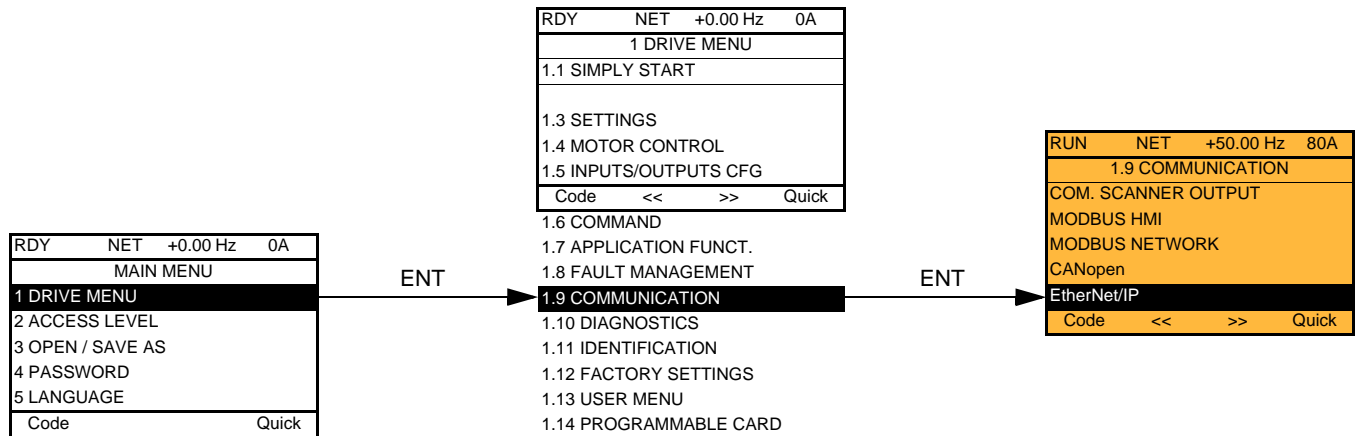

7. 2. Access to EtherNet/IP menu via the integrated display terminal

The (E L H -) submenu is used to configure and display the EtherNet/IP card parameters. It can be accessed via the (C O N -) menu.

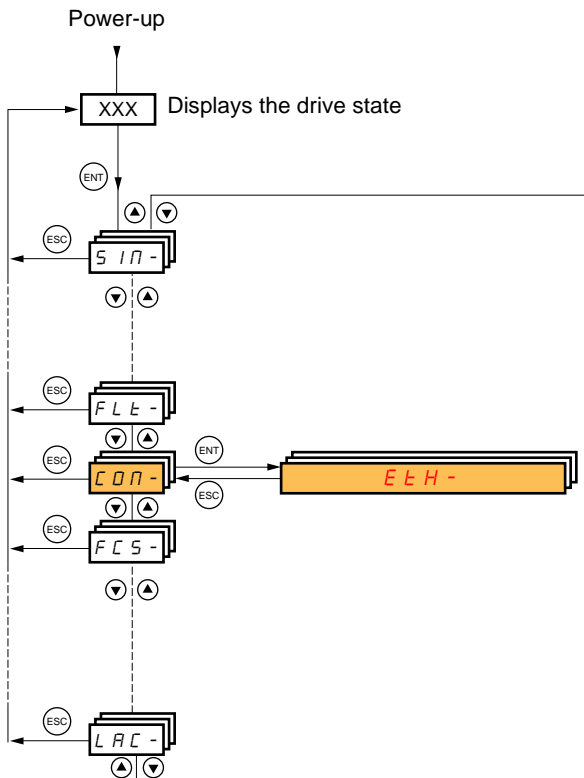

7. Using the HMI with the EtherNet/IP card

7.3. Ethernet/IP configuration with the HMI

Detail of the Ethernet/IP configuration menu: (All these settings can also be performed from the webserver or PC-Software). In the table, parameters which are not followed by their parameter code (between parenthesis) are not displayed on the 7 segment display of the drive. [1.9 - COMMUNICATION] (C 0 0 -) → menu [ETHIP] (E E h)

Parameter	Possible value	Terminal display
[DEVICE NAME] The device name is required if the card uses DHCP to obtain its IP Address.	16 chars.	[ABC...]
[Rate Setting] (r d 5) This field is used to set the transmission speed and the transmission mode of the card.	0 : Autodetect (default) 1 : 10 Mbps Full 2 : 10 Mbps Half 3 : 100 Mbps Full 4 : 100 Mbps Half (do not use)	[Auto] (A U E 0) [10 Mbps full] (1 0 F) [10 Mbps half] (1 0 H) [100 Mbps full] (1 0 0 F) [100 Mbps half] (1 0 0 H)
[Actual Rate] (R r d) This field displays the baud rate and the transmission mode currently used by the communication card. (Display only)	0 : Autodetect 1 : 10 Mbps Full 2 : 10 Mbps Half 3 : 100 Mbps Full 4 : 100 Mbps Half	[Auto] (A U E 0) [10 Mbps full] (1 0 F) [10 Mbps half] (1 0 H) [100 Mbps full] (1 0 0 F) [100 Mbps half] (1 0 0 H)
[IP mode] (I P 0) Use this parameter to select the IP address assignment method.	0 : Manu 1 : BOOTP 2 : DHCP	[fixed] (P R 0 U) [BOOTP] (b 0 0 t) [DHCP] (d H C P)
[IP card] (I P C -) (I P C 1) (I P C 2) (I P C 3) (I P C 4) IP address of the card	These fields are <u>editable</u> when IP mode is set to Fixed address	[139.160.069.241] (1 3 9) (1 6 0) (0 6 9) (2 4 1)
[IP Mask] (I P 0 -) (I P 0 1) (I P 0 2) (I P 0 3) (I P 0 4) Subnet mask	These fields are <u>editable</u> when IP mode is set to Fixed address	[255.255.254.0] (2 5 5) (2 5 5) (2 5 4) (0)
[IP Gate] (I P G -) (I P G 1) (I P G 2) (I P G 3) (I P G 4) Default gateway IP address	These fields are <u>editable</u> when IP mode is set to Fixed address	[0.0.0.0] (0) (0) (0) (0)
<ul style="list-style-type: none"> • If the address has been given by a BOOTP or a DHCP server, these fields are read only. • After dynamic addressing by a BOOTP or DHCP server, the new address value is displayed. 		
[Services] (E E) Enables web server and e-mail server * This parameter is significant at the bit level. Bit 0 and bit, other bits are reserved	0 : Web Server and Email functions are disabled. 1: Web Server activated. 2: Email function activated 3: Web server and Email functions are activated	0 1 2 3
[MAC @] MAC address display	[00-80-F4-XX-XX-XX]	[00-80-F4-XX-XX-XX]

*: This functionality can only be configured from the WEB server or from commissioning software.

7. Using the HMI with the EtherNet/IP card

7. 4. Detail of the configured parameters

■ IP address

Assigning IP addresses

The drive needs 3 IP addresses:

- The drive IP address.
- The subnet mask.
- The gateway IP address.

They can be provided by:

- A BOOTP server (correspondence between the MAC address and the IP addresses).
- Or a DHCP server (correspondence between Device Name [\[DEVICE NAME\]](#) and the IP addresses).

The address is assigned according to the IPmode parameter:

IP Mode value	Comments
IP mode = 0	The card uses the address defined in IPC1, IPC2, IPC3, IPC4
IP mode = 1	The card receives its address from a BOOTP server
IP mode = 2	The card receives its address from a DHCP server
And Device name contains a valid name.	

IMPORTANT: The IP mode parameter may be modified according to the **configuration control attribute** of the **TCP/IP interface object** (CIP standard). See page [50](#).

7. 5. Assemblies and scanner configuration

The assemblies are chosen at the master controller level (see for example chapter 16 Integration in RSlogix).

For the 4 ODVA set of assemblies (20,21,22,23,70,71,72,73) there are no more configuration to do at the communication scanner level.

For the Telemecanique assembly (100,101) and Allen Bradley® assembly (103,104) you must:

- configure at the drive level the size of the assembly,
- define the mapping of the additional parameters.

8. Configuration of the assemblies

8. 1. Configuration of the assemblies: overview

VW3 A3 316 EtherNet/IP communication card
Features overview

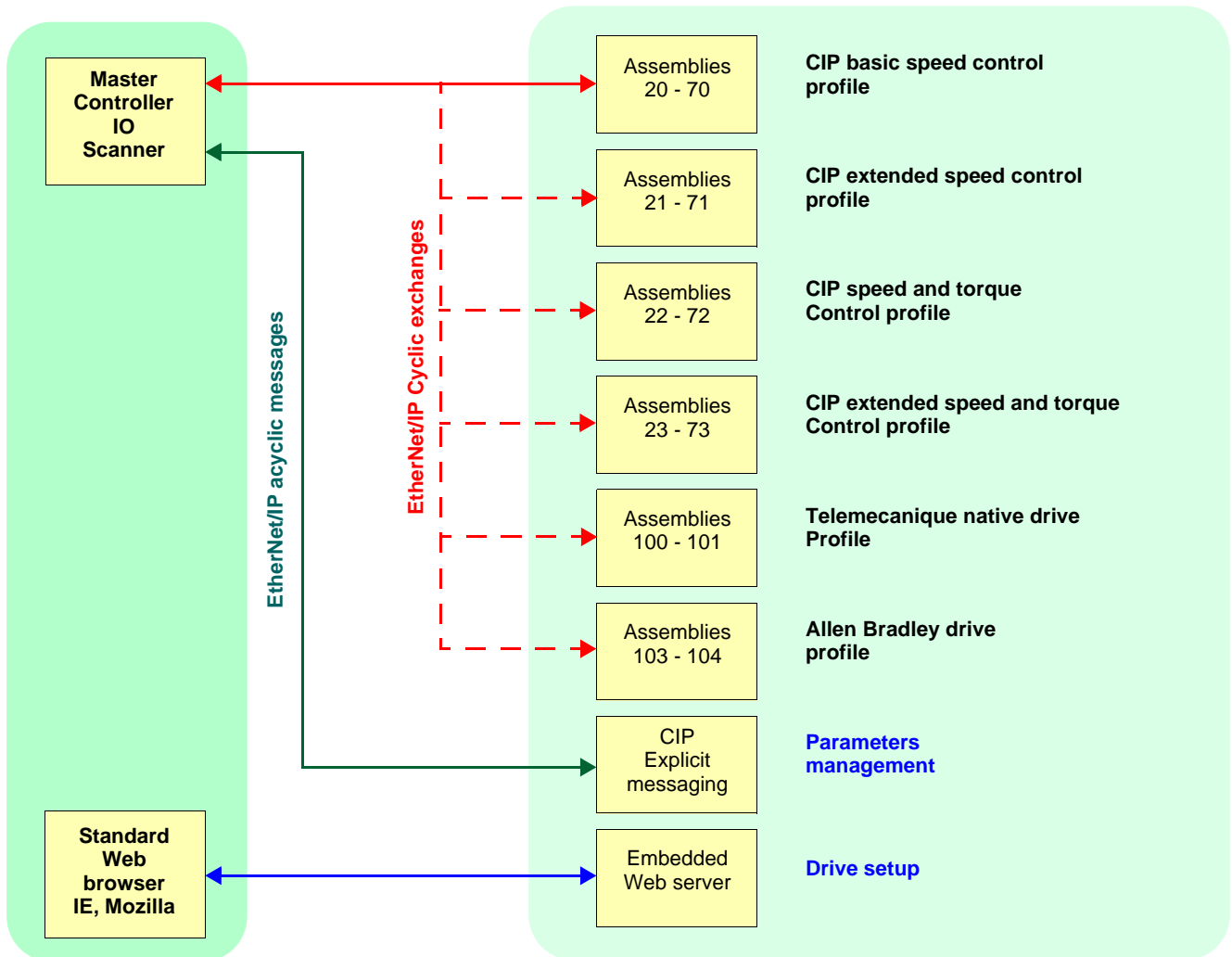

8. Configuration of the assemblies

8.2. Configuration of the assembly (100,101) Telemecanique native profile

The size of the assembly is fixed and is equal to 8.

The mapping of the other parameters is made with the communication scanner :

The configuration of the addresses defined with NCAx and NMAx can be made with the graphic keypad:

For assembly 100 : [1.9- COMMUNICATION] (**C D N -**) menu, [COM.SCANNER OUTPUT] (**D E S -**) submenu.

For assembly 101 : [1.9- COMMUNICATION] (**C D N -**) menu, [COM.SCANNER INPUT] (**I E S -**) submenu.

See menu [1.2 MONITORING] > COMMUNICATION MAP to monitor the communication scanner.

See also "Configuring the communication scanner" page 16.

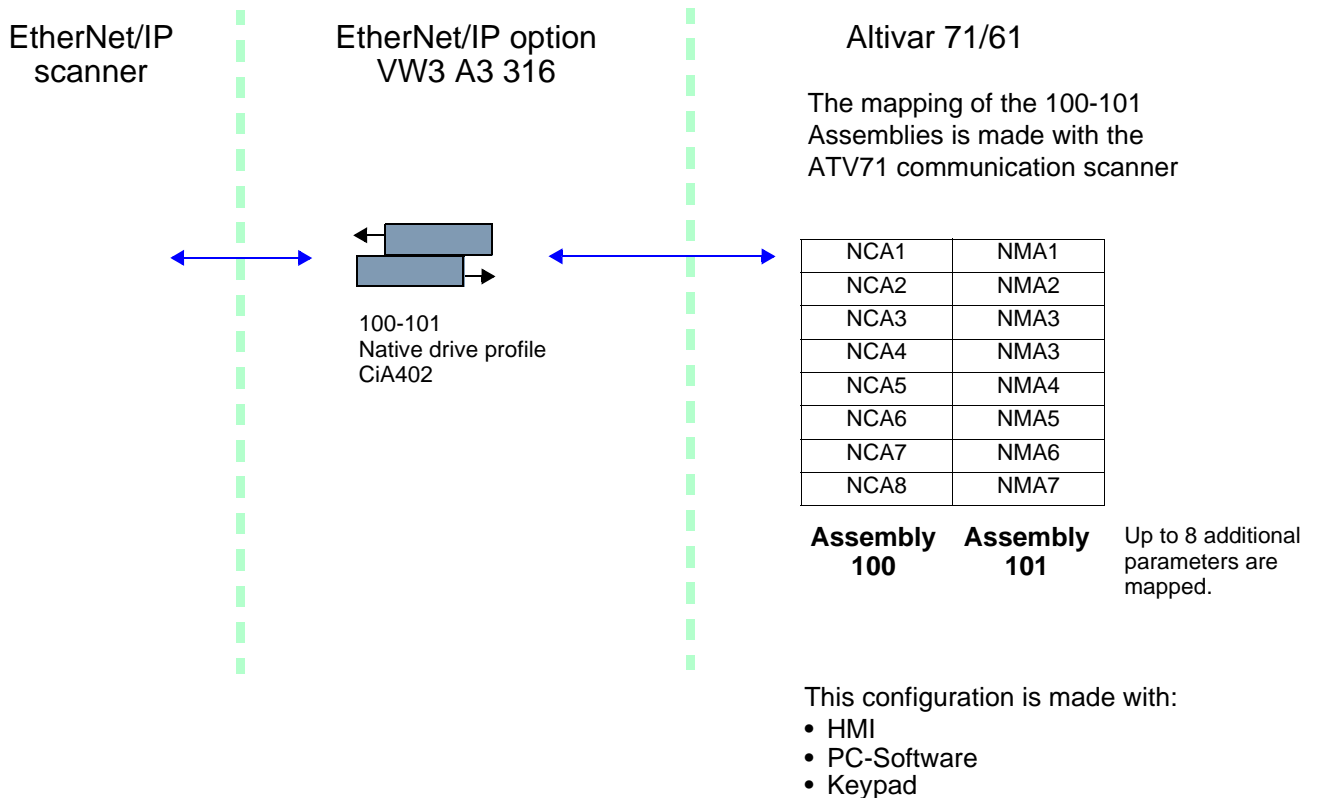

Here is an example of the configuration of the assemblies 100, 101 from RSLogix software:

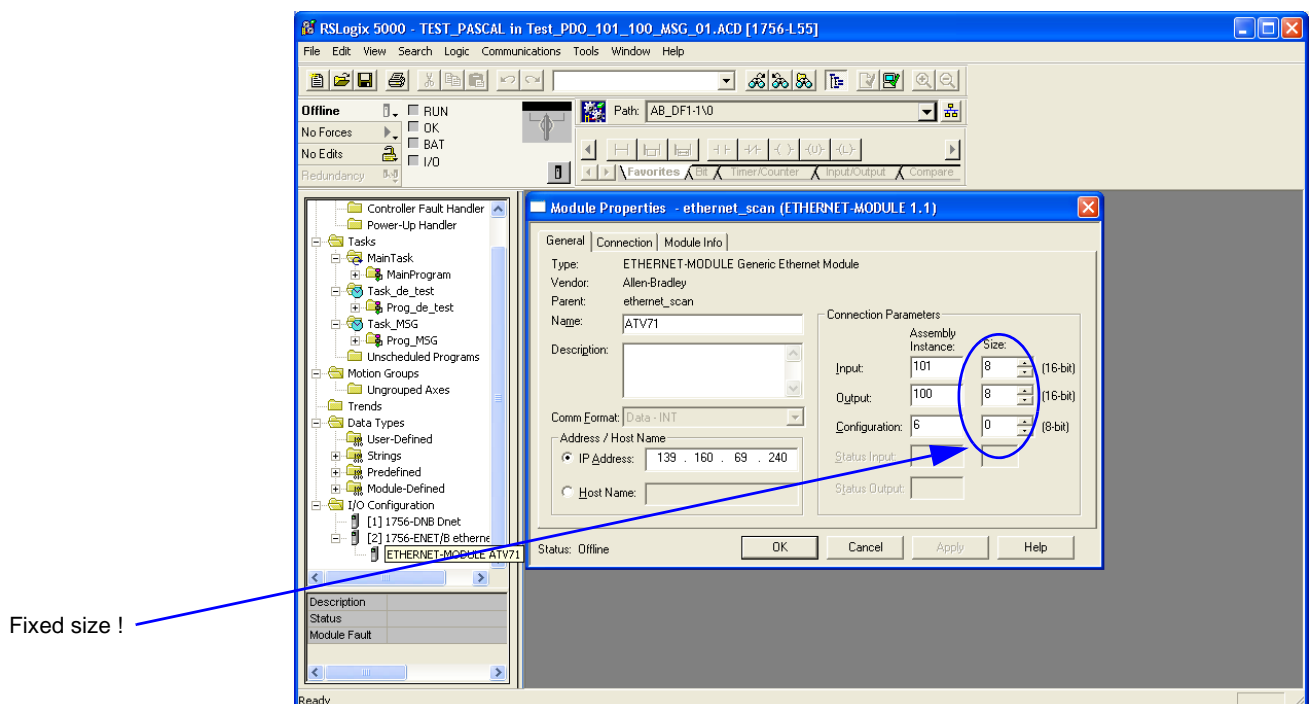

8. Configuration of the assemblies

8.3. Configuration of the assembly (103,104) Allen Bradley® profile

The size of the assembly is selectable from 2 to 10 words.

The 2 first words of the input assembly are fixed: Control word, Speed setpoint.

The 4 first words of the output assembly are fixed two pad words: Status word, Actual Speed.

IMPORTANT: NCA1 and NCA2 are already configured (default settings of the drive). It is important when configuring this assembly set to handly remove the default assignment of NCA1 and NCA2: By setting NCA1 and NCA2 to a null address or by configuring this two address to other required parameters of the drive.

This will avoid a conflict between NCA1 and the control word of the profile (located in the first word of the assembly 103).

The configuration of the addresses defined with NCAx and NMAx can be made with the graphic keypad:

For assembly 103 : [1.9- COMMUNICATION] (C O N -) menu, [COM.SCANNER OUTPUT] (O C S -) submenu.

For assembly 104 : [1.9- COMMUNICATION] (C O N -) menu, [COM.SCANNER INPUT] (I C S -) submenu.

See menu [1.2 MONITORING] > COMMUNICATION MAP to monitor the communication scanner.

See also "Configuring the communication scanner" page 16

The mapping of the other parameters is made with the EtherNet/IP scanner:

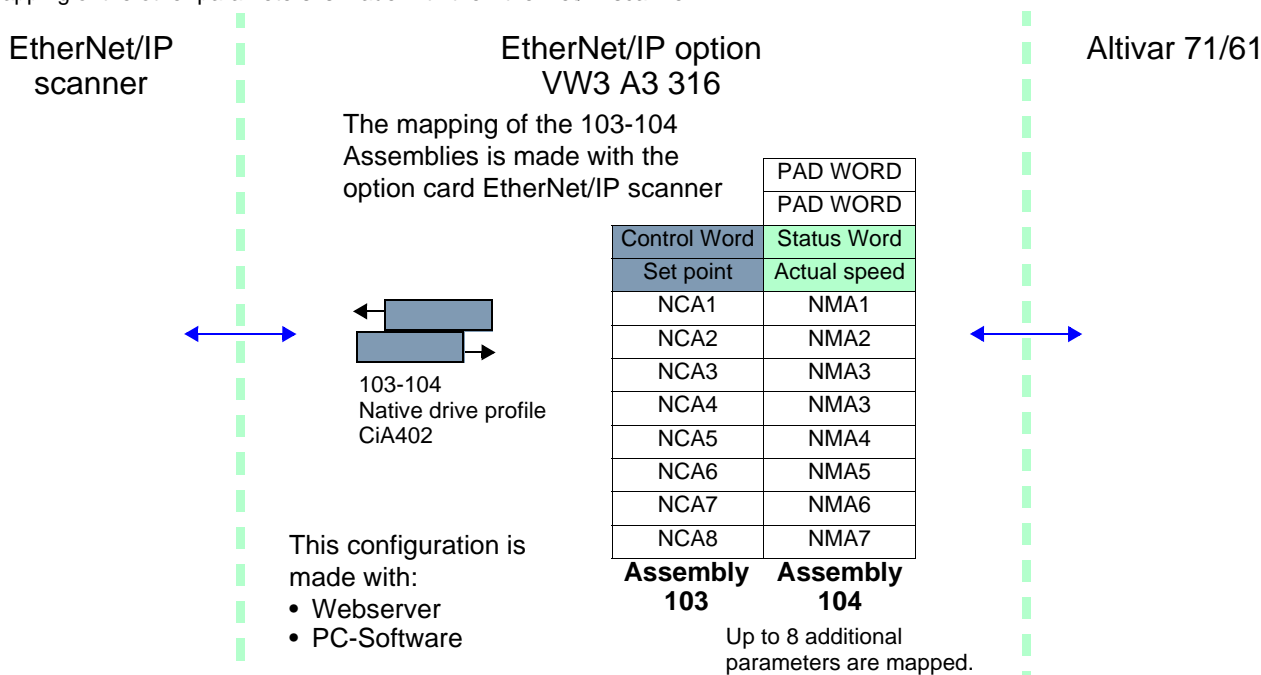

Here is an example of the configuration of the assemblies 103, 104 from RSLogix software

The sizes indicated must be adjusted according to the settings defined with the EtherNet/IP scanner setup (webservice or PC-Software).

Note:

- The size of the assembly cannot be modified dynamically; such change requires a power ON.
- Given that assemblies 103 and 104 uses NCAx and NMAx, the configuration edited with the webservice or PC-Software are also applied to the communication scanner of the drive (like assemblies 100 and 101).

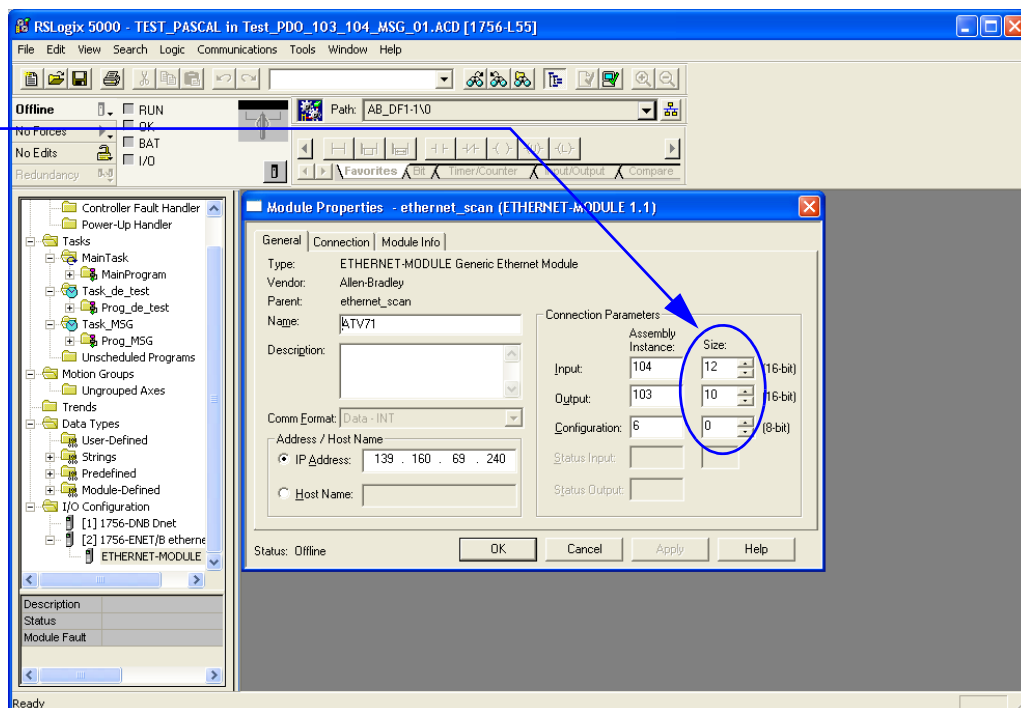

8. Configuration of the assemblies

8. 4. Configuring the communication scanner

You need to read this chapter only if you use the assemblies 100 or 101 that use the drive communication scanner.

The variables exchanged by the output assembly 100 and input assembly 101 are selected by configuring the communication scanner.

The 8 output variables are assigned by means of the 8 parameters [Scan. Out● address] (n L R ●). They are configured using the graphic display terminal via the [1.9 - COMMUNICATION] (L O P -) menu, [COM. SCANNER OUTPUT] (O C S -) submenu.

The 8 input variables of the assembly 101 are assigned by means of the 8 parameters [Scan. In● address] (n P R ●). They are configured using the graphic display terminal via the [1.9 - COMMUNICATION] (L O P -) menu, [COM. SCANNER INPUT] (I C S -) submenu.

Enter the logic address of the parameter (see the Communication parameters manual).

If a parameter [Scan. Out● address] (n L R ●) or [Scan. In● address] (n P R ●) is equal to zero, the corresponding period variable is not used by the drive.

These 8 assignment parameters are described in the tables below:

Parameter name	Output assembly 100	Default assignment
[Scan. Out1 address] (n L R 1)		NCA1 = 8501
[Scan. Out2 address] (n L R 2)		NCA2 = 8602
[Scan. Out3 address] (n L R 3)		NCA3 = not used
[Scan. Out4 address] (n L R 4)		NCA4 = not used
[Scan. Out5 address] (n L R 5)		NCA5 = not used
[Scan. Out6 address] (n L R 6)		NCA6 = not used
[Scan. Out7 address] (n L R 7)		NCA7 = not used
[Scan. Out8 address] (n L R 8)		NCA8 = not used

Parameter name	Input assembly 101	Default assignment
[Scan. In1 address] (n P R 1)		NMA1=3201
[Scan. In2 address] (n P R 2)		NMA2=8604
[Scan. In3 address] (n P R 3)		NMA3=not used
[Scan. In4 address] (n P R 4)		NMA4=not used
[Scan. In4 address] (n P R 5)		NMA5=not used
[Scan. In4 address] (n P R 6)		NMA6=not used
[Scan. In4 address] (n P R 7)		NMA7=not used
[Scan. In4 address] (n P R 8)		NMA8=not used

Example of configuration via the graphic display terminal:

RDY	NET	+0.00Hz	0A
COM. SCANNER INPUT			<input type="checkbox"/>
Scan. In1 address	:		3204
Scan. In2 address	:		3206
Scan. In3 address	:		0
Scan. In4 address	:		0
Scan. In5 address	:		0
Code		Quick	<input checked="" type="checkbox"/>
Scan. In6 address	:		0
Scan. In7 address	:		0
Scan. In8 address	:		0

RDY	NET	+0.00Hz	0A
COM. SCANNER OUTPUT			<input type="checkbox"/>
Scan. Out1 address	:		9001
Scan. Out2 address	:		9002
Scan. Out3 address	:		0
Scan. Out4 address	:		0
Scan. Out5 address	:		0
Code		Quick	<input checked="" type="checkbox"/>
Scan. Out6 address	:		0
Scan. Out7 address	:		0
Scan. Out8 address	:		0

Note:

All modifications to parameters [Scan. Out● address] (n L R ●) or [Scan. In● address] (n P R ●) must be made with the motor stopped. The master PLC program should be updated to take account of this modification.

8. Configuration of the assemblies

8. 5. Configuring the control

■ Principle

By the configuration of the control, it is possible to decide from what channel the drive receives its commands and setpoint, either permanently or depending on a switching command.

Numerous configurations are possible. For more information, refer to the Programming manual and Communication parameters manual. The following configurations are some of the possibilities available.

□ Control with communication scanner

If the default assemblies (100, 101) are selected, all possibilities of Altivar 71 drive are available.

It is possible to use all profiles and modes of the drive:

- I/O profile,
- Drivecom profiles with separate or non separate mode.

By the configuration of the communication scanner, it is possible to assign any relevant parameter of the drive to the 4 input and 4 output variables of the assemblies.

See the input / output interface with the PLC can be fully customised depending on the application.

The use of the communication scanner is also the best way to interface with a "Controller Inside" card.

□ Control according to ODVA AC drive profile

The ODVA AC drive profile is activated when one of the following assemblies is selected:

- 20: Basic speed control output
- 21: Extended speed control output
- 22: Speed and torque control output
- 23: Extended speed and torque control output
- 70: Basic speed control input
- 71: Extended speed control input
- 72: Speed and torque control input
- 73: Extended speed and torque control input

The advantage of using the ODVA drive profile standard is the interchangeability with other brands.

The drive must be configured in the Drivecom profile with separate mode.

The EtherNet/IP card translates the commands, behaviour and monitoring information from of ODVA profile (on the network) to the Drivecom profile (in the drive).

□ Control according to Allen-Bradley® drive profile

The Allen-Bradley® Drive profile is activated when one of the following assemblies is selected:

- 103: Allen-Bradley® drive output
- 104: Allen-Bradley® drive input

If you need to replace Allen-Bradley® drives, in an existing application, this profile is a good way to minimise the modifications.

The drive must be configured in the Drivecom profile with separate mode.

The EtherNet/IP card translates the commands, behaviour and monitoring information from of Allen-Bradley® drive profile (on the network) to the Drivecom profile (in the drive).

8. Configuration of the assemblies

■ Available configurations

□ If you use the communication scanner:

- 100: Communication scanner output
- 101: Communication scanner input there is no limitation in the configuration of the control.

The examples below are only possible if you use the communication scanner.

□ If you use the ODVA AC drive profile or Allen-Bradley® Drive profile, that is, the assemblies:

- 20: Basic speed control output
- 21: Extended speed control output
- 22: Speed and torque control output
- 23: Extended speed and torque control output
- 70: Basic speed control input
- 71: Extended speed control input
- 72: Speed and torque control input
- 73: Extended speed and torque control input
- 103: Allen-Bradley® drive output
- 104: Allen-Bradley® drive input

Parameter	Permitted value	Comment
Profile	Drivecom profile separate	The run commands are in Drivecom profile, the command and the reference can come from different channels.
Setpoint 1 configuration	Network card	Setpoint 1 comes from EtherNet/IP.
Setpoint 1B configuration	Terminals	Setpoint 2 comes from terminals (AI1 or AI2).
Setpoint 2 configuration	Terminals	Setpoint 2 comes from terminals (AI1 or AI2).
Command 1 configuration	Network card	Command 1 comes from EtherNet/IP.
Command 2 configuration	Terminals	Command 2 comes from terminals.
Command switching	Network card bit 12	Bit 12 of the control word switches the command.
Setpoint switching	Network card bit 13	Bit 13 of the control word switches the setpoint (1 <-> 1B or 1 <-> 2).

Configuration via the graphic display terminal or the integrated display terminal:

Case 1: Setpoint 1B is connected to the functions (Summing, PID, etc) which remain active even after switching.

Menu	Parameter	Permitted value
[1.6 - COMMAND] (C E L -)	[Profile] (C H C F)	[Separate] (S E P)
	[Ref.1 channel] (F r 1)	[Com. card] (n E E)
	[Ref.1B channel] (F r 1b)	[Ref. AI1] (A I 1) or [Ref. AI2] (A I 2)
	[Cmd channel 1] (C d 1)	[Com. card] (n E E)
	[Cmd channel 2] (C d 2)	[Terminals] (E E r)
	[Cmd switching] (C C 5)	[C312] (C 3 1 2)
[1.7 APPLICATION FUNCT.] (F U n -) [REFERENCE SWITCH.]	[Ref 1B switching] (r C b)	[C313] (C 3 1 3)

Case 2: Setpoint 2 is directly connected to the drive reference limit. If switching is performed, the functions that affect the reference (summing, PID, etc.) are inhibited.

Menu	Parameter	Permitted value
[1.6 - COMMAND] (C E L -) [1.7 APPLICATION FUNCT.] (F U n -) [REFERENCE SWITCH.]	[Profile] (C H C F)	[Separate] (S E P)
	[Ref.1 channel] (F r 1)	[Com. card] (n E E)
	[Ref.2 channel] (F r 2)	[Ref. AI1] (A I 1) or [Ref. AI2] (A I 2)
	[Cmd channel 1] (C d 1)	[Com. card] (n E E)
	[Cmd channel 2] (C d 2)	[Terminals] (E E r)
	[Cmd switching] (C C 5)	[C312] (C 3 1 2)
	[Ref. 2 switching] (r F C)	[C313] (C 3 1 3)

Note: It is not possible to configure the display terminal as a channel.

To switch to the display terminal, use the function force local and assign the parameter [Forced local Ref.] to [HMI] (L C C).

8. Configuration of the assemblies

■ Control via EtherNet/IP in I/O profile

Note: This configuration can only be used if the communication scanner assemblies (100 and 101) are selected.

The command and the setpoint come from EtherNet/IP.
Control is in I/O profile.

Configure the following parameters:

Parameter	Value	Comment
Profile	I/O profile	The run command is simply obtained by bit 0 of the command word.
Setpoint 1 configuration	Network card	The setpoint comes from EtherNet/IP.
Command 1 configuration	Network card	The command comes from EtherNet/IP.

Configuration via the graphic display terminal or the integrated display terminal:

Menu	Parameter	Value
[1.6 - COMMAND] (C E L -)	[Profile] (C H C F)	[I/O profile] (I 0)
	[Ref.1 channel] (F r 1)	[Com. card] (n E E)
	[Cmd channel 1] (C d 1)	[Com. opt card] (n E E)

■ Control via EtherNet/IP or via the terminals in I/O profile

Note: This configuration can only be used if the communication scanner assemblies (100 and 101) are selected.

The command and the setpoint both come from EtherNet/IP or the terminals. Input LI5 at the terminals is used to switch between EtherNet/IP and the terminals.
Control is in I/O profile.

Configure the following parameters:

Parameter	Value	Comment
Profile	I/O profile	The run command is simply obtained by bit 0 of the control word.
Setpoint 1 configuration	Network card	Setpoint 1 comes from EtherNet/IP.
Setpoint 1B configuration	Analog input 1 on the terminals	Setpoint 1B comes from input AI1 on the terminals.
Setpoint switching	Input LI5	Input LI5 switches the setpoint (1 ↔ 1B).
Command 1 configuration	Network card	Command 1 comes from EtherNet/IP.
Command 2 configuration	Terminals	Command 2 comes from the terminals.
Command switching	Input LI5	Input LI5 switches the command.

Note: Setpoint 1B is connected to the functions (Summing, PID, etc) which remain active even after switching.

Configuration via the graphic display terminal or the integrated display terminal:

Menu	Parameter	Value
[1.6 - COMMAND] (C E L -)	[Profile] (C H C F)	[I/O profile] (I 0)
	[Ref.1 chan] (F r 1)	[Com. card] (n E E)
	[Cmd channel 1] (C d 1)	[Com. card] (n E E)
	[Cmd channel 2] (C d 2)	[Terminals] (E E r)
	[Cmd switching] (C C S)	[LI5] (L I 5)
[1.7 APPLICATION FUNCT.] (F U n -) [REFERENCE SWITCH.]	[Ref.1B chan] (F r 1 b)	[AI1 ref.] (R I I)
	[Ref 1B switching] (r C b)	[LI5] (L I 5)

8. Configuration of the assemblies

■ Control via EtherNet/IP in Drivecom profile

Note: This configuration can only be used if the communication scanner assemblies (100 and 101) are selected.

The command and the setpoint come from EtherNet/IP.

Configure the following parameters:

Parameter	Value	Comment
Profile	Separate Drivecom profile	The run commands are in Drivecom profile, the command and the setpoint can come from different channels.
Setpoint 1 configuration	Network card	The setpoint comes from EtherNet/IP.
Command 1 configuration	Network card	Command 1 comes from EtherNet/IP.

Configuration via the graphic display terminal or the integrated display terminal:

Menu	Parameter	Value
[1.6 - COMMAND] (E L L -)	[Profile] (E H C F)	[Separate] (S E P)
	[Ref.1 chan] (F r 1)	[Com. card] (n E E)
	[Cmd channel 1] (E d 1)	[Com. card] (n E E)

■ Control via EtherNet/IP or the terminals in Drivecom profile

Note: This configuration can only be used if the communication scanner assemblies (100 and 101) are selected.

The command and the setpoint both come from EtherNet/IP or the terminals. Input LI5 at the terminals is used to switch between EtherNet/IP and the terminals.

Configure the following parameters:

Parameter	Value	Comment
Profile	Separate Drivecom profile	The run commands are in Drivecom profile, the command and the setpoint can come from different channels.
Setpoint 1 configuration	Network card	Setpoint 1 comes from EtherNet/IP.
Setpoint 2 configuration	Analog input 1 on the terminals	Setpoint 2 comes from input AI1 on the terminals.
Setpoint switching	Input LI5	Input LI5 switches the setpoint (1 ↔ 2) and the command.
Command 1 configuration	Network card	Command 1 comes from EtherNet/IP.
Command 2 configuration	Terminals	Command 2 comes from the terminals.
Command switching	Input LI5	Input LI5 switches the command.

Note: Setpoint 2 is directly connected to the drive reference limit. If switching is performed, the functions that affect the reference (summing, PID, etc) are inhibited.

Configuration via the graphic display terminal or the integrated display terminal:

Menu	Parameter	Value
[1.6 - COMMAND] (E L L -)	[Profile] (E H C F)	[Separate] (S E P)
	[Ref.1 chan] (F r 1)	[Com. card] (n E E)
	[Ref.2 chan] (F r 2)	[AI1 ref.] (A I 1)
	[Ref. 2 switching] (r F C)	[LI5] (L I 5)
	[Cmd channel 1] (E d 1)	[Com. card] (n E E)
	[Cmd channel 2] (E d 2)	[Terminals] (E E r)
	[Cmd switching] (E C S)	[LI5] (L I 5)

8. Configuration of the assemblies

■ Control in Drivecom profile via EtherNet/IP and setpoint switching at the terminals

Note: This configuration can only be used if the communication scanner assemblies (100 and 101) are selected.

The command comes from EtherNet/IP.

The setpoint comes either from EtherNet/IP or from the terminals. Input LI5 at the terminals is used to switch the setpoint between EtherNet/IP and the terminals.

Control is in Drivecom profile.

Configure the following parameters:

Parameter	Value	Comment
Profile	Separate Drivecom profile	The run commands are in Drivecom profile, the command and the setpoint can come from different channels.
Setpoint 1 configuration	Network card	Setpoint 1 comes from EtherNet/IP.
Setpoint 1B configuration	Analog input 1 on the terminals	Setpoint 1B comes from input AI1 on the terminals.
Setpoint switching	Input LI5	Input LI5 switches the setpoint (1 ↔ 1B).
Command 1 configuration	Network card	Command 1 comes from EtherNet/IP.
Command switching	Channel 1	Channel 1 is the command channel.

Note: Setpoint 1B is connected to the functions (summing, PID, etc) that remain active, even after switching.

Configuration via the graphic display terminal or the integrated display terminal:

Menu	Parameter	Value
[1.6 - COMMAND] (C L L -)	[Profile] (C H C F)	[Separate] (S E P)
	[Ref.1 chan] (F r 1)	[Com. card] (n E k)
	[Cmd channel 1] (C d 1)	[Com. card] (n E k)
	[Cmd switching] (C C 5)	[ch1 active] (C d 1)
[1.7 APPLICATION FUNCT.] (F U n -) [REFERENCE SWITCH.]	[Ref.1B chan] (F r 1 b)	[AI1 ref.] (R 1 1)
	[Ref 1B switching] (r C b)	[LI5] (L I 5)

9. Fault management

9. 1. Fault management

An EtherNet/IP time out is triggered if the card does not receive any cyclic messages (regardless within a predefined time period). This period is managed by the EtherNet/IP controller (not by the drive) and is configured in its module properties box. The duration of the time out is defined by the RPI (Request packet intervals).

If the card is controlled by explicit messages(without periodic exchanges) There is no control of the communication time-out.

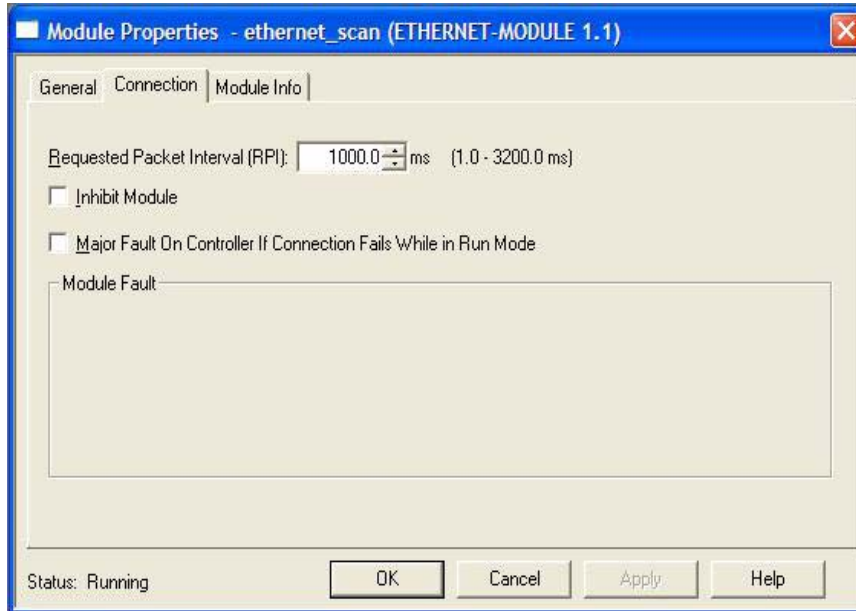

The **response** of the drive in case of such event can be configured.

Configuration can be performed using the graphic display terminal or integrated display terminal using the **[Network fault mgt] (ELL)** parameter in the **[1.8 FAULT MANAGEMENT] (FLE-)** menu, **[COM. FAULT MANAGEMENT] (ELL-)** submenu.

RDY	NET	+0.00Hz	0A
COM. FAULT MANAGEMENT <input type="checkbox"/>			
Network fault mgt	:		Freewheel
CANopen fault mgt	:		Freewheel
Modbus fault mgt	:		Freewheel
	:		
	:		
	:		
Code		Quick	<input checked="" type="checkbox"/>

The values of the **[Network fault mgt] (ELL)** parameter, trigger a **[COM. network] (ENF)** drive fault, are:

Value	Meaning
[Freewheel] (YES)	Freewheel stop (factory setting)
[Ramp stop] (RPP)	Stop on ramp
[Fast stop] (FSE)	Fast stop
[DC injection] (DEI)	DC injection stop

The values of the **[Network fault mgt] (ELL)** parameter, which do not trigger a drive fault, are:

Value	Meaning
[Ignore] (ND)	Fault ignored
[Per STT] (SET)	Stop according to configuration of [Type of stop] (SET)
[Fallback spd] (LFF)	Switch to fallback speed, maintained as long as the fault is present and the run command is not disabled.
[Spd maint.] (RLS)	The drive maintains the speed at the time the fault occurred, as the fault persists and the run command has not been removed.

The fallback speed can be configured via the **[Fallback spd] (LFF)** parameter in the **[1.8 FAULT MANAGEMENT] (FLE-)** menu.

9. Fault management

9. 2. Status of the LEDs

The VW3 A3 316 Ethernet/IP card features 5 LEDs, which are visible through the Altivar 61/71 cover.

1.1	
1.2	
1.3	
1.4	
1.5	
2.1	Port 1 activity
2.2	Port 2 activity
2.3	Link status
2.4	NS "Network status"
2.5	MS "Module status"

The 2 first LEDs are respectively dedicated to each Ethernet port.
 The third LED is relative to the IP level.
 The 2 last LEDs are specific to EtherNet/IP and CIP communication protocol.

LED	Color/ state	Description
2.1	Off	No link
	Flashing Green/yellow	Power up testing.
	Green ON	Link at 100 Mbps.
	Yellow ON	Link at 10 Mbps.
	Green BLINK	Activity at 100 Mbps.
	Yellow BLINK	Activity at 10 Mbps.
2.2	Off	No link
	Flashing Green/yellow	Power up testing.
	Green ON	Link at 100 Mbps.
	Yellow ON	Link at 10 Mbps.
	Green BLINK	Activity at 100 Mbps.
	Yellow BLINK	Activity at 10 Mbps.
2.3	Off	Physical connections unplugged - No IP address obtained
	Flashing Green/red	Power up testing.
	Green ON	At least one port is connected and an IP address has been obtained.
	Green flashing 3 times	All ports are unplugged, but the card has an IP address.
	Green flashing 4 times	Error: Duplicated IP address (1)
	Green flashing 5 times	The card is performing a BOOTP or DHCP sequence
2.4 "NS"	Off	The device does not have an IP address or powered off.
	Flashing Green/red	Power up testing.
	Green ON	The device has at least one established connection (even to the Message Router).
	Green flashing	The device has not established connections, but has obtained an IP address.
	Red flashing	One or more of the connections in which this device is the target has timed out. This shall be left only if all time out connections are reestablished or if the device is reset.
	Red ON	The device has detected that its IP address is already in use (1).
2.5 "MS"	Off	No power is supplied to the device
	Flashing Green/red	Power Up testing.
	Green ON	The device is operating correctly.
	Green flashing	The device has not been configured.
	Red flashing	The device has detected a recoverable minor fault.
	Red ON	The device has detected a non-recoverable major fault (1).

(1) In case of duplicate IP Address, the led 2.3 is green flashing 4 times, led 2.4 and 2.5 are solid red.

10. Configuration of monitored parameters

It is possible to select up to 4 parameters to display their values in the [1.2 - MONITORING] menu on the graphic display terminal.

The selection is made via the [6 - MONITORING CONFIG.] menu, [6.3 - COM. MAP CONFIG.] submenu.

Each parameter in the range [Address 1 select.] ... [Address 4 select.] is used to select the parameter logic address. Select an address of zero to disable the function.

In the example given here, the monitored words are:

- Parameter 1 = Motor current (LCR): logic address 3204; signed decimal format.
- Parameter 2 = Motor torque (OTR): logic address 3205; signed decimal format.
- Parameter 3 = Last fault occurred (LFT): logic address 7121; hexadecimal format.
- Disabled parameter: address 0; default format: hexadecimal format.

RDY	NET	+0.00Hz	0A
6.3 COM. MAP CONFIG.			<input type="checkbox"/>
Word 1 add. select.	:		3204
Format word 1	:		Signed
Word 2 add. select.	:		3205
Format word 2	:		Signed
Word 3 add. select.	:		7121
Code		Quick	<input checked="" type="checkbox"/>
Format word 33	:		Hex
Word 4 add. select.	:		0
Format word 4	:		Hex

One of the three display formats below can be assigned to each monitored word:

Format	Range	Terminal display
Hexadecimal	0000 ... FFFF	[Hex]
Signed decimal	-32,767 ... 32,767	[Signed]
Unsigned decimal	0 ... 65,535	[Unsigned]

11. Webserver

This chapter describes the function of the integrated webserver of the EtherNet/IP card.

11. 1. Opening the Altivar home page

From your web browser, default http password and login are : USER, USER for monitor and setup security level and ADMIN, ADMIN for administrator level.



From the altivar home page, you can access to 4 main menus:

- Drive,
- Network setup,
- Network diagnostic,
- Email

11. 2. Web pages structure

Each web page uses the same structure. Each main menu, "Drive", "Network setup" and "Network Diagnostics" contains each own sub menu. This last one is displayed on the left side of web page.



The  toggle button shows or hides the left sided menu.

11. Webserver

11. 3. Drive

■ Drive monitor

Drive monitor

Device Reference: **ATV71H075M3**

Device Name: **Not defined**

Altivar State: **RDY**

FBH Freq. Ref.	Hz	0.0
RFR Output Freq.	Hz	0.0
OTR Output Torque	%	0.0
ULN Mains Voltage	V	218.7
UOP Motor voltage	V	0.0
LCR Motor Current	A	0.0
THD Drive Thermal	%	44.0
THR1 Motor Thermal	%	0.0
OPR Output Power	%	0.0
APH Power Used	kWh	0.0
RTH Run Time	h	0.0

L17	AI1	0.0040	R1
L12	AI2	0.01	R2
L13	AI3	0.0	R3
L14	AI4	0.0	R4
L15	AO1	0.0	LO1
L16	AO2	0.0	LO2
L13	AO3	0.0	LO3
L14	AO3	0.0	LO4

Motor Speed (RPM)

Motor speed gauge showing 0 RPM.

© 2009 Schneider Electric. All Rights Reserved.

11. Webserver

■ Drive parameters

The screenshot shows the Schneider Electric Altivar 71-61 webserver interface. The top navigation bar includes 'Home' and 'Documentation'. The main menu has 'Drive', 'Network setup', 'Network diagnostic', and 'Email'. The left sidebar contains 'Drive', 'Drive monitor', 'Drive parameters' (selected), and 'Drive recorder'. The main content area displays the 'Drive parameters' page with a table of parameters and a status bar at the bottom.

Parameter Group	Address	UnitId	Description	Value	Unit
Control parameters					
Setpoint parameters	7391	0	Date	0	
Status parameters	7392	0	Time	0	
Actual values parameters	3207	0	Mains voltage	218.8	V
Reference parameters	3230	0	Energy consumption	0	Wh
Measurement parameters	3209	0	Drive thermal state	44	%
I/O parameters	9630	0	Motor thermal state	0	%
Fault parameters	14114	0	Resistor thermal state	0	%
Log parameters	3231	0	Total motor operating time	0	s
Identification parameters	3232	0	Internal motor operating time	0	s
Communication parameters	3233	0	Total drive operating time	6	s
Controller Inside parameter	3235	0	IGBT alarm time	0	s
D5402 configuration parameter	12209	0	Current bobbin time	0	min

Started, number of requests = 8 | 125ms | 93ms | 125ms

© 2009 Schneider Electric. All Rights Reserved.

The left column is used to select a mod/imd group (or list) of parameters. The right columns displays the parameters, its Modbus address and its current value.

■ SAVING PARAMETERS

When parameters of the drive are modified from the webserver, they are not saved into drive memory (to avoid numerous write access to the flash memory).

However, it is possible to perform the backup of the parameters from the webserver: This operation can be done by writing 2 to CMI parameter. This operation saves ALL the parameters of the drive to flash memory.

11. Webserver

■ Drive recorder

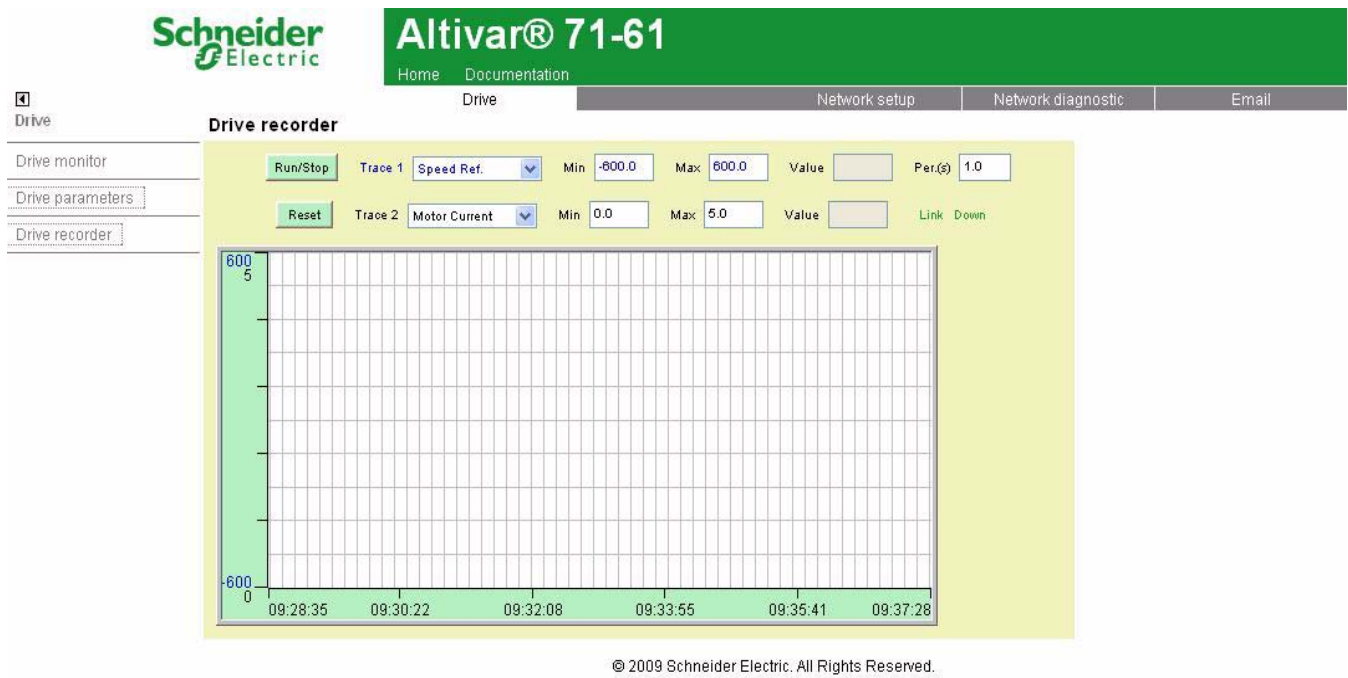

The trend viewer shows traces of two preselected parameters

RUN/STOP: Starts or stoppes the trends recording.

Reset : Erases the recorded trend.

Min/Max : defines the lowest and highest values that are displayed on the trend window.

Per(s) : Periodicity : Minimal value.

11. Webserver

11. 4. Network setup

The screenshot shows the Schneider Electric Altivar® 71-61 webserver interface. At the top, there is a green header with the Schneider Electric logo and the product name 'Altivar® 71-61'. Below the header, there is a navigation bar with links for 'Home', 'Documentation', 'Drive', 'Network setup', 'Network diagnostic', and 'Email'. The 'Network setup' link is highlighted. In the center, there is an image of the Altivar 71 drive unit. Below the image, it says 'Web site version : 1.0.0.2' and '© 2009 Schneider Electric. All Rights Reserved.'. On the left side, there is a sidebar menu with the following items: 'Network setup', 'EtherNet/IP setup', 'EtherNet/IP scanner', 'Monitor security', 'Setup security', and 'Administrator security'. A blue circle highlights the 'Network setup' item in the sidebar. On the right side, there is a larger menu titled 'Network setup' with the following items: 'EtherNet/IP setup', 'EtherNet/IP scanner', 'Monitor security', 'Setup security', and 'Administrator security'. A blue arrow points from the 'Network setup' item in the sidebar to the 'Network setup' menu on the right.

■ Monitor security

The screenshot shows the Schneider Electric Altivar® 71-61 webserver interface. At the top, there is a green header with the Schneider Electric logo and the product name 'Altivar® 71-61'. Below the header, there is a navigation bar with links for 'Home', 'Documentation', 'Drive', 'Network setup', 'Network diagnostic', and 'Email'. The 'Network setup' link is highlighted. In the center, there is a form titled 'Monitor security'. The form has two sections. The first section is for changing the password and has the following fields: 'Monitor login:', 'New password:', 'Confirm password:', and a 'Change password' button. The second section is for changing the monitor login and has the following fields: 'Monitor login:', 'New monitor login:', 'Confirm monitor login:', and a 'Change monitor login' button. On the left side, there is a sidebar menu with the following items: 'Network setup', 'EtherNet/IP setup', 'EtherNet/IP scanner', 'Monitor security', 'Setup security', and 'Administrator security'. The 'Monitor security' item is highlighted. Below the form, it says '© 2009 Schneider Electric. All Rights Reserved.'.

The Monitor security password is the basic level access to the drive through the webserver: it allows the access to the different web pages but don't authorize write access.
New level username and password can be redefined here.

11. Webserver

■ Setup security

The screenshot shows the Schneider Electric Altivar® 71-61 web interface. The top navigation bar includes 'Home', 'Documentation', 'Drive', 'Network setup', 'Network diagnostic', and 'Email'. The left sidebar contains a menu with 'Setup security' highlighted. The main content area is titled 'Setup security' and contains three input fields: 'Setup password:', 'New setup password:', and 'Confirm setup password:'. A 'Change setup password' button is located below the fields. The footer text reads '© 2009 Schneider Electric. All Rights Reserved.'

- HTTP : data write.
- Data write level password.

■ Administrator security

The screenshot shows the Schneider Electric Altivar® 71-61 web interface. The top navigation bar includes 'Home', 'Documentation', 'Drive', 'Network setup', 'Network diagnostic', and 'Email'. The left sidebar contains a menu with 'Administrator security' highlighted. The main content area is titled 'Administrator security' and contains two sections. The first section has a 'Login:' field set to 'Administrator', a 'Password:' field, a 'New password:' field, a 'Confirm password:' field, and a 'Change adm password' button. The second section has a 'Login:' field set to 'Administrator', a 'Password:' field, and a 'Reset all user right' button. The footer text reads '© 2009 Schneider Electric. All Rights Reserved.'

11. Webserver

■ EtherNet/IP setup

Network setup
 EtherNet/IP setup
 EtherNet/IP scanner
 Monitor security
 Setup security
 Administrator security

EtherNet/IP setup
Network setting
 Rate & duplex mode: Autodetect
 IP mode: Manual
 IP address: 192.168.1.12
 Subnet mask: 255.255.255.0
 Gateway address: 192.168.1.1
 Device Name:
 Password:

© 2009 Schneider Electric. All Rights Reserved.

■ EtherNet/IP scanner setup

Network setup
 EtherNet/IP setup
 EtherNet/IP scanner
 Monitor security
 Setup security
 Administrator security

EtherNet/IP scanner setup
Drive input parameters

Parameter	Config.	Description
<input checked="" type="checkbox"/> CW	-	Control word
VP	-	Velocity point
<input checked="" type="checkbox"/> NCA1	CMD	Cmd value
NCA2	LFRD	LFRD
<input checked="" type="checkbox"/> NCA3	-0-	Not Assigned
NCA4	ACC	Acceleration
<input checked="" type="checkbox"/> NCA5	-0-	Not Assigned
NCA6	-0-	Not Assigned
<input checked="" type="checkbox"/> NCA7	-0-	Not Assigned
NCA8	-0-	Not Assigned

Drive output parameters

Parameter	Config.	Description
<input checked="" type="checkbox"/> SW	-	Status word
VF	-	Velocity feedback
<input checked="" type="checkbox"/> NMA1	ETA	ETA state word
NMA2	RFRD	RFRD
<input checked="" type="checkbox"/> NMA3	-0-	Not Assigned
NMA4	-0-	Not Assigned
<input checked="" type="checkbox"/> NMA5	-0-	Not Assigned
NMA6	-0-	Not Assigned
<input checked="" type="checkbox"/> NMA7	-0-	Not Assigned
NMA8	-0-	Not Assigned

Save Abort
 Setpoint unit: Rpm

© 2009 Schneider Electric. All Rights Reserved.

11. Webserver

■ Email management

The screenshot shows the Schneider Electric Altivar 71-61 web interface. The top navigation bar includes 'Home', 'Documentation', 'Drive', 'Network setup', 'Network diagnostic', and 'Email'. The left sidebar has 'Email' selected. The main content area is titled 'Email management' and is divided into two sections: 'Configuration' and 'Monitoring'.

Configuration

Send an email message when:

- A fault occurs
- A warning is reported
- A Controller Inside event occurs
- A communication fault occurs

Email IP server @

Email dest. @

Email from @

Monitoring

Ethernet IP @

Device name

Email status

Last email Error

Send counter

Error counter

© 2009 Schneider Electric. All Rights Reserved.

Configuration of the email generator on the left side:

- email IP server Address
- email sender address, recipient address from 0.

11. 5. Diagnostics

The screenshot shows the Schneider Electric Altivar 71-61 web interface. The top navigation bar includes 'Home', 'Documentation', 'Drive', 'Network setup', 'Network diagnostic', and 'Email'. The left sidebar has 'Network diagnostics' selected. The main content area shows a photograph of the Altivar 71-61 drive unit. Below the photograph, it says 'Web site version : 1.0.0.2' and '© 2009 Schneider Electric. All Rights Reserved.'.

Network diagnostics

Ethernet statistics

Message statistics

11. Webserver

■ Ethernet statistics

Schneider Electric **Altivar® 71-61**

Home Documentation Drive Network setup Network diagnostic Email

Network diagnostics **Ethernet statistics**

Ethernet statistics Message statistics

Device Type	ALTIVAR 71	Data rate	100 Mbit/s	IP address	10.0.0.1
Device reference	ATV71H075M3	Duplex mode	Full Duplex	Subnet mask	255.255.255.0
Software revision	1.0ie01			Gateway address	0.0.0.0
MAC Address	00-80-f4-7d-00-03			IP mode	Manual
				Device name	Not defined

Transmit		Receive		Other errors	
Transmit counter	57818	Receive counter	67668	Collisions	0
Transmit errors	0	Receive errors	0	Multi Collisions	0
Deferred Emissions	0	CRC errors	0	Over Run	0
Late collisions	0	Frame errors	0		
Buffer Errors	0	Buffer Errors	0		

Reset counters

© 2009 Schneider Electric. All Rights Reserved.

■ Message statistics

Schneider Electric **Altivar® 71-61**

Home Documentation Drive Network setup Network diagnostic Email

Network diagnostics **Message statistics**

Ethernet statistics Message statistics

TCP/UDP	
Open sockets	5
CIP open connections	0
Modbus open connections	1

CIP			
Assemblies		I/O messaging	Explicit messaging
	Instance	Size	Transmit counter
Input	0	0	0
Output	0	0	0
			Receive counter
			0
			Error counter
			0
			UCMM request
			0
			UCMM error
			0
			Class3 request
			0
			Class3 error
			0

Modbus TCP	
Transmit counter	2582
Receive counter	2593
Error counter	0

Reset counters

© 2009 Schneider Electric. All Rights Reserved.

NOTE: As a Schneider product, The EtherNet/IP option card uses internally MODBUS TCP for the web-server. (The MODBUS TCP port is not accessible).

12. Integration in RSLogix

12.1. Principle

RSX drive equipped with an EtherNet/IP card shall be configured as a "Generic Ethernet Module" in the same way as the EtherNet/IP adapter of PowerFlex 70 drives.

12.2. Procedure

■ Create a new project

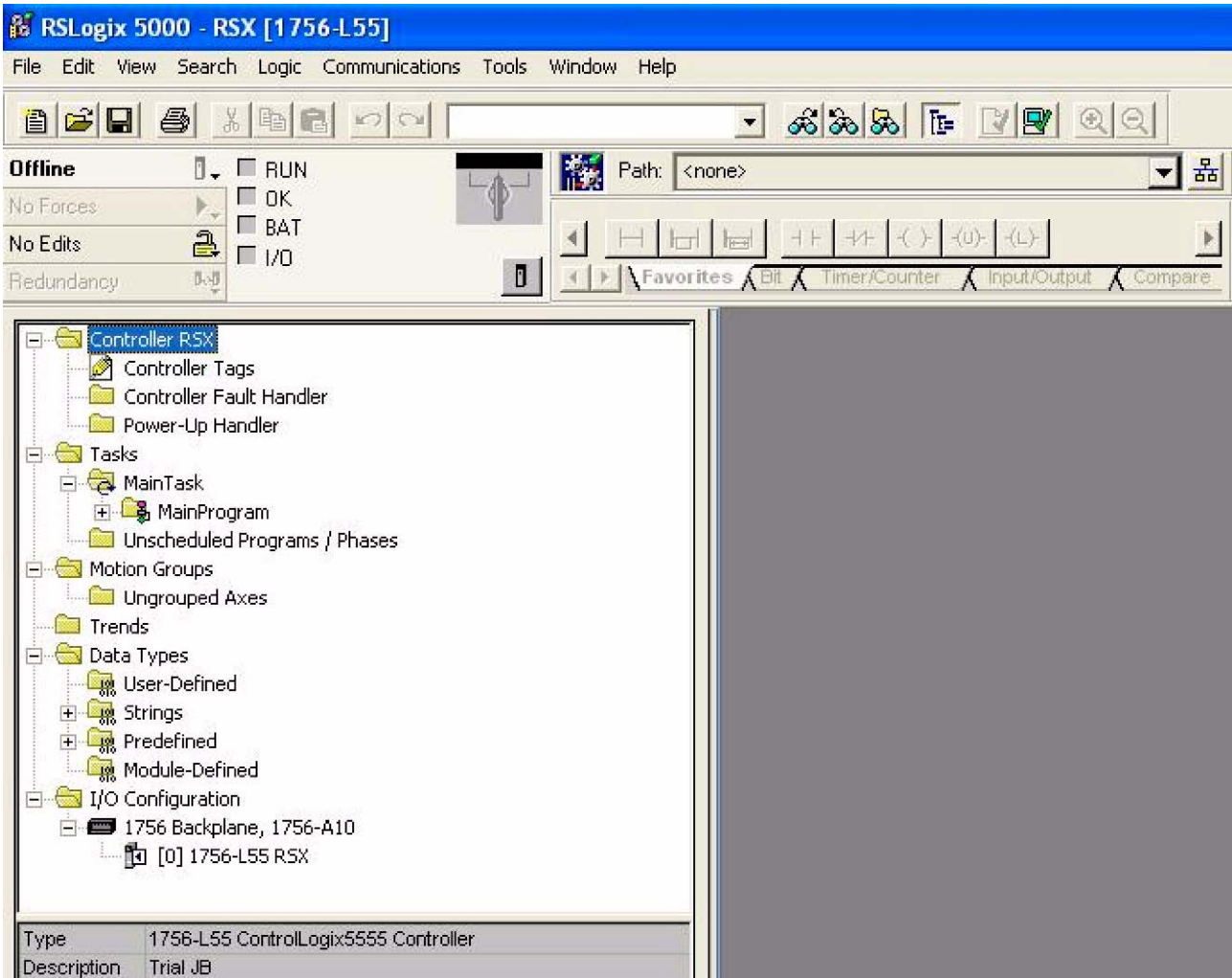

12. Integration in RSLogix

■ Add a EtherNet/IP scanner to the I/O configuration

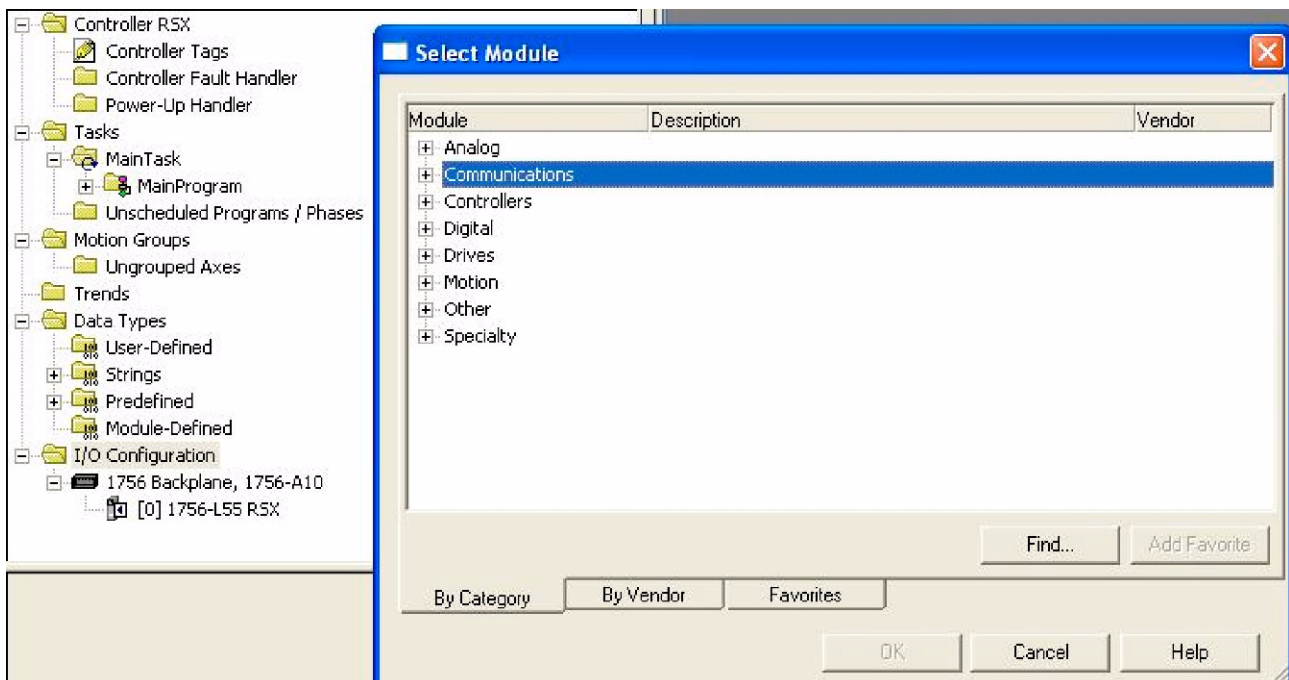
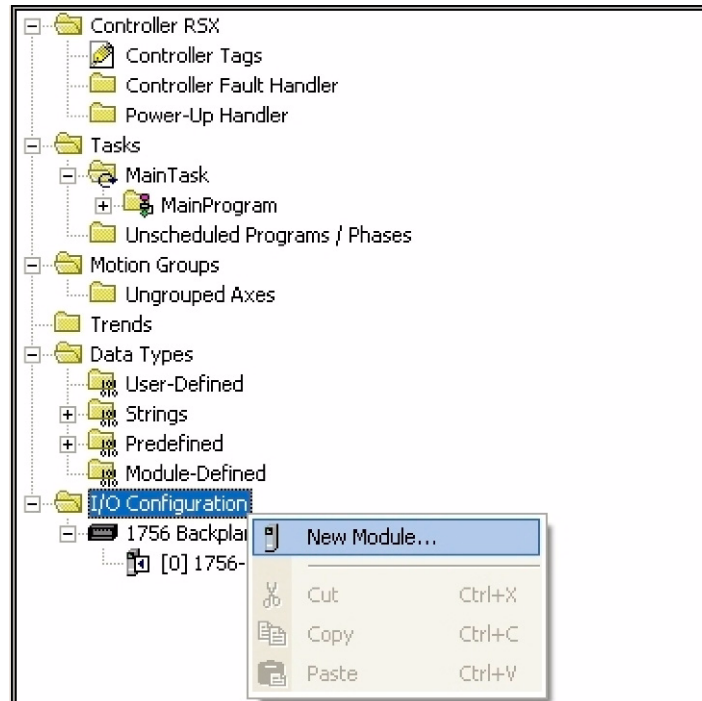

12. Integration in RSLogix

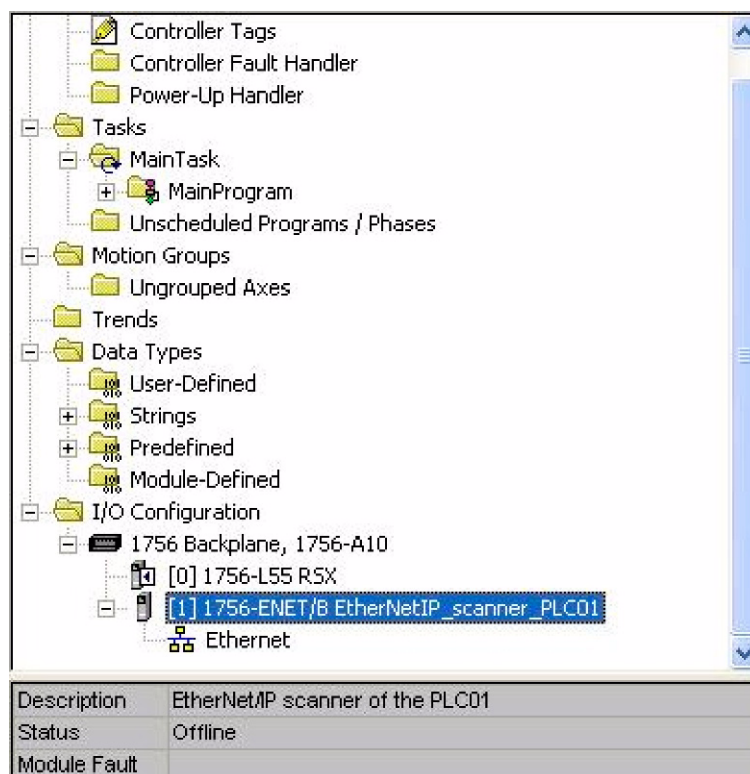
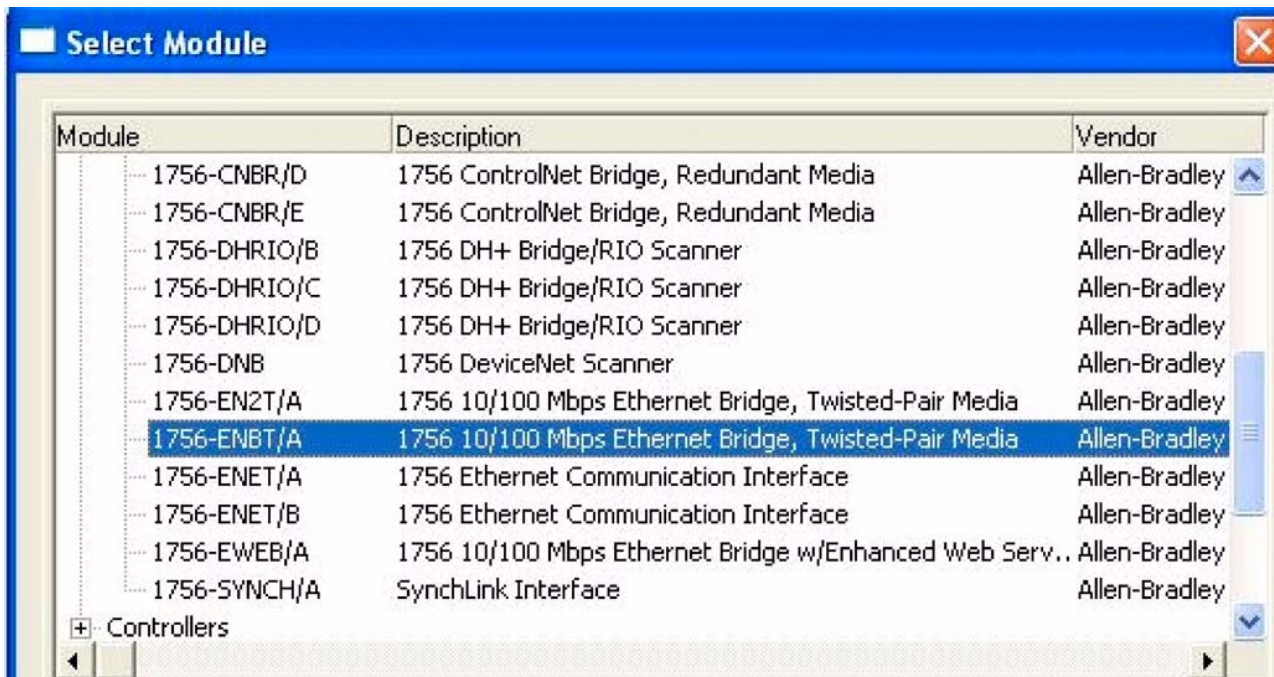

12. Integration in RSLogix

■ Configure the EtherNet/IP scanner

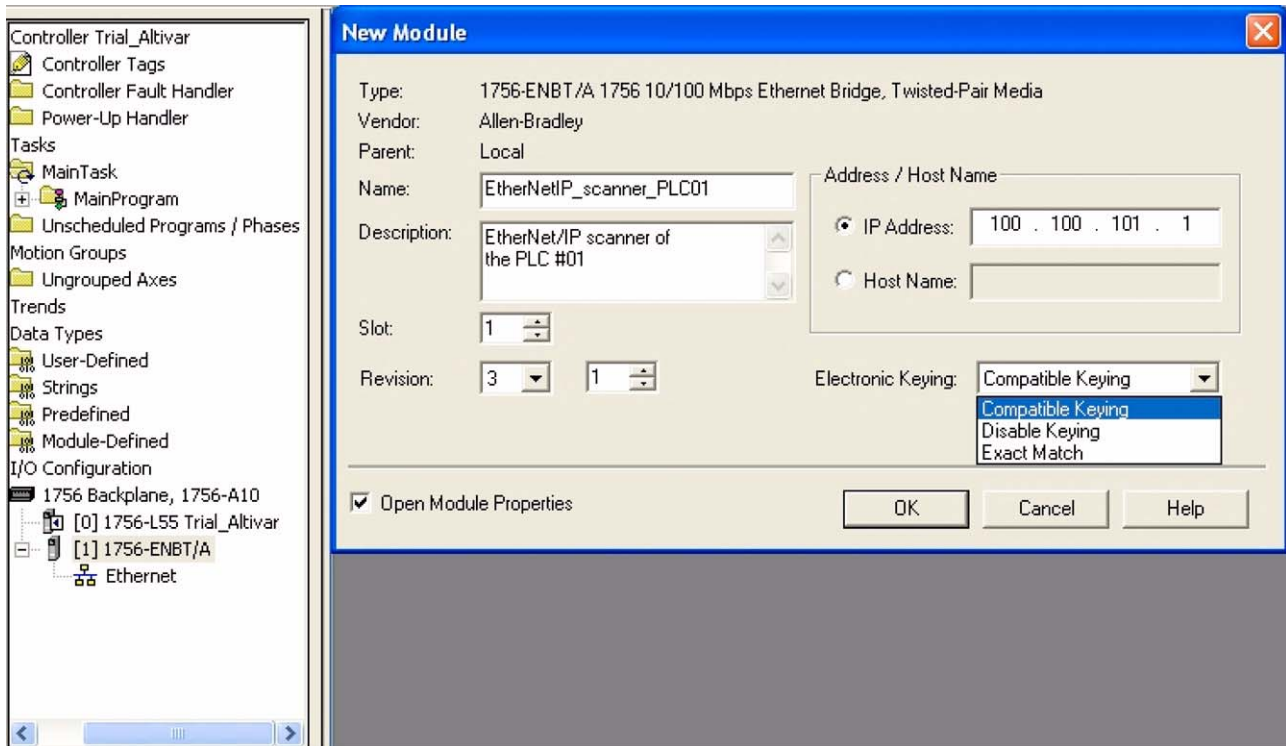

■ Add a EtherNet/IP ATV71/61 drive to the I/O configuration

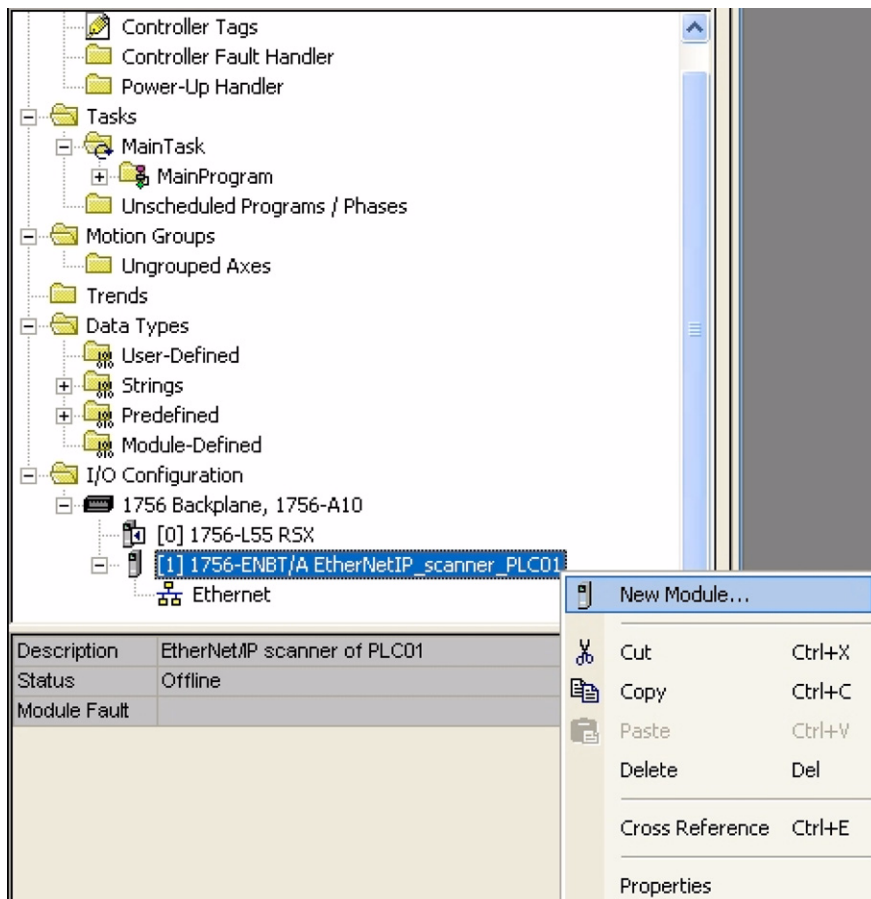

12. Integration in RSLogix

The screenshot shows the RSLogix software interface. On the left, a project tree is visible with the following structure:

- Ungrouped Axes
- Trends
- Data Types
 - User-Defined
 - Strings
 - Predefined
 - Module-Defined
- I/O Configuration
 - 1756 Backplane, 1756-A10
 - [0] 1756-L55 RSX
 - [1] 1756-ENBT/A EtherNetIP_scanner_PLC01
 - Ethernet

Below the tree, a table displays the selected module's details:

Description	EtherNetIP scanner of PLC01
Status	Offline
Module Fault	

On the right, the 'Select Module' dialog box is open. It features a table with the following columns: Module, Description, and Vendor. The 'Communications' category is expanded, showing 'Drives' and 'HMI' sub-categories.

The screenshot shows the RSLogix software interface. On the left, a project tree is visible with the following structure:

- Controller Tags
- Controller Fault Handler
- Power-Up Handler
- Tasks
 - MainTask
 - MainProgram
 - Unscheduled Programs / Phases
 - Motion Groups
 - Ungrouped Axes
 - Trends
 - Data Types
 - User-Defined
 - Strings
 - Predefined
 - Module-Defined
 - I/O Configuration
 - 1756 Backplane, 1756-A10
 - [0] 1756-L55 RSX
 - [1] 1756-ENBT/A EtherNetIP_scanner_PLC01
 - Ethernet

Below the tree, a table displays the selected module's details:

Description	EtherNetIP scanner of PLC01
Status	Offline
Module Fault	

On the right, the 'Select Module' dialog box is open. It features a table with the following columns: Module, Description, and Vendor. The 'ETHERNET-MODULE' is selected. The table lists various Ethernet modules and their descriptions.

Module	Description	Vendor
1769-L32E Etherne..	10/100 Mbps Ethernet Port on CompactLogix5332E	Allen-Bradley
1769-L35E Etherne..	10/100 Mbps Ethernet Port on CompactLogix5335E	Allen-Bradley
1788-EN2DN/A	1788 Ethernet to DeviceNet Linking Device	Allen-Bradley
1788-ENBT/A	1788 10/100 Mbps Ethernet Bridge, Twisted-Pair Media	Allen-Bradley
1788-EWEB/A	1788 10/100 Mbps Ethernet Bridge w/Enhanced Web Serv..	Allen-Bradley
1794-AENT/A	1794 10/100 Mbps Ethernet Adapter, Twisted-Pair Media	Allen-Bradley
Drivelogix5730 Eth...	10/100 Mbps Ethernet Port on DriveLogix5730	Allen-Bradley
ETHERNET-BRIDGE	Generic EtherNet/IP CIP Bridge	Allen-Bradley
ETHERNET-MODULE	Generic Ethernet Module	Allen-Bradley
EtherNet/IP	SoftLogix5800 EtherNet/IP	Allen-Bradley
PH-P55CENA/A	Ethernet Adapter, Twisted-Pair Media	Parker Hannif

The dialog box also includes a search bar, 'Find...' and 'Add Favorite' buttons, and sorting options: 'By Category', 'By Vendor', and 'Favorites'. At the bottom, there are 'OK', 'Cancel', and 'Help' buttons.

12. Integration in RSLogix

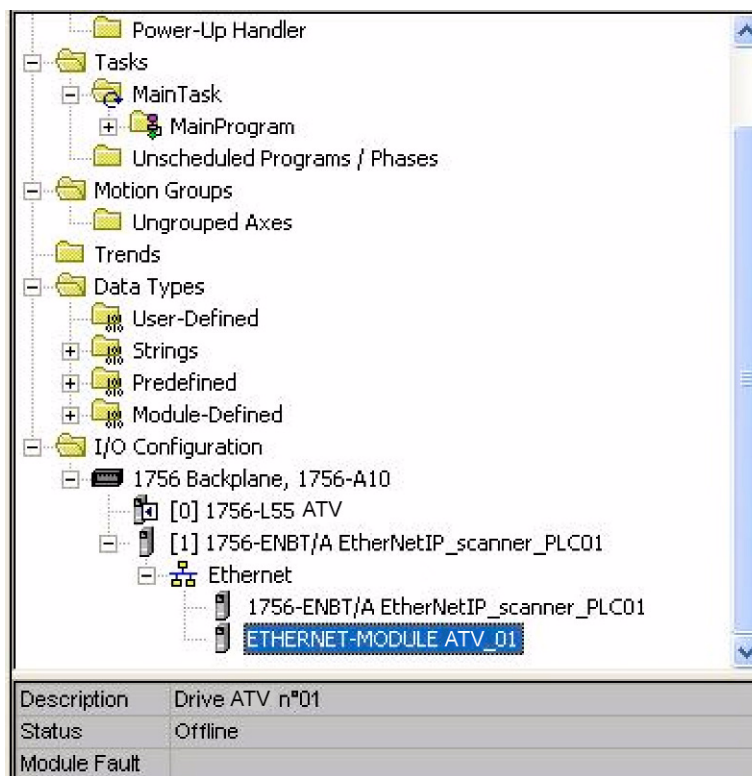

■ Configure the ATV71 EtherNet/IP card

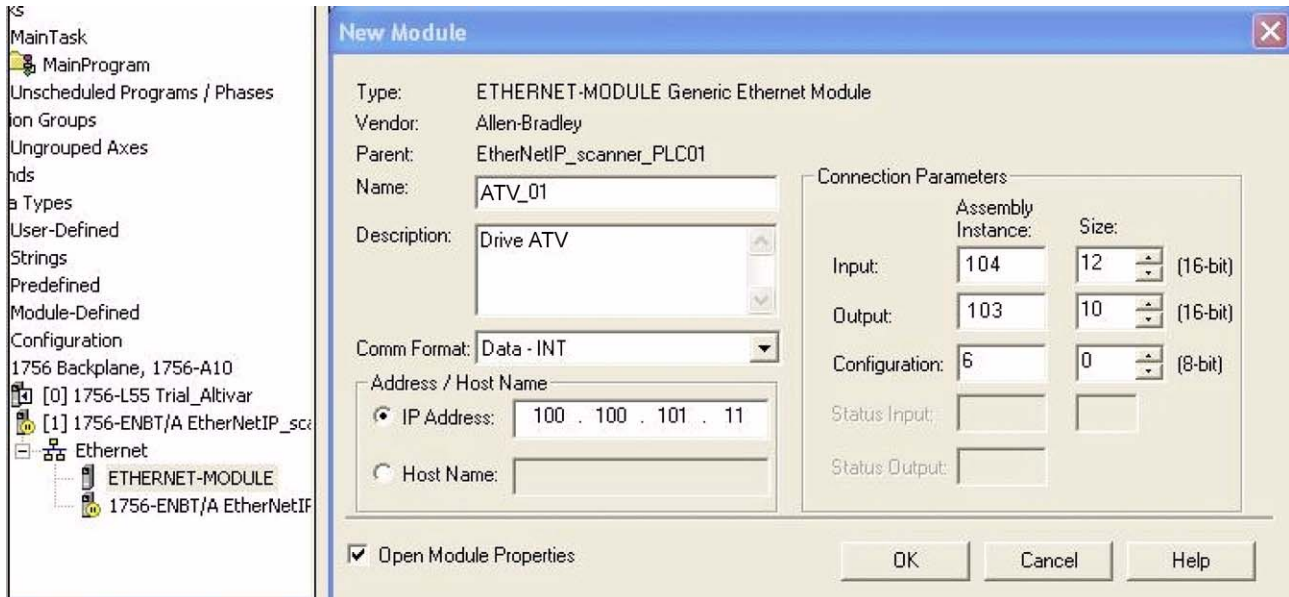

Above the Allen-Bradley drive profile is selected.

12. Integration in RSLogix

Below the CIP extended speed control profile is selected.

New Module

Type: ETHERNET-MODULE Generic Ethernet Module
Vendor: Allen-Bradley
Parent: EtherNetIP_scanner_PLC01
Name: ATV_01
Description: Drive ATV
Comm Format: Data - INT
Address / Host Name
 IP Address: 100 . 100 . 101 . 11
 Host Name:
 Open Module Properties

Connection Parameters

	Assembly Instance:	Size:	
Input:	71	2	(16-bit)
Output:	21	2	(16-bit)
Configuration:	6	0	(8-bit)
Status Input:			
Status Output:			

OK Cancel Help

Below the CIP extended speed and torque control profile is selected.

Module Properties: EtherNetIP_scanner_PLC01 (ETHERNET-MODULE 1.1)

General | Connection | Module Info

Type: ETHERNET-MODULE Generic Ethernet Module
Vendor: Allen-Bradley
Parent: EtherNetIP_scanner_PLC01
Name: ATV_01
Description: Drive ATV
Comm Format: Data - INT
Address / Host Name
 IP Address: 100 . 100 . 101 . 11
 Host Name:
Status: Offline

Connection Parameters

	Assembly Instance:	Size:	
Input:	73	3	(16-bit)
Output:	23	3	(16-bit)
Configuration:	6	0	(8-bit)
Status Input:			
Status Output:			

OK Cancel Apply Help

12. Integration in RSLogix

Below native RSX profile is selected.

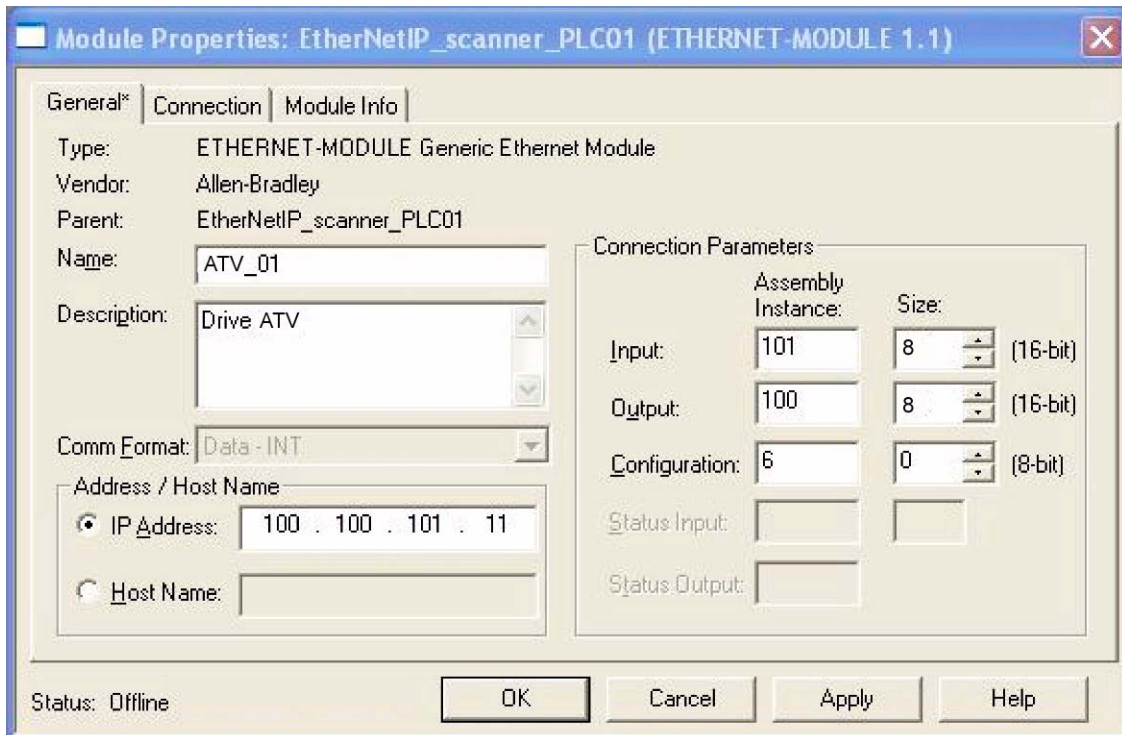

12. 3. Registering the EDS file in RSlogix

An EDS file is provided with the drive. (This file is available on the CD or on www.schneider-electric.com). It exists 1 EDS file for the ATV71 and 1 EDS file for the ATV61. The following lines describe how to import these files in your project:

In RSnetWorx , start the EDS wizards

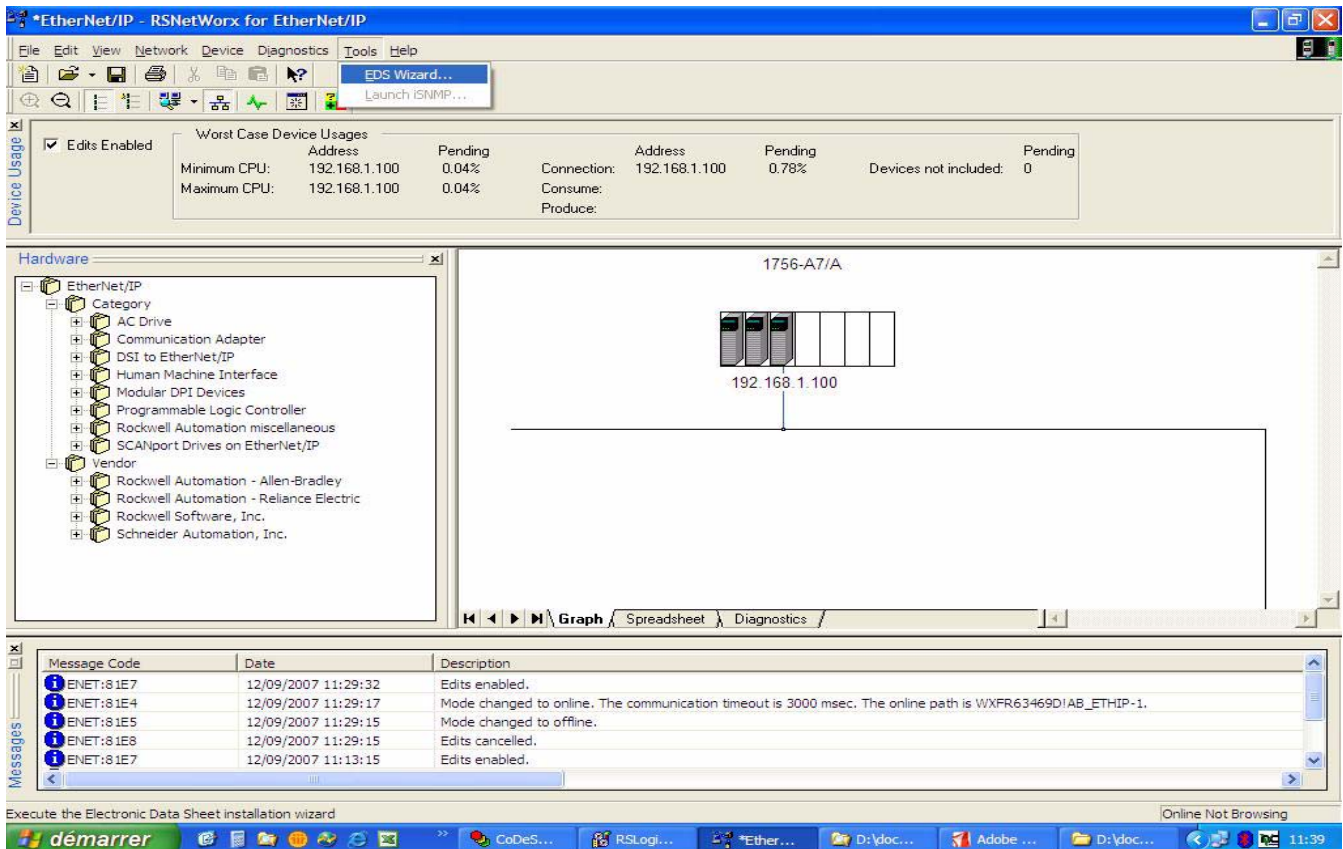

12. Integration in RSLogix

Follow the instructions:



Choose "Register" to import a new EDS file.
If you want to update an EDS file you need to "unregister" this device first.



12. Integration in RSLogix

Select the required file:

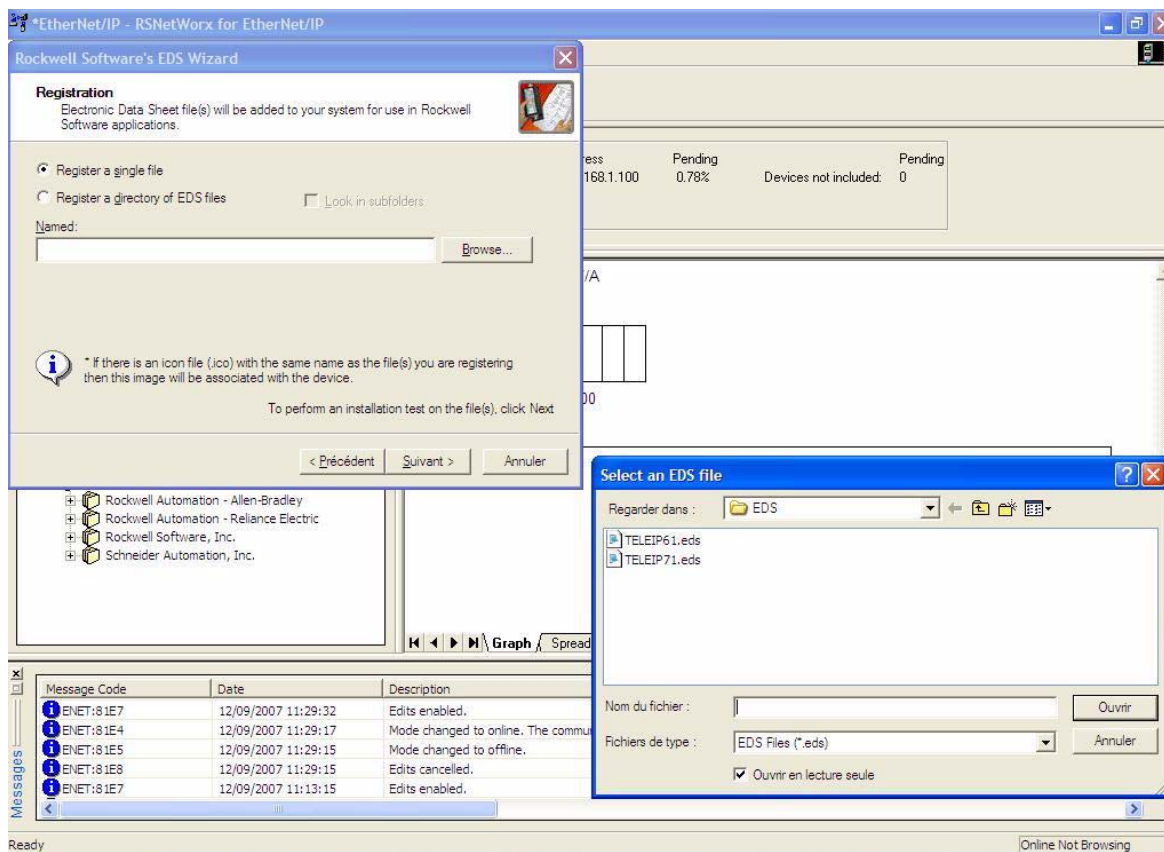

Then finish, the dialog box displays the result of the import operation.

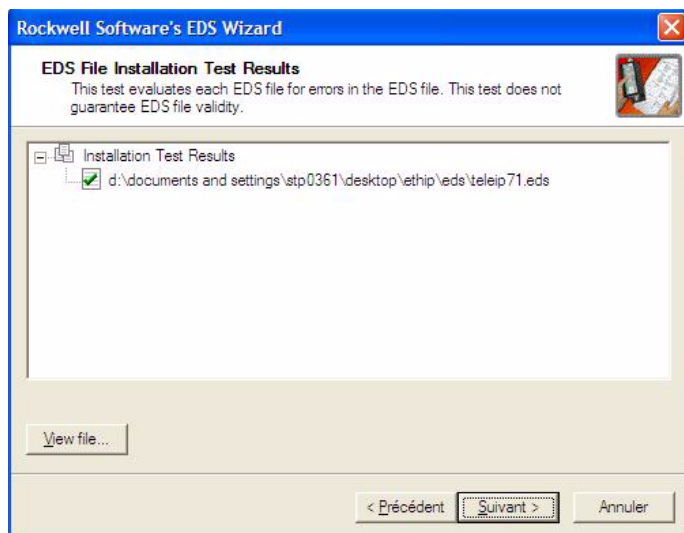

13. CIP objects

13. 1. Supported object classes

Three categories of object classes can be defined:

- 1: CIP device on EtherNet/IP.
- 2: AC/DC drive.
- 3: VSD specific.

These objects are detailed here:

Object class	Class ID	Cat.	Number of instances	Effect on behavior Interface
Identity object (13. 2.) page 44	16#01	1	1	Supports the reset service
Message router object (13. 3.) page 45	16#02	1	1	Explicit message connection
Ethernet Link object (13. 4.) page 47	16#F6	1	1	Counter and status information
TCP/IP Interface object (13. 5.) page 50	16#F5	1	1	TCP/IP configuration
Connection object manager (13. 6.) page 52	16#05	1	1	
Motor data object (13. 7.) page 53	16#28	2	1	Defines data for the motor connected to the device
Control supervisor object (13. 8.) page 54	16#29	2	1	Manages drive functions, operational states and control
AC/DC Drive Object (13. 9.) page 56	16#2A	2	1	Provides drive configuration
Assembly object (13. 10.) page 57	16#04	2	12	Defines I/O data format
Application objects (13. 11.) page 58		3	1	Vendor specific - drive's parameters

13. 2. Identity object

The Identity object provides identification and status information about the drive.

Class code

Hexadecimal	Decimal
16#01	1

Class attributes

Attribute ID	Access	Name	Need	Data type	Value	Details
1	Get	Revision	Opt.	UINT	1	—
2	Get	Max Instances	Opt.	UINT	1	1 defined instance

13. CIP objects

Instance attributes

Attribute ID	Access	Name	Need	Data type	Value	Details
1	Get	Vendor ID	Req.	UINT	243	Schneider Automation, Inc [243]
2	Get	Device type	Req.	UINT	16#02	AC/DC drive profile
3	Get	Product code	Req.	UINT	5 or 7	5: ATV71 7: ATV61
4	Get	Revision	Req.	Struct of: USINT USINT	—	Product revision of the drive (1)
5	Get	Status	Req.	WORD	—	See definition in the table below
6	Get	Serial number	Req.	UDINT	—	Serial number of the drive
7	Get	Product name	Req.	Struct of: USINT STRING	—	11 (product name length) "ATV71 Drive"
8	Get	State	Opt.	USINT	—	0: Non existent 1: Device self-testing 2: Standby 3: Operational 4: Major recoverable fault 5: Major unrecoverable fault
10	Get/Set	Heartbeat interval (2)	Opt.	USINT	0–255	Interval in seconds between two heartbeat messages. 0: No message.

(1) Mapped in a word: MSB minor revision (second USINT), LSB major revision (first USINT).
Example: 517 = 16#0205 means revision V5.2.

(2) The heartbeat message broadcasts the current state of the device.

13. 3. Message router object

The Message router object is the element through which all the "Explicit messages" objects pass in order to be directed towards the objects they are truly destined to.

Class code

Hexadecimal	Decimal
16#02	2

Class attributes

Attribute ID	Access	Name	Need	Data type	Value	Details
1	Get	Revision	Opt.	UINT	1	-
2	Get	Max instances	Opt.	UNT	1	1 Defined instance

13. CIP objects

Instance attributes

Attribute ID	Access	Name	Need	Data type	Value	Details
1	Get	Object list: Number classes	Opt.	Struct of: UINT UINT []	20 (codes)	List of supported objects; the first UINT is the number of supported classes; the remaining UINTs are the codes of these classes.
2	Get	Number available	Opt.	UINT	1	Maximum number of simultaneous connections
3	Get	Number active	Opt.	UINT	1	Number of active connections
4	Get	Active connections	Opt.	UINT []	1	List of active connections (referred to with their respective Connection instance ID)

Class service

Service code	Service name	Need	Description
16#0E	Get_Attribute_Single	Req.	Read an attribute

Instance service

Service code	Service name	Need	Description
16#0E	Get_Attribute_Single	Req.	Read an attribute

13. CIP objects

13. 4. Ethernet Link object

This object provides the mechanism to configure a device's TCP/IP network interface.

■ Class code

Hexadecimal	decimal
16#F5	245

■ Class attributes

Class attributes for this object are optional.

■ Instance attributes

Attribute ID	Access	Name	need	Data type	Value	Details	
1	Get	Status	Req.	DWORD	Bit level	0	The interface configuration attribute has not been configured.
						1	The interface configuration contains a valid configuration.
						2-15	Reserved for future use.
2	Get	Configuration capability	Req.	DWORD	Bit level	0	BOOTP Client.
						1	DNS Client.
						2	DHCP Client.
						3	DHCP-DNS capable.
						4	Interface configuration settable.
						All other bits are reserved and shall be set to 0.	
3	Get Set	Configuration control	Req.	DWORD	Bit level	0	The interface configuration is valid.
						1	The interface configuration must be obtained with BOOTP.
						2	The interface configuration must be obtained with DHCP..
						3	Reserved.
						4	DNS Enable.
All other bits are reserved and shall be set to 0.							
NOTE : This attribute interacts with the Altivar 71 parameter [IPmode]. (see chapter 8.).							
4	Get	Physical link	Req.	STRUCT { UINT path size Padded EPATH path }		Path size: number of 16 bit words in the element Path Path: Logical segments identifying the physical link object. The path is restricted to one logical class segment and one logical instance segment. The maximum size is 12 bytes.	

13. CIP objects

Attribute ID	Access	Name	need	Data type	Value	Details
5	Get Set	Interface configuration	Req.	STRUCT { UDINT IP Address UDINT Network Mask UDINT Gateway address UDINT Primary Name server UDINT Secondary name server STRING Default Domain name }		<p>IP Address: Value of 0 indicates no IP address has been configured. Otherwise, the IP address shall be set to a valid Class A, B, or C address and shall not be set to the loopback address (127.0.0.1).</p> <p>Network Mask: Value of 0 indicates no network mask address has been configured.</p> <p>Gateway Address: Value of 0 indicates no IP address has been configured. Otherwise, the IP address shall be set to a valid Class A, B, or C address and shall not be set to the loopback address (127.0.0.1).</p> <p>Primary name: Value of 0 indicates no name server address has been configured. Otherwise, the name server address shall be set to a valid Class A, B, or C address.</p> <p>Secondary Name: Value of 0 indicates no secondary name server address has been configured. Otherwise, the name server address shall be set to a valid Class A, B, or C address.</p> <p>Default domain name: ASCII characters. Maximum length is 48 characters. Shall be padded to an even number of characters (pad not included in length). A length of 0 shall indicate no Domain Name is configured.</p>
6	Get Set	Host Name	Req.	STRING		ASCII characters. Maximum length is 64 characters. Shall be padded to an even number of characters (pad not included in length). A length of 0 shall indicate no Host Name is configured.

■ Class service

Service Code	Service Name	Need	Description
16#01	Get_Attribute_All	Optional	Returns a predefined listing of this objects attributes.
16#0E	Get_Attribute_Single	Optional	Returns the contents of the specified attribute.

■ Instance service

Service Code	Service Name	Need	Description
16#01	Get_Attribute_All	Optional	Returns a predefined listing of this objects attributes.
16#0E	Get_Attribute_Single	Required	Returns the contents of the specified attribute.
16#02	Set_Attribute_All	optional	Modifies all settable attributes.
16#10	Set_Attribute_Single	Required	Modifies a single attribute.

13. CIP objects

■ Behaviour

The following state machine is used to configure the TCP/IP network interface.

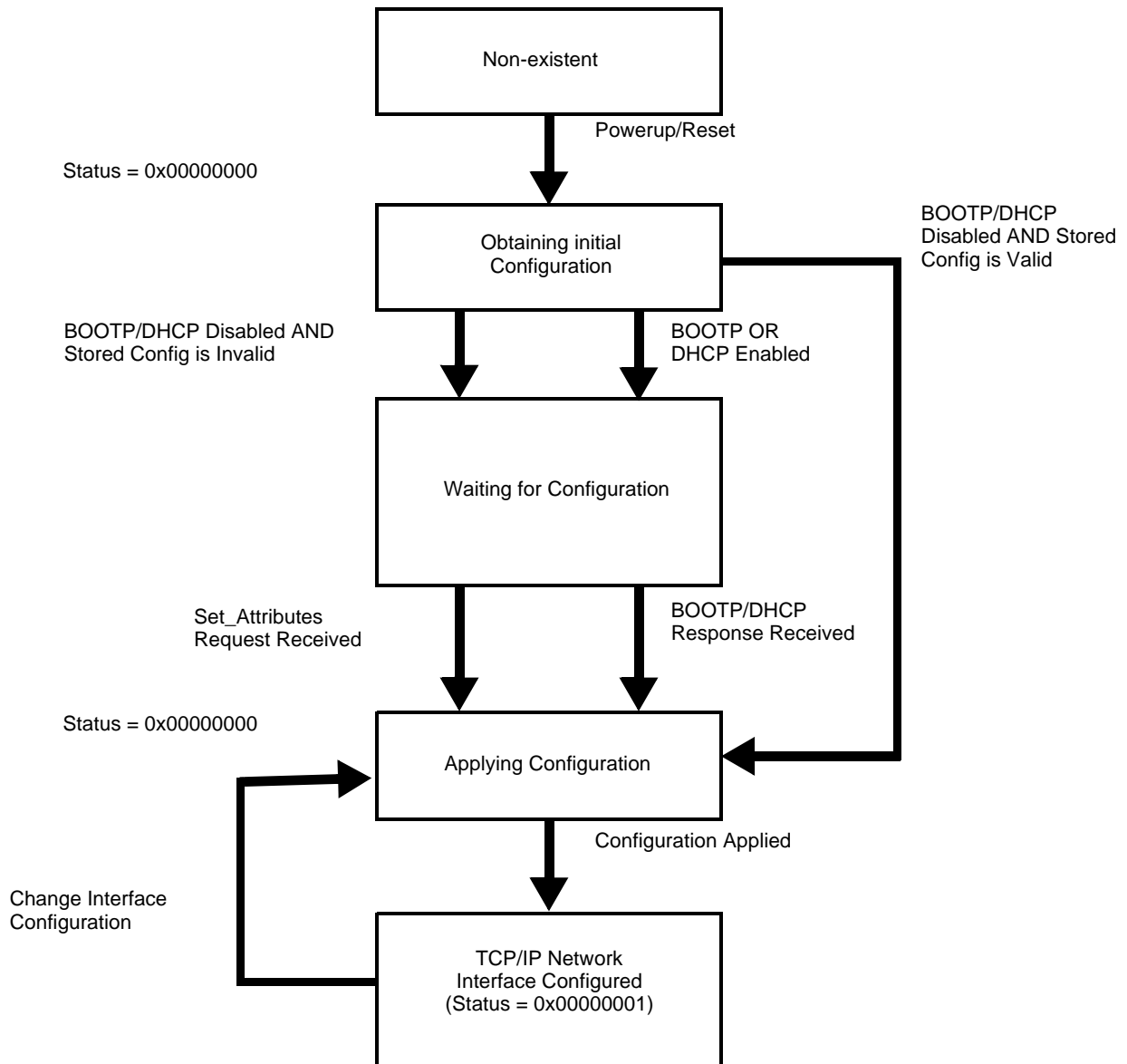

13. CIP objects

13. 5. TCP/IP Interface object

This object maintains link specific counters and status information for an Ethernet 802.3 communications interface.

■ Class code

Hexadecimal	Decimal
16#F6	246

■ Class attributes

Attribute ID	Access	Name	Need	Data type	Value
1	Get	Revision	Req.	UINT	2
2 through 7			optional		

■ Instance attributes ../

Attribute ID	Access	Name	Need	Data type	Value	Details										
1	Get	Interface Speed	Req.	UDINT	0,10,100 1000, etc.	Speed in Mbps.										
2	Get	Interface flags	Req.	DWORD	Bit level	<table border="1"> <tr> <td>0</td> <td>Link status</td> </tr> <tr> <td>1</td> <td>Half/full duplex</td> </tr> <tr> <td>2-4</td> <td>Negotiation status</td> </tr> <tr> <td>5</td> <td>Manual setting / requires reset</td> </tr> <tr> <td>6</td> <td>Local Hardware fault</td> </tr> </table> <p>All other bits are reserved and shall be set to 0.</p>	0	Link status	1	Half/full duplex	2-4	Negotiation status	5	Manual setting / requires reset	6	Local Hardware fault
0	Link status															
1	Half/full duplex															
2-4	Negotiation status															
5	Manual setting / requires reset															
6	Local Hardware fault															
3	Get	Physical Address	Req.	ARRAY OF 6 USINTs		This array contains the MAC address of the card.Format: XX-XX-XX-XX-XX-XX										
4 ...	Get	Interface counters	Cond.	STRUCT {												
				<i>UDINT In Octets</i>		<i>Octets received on the interface</i>										
				<i>UDINT In Ucast Packets</i>		<i>Unicast Packets received on the interface.</i>										
				<i>UDINT In NUCast Packets</i>		<i>Non Unicast Packets received on the interface.</i>										
				<i>UDINT In Discards</i>		<i>Inbound packets received on the interface but discarded.</i>										
				<i>UDINT In Errors</i>		<i>Inbound packets that contain errors. (does not include in Discards)</i>										
				<i>UDINT In Unknown Protos</i>		<i>Inbound packets with unknown protocol.</i>										
				<i>UDINT Out Octets</i>		<i>Octets sent on the interface.</i>										
				<i>UDINT Out Ucast packest</i>		<i>Unicast Packets sent on the interface.</i>										
				<i>UDINT Out NUCast Packets</i>		<i>Non Unicast Packets sent on the interface.</i>										
				<i>UDINT Out discards</i>		<i>Outbound packets discarded</i>										
				<i>UDINT</i>		<i>Outbound packets that contain errors</i>										
				}												

13. CIP objects

Attribute ID	Access	Name	Need	Data type	Value	Details
5	Get	Media Counters	Cond.	STRUCT {		
				UDINT Alignment errors		Frames received that are not an integral number of octets in length
				UDINT FCS Errors		Frames received that do not pass the FCS check
				UDINT Single collisions		Successfully transmitted frames which experienced exactly one collision
				UDINT Multiple Collisions		Successfully transmitted frames which experienced more than one collision
				UDINT SQE Test Errors		Number of times SQE test error message is generated
				UDINT Deferred Transmissions		Frames for which first transmission attempt is delayed because the medium is busy
				UDINT Late Collisions		Number of times a collision is detected later than 512 bittimes into the transmission of a packet
				UDINT Excessive Collisions		Frames for which transmission fails due to excessive collision
				UDINT MAC Transmit errors		Frames for which transmission fails due to an internal MAC sublayer transmit error
				UDINT Carrier sense Errors		Times that the carrier sense condition was lost or never asserted when attempting to transmit a frame
				UDINT Frame too long		Frames received that exceed the maximum permitted frame size
				UDINT MAC Receive Errors		Frames for which reception on an interface fails due to an internal MAC sublayer receive error
		}				
6	Set	Interface control	Optional	STRUCT {		
				WORD Control Bits		Interface control bits
				UINT Force interface Speed		Speed at which the interface shall be forced to operate.
				}		

13. CIP objects

■ Class service

Service Code	Service Name	Need	Description
16#01	Get_Attribute_All	Optional	Returns a predefined listing of this objects attributes.
16#0E	Get_Attribute_Single	Optional	Returns the contents of the specified attribute.
16#10	Get_and_clear	Cond.	Modifies a single attribute

■ Instance service

Service Code	Service Name	Need	Description
16#01	Get_Attribute_All	Optional	Returns a predefined listing of this objects attributes.
16#0E	Get_Attribute_Single	Required	Returns the contents of the specified attribute.
16#10	Set_Attribute_Single	Required	Modifies a single attribute.

13. 6. Connection object manager

Class code

Hexadecimal	Decimal
16#05	5

Class attributes

Attribute ID	Access	Name	Need	Data type	Value	Details
1	Get	Revision	Opt.	UINT	1	—
2	Get	Max instances	Opt.	UINT	4	3 defined instances (1)

(1) Only instances 1 (explicit message), 2 (polled I/O message), and 4 (change of state/cyclic message) are supported. Instance 3 (bit strobe) is not supported.

Attributes of instance 1—Explicit message instance

Attribute ID	Access	Name	Need	Data type	Value	Details
1	Get	State	Req.	USINT	—	0 : Non-existent 3 : Established 5 : Deferred Delete
2	Get	Instance_type	Req.	USINT	0	Explicit Message
3	Get	TransportClass_trigger	Req.	BYTE	16#83	Class 3 server
4	Get	Produced_connection_id	Req.	UINT	10xxxxxx011	xxxxxx = Node address
5	Get	Consumed_connection_id	Req.	UINT	10xxxxxx100	xxxxxx = Node address
6	Get	Initial_comm_characteristics	Req.	BYTE	16#21	Explicit messaging via Group 2
7	Get	Produced_connection_size	Req.	UINT	36	Produced data maximum size (in bytes)
8	Get	Consumed_connection_size	Req.	UINT	36	Consumed data maximum size (in bytes)
9	Get/Set	Expected_packet_rate	Req.	UINT	2500	2.5 sec. (TimeOut)
12	Get/Set	Watchdog_timeout_action	Req.	USINT	1 or 3	1 : Auto-Delete 3 : Deferred Delete (Default)
13	Get	Produced connection path length	Req.	UINT	0	Length of attribute 14 data
14	Get	Produced connection path	Req.	Array of UINT	Null	Empty
15	Get	Consumed connection path length	Req.	UINT	0	Length of attribute 16 data
16	Get	Consumed connection path	Req.	Array of UINT	Null	Empty

Refer to EtherNet/IP specification for more information.

13. CIP objects

13. 7. Motor data object

The Motor data object acts as a motor parameter database.

Class code

Hexadecimal	Decimal
16#28	40

Object 28hex (Motor Data)

Path	CIP name	CIP configuration parameter name
16#28/01/06 = 40/1/6	RatedCurrent	Motor Rated Cur
16#28/01/07 = 40/1/7	RatedVoltage	Motor Rated Volt
16#28/01/09 = 40/1/9	RatedFreq	Motor Rated Freq
16#28/01/0F = 40/1/15	BaseSpeed	Motor Base Speed

Telemecanique adaptation:

Path	Code	Altivar name	Logic address
16#28/01/06 = 40/1/6	NCR	Rated mot. current	16#2583 = 9603
16#28/01/07 = 40/1/7	UNS	Rated motor volt.	16#2581 = 9601
16#28/01/09 = 40/1/9	FRS	Rated motor freq.	16#2582 = 9602
16#28/01/0F = 40/1/15	NSP	Rated motor speed	16#2584 = 9604

Class attributes

Attribute ID	Access	Name	Need	Data type	Value	Details
1	Get	Revision	Opt.	UINT	2	—
2	Get	Max instance	Opt.	UINT	1	—
6	Get	Max ID number of class attribute	Opt.	UINT	7	—
7	Get	Max ID number of instance attribute	Opt.	UINT	15	—

Instance attributes

Attribute ID	Access	Name	Need	Data type	Value	Details
3	Get/Set	MotorType	Req.	USINT	7	6 = Wound rotor induction motor 7 = Squirrel cage induction motor
6	Get/Set	RatedCurrent	Req.	UINT	Depends on the drive rating	[Rated mot. current] (<i>n C r</i>)
7	Get/Set	RatedVoltage	Req.	UINT	Depends on the drive rating	[Rated mot. volt.] (<i>U n S</i>)
9	Get/Set	RatedFreq	Opt.	UINT	50/60	[Rated motor freq.] (<i>F r S</i>)
15	Get/Set	BaseSpeed	Opt.	UINT	Depends on the drive rating	[Nom motor speed] (<i>n S P</i>)

Class service

Service code	Service name	Need	Description
16#0E	Get_Attribute_Single	Req.	Read an attribute

Instance service

Service code	Service name	Need	Description
16#0E	Get_Attribute_Single	Req.	Read an attribute
16#10	Set_Attribute_Single	Opt.	Write an attribute

13. CIP objects

13. 8. Control supervisor object

The Control supervisor object models the functions for managing all devices within the hierarchy of motor control devices.

Object 29hex (Control Supervisor)

Path	CIP name	CIP configuration parameter name
16#29/01/0D = 41/1/13	FaultCode	Fault Code

Telemecanique adaptation:

Path	Code	Altivar name	Logic address
16#29/01/0D = 41/1/13	ERRD	CiA402 fault code	16#219E = 8606

Class code

Hexadecimal	Decimal
16#29	41

Class attributes

Attribute ID	Access	Name	Need	Data type	Value	Details
1	Get	Revision	Opt.	UINT	2	—
2	Get	Max instance	Opt.	UINT	1	—
6	Get	Max ID number of class attribute	Opt.	UINT	7	—
7	Get	Max ID number of instance attribute	Opt.	UINT	17	—

Instance attributes

Attribute ID	Access	Name	Need	Data type	Details
3	Get/Set	Run Fwd	Req.	BOOL	On an edge (0 →1)
4	Get/Set	Run Rev	Opt.	BOOL	On an edge (0 →1)
5	Get/Set	NetCtrl	Opt.	BOOL	0: Local Control (Channel 1) 1: Network Control (default)
6	Get	State	Opt.	USINT	0 = Vendor Specific, 1 = Startup, 2 = Not_Ready, 3 = Ready, 4 = Enabled, 5 = Stopping, 6 = Fault_Stop, 7 = Faulted
7	Get	Running Fwd	Req.	BOOL	
8	Get	Running Rev	Opt.	BOOL	
9	Get	Ready	Opt.	BOOL	
10	Get	Faulted	Req.	BOOL	
12	Get/Set	FaultRst	Req.	BOOL	Fault reset (0 →1)
13	Get	FaultCode	Opt.	UINT	Refer to the Communication parameters manual: DSP402 fault code (Errd)
15	Get	CtrlFromNet	Opt.	BOOL	0 = Local Control; 1 = Network Control

13. CIP objects

Class service

Service Code	Service name	Need	Description
16#0E	Get_Attribute_Single	Req.	Read an attribute

Instance service

Service Code	Service name	Need	Description
16#0E	Get_Attribute_Single	Req.	Read an attribute
16#10	Set_Attribute_Single	Req.	Write an attribute
16#05	Reset	Req.	Drive reset

Control supervisor state transition diagram

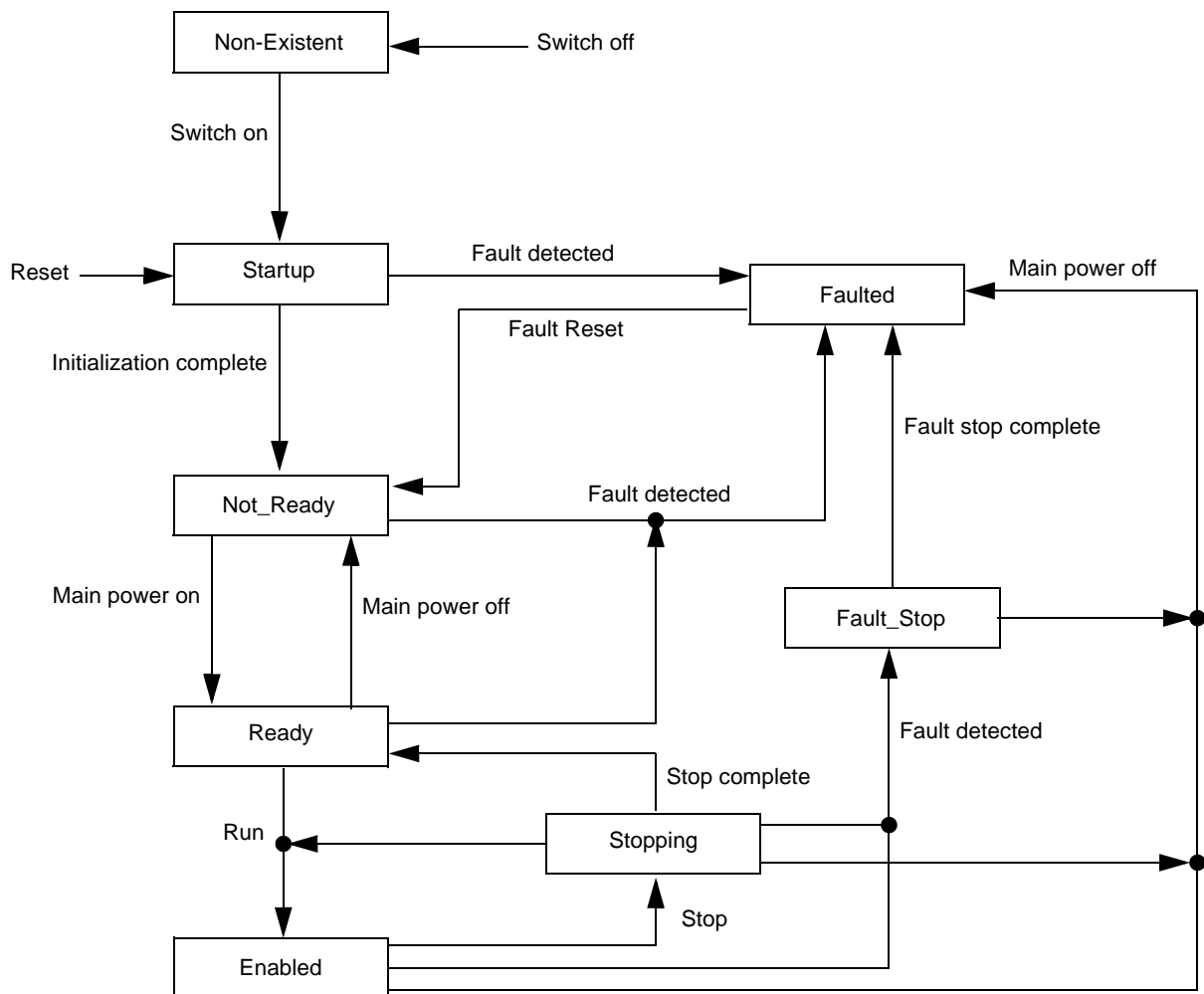

13. CIP objects

13.9. AC/DC Drive Object

The AC/DC Drive object models the functions (such as torque control and speed ramp) that are specific to drives.

Class code

Hexadecimal	Decimal
16#2A	42

Class attributes

Attribute ID	Access	Name	Need	Data Type	Value	Details
1	Get	Revision	Opt.	UINT	1	—
2	Get	Max instance	Opt.	UINT	1	—
6	Get	Max ID number of class attribute	Opt.	UINT	7	—
7	Get	Max ID number of instance attribute	Opt.	UINT	21	—

Instance attributes

Attribute ID	Access	Name	Need	Data type	Details
3	Get	AtReference	Opt.	BOOL	
4	Get/Set	NetRef (1)	Req.	BOOL	0: Local speed setpoint (AI1 or AI2) 1: Speed setpoint via the network
5	Get/Set	NetProc	Opt.	BOOL	Not handled
6	Get/Set	Drive mode	Req.	USINT	1: Open loop 2: Closed loop (FVC)
7	Get	SpeedActual	Req.	INT	Output speed (rFrd)
8	Get/Set	SpeedRef	Req.	INT	Speed setpoint (LFrd)
9	Get	CurrentActual	Opt.	INT	Motor current (LCr)
10	Get/Set	CurrentLimit	Opt.	INT	[Mot. therm. current] (ItH)
11	Get	TorqueActual	Opt.	INT	Output torque (Otrn)
12	Get/Set	TorqueRef	Opt.	INT	Torque setpoint (LtCr)
18	Get/Set	AccelTime	Opt.	UINT	Acceleration time (ACCd)
19	Get/Set	DecelTime	Opt.	UINT	Deceleration time (dECd)
20	Get/Set	LowSpdLimit	Opt.	UINT	Parameter [Low speed] (LSP) converted in RPM
21	Get/Set	HighSpdLimit	Opt.	UINT	Parameter [High speed] (HSP) converted in RPM

Class service

Service code	Service name	Need	Description
16#0E	Get_Attribute_Single	Req.	Read an attribute

Instance service

Service code	Service name	Need	Description
16#0E	Get_Attribute_Single	Req.	Read an attribute
16#10	Set_Attribute_Single	Opt.	Write an attribute

13. CIP objects

13. 10. Assembly object

The Assembly object binds together the attributes of multiple objects so that information to or from each object can be communicated over a single connection.

Assembly objects are static.

The assemblies in use can be modified through the parameter access of the network configuration tool (RSNetWorx).

The drive needs a power off to take into account a new assembly assignment.

Class code

Hexadecimal	Decimal
16#04	4

Class attribute

Attribute ID	Access	Name	Need	Data type	Value	Details
1	Get	Revision	Opt.	UINT	2	—
2	Get	Max instance	Opt.	UINT	105	13 defined instances

Instances supported

Instance	Name	Data size
20	ODVA Basic speed control output	4 bytes
21	ODVA Extended speed control output	4 bytes
22	ODVA Speed and torque control output	6 bytes
23	ODVA Extended speed and torque control output	6 bytes
100	Native drive output	16 bytes
103	Allen-Bradley® drive output	20 bytes
70	ODVA Basic speed control input	4 bytes
71	ODVA Extended speed control input	4 bytes
72	ODVA Speed and torque control input	6 bytes
73	ODVA Extended speed and torque control input	6 bytes
101	Native drive input	16 bytes
104	Allen-Bradley® drive input	20 bytes

The description of each instance is detailed in chapter [15. Device profiles](#)

Instance attributes

Attribute ID	Access	Name	Need	Data type	Value	Details
3	Get/Set (1)	Data	Req.			

(1) Set access is restricted to output instances only (instances 20, 21, 22, 23, 100 and 103).

Class service

Service code	Service name	Need	Description
16#0E	Get_Attribute_Single	Req.	Read an attribute

Instance service

Service code	Service name	Need	Description
16#0E	Get_Attribute_Single	Req.	Read an attribute
16#10	Set_Attribute_Single	Opt.	Write an attribute

13. CIP objects

13. 11. Application objects

Class code

Hexadecimal	Decimal
16#70 to 16#A8	112 to 424

Altivar parameters path

The Altivar parameters are grouped in classes.
Each application class has only 1 instance.
Each instance groups 200 parameters.
Each attribute in an instance relates to a parameter.

The first parameter registered in the first application class (class code: 16#70 = 112) has the logical address 3000.

Examples:

Logical address	Path Hexadecimal	Path decimal
3 000	16# 70 / 01 / 01	112 / 1 / 1
3 100	16# 70 / 01 / 65	112 / 1 / 101
3 200	16# 71 / 01 / 01	113 / 1 / 1
64 318	16# A2 / 1 / 77	418 / 1 / 119

Refer to the Communication parameters manual.

Class attributes

Attribute ID	Access	Name	Need	Data type	Value
1	Get	Revision	Opt.	UINT	1
2	Get	Max instance	Opt.	UINT	1
6	Get	Max ID number of class attribute	Opt.	UINT	7
7	Get	Max ID number of instance attribute	Opt.	UINT	X

Instance attributes

Attribute ID	Access	Name	Data type	Value
1	Get/Set	First parameter of the class	UINT / USINT	Value returned by the drive
...
X	Get/Set	Last parameter of the class	UINT / USINT	Value returned by the drive

Note: Depending on the parameter, write access may be prohibited. Refer to the Communication parameters manual for more information.

Class service

Service code	Service name	Need	Description
16#0E	Get_Attribute_Single	Req.	Read an attribute

Instances service

Service code	Service name	Need	Description
16#0E	Get_Attribute_Single	Req.	Read an attribute
116#0	Set_Attribute_Single	Opt.	Write an attribute

13. CIP objects

■ Object 2Ahex (AC/DC Drive)

Path	CIP name	CIP configuration parameter name
16#2A/01/07 = 42/1/7	SpeedActual	Speed Actual
16#2A/01/08 = 42/1/8	SpeedRef	Speed Reference
16#2A/01/09 = 42/1/9	CurrentActual	Current Actual
16#2A/01/0A = 42/1/10	CurrentLimit	Current Limit
16#2A/01/0B = 42/1/11	TorqueActual	Torque Actual
16#2A/01/0C = 42/1/12	TorqueRef	Torque Reference
16#2A/01/12 = 42/1/18	AccelTime	Accel Time
16#2A/01/13 = 42/1/19	DecelTime	Decel Time
16#2A/01/14 = 42/1/20	LowSpdLimit	Low Speed Limit
16#2A/01/15 = 42/1/21	HighSpdLimit	High Speed Limit

Telemecanique adaptation:

Path	Code	Altivar name	Logic address	Unit Id
16#2A/01/07 = 42/1/7	RFRD	Output velocity	16#219C = 8604	
16#2A/01/08 = 42/1/8	LFRD	Speed setpoint	16#219A = 8602	
16#2A/01/09 = 42/1/9	LCR	Motor current	16#0C84 = 3204	
16#2A/01/0A = 42/1/10	ITH	Mot. therm. current	16#2596 = 9622	
16#2A/01/0B = 42/1/11	Otrn	Output torque (Nm)	16#2A0B = 10763	251
16#2A/01/0C = 42/1/12	n.a.	Torque setpoint (Nm)	16#2A0C = 10764	251
16#2A/01/12 = 42/1/18	ACCD	CIP acceleration time	16#2A12 = 10770	251
16#2A/01/13 = 42/1/19	DECD	CIP deceleration time	16#2A13 = 10771	251
16#2A/01/14 = 42/1/20	LSPD	CIP Low speed limit	16#2A14 = 10772	251
16#2A/01/15 = 42/1/21	HSPD	CIP High speed limit	16#2A15 = 10773	251

14. Explicit Messaging

The following example shows an example of explicit messaging: The value of the ACC parameter (Modbus @ = 9001 / CIP address 16#2A:1:16#12) is modified when the variable "bit01" is toggled ON.

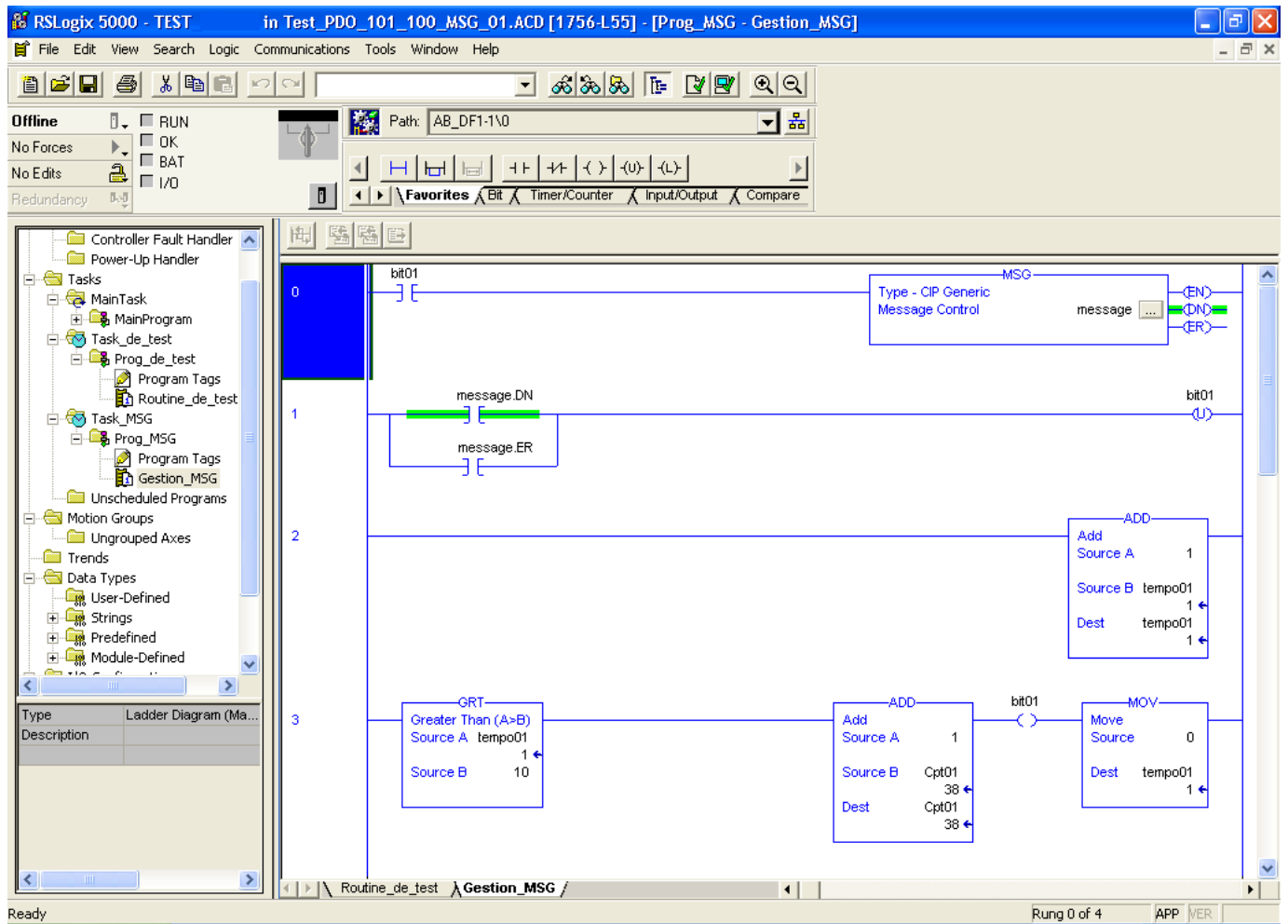

The detailed configuration of the message Box:

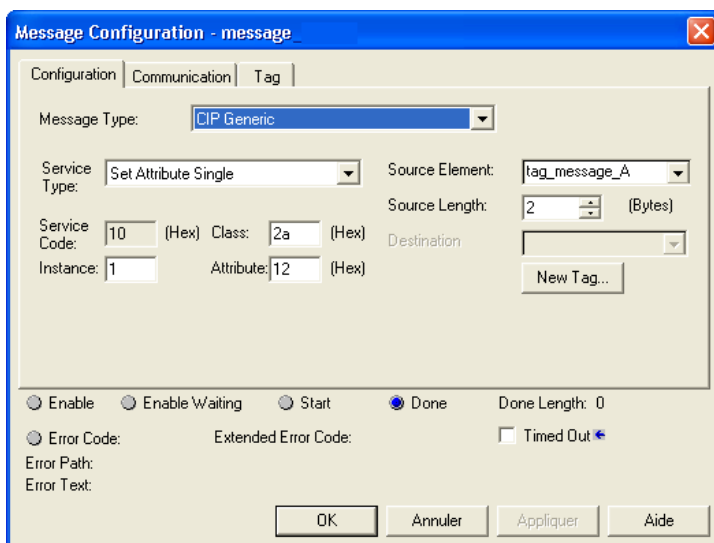

15. Device profiles

EtherNet/IP card provides several profiles:

- CIP AC drive profile (0x02) (default setting),
- Allen Bradley drive profile,
- Telemecanique: CiA 402 and I/O.

The profile is chosen by the selection of the right input assembly and output assembly.

In this manual, the chapter "Integration in RSLogix 5000" shows how the user may select the assemblies.

■ List of assemblies

Output assemblies

Assembly name	Number	Size
CIP basic speed control output	20	2 words (4 bytes)
CIP extended speed control output	21	2 words (4 bytes)
CIP speed and torque control output	22	3 words (6 bytes)
CIP extended speed and torque control output	23	3 words (6 bytes)
Native drive output	100	2 to 10 words (4 to 20 bytes)
Allen-Bradley® drive output	103	2 to 10 words (4 to 20 bytes)

Input assemblies

Assembly name	Number	Size
CIP basic speed control input	70	2 words (4 bytes)
CIP extended speed control input	71	2 words (4 bytes)
CIP speed and torque control input	72	3 words (6 bytes)
CIP extended speed and torque control input	73	3 words (6 bytes)
Native drive input	101	2 to 10 words (4 to 20 bytes)
Allen-Bradley® drive input	104	2 to 10 words (4 to 20 bytes)

IMPORTANT REMARK:

For the assemblies 20 and 22, the default settings defines that the speed setpoint is originated from the terminals. To fully control the drive from the network the following operation is required:

The object 2A/1/4 (netref) must be changed from 0 to 1 (byte). Such assignment can be done:

- By program, with an MSG() instruction block.
- With the Class instance editor:

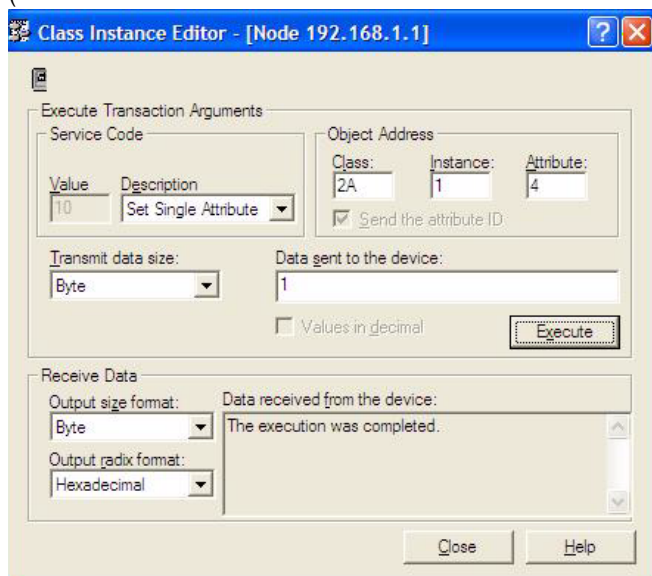

15. Device profiles

■ Assembly 20: CIP basic speed control output

Assembly mapping

Word number	Definition
0	CIP basic command word
1	Speed setpoint (rpm)

CIP basic command word

Bit 7	Bit 6	Bit 5	Bit 4	Bit 3	Bit 2	Bit 1	Bit 0
Not used	Not used	Not used	Not used	Not used	Fault reset (1) 0 = No command 1 = Fault reset	Not used	Run Forward (2) 0 = Stop 1 = Run

(1) Active on rising edge.

(2) Active on level.

Bit 15	Bit 14	Bit 13	Bit 12	Bit 11	Bit 10	Bit 9	Bit 8
Not used	Not used	Not used	Not used	Not used	Not used	Not used	Not used

■ Assembly 70: CIP basic speed control input

Assembly mapping

Word number	Definition
0	CIP basic status word
1	Actual speed (rpm)

CIP basic status word

Bit 7	Bit 6	Bit 5	Bit 4	Bit 3	Bit 2	Bit 1	Bit 0
Not used	Not used	Not used	Not used	Not used	Running 0 = Stopped 1 = Running	Not used	Faulted 0 = No fault 1 = Fault

Bit 15	Bit 14	Bit 13	Bit 12	Bit 11	Bit 10	Bit 9	Bit 8
Not used	Not used	Not used	Not used	Not used	Not used	Not used	Not used

■ Assembly 21: CIP extended speed control output

Assembly mapping

Word number	Definition
0	CIP extended command word
1	Speed setpoint (rpm)

CIP extended command word

Bit 7	Bit 6	Bit 5	Bit 4	Bit 3	Bit 2	Bit 1	Bit 0
Not used	Network setpoint 0 = Setpoint by terminals 1 = Setpoint by network	Network command 0 = Command by terminals 1 = Command by network	Not used	Not used	Fault reset (1) 0 = No command 1 = Fault reset	Run forward / reverse 00 = Quick stop 01 = Run forward 10 = Run reverse 11 = Freewheel stop	

Bit 15	Bit 14	Bit 13	Bit 12	Bit 11	Bit 10	Bit 9	Bit 8
Not used	Not used	Not used	Not used	Not used	Not used	Not used	Not used

(1) Active on rising edge.

15. Device profiles

■ Assembly 71: CIP extended speed control input

Assembly mapping

Word number	Definition
0	CIP extended status word
1	Actual speed (rpm)

CIP extended status word

Bit 7	Bit 6	Bit 5	Bit 4	Bit 3	Bit 2	Bit 1	Bit 0
At reference 0 = Reference not reached 1 = Reference reached	Setpoint from network 0 = Setpoint from terminals 1 = Setpoint from network	Command from network 0 = Command from terminals 1 = Command from network	Ready 0 = Not ready 1 = Ready	Running forward / reverse 00 = Stopped 01 = Running forward 10 = Running reverse 11 = Not used	Warning 0 = No warning 1 = Warning	Not used	

Bit 15	Bit 14	Bit 13	Bit 12	Bit 11	Bit 10	Bit 9	Bit 8
Not used	Not used	Not used	Not used	Not used	Bit 8 to bit 10 are used for the drive state 000 = Not used 001 = Startup 010 = Not Ready 011 = Ready 100 = Enabled 101 = Stopping 110 = Fault Stop 111 = Faulted		

■ Assembly 22: CIP speed and torque control output

Assembly mapping

Word number	Definition
0	CIP basic command word (1)
1	Speed setpoint (rpm)
2	Torque setpoint (Nm)

(1) Refer to assembly 20.

■ Assembly 72: CIP speed and torque control input

Assembly mapping

Word number	Definition
0	CIP basic status word (1)
1	Actual speed (rpm)
2	Actual torque (Nm)

(1) Refer to assembly 70.

■ Assembly 23: CIP extended speed and torque control output

Assembly mapping

Word number	Definition
0	CIP extended command word (1)
1	Speed setpoint (rpm)
2	Torque setpoint (Nm)

(1) Refer to assembly 21.

15. Device profiles

■ Assembly 73: CIP extended speed and torque control input

Assembly mapping

Word number	Definition
0	CIP extended status word (1)
1	Actual speed (rpm)
2	Actual torque (Nm)

(1) Refer to assembly 71.

■ Assembly 100: Native drive output

Assembly mapping

Word number	Definition
0	Control word
1	Velocity setpoint
2	Scanner write word 1
3	Scanner write word 2
4	Scanner write word 3
5	Scanner write word 4
6	Scanner write word 5
7	Scanner write word 6

Altivar 71/61 assignment

Word number	Code	Name	Logic address
0	NC1	Communication scanner, value of write word 1 (default value :CMD, Control word)	16#31D9 = 12761
1	NC2	Communication scanner, value of write word 2 (default value: LFRD, velocity setpoint)	16#31DA = 12762
2	NC3	Communication scanner, value of write word 3	16#31DB = 12763
3	NC4	Communication scanner, value of write word 4	16#31DC = 12764
4	NC5	Communication scanner, value of write word 5	16#31DD = 12765
5	NC6	Communication scanner, value of write word 6	16#31DE = 12766
6	NC7	Communication scanner, value of write word 7	16#31DF = 12767
7	NC8	Communication scanner, value of write word 8	16#31E0 = 12768

Note: The default assignment of NC1 and NC2 must be changed to "Not assigned".

15. Device profiles

■ Assembly 101: Native drive input

Assembly mapping

Word number	Definition
0	Scanner read word 1
1	Scanner read word 2
2	Scanner read word 3
3	Scanner read word 4
4	Scanner read word 5
5	Scanner read word 6
6	Scanner read word 7
7	Scanner read word 8

Altivar 71/61 assignment

Word number	Code	Name	Logic address
0	NM1	Communication scanner, value of read word 1 (default value: Status word, ETA)	16#31C5 = 12741
1	NM2	Communication scanner, value of read word 2 (default value: Velocity actual value, RFRD)	16#31C6 = 12742
2	NM3	Communication scanner, value of read word 3	16#31C7 = 12743
3	NM4	Communication scanner, value of read word 4	16#31C8 = 12744
4	NM5	Communication scanner, value of read word 5	16#31C9 = 12745
5	NM6	Communication scanner, value of read word 6	16#31CA = 12746
6	NM7	Communication scanner, value of read word 7	16#31CB = 12747
7	NM8	Communication scanner, value of read word 8	16#31CC = 12748

15. Device profiles

■ Assembly 103: Allen-Bradley® drive output

Assembly mapping

Word number	Definition
0	Allen-Bradley® drive logic command
1	Standardized speed setpoint (reference)
2	Scanner write word 1
3	Scanner write word 2
4	Scanner write word 3
5	Scanner write word 4
6	Scanner write word 5
7	Scanner write word 6
8	Scanner write word 7
9	Scanner write word 8

Altivar 71/61 assignment

Word number	Code	Name	Logic address
0	n.a.	Allen-Bradley® drive logic command	n.a.
1	LFR	Frequency setpoint	16#2136 = 8502
2	NC1	Communication scanner, value of write word 1	16#31D9 = 12761
3	NC2	Communication scanner, value of write word 2	16#31DA = 12762
4	NC3	Communication scanner, value of write word 3	16#31DB = 12763
5	NC4	Communication scanner, value of write word 4	16#31DC = 12764
6	NC5	Communication scanner, value of write word 5	16#31DD = 12765
7	NC6	Communication scanner, value of write word 6	16#31DE = 12766
8	NC7	Communication scanner, value of write word 7	16#31DF = 12767
9	NC8	Communication scanner, value of write word 8	16#31E0 = 12768

Note: The default assignment of NC1 and NC2 must be changed to another value or to not assigned..

15. Device profiles

■ Allen-Bradley® drive logic command

The logic command is a 16-bit word of control produced by the scanner and consumed by the EtherNet/IP card.

If enabled, the Logic command word is always word 0 in the output image.

Bit 7	Bit 6	Bit 5 Bit 4	Bit 3	Bit 2	Bit 1	Bit 0
MOP Increment 0 = Not Increment 1 = Increment	Local control 0 = No local control 1 = Local control	Direction 00 = No command (4) 01 = Forward command 10 = Reverse command 11 = Hold direction control	Clear faults (3) 0 = Not clear faults 1 = Clear faults	Jog 0 = Not jog 1 = Jog	Start (2) 0 = Not start 1 = Start	Stop (1) 0 = Not stop 1 = Stop

Bit 15	Bit 14	Bit 13	Bit 12	Bit 11 Bit 10	Bit 9 Bit 8
MOP Decrement 0 = Not decrement 1 = Decrement	Reference select 000 = No command (7) 001 = Setpoint 1 channel (Fr1) 010 = Setpoint 2 channel (Fr2) 011 = Ref. 3 (Preset 3) 100 = Ref. 4 (Preset 4) 101 = Ref. 5 (Preset 5) 110 = Ref. 6 (Preset 6) 111 = Ref. 7 (Preset 7)			Decel rate 00 = No command (6) 01 = Decel rate 1 command 10 = Decel rate 2 command 11 = Hold decel rate	Accel rate 00 = No command (5) 01 = Accel rate 1 command 10 = Accel rate 2 command 11 = Hold accel rate

- (1) Stop: Active at level.
- (2) Start: Active on rising edge. A Not stop condition (logic 0 = 0) must first be present before a Start condition (logic 1 = 1) will start the drive.
- (3) Clear faults: Active on rising edge. To perform this command, the value must switch from "0" to "1."
- (4) Direction \ No command: If a direction is selected acts like Hold direction control.
- (5) Accel rate \ No command: If a rate is selected acts like Hold accel rate.
- (6) Decel rate \ No command: If a rate is selected acts like Hold decel rate.
- (7) Reference select \ No command: If a rate is selected acts like Hold command.

■ Altivar 71/61 assignment

Bit 7	Bit 6	Bit 5 Bit 4	Bit 3	Bit 2	Bit 1	Bit 0
Not used	Not used	Direction 00 = No command (4) 01 = Forward command 10 = Reverse command 11 = Hold direction control	Clear faults (3) 0 = Not clear faults 1 = Clear faults	Not used	Start (2) 0 = Not start 1 = Start	Stop (1) 0 = Not stop 1 = Stop

Bit 15	Bit 14	Bit 13	Bit 12	Bit 11	Bit 10	Bit 9	Bit 8
Not used	Setpoint select 000 = No command 001 = Terminals 010 = Control by network 011 = Preset 3 100 = Preset 4 101 = Preset 5 110 = Preset 6 111 = Preset 7			Not used	Not used	Not used	Not used

15. Device profiles

■ Standardised setpoint

The setpoint (16 bits only) is produced by the controller and consumed by the EtherNet/IP card. If enabled, the setpoint is always word 1 in the output image.

The setpoint value is a standardised (e.g. scaled) value; it is not an engineering value.

Telemecanique adaptation

[Frequency setpoint] ($L F r$) shall be configured in high resolution: standardised value on 16 signed bits at maximum frequency. The value 32767 corresponds to the parameter [Max frequency] ($\pm F r$). The default value of the parameter [Max frequency] ($\pm F r$) is 60 Hz, and the resolution is then approximately 0.0018 Hz.

Note:

The commanded maximum speed can never exceed the value of the parameter [High speed] (HSP).

The table below shows example setpoints and their results on an Altivar drive that has its parameter [Max frequency] ($\pm F r$) set to 130 Hz and its parameter [High speed] (HSP) set to 60 Hz.

Setpoint value	Scale		Output speed	Feedback value
	Percent	Value		
32767 (1)	100%	130 Hz	60 Hz (2)	15123 (3)
16384	50%	65 Hz	60 Hz (2)	15123 (3)
8192	25%	32.5 Hz	32.5 Hz	8192
0	0%	0 Hz	0 Hz	0

(1) A value of 32767 is equivalent to the parameter [Max frequency] ($\pm F r$) frequency value. Values greater than 32767 reverse speed.

(2) The drive runs at 60 Hz instead of 130 Hz or 65 Hz because the parameter [High speed] (HSP) sets 60 Hz as the maximum speed.

(3) The feedback value is also scaled based on the value of the parameter [Max frequency] ($\pm F r$), for example, $60/130 = 0.46$ so $32767 \times 0.46 = 15123$.

■ Assembly 104: Allen-Bradley® drive input

Assembly mapping

Word number	Definition
0	Allen-Bradley® drive logic status
1	Speed feedback (actual value)
2	Scanner read word 1
3	Scanner read word 2
4	Scanner read word 3
5	Scanner read word 4
6	Scanner read word 5
7	Scanner read word 6
8	Scanner read word 7
9	Scanner read word 8

Word number	Code	Name	Logic address
0	n.a.	Allen-Bradley® drive logic status	n.a.
1	RFR	Output frequency	16#0C82 = 3202
2	NM1	Communication scanner, value of read word 1	16#31C5 = 12741
3	NM2	Communication scanner, value of read word 2	16#31C6 = 12742
4	NM3	Communication scanner, value of read word 3	16#31C7 = 12743
5	NM4	Communication scanner, value of read word 4	16#31C8 = 12744
6	NM5	Communication scanner, value of read word 5	16#31C9 = 12745
7	NM6	Communication scanner, value of read word 6	16#31CA = 12746
8	NM7	Communication scanner, value of read word 7	16#31CB = 12747
9	NM8	Communication scanner, value of read word 8	16#31CC = 12748

Note: The default assignment of NM1 and NM2 must be changed to "Not assigned".

15. Device profiles

■ Allen-Bradley® drive logic status

The Logic Status is a 16-bit word of status produced by the EtherNet/IP card and consumed by the scanner. If enabled, the Logic status word is always word 2 in the input image.

Bit 7	Bit 6	Bit 5	Bit 4	Bit 3	Bit 2	Bit 1	Bit 0
Fault	Alarm	Decelerating	Accelerating	Actual direction	Command direction	Active	Ready
0 = No fault 1 = Fault	0 = No alarm 1 = Alarm	0 = Not decelerating 1 = Decelerating	0 = Not accelerating 1 = Accelerating	0 = Reverse 1 = Forward	0 = Reverse 1 = Forward	0 = Not active 1 = Active	0 = Not ready 1 = Ready

Bit 15	Bit 14	Bit 13	Bit 12	Bit 11	Bit 10	Bit 9	Bit 8
Reference				Local control			At speed
0000 = Ref A auto 0001 = Ref B auto 0010 = Preset 2 auto 0011 = Preset 3 auto 0100 = Preset 4 auto 0101 = Preset 5 auto 0110 = Preset 6 auto 0111 = Preset 7 auto 1000 = Term blk manual 1001 = DPI 1 manual 1010 = DPI 2 manual 1011 = DPI 3 manual 1100 = DPI 4 manual 1101 = DPI 5 manual 1110 = DPI 6 manual 1111 = Jog reference				000 = Port 0 (TB) 001 = Port 1 010 = Port 2 011 = Port 3 100 = Port 4 101 = Port 5 110 = Port 6 111 = No local			0 = Not at reference 1 = At reference

Telemecanique adaptation

Bit 7	Bit 6	Bit 5	Bit 4	Bit 3	Bit 2	Bit 1	Bit 0
Fault	Alarm	Decelerating	Accelerating	Actual direction	Command direction	Running	Ready
0 = No fault 1 = Fault	0 = No alarm 1 = Alarm	0 = Not decelerating 1 = Decelerating	0 = Not accelerating 1 = Accelerating	0 = Reverse 1 = Forward	0 = Reverse 1 = Forward	0 = Not active 1 = Active	0 = Not ready 1 = Read

Bit 15	Bit 14	Bit 13	Bit 12	Bit 11	Bit 10	Bit 9	Bit 8
Setpoint source				Control source			At speed
0000 = Terminals 0001 = not used 0010 = Preset 2 0011 = Preset 3 0100 = Preset 4 0101 = Preset 5 0110 = Preset 6 0111 = Preset 7 1000 = not used 1001 = Graphic display terminal 1010 = Modbus 1011 = CANopen 1100 = PC-Software 1101 = EtherNet/IP card 1110 = Controller inside 1111 = not used				000 = Terminals 001 = Graphic display terminal 010 = Modbus 011 = CANopen 100 = PC-Software 101 = EtherNet/IP card 110 = Controller inside 111 = not used			0 = Not at reference 1 = At reference

Note: When the value of Setpoint source (bits 12, 13, 14 and 15) is Preset speed x, it means that the corresponding command is given by the assembly 103 via Setpoint select (bits 12,13 and 14) (not by the terminals).

16. Configuring an ATV71/61 in replacement of a Powerflex® drive

This chapter illustrates of to proceed to exchange Powerflex® drive an ATV71. This example has been realized by RSLogix® software. There are three way to configure the drive equipped with an EtherNet/IP card.

IMPORTANT NOTE:

The ATV71/61 provides several assembly sets. Assembly 103 and 104 emulates the Powerflex drive assemblies. But for compatibility reasons these assemblies can also use number 1 and 2. This means that in the ATV71/61:

- output assembly 103 and 2 are identical,
- input assembly 104 and 1 are identical.

In the following example, we start with an application based on a network made of a single VSD (a Powerflex drive). The following pages describe how to replace it by an ATV71 .

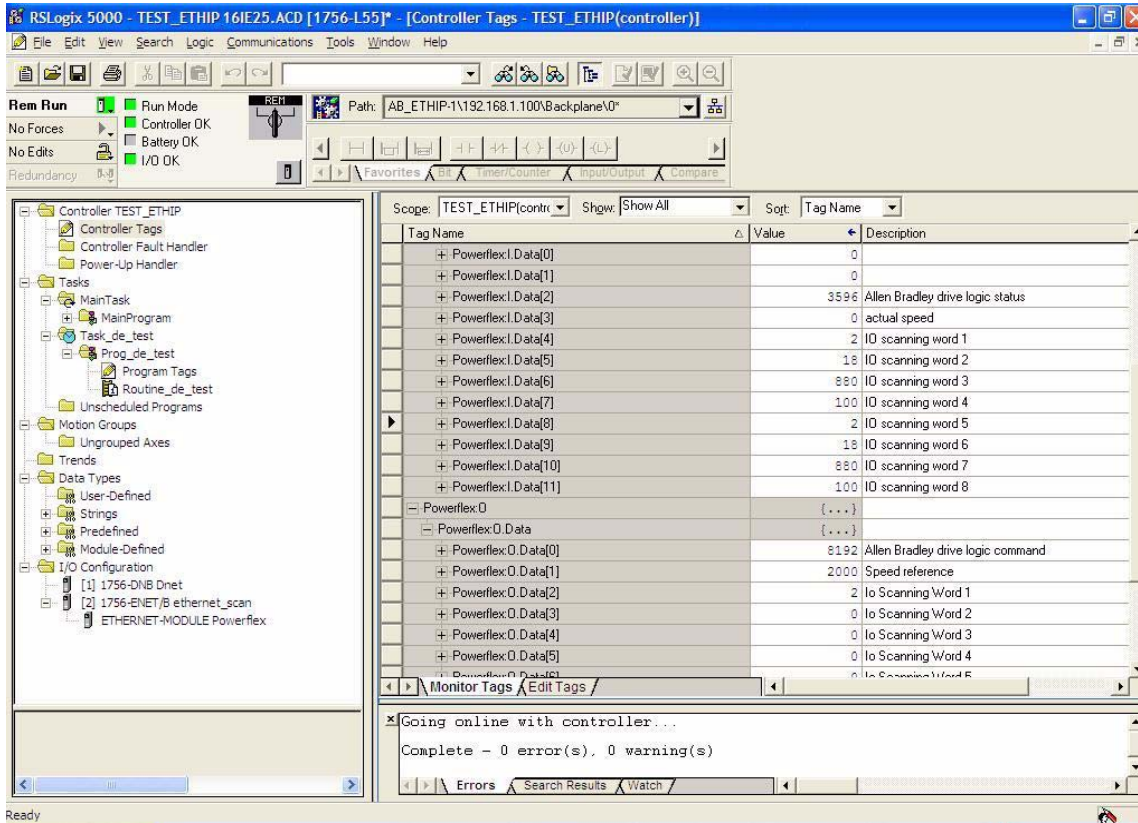

16. Configuring an ATV71/61 in replacement of a Powerflex® drive

Put the RSLogix environment Offline:

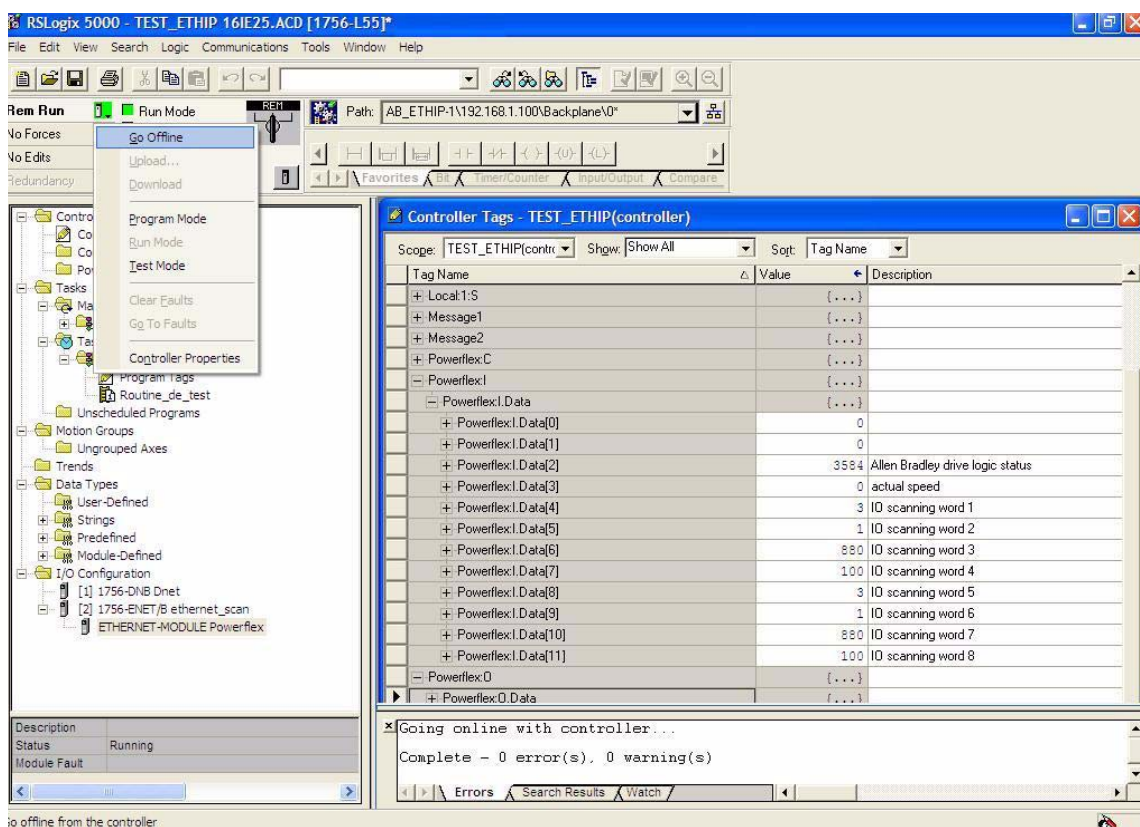

Then edit the module properties of the "ETHERNET MODULE Powerflex" by double-clicking in the navigation tree.

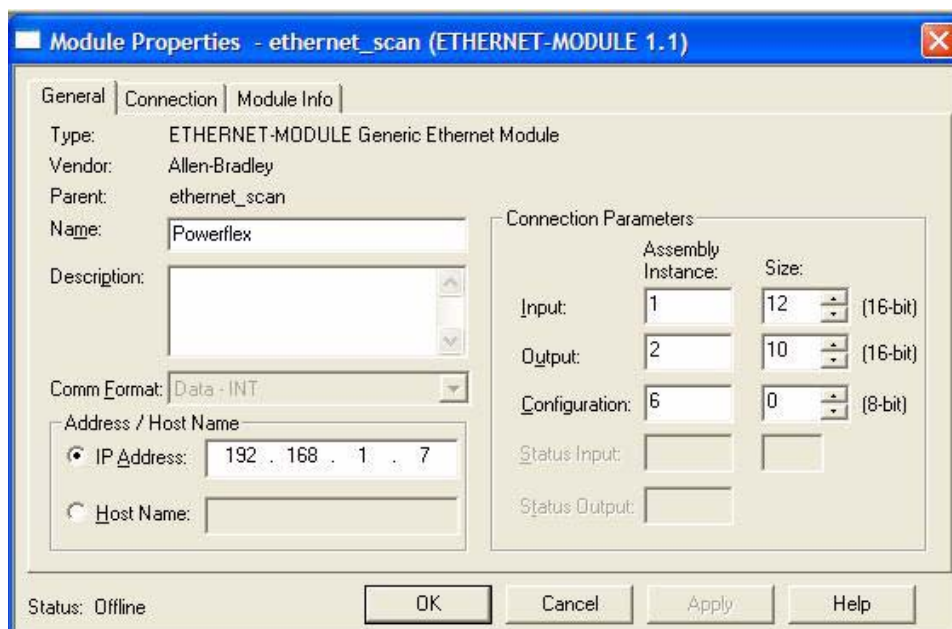

16. Configuring an ATV71/61 in replacement of a Powerflex® drive

Notice that only the Module Name is changed.

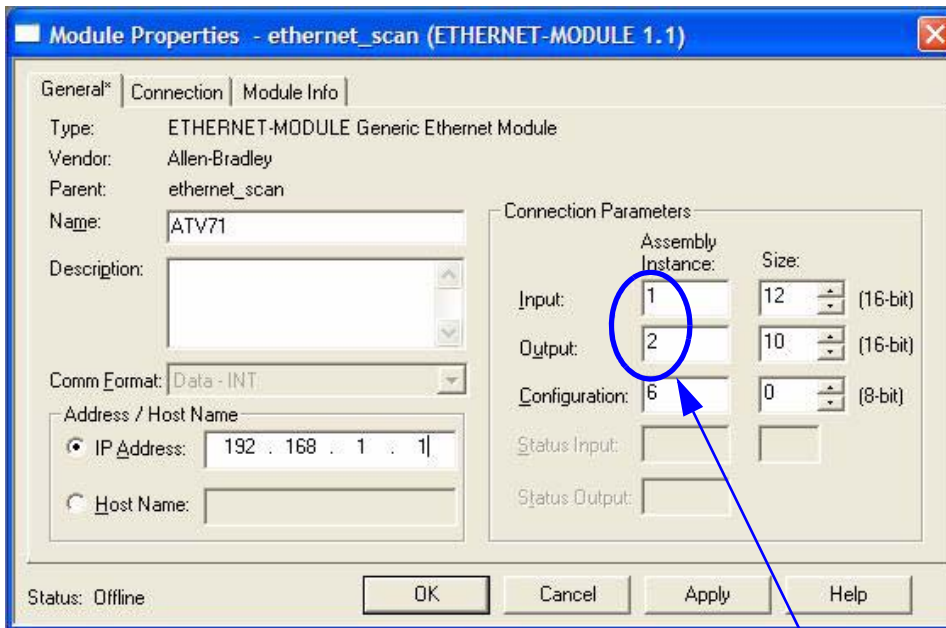

Here, we have used Assemblies 1 and 2 (As Powerflex VSD).

But Assemblies 103 and 104 could also be used, like in the dialog box below.

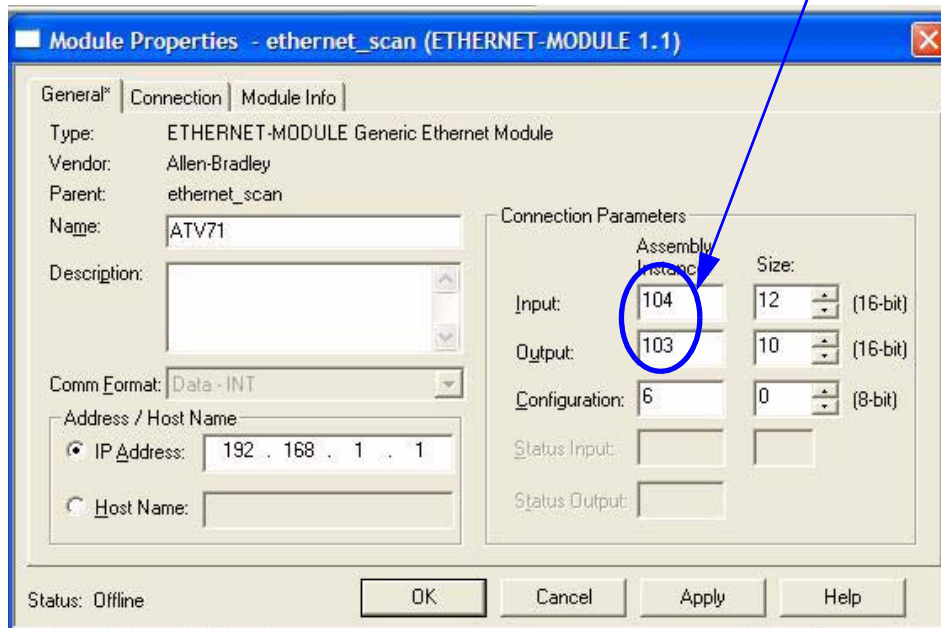

Confirm the modification by OK, save the project and download it to the PLC.

16. Configuring an ATV71/61 in replacement of a Powerflex® drive

Now, switch to RSNetworx, The old configuration is always displayed:

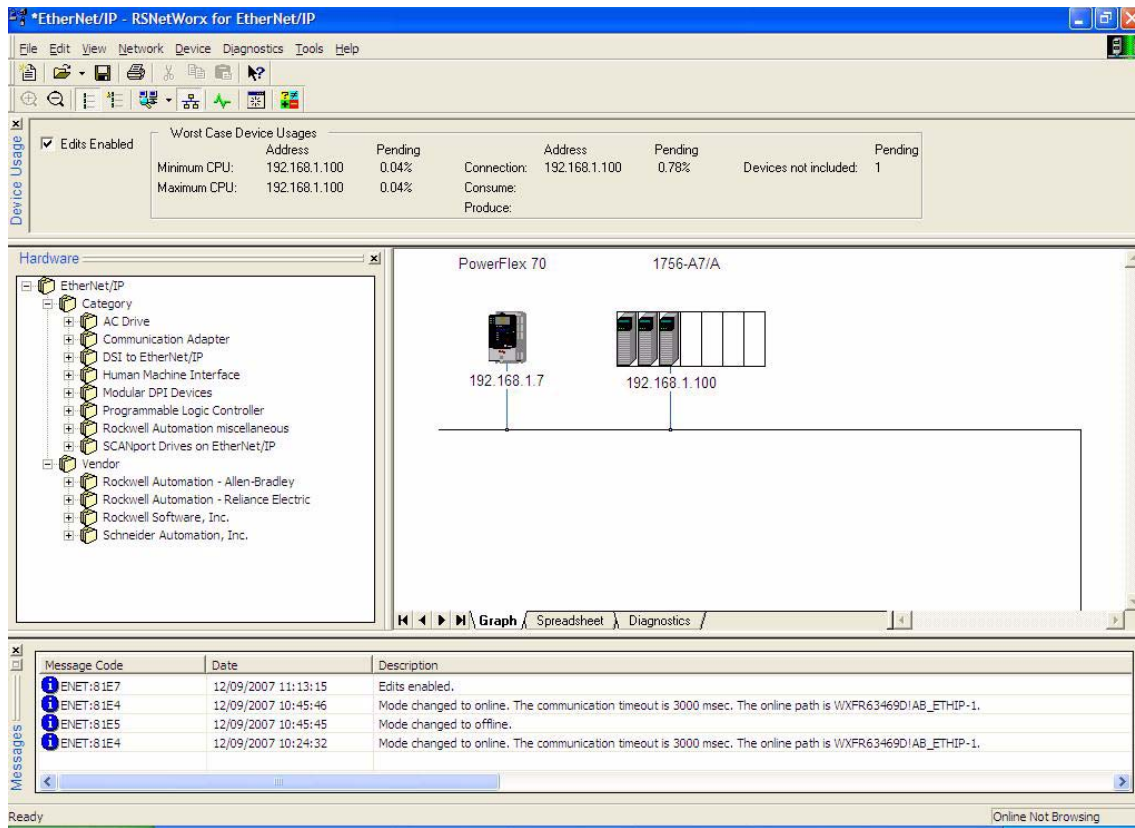

Browse the whole Network:

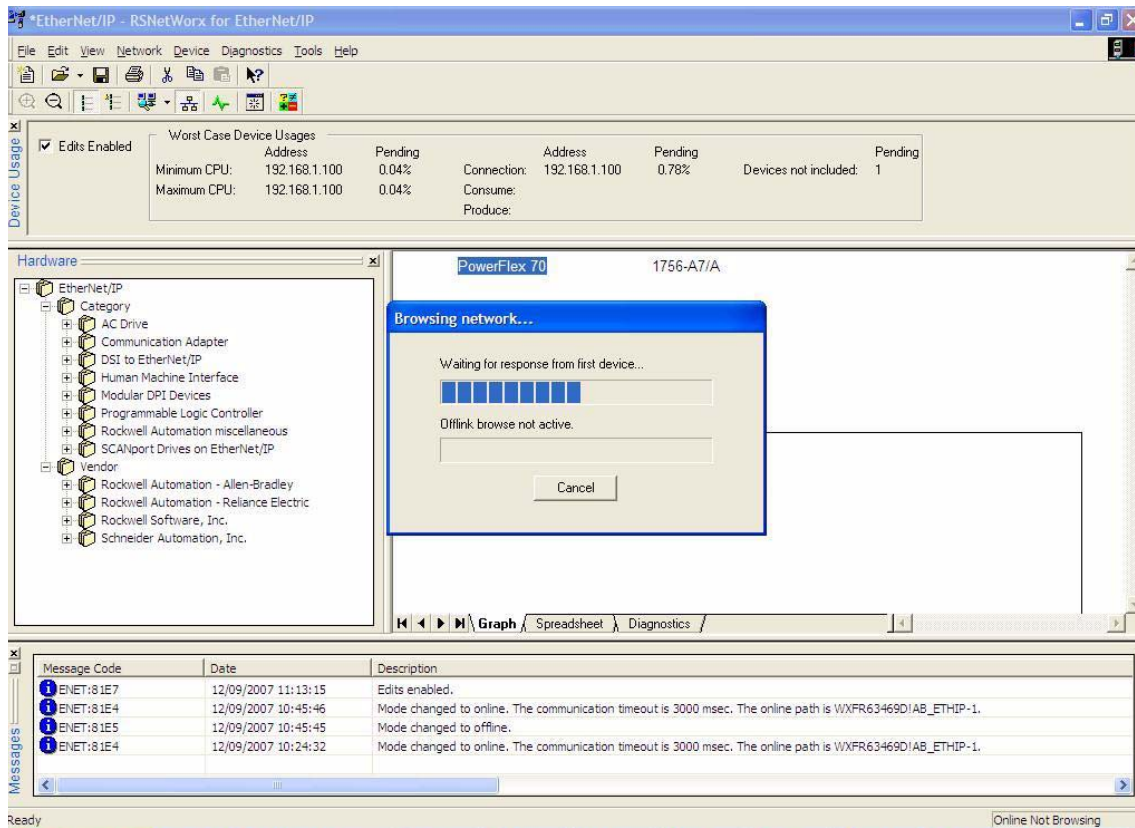

16. Configuring an ATV71/61 in replacement of a Powerflex® drive

Once the network has been scanned, you should obtain this:

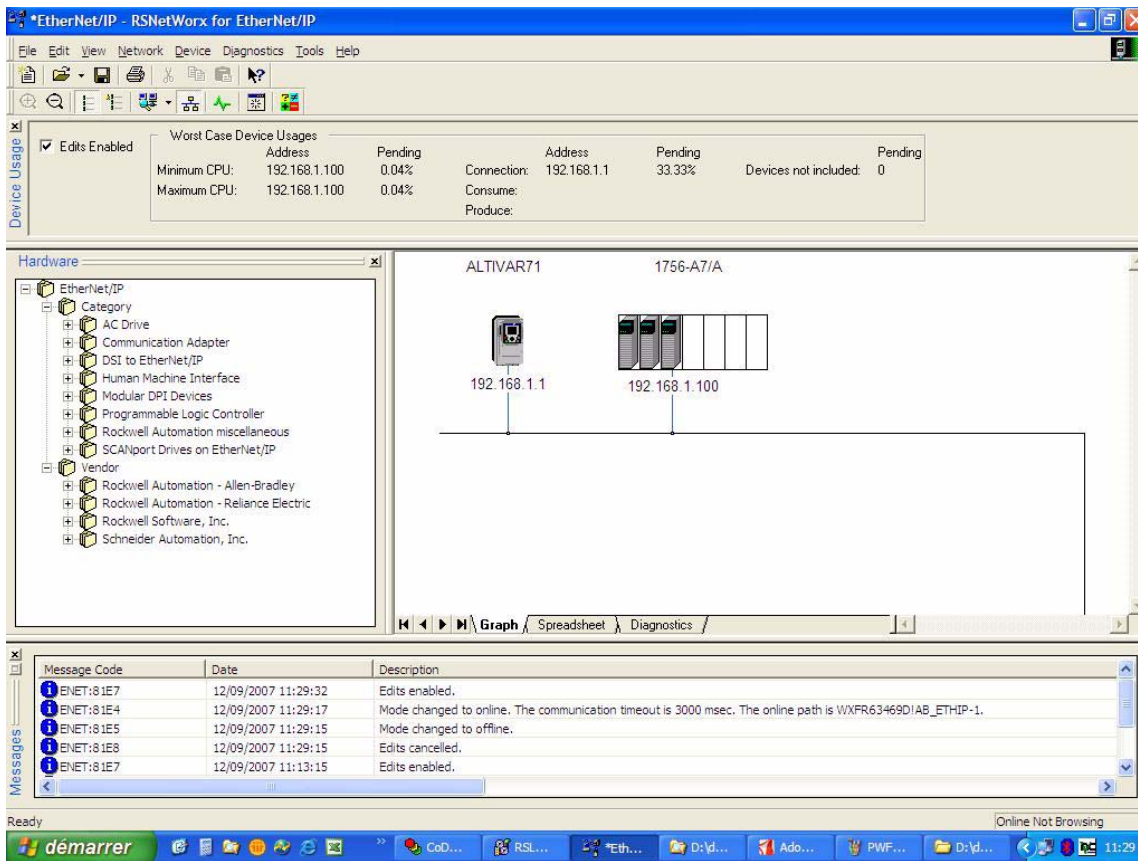

This last screen shows the data screen of the ATV71.

