

Altivar 61/71

Modbus TCP/IP

Daisy Chain Ethernet card

User manual

VW3 A3 310d

01/2011

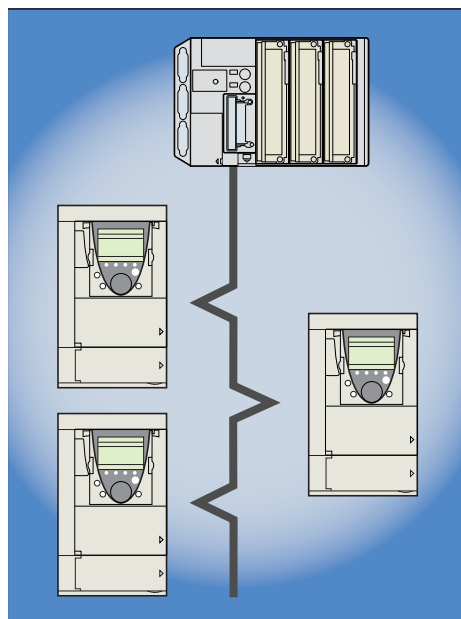

Table of contents

Important Information	5
Before you begin	6
Documentation structure	7
Introduction	8
Presentation	8
Notation	8
Hardware setup	9
Receipt	9
Hardware description	9
Installing the card in the drive	9
Connecting to the Ethernet network	10
Card RJ45 connector pinout	10
Example of connection to an Ethernet network	10
Ethernet network connection elements	11
Ethernet menu	12
Access to Ethernet menu via graphic display terminal	12
Access to Ethernet menu via the integrated display terminal	12
Ethernet menu parameters	13
Configuration	16
List of functions to be configured	16
Configuring IP addresses	17
Reserving control	19
Configuring IO Scanning	19
Configuring the control	20
Configuring the fault management	23
Configuring monitored parameters	25
Diagnostics	26
Signalling LEDs	26
Available information	27
Monitoring the control	27
Troubleshooting the communication fault	28
Troubleshooting the card fault	29
Software setup	30
List of services supported	30
TCP connections	30
Modbus TCP server	31
Modbus TCP frames	31
Drive Modbus servers	31
Ethernet card parameters	32
List of Modbus functions supported	35
"Read Holding Registers" (3) function	35
"Write Single Register" (6) function	36
"Write Multiple Registers" (16 = 16#10) function	37
"Read/Write Multiple Registers" (23 = 16#17) function	38
"Read Device Identification" (43 = 16#2B) function	39
IO Scanning service	40
Presentation	40
Periodic variables	40
Address table	41
FDR service	42
Presentation	42
Local configuration	43
Downloaded configuration	44
Periodic saving	46
Other commands	46
Configuration file	46

Table of contents

Standard Web server	47
Web server functions	47
Applets	48
Access to the Web server	49
Web server user interface	50
"Home" menu	50
"Monitoring" menu	50
"Altivar Viewer" page	51
"Data Viewer" page	52
"Altivar Chart" page	53
"Diagnostics" menu	53
"Ethernet Statistics" page	54
"Setup" menu	54
"HTTP password" and "Data write password pages"	55
"FDR Agent" page	56
"IO Scanner" page	58
"Email" page	61
"Documentation" menu	62
FTP server	63
Downloading from the Web server	65
SNMP agent	68
Setup using PL7	70
Setup using Concept	76
Setup using ProWORX NxT	77

1. Important Information

NOTICE

Read these instructions carefully, and look at the equipment to become familiar with the device before trying to install, operate, or maintain it. The following special messages may appear throughout this documentation or on the equipment to warn of potential hazards or to call attention to information that clarifies or simplifies a procedure.



The addition of this symbol to a Danger or Warning safety label indicates that an electrical hazard exists, which will result in personal injury if the instructions are not followed.



This is the safety alert symbol. It is used to alert you to potential personal injury hazards. Obey all safety messages that follow this symbol to avoid possible injury or death.

DANGER

DANGER indicates an imminently hazardous situation, which, if not avoided, **will result** in death, serious injury, or equipment damage.

WARNING

Warning indicates a potentially hazardous situation, which, if not avoided, **can result** in death, serious injury, or equipment damage.

CAUTION

CAUTION indicates a potentially hazardous situation, which, if not avoided, **can result** in injury or equipment damage.

PLEASE NOTE

Electrical equipment should be serviced only by qualified personnel. No responsibility is assumed by Schneider Electric for any consequences arising out of the use of this material. This document is not intended as an instruction manual for untrained persons.
© 2006 Schneider Electric. All Rights Reserved.

2. Before you begin

Read and understand these instructions before performing any procedure with this drive.

DANGER

HAZARDOUS VOLTAGE

- Read and understand this bulletin in its entirety before installing or operating Altivar 61 / 71 drive. This equipment must only be installed, adjusted, repaired, and maintained by qualified personnel.
- The user is responsible for compliance with all international and national electrical standards in force concerning protective grounding of all equipment.
- Many parts of this variable speed drive, including the printed circuit boards, operate at the line voltage. DO NOT TOUCH. Use only electrically insulated tools.
- DO NOT touch unshielded components or terminal strip screw connections with voltage present.
- DO NOT short across terminals PA and PC or across the DC bus capacitors.
- Install and close all the covers before applying power or starting and stopping the drive.
- Before servicing the variable speed drive
 - Disconnect all power.
 - Place a "DO NOT TURN ON" label on the variable speed drive disconnect.
 - Lock the disconnect in the open position.
- Disconnect all power including external control power that may be present before servicing the drive. WAIT 15 MINUTES to allow the DC bus capacitors to discharge. Then follow the DC bus voltage measurement procedure given in the Installation Manual to verify that the DC voltage is less than 45 VDC. The drive LEDs are not accurate indicators of the absence of DC bus voltage.

Failure to follow these instructions will result in death or serious injury.

WARNING

DAMAGED EQUIPMENT

Do not install or operate any drive or drive accessory that appears damaged. The relays, inputs, or outputs of a damaged drive may not operate in a normal manner, leading to unintended equipment operation.

Failure to follow this instruction can result in death, serious injury, or equipment damage.

WARNING

LOSS OF CONTROL

- The designer of any control scheme must consider the potential failure modes of control paths and, for certain critical control functions, provide a means to achieve a safe state during and after a path failure. Examples of critical control functions are emergency stop and overtravel stop.
- Separate or redundant control paths must be provided for critical control functions.
- System control paths may include communication links. Consideration must be given to the implications of unanticipated transmission delays or failures of the link.*
- Each implementation of an Altivar 71 Modbus TCP/IP Ethernet card must be individually and thoroughly tested for proper operation before being placed into service.

Failure to follow this instruction can result in death, serious injury, or equipment damage.

* For additional information, refer to NEMA ICS 1.1 (latest edition), "Safety Guidelines for the Application, Installation, and Maintenance of Solid State Control" and to NEMA ICS 7.1 (latest edition), "Safety Standards for Construction and Guide for Selection, Installation and Operation of Adjustable-Speed Drive Systems".

3. Documentation structure

The following Altivar 61 / 71 technical documents are available on the Web site www.schneider-electric.com and on the CDROM.

■ Installation Manual

This manual describes:

- How to assemble the drive.
- How to connect the drive.

■ Programming Manual

This manual describes:

- The functions.
- The parameters.
- How to use the drive display terminal (integrated display terminal and graphic display terminal).

■ Communication Parameters Manual

This manual describes:

- The drive parameters with specific information (addresses, formats, etc.) for use via a bus or communication network.
- The operating modes specific to communication (state chart).
- The interaction between communication and local control.

■ Modbus[®], CANopen[®], Ethernet[™], Profibus[®], INTERBUS, Uni-Telway, DeviceNet[™], Modbus[®] Plus, Fipio[™], etc., manuals.

These manuals describe:

- Connection to the bus or network.
- Configuration of the communication-specific parameters via the integrated display terminal or the graphic display terminal.
- Diagnostics.
- Software setup.
- The communication services specific to the protocol.

■ Altivar 58/58F Migration Manual

This manual describes the differences between the Altivar 71 and the Altivar 58/58F.

It explains how to replace an Altivar 58 or 58F, including how to replace drives communicating on a bus or network.

4. Introduction

4. 1. Presentation

The Ethernet card (catalog number VW3 A3 310d) is used to connect an Altivar 61 / 71 drive to an Ethernet network using the Modbus TCP/IP protocol and Transparent Ready services.

The VW3 A3 310d card is equipped with two shielded RJ45 Ethernet connector.

The accessories for connection to the Ethernet network must be ordered separately.

The data exchanges permit full drive functionality:

- Configuration
- Adjustment
- Control
- Monitoring
- Diagnostics

The standard Web server (English only) provides access to the following pages:

- Altivar Viewer
 - Data Viewer
 - Ethernet
 - Security
- Etc.

The standard Web server can be adapted or replaced by a customized server depending on the requirements of the application.

The graphic display terminal or the integrated display terminal can be used to access numerous functions for communication diagnostics.

4. 2. Notation

Drive terminal displays

The graphic display terminal menus are shown in square brackets.

Example: [1.9 COMMUNICATION].

The integrated 7-segment display terminal menus are shown in round brackets.

Example: (C D n -).

The parameter names displayed on the graphic display terminal are shown in square brackets.

Example: [Fallback speed].

The parameter codes displayed on the integrated 7-segment display terminal are shown in round brackets.

Example: (L F F).

Formats

Hexadecimal values are written as follows: 16#

Binary values are written as follows: 2#

5. Hardware setup

5. 1. Receipt

- Check that the card catalog number marked on the label is the same as that on the delivery note corresponding to the purchase order.
- Remove the option card from its packaging and check that it has not been damaged in transit.

⚠ CAUTION

STATIC SENSITIVE COMPONENTS

The Modbus TCP/IP Ethernet card can be damaged by static electricity. Observe electrostatic precautions when handling and installing the card.

Failure to follow this instruction can result in equipment damage.

5. 2. Hardware description

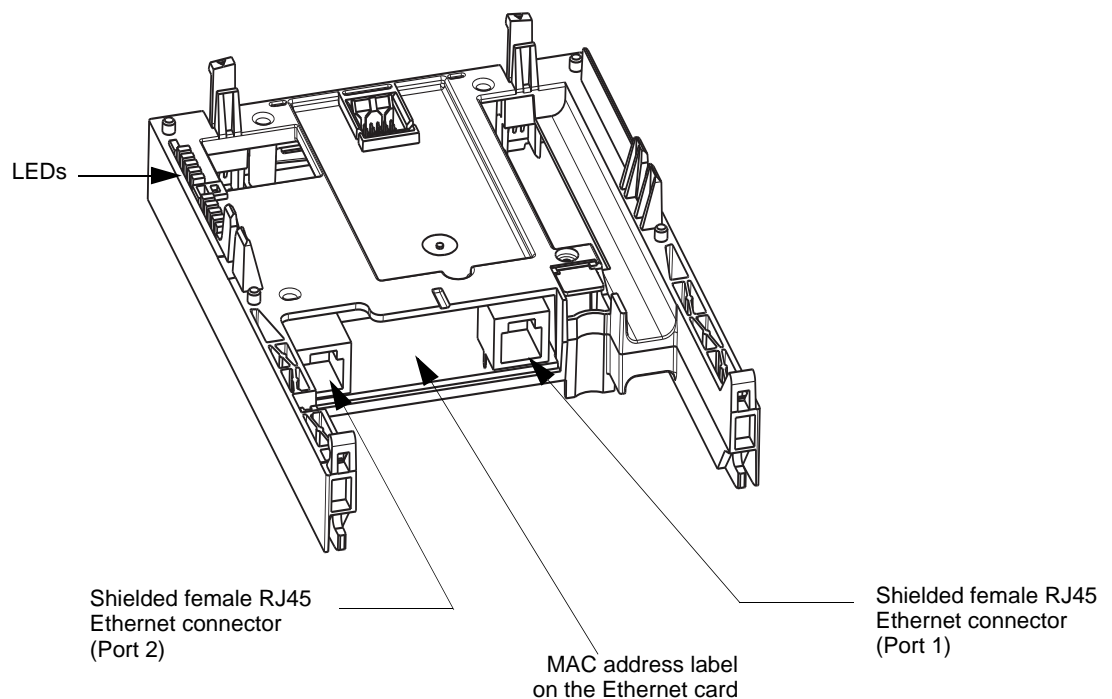

5. 3. Installing the card in the drive

See the Installation Manual.

6. Connecting to the Ethernet network

6. 1. Card RJ45 connector pinout

The Ethernet card is equipped with a shielded RJ45 connector. The shielding is connected to the drive ground. Use an STP (shielded twisted pair) Ethernet cable.

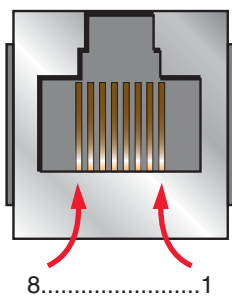

Pin	Signal
1	TD+
2	TD-
3	RD+
4	
5	
6	RD-
7	
8	

The transmission speed is detected automatically by the card (10 Mbps or 100 Mbps).

The card can operate in half duplex or full duplex mode, whether connected to a hub or a switch and regardless of the transmission speed (10 Mbps or 100 Mbps).

The card supports the ETHERNET 2 frame format (IEEE 802-3 not supported).

6. 2. Example of connection to an Ethernet network

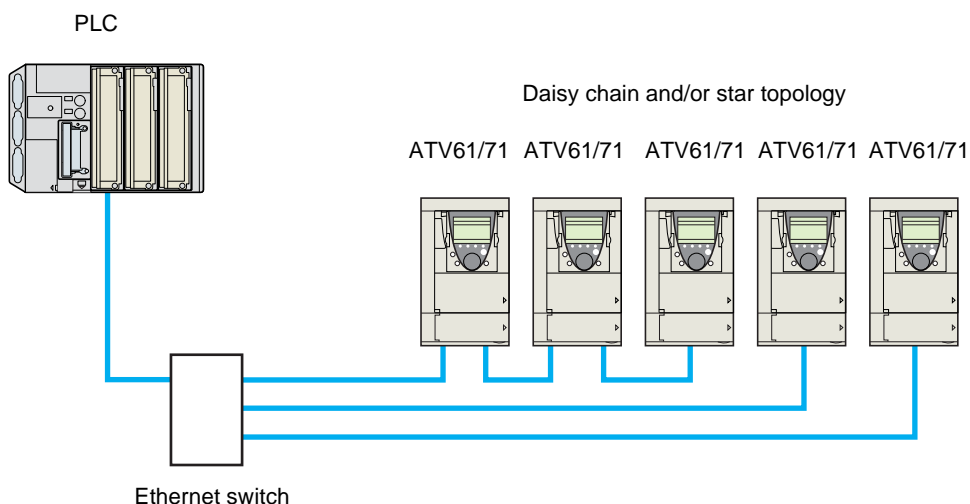

Note: When the topology is a daisy chain, if one drive is turned off, the drive(s) next the drive powered off trip in CNF fault. To keep the integrity of the Ethernet daisy chain network even if one or several drives are powered off, it is mandatory to add an external permanent 24V Dc supply for the drives control bloc.

6. Connecting to the Ethernet network

6. 3. Ethernet network connection elements

Please consult our catalog "Ethernet TCP/IP and the Web" (available on the Web site www.schneider-electric.com).

Connecting cables

Description	Use		Length m	Catalog number
	From	To		
Straight shielded twisted pair cables 2 RJ45 connectors	ATV71 (+ VW3 A3 310d card)	Hubs	2	490 NTW 000 02
		499 N●H 1●● 10	5	490 NTW 000 05
		Switches	12	490 NTW 000 12
		499 N●S 171 00	40	490 NTW 000 40
			80	490 NTW 000 80

Hubs and switches

Description	Characteristics	Catalog number
Hubs	4 × 10BASE-T ports	499 NEH 104 10
	4 × 100BASE-TX ports	499 NEH 141 10
	3 × 10BASE-T ports 2 × 10BASE-FL ports, multimode fiber, ST (BFOC) connectors	499 NOH 105 10
Switches	5 × 10BASE-T/100BASE-TX ports Unmanageable basic	499 NES 251 00
	4 × 10BASE-T/100BASE-TX ports 1 × 100BASE-FX port, multimode fiber, SC connectors Unmanageable	499 NMS 251 01
	3 × 10BASE-T/100BASE-TX ports 2 × 100BASE-FX port, multimode fiber, SC connectors Unmanageable	499 NMS 251 02
	4 × 10BASE-T/100BASE-TX ports 1 × 100BASE-FX port, monomode fiber, SC connectors Unmanageable	499 NSS 251 01
	3 × 10BASE-T/100BASE-TX ports 2 × 100BASE-FX port, monomode fiber, SC connectors Unmanageable	499 NSS 251 02
	8 × 10BASE-T/100BASE-TX ports Unmanageable	499 NES 181 00
	7 × 10BASE-T/100BASE-TX ports Manageable	499 NES 271 00
	5 × 10BASE-T/100BASE-TX ports 2 × 100BASE-FX port, multimode fiber, SC connectors Manageable	499 NOS 271 00
	5 × 10BASE-T/100BASE-TX ports 2 × 100BASE-FX port, monomode fiber, SC connectors Manageable	499 NSS 271 00

7. Ethernet menu

7. 1. Access to Ethernet menu via graphic display terminal

The [ETHERNET] submenu is used to configure and display the Ethernet card parameters and can be accessed via the [1.9 - COMMUNICATION] menu.

If you are using the FDR (Faulty Device Replacement) function, you must also configure the device name in the [7. DISPLAY CONFIG.] menu, [7.1 USER PARAMETERS] submenu, [DEVICE NAME] submenu.

This menu is only accessible in expert mode: In the [2 ACCESS LEVEL] (L A C -) menu, set the level to [expert] (E P r).

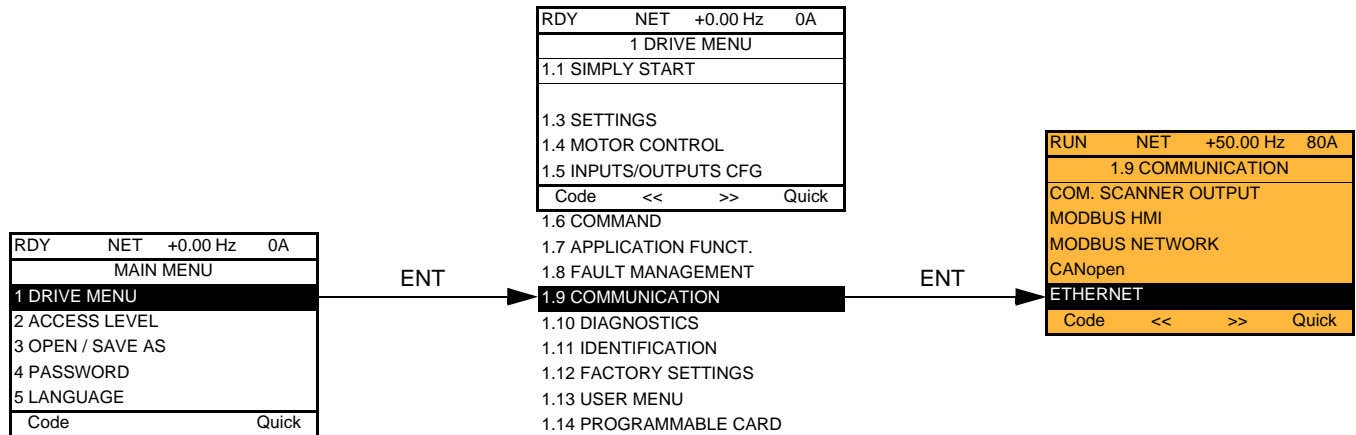

7. 2. Access to Ethernet menu via the integrated display terminal

The (E L H -) submenu is used to configure and display the Ethernet card parameters. It can be accessed via the (C O N -) menu.

Note: The device name required for the FDR (Faulty Device Replacement) function cannot be configured via the integrated display terminal.

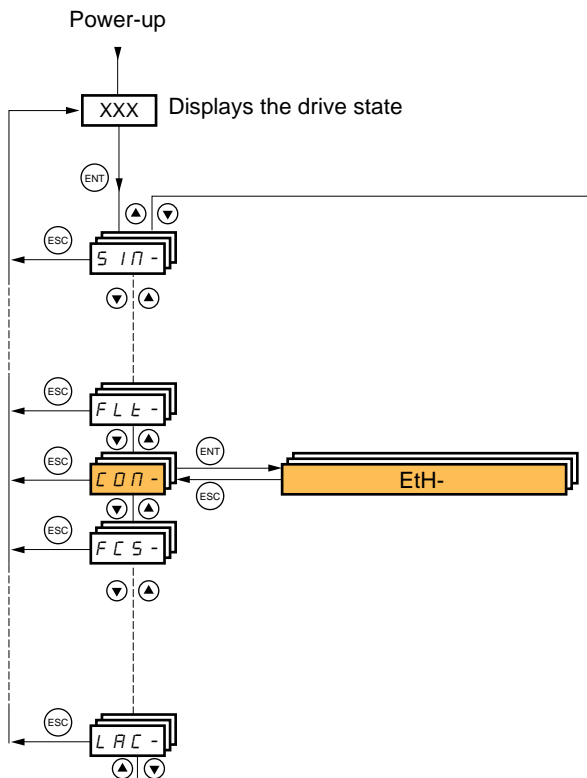

7. Ethernet menu

7. 3. Ethernet menu parameters

Code	Description
(bdr)	<p><input type="checkbox"/> [Bit rate] Transmission speed detected on the network by the Ethernet card</p> <p>Type: Display (read-only)</p> <p>Possible values: [0 Mbps] (0n): Indeterminate speed (before automatic detection of the Ethernet network speed) [10 Mbps] (10n): 10 Mbps [100 Mbps] (100n): 100 Mbps</p> <p>Default value: [0 Mbps] (0n)</p>
(PRn-)	<p>■ [DEVICE NAME]</p> <p>Device name used by FDR service. Accessible with an ATV71 from V1.2 and a ATV61 from V1.3 version. Use the navigation selector button to increment the character (alphabetical order) and << and >> (F2 and F3) to switch to the next or previous character respectively. Use F1 to change to ABC, abc, 123, *[-.</p> <p>Type: Configuration (read and write) Display (read-only)</p> <p>Possible values: 16 characters on 1 or 2 lines.</p> <p>Default value: [0]</p>
(IPC-)	<p>■ [IP card]</p>
(IPC1) (IPC2) (IPC3) (IPC4)	<p><input type="checkbox"/> [139.160.069.241] (139)(160)(069)(241) Ethernet card IP address</p> <p>Type: Configuration (read and write) Display (read-only) if the address has been supplied by a BOOTP or DHCP server</p> <p>Possible values: <ul style="list-style-type: none"> • 0 to 255 for each of fields IPC1, IPC2, IPC3 and IPC4. • If the value is [0.0.0.0] (0)(0)(0)(0), the Ethernet card waits for an address from a BOOTP or DHCP server. <p>Note: If you enter a value other than [0.0.0.0] (0)(0)(0)(0), dynamic addressing by a BOOTP or DHCP server is disabled. Note: After dynamic addressing by a BOOTP or DHCP server, the value [0.0.0.0] (0)(0)(0)(0) is replaced by the address supplied.</p> <p>Default value: [0.0.0.0] (0)(0)(0)(0)</p> </p>
(IPn-)	<p>■ [IP Mask]</p>
(IPn1) (IPn2) (IPn3) (IPn4)	<p><input type="checkbox"/> [255.255.254.0] (255)(255)(254)(0) Subnet mask</p> <p>Type: Configuration (read and write) Display (read-only) if the address has been supplied by a BOOTP or DHCP server</p> <p>Possible values: <ul style="list-style-type: none"> • 0 to 255 for each of fields IPM1, IPM2, IPM3 and IPM4. • If the value of the IP address [IP card] is [0.0.0.0] (0)(0)(0)(0), the Ethernet card waits for a mask from a BOOTP or DHCP server. <p>Note: After dynamic addressing by a BOOTP or DHCP server, the current value is replaced by the address supplied.</p> <p>Default value: [0.0.0.0] (0)(0)(0)(0)</p> </p>
(IPG-)	<p>■ [IP Gate]</p>
(IPG1) (IPG2) (IPG3) (IPG4)	<p><input type="checkbox"/> [0.0.0.0] (0)(0)(0)(0) Gateway IP address</p> <p>Type: Configuration (read and write) Display (read-only) if the address has been supplied by a BOOTP or DHCP server</p> <p>Possible values: <ul style="list-style-type: none"> • 0 to 255 for each of fields IPG1, IPG2, IPG3 and IPG4. • If the value of the IP address [IP card] is [0.0.0.0] (0)(0)(0)(0), the Ethernet card waits for a mask from a BOOTP or DHCP server. <p>Note: After dynamic addressing by a BOOTP or DHCP server, the current value is replaced by the address supplied.</p> <p>Default value: [0.0.0.0] (0)(0)(0)(0)</p> </p>

7. Ethernet menu

Code	Description
(IPP -)	<h3>■ [IP Master]</h3>
(IPP 1) (IPP 2) (IPP 3) (IPP 4)	<input type="checkbox"/> [0.0.0.0] (0) (0) (0) (0) IP address of the device that retains control Type: Configuration (read and write) Display (read-only) if the address is supplied by a DHCP server Possible values: <ul style="list-style-type: none"> • 0 to 255 for each of fields IPP1, IPP2, IPP3 and IPP4. • If the value is [0.0.0.0] (0) (0) (0) (0), writing of the control word (C P d) is accepted by the Ethernet card regardless of which device has sent it. • If the value is other than [0.0.0.0] (0) (0) (0) (0) only the device which has the IP address [IP Master] is authorized to write the control word (C P d). Note: This configuration also affects the type of communication monitoring. Default value: [0.0.0.0] (0) (0) (0) (0)
(IPF -)	<h3>■ [IP FDR]</h3>
(IPF 1) (IPF 2) (IPF 3) (IPF 4)	<input type="checkbox"/> [0.0.0.0] (0) (0) (0) (0) IP address of the FDR server Type: Display (read-only) Possible values: <ul style="list-style-type: none"> • 0 to 255 for each of fields IPF1, IPF2, IPF3 and IPF4. • If the value is [0.0.0.0] (0) (0) (0) (0), there is no server. Default value: [0.0.0.0] (0) (0) (0) (0)
(ISA)	<input type="checkbox"/> [IO Scan.activ.] Enable IO Scanner Type: Configuration (read and write) Possible values: <ul style="list-style-type: none"> • [No] (n D): IO Scanner disabled. • [Yes] (Y E S): IO Scanner enabled. Default value: [Yes] (Y E S)
(E O U T)	<input type="checkbox"/> [time out] Ethernet communication monitoring time out Type: Configuration (read and write) Possible values: <ul style="list-style-type: none"> • [0] (0): Monitoring disabled. • [0.5 s] (0 . 5) to [60.0 s] (6 0 . 0): Time out value (unit: 0.1 s). Default value: [2.0 s] (2 . 0)
(F d r U)	<input type="checkbox"/> [FDR validation] Enable FDR service Type: Configuration (read and write) Possible values: <ul style="list-style-type: none"> • [No] (n D): FDR service disabled. • [Yes] (Y E S): FDR service enabled. Default value: [Yes] (Y E S)
(L C F G)	<input type="checkbox"/> [FDR Local Config.] Selection of local or server configuration Type: Configuration (read and write) Possible values: <ul style="list-style-type: none"> • [No] (n D): The drive configuration is downloaded from an FDR server. • [Yes] (Y E S): The drive configuration is local and saved in a FDR server. Default value: [No] (n D)
(F d r F)	<input type="checkbox"/> [FDR Error Mgt.] Enable FDR fault management process Type: Configuration (read and write) Possible values: <p>In the event of a problem with the FDR file (missing or invalid):</p> <ul style="list-style-type: none"> • [No] (n D): The Ethernet card does not trigger an Ethernet fault (network management). • [Yes] (Y E S): The Ethernet card triggers a network management fault. Default value: [Yes] (Y E S)

7. Ethernet menu

Code	Description
(F d r A)	<p>□ [FDR Action]</p> <p>FDR service command</p> <p>Type: Command (read and write)</p> <p>Possible values:</p> <ul style="list-style-type: none"> • [IDLE] (I d L E): No command. • [SAVE] (S A V E): Command: save. • [REST] (r E S T): Command: download. • [DEL] (d E L): Command: delete. <p>The command remains displayed during the action then reverts to the value [IDLE] (I d L E).</p> <p>Default value: [IDLE] (I d L E)</p>
(F d r S)	<p>□ [FDR autosave]</p> <p>Enable periodic saving of the FDR service</p> <p>Type: Configuration (read and write)</p> <p>Possible values:</p> <ul style="list-style-type: none"> • [No] (n O): Automatic saving disabled. • [Yes] (Y E S): Automatic saving enabled. <p>Default value: [No] (n O)</p>
(F d r t)	<p>□ [FDR t.autosave]</p> <p>Interval for periodic saving of the FDR service</p> <p>Type: Configuration (read and write)</p> <p>Possible values:</p> <ul style="list-style-type: none"> • [2] (2) to [9999] (9 9 9 9): 2 min to 9999 min. <p>Default value: [10] (1 0)</p>
(F d r E)	<p>□ [FDR state]</p> <p>FDR service state</p> <p>Type: Display (read-only)</p> <p>Possible values:</p> <ul style="list-style-type: none"> • [IDLE] (I d L E): "Idle". • [INIT] (I N I T): Initialization. • [CONF] (C O N F): Configuration. • [RDY] (r d y): Ready. • [GET] (G E T): Download the current configuration. • [SET] (S E T): Save the current configuration. • [APP] (A P P): Write the FDR server configuration to the drive. • [OPE] (O P E): Operational. • [UCFG] (U C F G): Not configured. <p>Default value: [IDLE] (I d L E)</p>
(F d r d)	<p>□ [FDR Error Code]</p> <p>FDR service error code</p> <p>Type: Display (read-only)</p> <p>Possible values:</p> <ul style="list-style-type: none"> • [0] (0): No fault. • [2] (2): The FDR configuration file is not compatible with the drive type (example: the drive is not the same rating as that defined in the FDR file). • [3] (3): Error reading the FDR configuration file on the server. • [4] (4): Error writing the FDR configuration file to the server. • [7] (7): Time-out for receipt of the FDR configuration file from the server. • [9] (9): Duplication of IP address. • [12] (1 2): The FDR configuration file is missing. <p>Default value: [0] (0)</p>

8. Configuration

8. 1. List of functions to be configured

The table below gives the list of configuration functions and how they can be accessed:

Functions		Graphic display terminal	Integrated display terminal	PC-Software software workshop	Standard Web server
Entering the IP addresses		●	●	●	
FDR (Faulty Device Replacement)	Entering the device name	●		●	
	Configuration (time delay, etc.)	●	●	●	●
	Commands (save, etc.)	●	●		●
IO Scanning	Enable IO Scanner	●	●	●	●
	Configuring the IO Scanner variables			●	●
Reserving control (IP master)		●	●	●	●
Communication monitoring		●	●	●	●
Security of access to the standard Web server	Changing the "username"			●	
	Changing the "HTTP password"				●
	Changing the "Write password"			●	●

Configuration using the drive graphic display terminal or the integrated display terminal is explained in the "Configuration" section.

Configuration using the standard Web server is explained in the "Standard Web server" section.

For configuration using the PC-Software workshop, refer to the online help.

Note: The Ethernet card saves its configuration (IP address, mask, gateway, etc.) to the EEPROM each time the configuration is modified.

Note: For performance reasons, we do not recommend using the drive communication scanner. It is better to use the Ethernet IO Scanner.

Note: Configuration must be performed with the motor stopped.

8. Configuration

8. 2. Configuring IP addresses

■ Assigning IP addresses

The drive needs 3 IP addresses:

- The drive IP address.
- The subnet mask.
- The gateway IP address.

These IP addresses can be entered directly:

- Using the integrated display terminal.
- Using the graphic display terminal.
- Or using the PC-Software workshop.

They can be provided by:

- A BOOTP server (correspondence between the MAC address and the IP addresses).
- Or a DHCP server (correspondence between Device Name [DEVICE NAME] and the IP addresses).

If an IP address other than 0.0.0.0 has been entered using the display terminal or the PC-Software workshop, assignment using a server is disabled.

The BOOTP service is enabled:

- When no IP address other than 0.0.0.0 has been entered.
- And the FDR service has not been enabled ([FDR validation] parameter = [No] or a [DEVICE NAME] has not been entered).

The DHCP service is enabled:

- When no IP address other than 0.0.0.0 has been entered.
- And the FDR service has been enabled ([FDR validation] parameter = [Yes] and a [DEVICE NAME] has been entered).

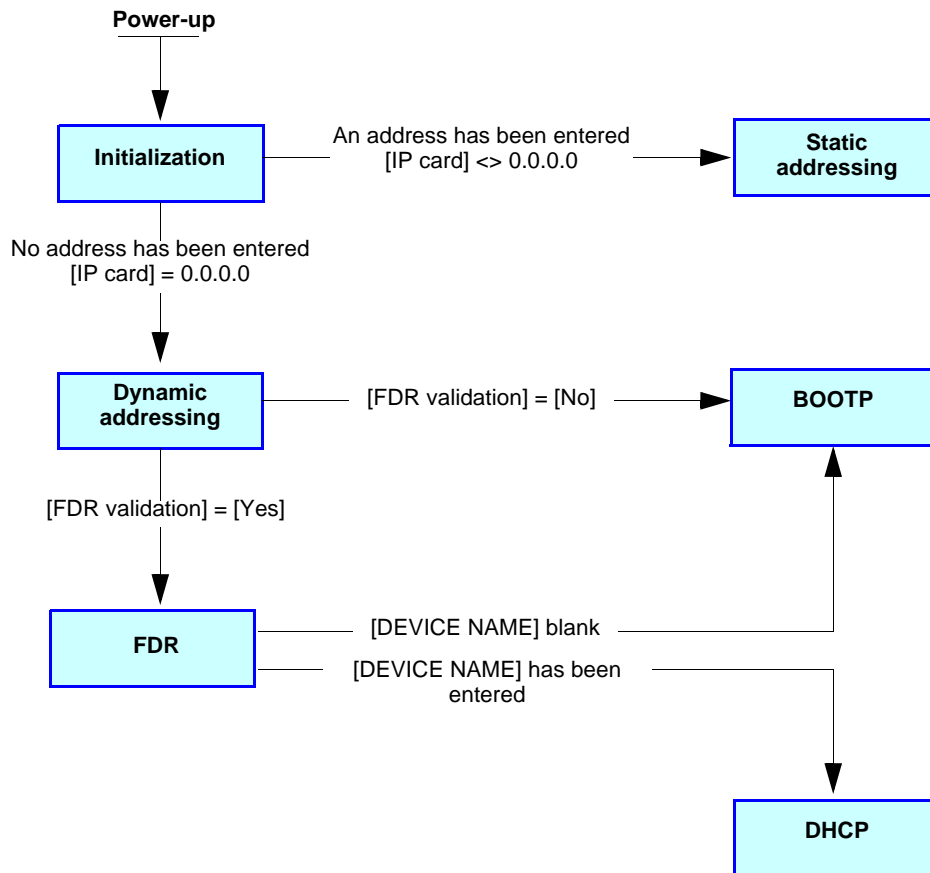

8. Configuration

■ Entering IP addresses in the terminal

In the [1.9 - COMMUNICATION] (C O N -) menu, [ETHERNET] (E t H -) submenu, enter the following IP addresses:

- [IP card] (I P C 1) (I P C 2) (I P C 3) (I P C 4).
- [IP Mask] (I P M 1) (I P M 2) (I P M 3) (I P M 4).
- [IP Gate] (I P G 1) (I P G 2) (I P G 3) (I P G 4).

Turn the drive off and then back on again (control voltage if a separate power supply is being used), otherwise the IP addresses are not taken into account.

Note: Before entry begins, the IP address displayed is the active IP address.

If this address is modified, the new IP address entered is displayed. This IP address will be effective the next time the drive is turned on.

■ Configuring BOOTP

The BOOTP service is used to assign IP addresses from the MAC address. The MAC address consisting of 6 hexadecimal digits (00-80-F4-80-xx-yy) must be entered in the BOOTP server. The MAC address appears on the label attached to the Ethernet card.

In the [1.9 - COMMUNICATION] (C O N -) menu, [ETHERNET] (E t H -) submenu:

- Leave the IP address [IP card] (I P C 1) (I P C 2) (I P C 3) (I P C 4) at the value [0.0.0.0] (0) (0) (0) (0).
- Do not enable the FDR service: [FDR validation] (F d r U) = [No] (n 0).

■ Configuring FDR

The FDR service (based on DHCP) is used to assign the IP addresses from the device name that must be entered in the drive and in the FDR server (DHCP).

In the [1.9 - COMMUNICATION] (C O N -) menu, [ETHERNET] (E t H -) submenu:

- Leave the IP address [IP card] (I P C 1) (I P C 2) (I P C 3) (I P C 4) at the value [0.0.0.0] (0) (0) (0) (0).
- Enable the FDR service: [FDR validation] (F d r U) = [Yes] (Y E S).

For the FDR function, select the drive configuration as either:

- Local: [FDR Local Config.] (L C F G) = [Yes] (Y E S).
- Downloaded. In this case, it is essential to consult the "FDR Service" section.

Enter the device name, [DEVICE NAME], in the [7. DISPLAY CONFIG.] menu, [7.1 USER PARAMETERS] submenu.

This menu is only accessible in expert mode: In the [2 ACCESS LEVEL] (L A C -) menu, set the level to [expert] (E P r).

Turn the drive off and then back on again (control voltage if a separate power supply is being used), otherwise the device name is not taken into account.

Note: The FDR function cannot be fully configured using the integrated display terminal as it does not provide access to the device name.

8. Configuration

8.3. Reserving control

It is strongly recommended that control should be reserved for a single master device.

If control were not to be reserved for a master device (for example a PLC):

- Any other Modbus TCP Ethernet client could send unwanted commands.
- Other clients could use the 8 available TCP connections and prevent the master from having control.

WARNING

IP MASTER NOT SPECIFIED

Use the **[IP MASTER] (I P P)** menu option to configure a network master device. If a valid IP address for a master device is not specified using this option, other Ethernet clients can saturate the TCP connections or send incorrect commands leading to unintended equipment operation.

Failure to follow this instruction can result in death, serious injury, or equipment damage.

To configure this reservation, enter an IP address other than **[0.0.0.0] (0) (0) (0) (0)** in the **[1.9 COMMUNICATION] (C O M -)** menu, **[ETHERNET] (E T H -)** submenu, **[IP Master]** submenu.

- If control has been reserved:
 - Only the control word (CMd) written by the master with control will be accepted via IO Scanning or via Modbus TCP messaging. 2 TCP connections are reserved for this device. In this way, you avoid other TCP clients using all the available connections (8 maximum) and the control master therefore no longer being able to access the drive Modbus TCP server.
 - Other parameters written from other IP addresses are accepted (for example, adjustments or writing a setpoint). When control has been reserved and another device attempts to write the control word **(C P d)**:
 - via IO Scanning: The Modbus TCP connection for this client is immediately reinitialized.
 - via Modbus TCP messaging: Control is denied.
- If control has not been reserved (**[IP Master] = [0.0.0.0] (0) (0) (0) (0)**), control can come from any IP address.

8.4. Configuring IO Scanning

Refer to the "IO Scanning Service" section.

The drive IO Scanning service can be enabled or disabled in the **[1.9 - COMMUNICATION] (C O M -)** menu, **[ETHERNET] (E T H -)** submenu via parameter **[IO Scan.activ.] (I O S A)**.

It is not possible to modify the assignment of the IO Scanning periodic variables using the display terminal (integrated or graphic).

To configure IO Scanning, use the standard Web server or the PC-Software workshop.

8. Configuration

8.5. Configuring the control

Numerous configurations are possible. For more information, refer to the Programming Manual and the Communication parameters Manual.

The following configurations are just some of the possibilities available.

■ Control via Ethernet in I/O profile

The command and setpoint come from Ethernet.
The command is in I/O profile.

Configure the following parameters:

Parameter	Value	Comment
Profile	I/O profile	The run command is simply obtained by bit 0 of the control word.
Setpoint 1 configuration	Network card	The setpoint comes from Ethernet.
Command 1 configuration	Network card	The command comes from Ethernet.

Configuration via the graphic display terminal or the integrated display terminal:

Menu	Parameter	Value
[1.6 - COMMAND] (C E L -)	[Profile] (C H C F)	[I/O profile] (I D)
	[Ref.1 channel] (F r I)	[Com. card] (n E E)
	[Cmd channel 1] (C d I)	[Com. opt card] (n E E)

■ Control via Ethernet or the terminals in I/O profile

Both the command and setpoint come from Ethernet or the terminals. Input LI5 at the terminals is used to switch between Ethernet and the terminals.

The command is in I/O profile.

Configure the following parameters:

Parameter	Value	Comment
Profile	I/O profile	The run command is simply obtained by bit 0 of the control word.
Setpoint 1 configuration	Network card	Setpoint 1 comes from Ethernet.
Setpoint 1B configuration	Analog input 1 on the terminals	Setpoint 1B comes from input AI1 on the terminals.
Setpoint switching	Input LI5	Input LI5 switches the setpoint (1 ↔ 1B).
Command 1 configuration	Network card	Command 1 comes from Ethernet.
Command 2 configuration	Terminals	Command 2 comes from the terminals.
Command switching	Input LI5	Input LI5 switches the command.

Note: Setpoint 1B is connected to the functions (summing, PID, etc.), which remain active, even after switching.

Configuration via the graphic display terminal or the integrated display terminal:

Menu	Parameter	Value
[1.6 - COMMAND] (C E L -)	[Profile] (C H C F)	[I/O profile] (I D)
	[Ref.1 channel] (F r I)	[Com. card] (n E E)
	[Cmd channel 1] (C d I)	[Com. card] (n E E)
	[Cmd channel 2] (C d 2)	[Terminals] (E E r)
	[Cmd switching] (C E 5)	[LI5] (L I 5)
[1.7 APPLICATION FUNCT.] (F U n -) [REFERENCE SWITCH.]	[Ref.1B channel] (F r I b)	[Ref. AI1] (A I I)
	[Ref 1B switching] (r C b)	[LI5] (L I 5)

8. Configuration

■ Control via Ethernet in Drivecom profile

The command and setpoint come from Ethernet.
The command is in Drivecom profile.

Configure the following parameters:

Parameter	Value	Comment
Profile	Drivecom profile not separate	The run commands are in Drivecom profile, the command and the setpoint come from the same channel.
Setpoint 1 configuration	Network card	The command comes from Ethernet.

Configuration via the graphic display terminal or the integrated display terminal:

Menu	Parameter	Value
[1.6 - COMMAND] (C E L -)	[Profile] (C H C F)	[Not separ.] (S I N) (factory setting)
	[Ref.1 channel] (F r 1)	[Com. card] (n E E)

■ Control via Ethernet or the terminals in Drivecom profile

Both the command and setpoint come from Ethernet or the terminals. Input LI5 at the terminals is used to switch between Ethernet and the terminals.

The command is in Drivecom profile.

Configure the following parameters:

Parameter	Value	Comment
Profile	Drivecom profile not separate	The run commands are in Drivecom profile, the command and the setpoint come from the same channel.
Setpoint 1 configuration	Network card	Setpoint 1 comes from Ethernet.
Setpoint 2 configuration	Analog input 1 on the terminals	Setpoint 2 comes from input AI1 on the terminals.
Setpoint switching	Input LI5	Input LI5 switches the setpoint (1 ↔ 2) and the command.

Note: Setpoint 2 is directly connected to the drive setpoint limit. If switching is performed, the functions that affect the setpoint (summing, PID, etc.) are disabled.

Configuration via the graphic display terminal or the integrated display terminal:

Menu	Parameter	Value
[1.6 - COMMAND] (C E L -)	[Profile] (C H C F)	[Not separ.] (S I N)
	[Ref.1 channel] (F r 1)	[Com. card] (n E E)
	[Ref.2 chan] (F r 2)	[Ref. AI1] (R I I)
	[Ref. 2 switching] (r F C)	[LI5] (L I 5)

8. Configuration

■ Command in Drivecom profile via Ethernet and setpoint switching at the terminals

The command comes from Ethernet.

The setpoint comes either from Ethernet or from the terminals. Input LI5 at the terminals is used to switch the setpoint between Ethernet and the terminals.

The command is in Drivecom profile.

Configure the following parameters:

Parameter	Value	Comment
Profile	Drivecom profile separate	The run commands are in Drivecom profile, the command and the setpoint can come from different channels.
Setpoint 1 configuration	Network card	Setpoint 1 comes from Ethernet.
Setpoint 1B configuration	Analog input 1 on the terminals	Setpoint 1B comes from input AI1 on the terminals.
Setpoint switching	Input LI5	Input LI5 switches the setpoint (1 ↔ 1B).
Command 1 configuration	Network card	Command 1 comes from Ethernet.
Command switching	Channel 1	Channel 1 is the command channel.

Note: Setpoint 1B is connected to the functions (summing, PID, etc.), which remain active, even after switching.

Configuration via the graphic display terminal or the integrated display terminal:

Menu	Parameter	Value
[1.6 - COMMAND] (C L L -)	[Profile] (C H C F)	[Separate] (S E P)
	[Ref.1 channel] (F r 1)	[Com. card] (n E t)
	[Cmd channel 1] (C d 1)	[Com. card] (n E t)
	[Cmd switching] (C C 5)	[Ch1 active] (C d 1)
[1.7 APPLICATION FUNCT.] (F U n -) [REFERENCE SWITCH.]	[Ref.1B channel] (F r 1 b)	[Ref. AI1] (A I 1)
	[Ref 1B switching] (r C b)	[LI5] (L I 5)

8. Configuration

8. 6. Configuring the fault management

■ Communication monitoring

The Ethernet card can detect 2 types of fault:

- Network management faults (server missing, duplication of IP address, etc.).
- Communication faults (time out on the master traffic, etc.).

The associated information is:

	Ethernet fault type	
	Network management	Communication
Associated drive fault	Code: [External fault com.] (E P F 2)	Code: [Com. network] (C n F)
Configuring the communication fault	Parameter: [FDR Error Mgt.] (F d r F) Menu: [1.9 COMMUNICATION] (C 0 0 -) Submenu: [ETHERNET] (E L H -)	Parameter: [time Out] (L 0 U L) Menu: [1.9 COMMUNICATION] (C 0 0 -) Submenu: [ETHERNET] (E L H -)
Configuring the drive's response	Parameter: [External fault mgt] (E P L) Menu: [1.8 FAULT MANAGEMENT] (F L L -) Submenu: [EXTERNAL FAULT] (E L F -)	Parameter: [COM. fault mgt] (C L L) Menu: [1.8 FAULT MANAGEMENT] (F L L -) Submenu: [COM. FAULT MANAGEMENT] (C L L -)

■ Network management fault

The IP address duplication management fault cannot be configured.

If the FDR (Faulty Device Replacement) service has been configured, the FDR fault can be disabled via the [FDR Error Mgt.] (F d r F) parameter, which can be accessed via the [1.9 COMMUNICATION] (C 0 0 -) menu, [ETHERNET] (E L H -) submenu.

In factory settings mode, a network management fault will trigger a resettable drive fault [External fault com.] (E P F 2) and initiate a freewheel stop.

■ Communication fault

It is strongly recommended that control should be reserved for a single master device.

Monitoring begins when the first control word is received.

Even if the command channel is not the network, a write access on the CMD word is necessary to activate the monitoring of the network.

⚠ WARNING

IP MASTER NOT SPECIFIED

Use the [IP MASTER] (I P P) menu option to configure a network master device. If a valid IP address for a master device is not specified using this option, other Ethernet clients can saturate the TCP connections or send incorrect commands leading to unintended equipment operation.

Failure to follow this instruction can result in death, serious injury, or equipment damage.

- If control has been reserved:
A communication fault is triggered if the Ethernet card does not receive a Modbus TCP request within a predefined period of time (time out).
Any type of Modbus request from the master device [IP Master] is taken into account (write operation, read operation, etc.).
- If control has not been reserved:
A communication fault is triggered if the Ethernet card does not receive a control word write request (C n d) within a predefined period of time (time out).
Receipt of the command (C n d) is taken into account regardless of the sender's IP address.

The "time out" can be set to between 0.5 and 60 s via the graphic display terminal or integrated display terminal in the [1.9 COMMUNICATION] (C 0 0 -) menu, [ETHERNET] (E L H -) submenu via the [time Out] (L 0 U L) parameter. The default value is 2 s.

In factory settings mode, if Ethernet is involved in the command or setpoint, a communication fault will trigger a resettable drive fault [Com. network] (C n F) and initiate a freewheel stop.

8. Configuration

■ Drive response

The drive response to an Ethernet fault can be configured via the graphic display terminal or the integrated display terminal, from the [1.8 FAULT MANAGEMENT] (F L E -) menu:

For communication faults
in the [COM. FAULT MANAGEMENT] (C L L -) submenu
via parameter [COM. fault mgt] (C L L)

RDY	NET	+0.00Hz	0A
COM. FAULT MANAGEMENT <input type="checkbox"/>			
Network fault mgt		:	Freewheel
CANopen fault mgt		:	Freewheel
Modbus fault mgt		:	Freewheel
Code		Quick	<input type="checkbox"/>

For network management faults
in the [EXTERNAL FAULT] (E L F -) submenu
via the [External fault mgt] (E P L) parameter

RDY	NET	+0.00Hz	0A
EXTERNAL FAULT			
External fault mgt		:	Freewheel
Code		Quick	<input type="checkbox"/>

The values of parameters: [COM. fault mgt] (C L L) that will trigger a drive fault [Com. network] (C n F) and [External fault mgt] (E P L) that will trigger a drive fault [External fault com.] (E P F 2) are:

[Freewheel] (Y E S): Freewheel stop (factory setting).

[Ramp stop] (r P P): Stop on ramp.

[Fast stop] (F S E): Fast stop.

[DC injection] (d C I): DC injection stop.

The values of parameters [COM. fault mgt] (C L L) and [External fault management] (E P L) which will not trigger a drive fault are:

[Ignore] (n D): Fault ignored.

[Per STT] (S E E): Stop according to configuration of [Stop type] (S E E).

[fallback spd] (L F F): Change to fallback speed, maintained as long as the fault persists and the run command has not been removed.

[Spd maint.] (r L S): The drive maintains the speed at the time the fault occurred, as long as the fault persists and the run command has not been removed.

The fallback speed can be configured in the [1.8 - FAULT MANAGEMENT] (F L E -) menu via the [Fallback speed] (L L F) parameter.

8. Configuration

8.7. Configuring monitored parameters

It is possible to select up to 4 parameters to display their values in the [1.2 - MONITORING] menu on the graphic display terminal.

The selection is made via the [6 - MONITORING CONFIG.] menu, [6.3 - COM. MAP CONFIG.] submenu.

Each parameter in the range [Address 1 select.] ... [Address 4 select.] is used to select the parameter logic address. Select an address of zero to disable the function.

In the example given here, the monitored words are:

- Parameter 1 = Motor current (LCR): logic address 3204; signed decimal format.
- Parameter 2 = Motor torque (OTR): logic address 3205; signed decimal format.
- Parameter 3 = Last fault occurred (LFT): logic address 7121; hexadecimal format.
- Disabled parameter: address 0; default format: hexadecimal format.

RDY	NET	+0.00Hz	0A
6.3 COM. MAP CONFIG.			<input type="checkbox"/>
Word 1 add. select.	:		3204
Format word 1	:		Signed
Word 2 add. select.	:		3205
Format word 2	:		Signed
Word 3 add. select.	:		7121
Code		Quick	<input checked="" type="checkbox"/>
Format word 33	:		Hex
Word 4 add. select.	:		0
Format word 4	:		Hex

One of the three display formats below can be assigned to each monitored word:

Format	Range	Terminal display
Hexadecimal	0000 ... FFFF	[Hex]
Signed decimal	-32,767 ... 32,767	[Signed]
Unsigned decimal	0 ... 65,535	[Unsigned]

9. Diagnostics

9. 1. Signalling LEDs

The VW3 A3 310d Ethernet card features 5 LEDs, which are visible through the Altivar 61 / 71 cover.

1.1
1.2
1.3
1.4
1.5

2.1 **Port 1 activity**
2.2 **Port 2 activity**
2.3 **Link status**
2.4 **NS "Network status"**
2.5 **MS "Module status"**

The 2 first LEDs are respectively dedicated to each Ethernet port.
The third LED is relative to the IP level.
The 2 last LEDs are specific to EtherNet/IP and CIP communication protocol.

LED	Color/ state	Description
2.1	Off	No link
	Flashing Green/yellow	Power up testing.
	Green ON	Link at 100 Mbps.
	Yellow ON	Link at 10 Mbps.
	Green BLINK	Activity at 100 Mbps.
	Yellow BLINK	Activity at 10 Mbps.
2.2	Off	No link
	Flashing Green/yellow	Power up testing.
	Green ON	Link at 100 Mbps.
	Yellow ON	Link at 10 Mbps.
	Green BLINK	Activity at 100 Mbps.
	Yellow BLINK	Activity at 10 Mbps.
2.3	Off	Physical connections unplugged - No IP address obtained
	Flashing Green/red	Power up testing.
	Green ON	At least one port is connected and an IP address has been obtained.
	Green flashing 3 times	All ports are unplugged, but the card has an IP address.
	Green flashing 4 times	Error: Duplicated IP address (1)
	Green flashing 5 times	The card is performing a BOOTP or DHCP sequence
2.4 "NS"	Off	The device does not have an IP address or powered off.
	Flashing Green/red	Power up testing.
	Green ON	The device has at least one established Modbus connection (even to the Message Router).
	Green flashing	The device has not established Modbus connections, but has obtained an IP address.
2.5 "MS"	Off	No power is supplied to the device
	Flashing Green/red	Power Up testing.
	Green ON	The device is ready.
	Green flashing	The device is not ready (waiting for cable connection, ...).
	Red flashing	The device has detected a [Network fault] (ENF).
	Red ON	The device has detected a [internal com. link] (ILF) fault.

9. Diagnostics

9. 2. Available information

In addition to the LEDs, the table below summarizes the diagnostic information available by various means.

Functions	Graphic display terminal	Integrated display terminal	PC-Software workshop	Standard Web server
Control-signal diagnostics <ul style="list-style-type: none"> • Control word • Setpoint • Active channel • Etc. 	●	●	●	●
Communication diagnostics <ul style="list-style-type: none"> • Transmission counter • Reception counter • Collision counter • Etc. 			●	●

9. 3. Monitoring the control

On the graphic display terminal only, the [1.2 - MONITORING] menu, [COMMUNICATION MAP] submenu can be used to display control-signal diagnostic information between the drive and the Ethernet PLC:

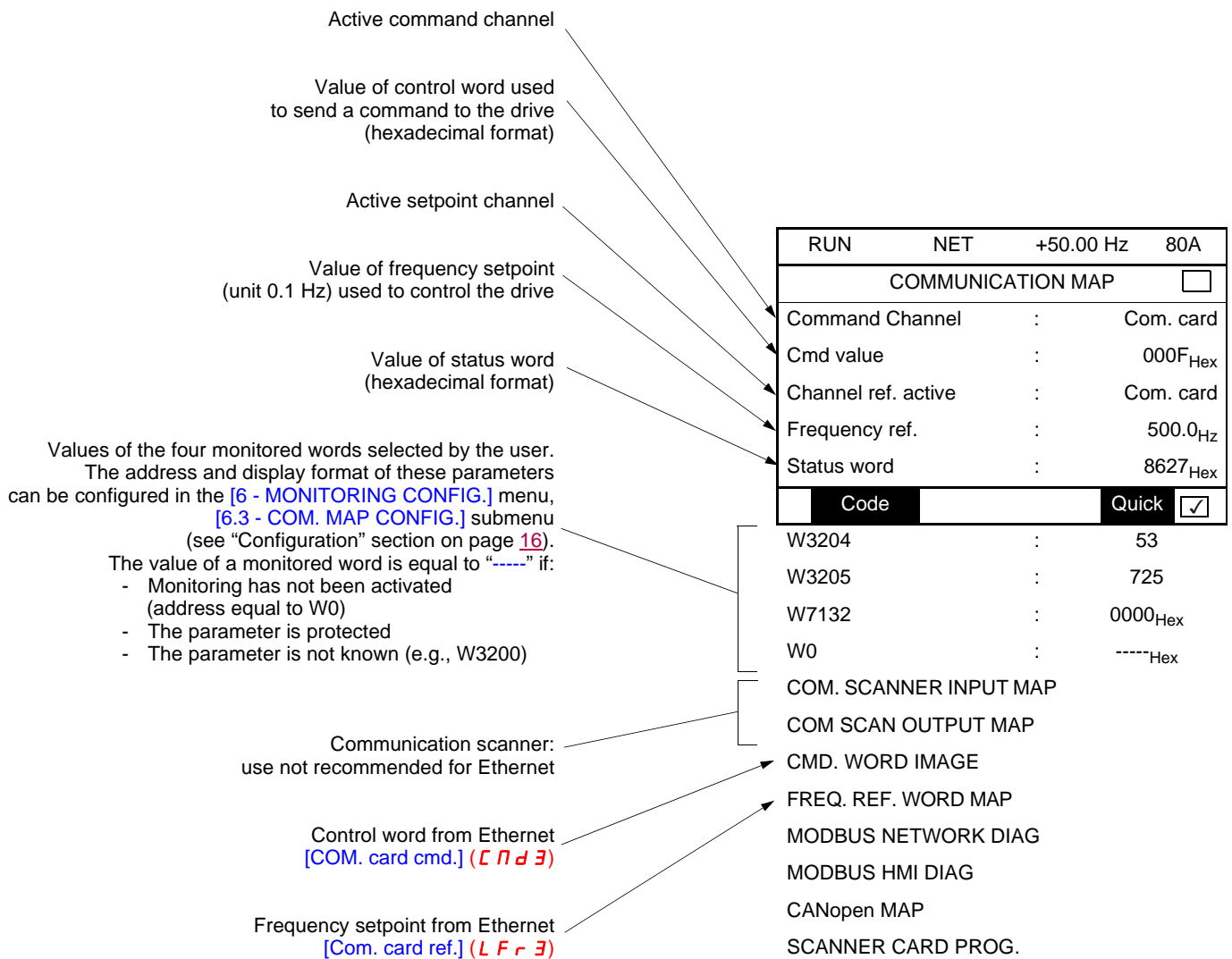

9. Diagnostics

9. 4. Troubleshooting the communication fault

■ Communication monitoring

Ethernet faults are indicated by the red FLT LED on the Ethernet card.

The Ethernet card can detect 2 types of fault:

- Network management faults (server missing, duplication of IP address, etc.).
- Communication faults (time out on the master traffic, etc.).

In factory settings mode, a network management fault will trigger a resettable drive fault [\[External fault com.\] \(EPF2\)](#) and initiate a freewheel stop.

In factory settings mode, if Ethernet is involved in the command or setpoint, a communication fault will trigger a resettable drive fault [\[Com. network\] \(CnF\)](#) and initiate a freewheel stop.

The drive's response in the event of an Ethernet communication fault can be changed (see the Configuration section).

- Drive fault [\[Com. network\] \(CnF\)](#) or [\[External fault com.\] \(EPF2\)](#) (freewheel stop, stop on ramp, fast stop or DC injection braking stop).
- No drive fault (stop, maintain, fallback).

The associated information is:

	Ethernet communication fault type	
	Network management	Communication
Associated drive fault	Code: [External fault com.] (EPF2)	Code: [Com. network] (CnF)
Extended fault code	[FDR fault] (Fdrd) Menu: [1.9 COMMUNICATION] (CDN-) Submenu: [ETHERNET] (ETH-)	[Network fault] (CnF) Menu: [1.10 DIAGNOSTICS] (dGt-) Submenu: [MORE FAULT INFO] (AFI-)

Parameter [\[Network fault\] \(CnF\)](#) is used to obtain more detailed information about the origin of the last fault [\[Com. network\] \(CnF\)](#). It can be accessed on the graphic display terminal only, in the [\[1.10 DIAGNOSTICS\] \(dGt-\)](#) menu, [\[MORE FAULT INFO\] \(AFI-\)](#) submenu.

Value	Description of the values of the [Network fault] (CnF) parameter
0	No fault
1	Modbus TCP time out
10	Network overload
11	Loss of Ethernet carrier

The [\[FDR fault\] \(Fdrd\)](#) Ethernet fault parameter is used to obtain more detailed information about the origin of the last fault [\[External fault com.\] \(EPF2\)](#). It can be accessed on the graphic display terminal only, in the [\[1.9 COMMUNICATION\] \(CDN-\)](#) menu, [\[ETHERNET\] \(ETH-\)](#) submenu.

Value	Description of the values of the [FDR fault] (Fdrd) Ethernet fault code parameter
0	No fault.
2	The FDR configuration file is not compatible with the drive type (example: the drive is not the correct rating).
3	Error reading the FDR configuration file on the server.
4	Error writing the FDR configuration file to the server.
7	Time-out for receipt of the FDR configuration file from the server.
9	Duplication of IP address (1).
12	FDR configuration file missing.
203	Inconsistent hardware configuration

- (1) The Ethernet card detects IP address duplication each time it connects to the network (power-up or connection to the network). If the card detects that another device is using the same IP address as itself, it abandons the use of the IP address and triggers a fault [\[External fault com.\] \(EPF2\)](#). If a device with an IP address identical to that of the drive is connected to the network during operation, the drive does not detect a fault (it is the new station that has to disconnect).

9. Diagnostics

9. 5. Troubleshooting the card fault

The [\[internal com. link\] \(ILF\)](#) fault appears when the following serious problems occur:

- Hardware fault on the Ethernet card.
- Dialog fault between the Ethernet card and the drive.

The drive's response in the event of an [\[internal com. link\] \(ILF\)](#) fault cannot be configured, and the drive trips with a freewheel stop. This fault cannot be reset.

Two diagnostic parameters are used to obtain more detailed information about the origin of the [\[internal com. link\] \(ILF\)](#) fault:

- [\[Internal link fault 1\] \(ILF1\)](#) if the fault has occurred on option card no. 1 (installed directly on the drive).
- [\[Internal link fault 2\] \(ILF2\)](#) if the fault has occurred on option card no. 2 (installed on option card no. 1).

The Ethernet card can be in position 1 or 2.

The [\[Internal link fault 1\] \(ILF1\)](#) and [\[Internal link fault 2\] \(ILF2\)](#) parameters can only be accessed on the graphic display terminal in the [\[1.10 DIAGNOSTICS\] \(dGt -\)](#) menu, [\[MORE FAULT INFO\] \(RF I-\)](#) submenu.

Value	Description of the values of the [Internal link fault 1] (ILF1) and [Internal link fault 2] (ILF2) parameters
0	No fault
1	Loss of internal communication with the drive
3	Error in the EEPROM checksum
101	Unknown card
102	Exchange problem on the drive internal bus
103	Time out on the drive internal bus (500 ms)

10. Software setup

10. 1. List of services supported

- Modbus TCP server, with the support of the “IO Scanning” periodic service.
- IP protocol (version 4).
- TCP and UDP protocol.
- HTTP server for configuring, adjusting and monitoring the drive.
- ICMP client for supporting certain IP services, such as the “ping” command.
- BOOTP client for assignment of an IP address by an address server.
- FTP protocol for file transfer.
- DHCP client for dynamic assignment of IP addresses by an address server.
- FDR service for replacement of a faulty device.
- SNMP protocol for network management.
- ARP protocol for detecting a competing IP address (IP address already in use).

10. 2. TCP connections

Number of simultaneous connections limited to 8 maximum (port 502).

The table below gives the number of connections consumed for each service:

Client	Service	Number of connections
Controller (PLC)	IO Scanning	1
	Modbus messaging	1
Web browser	“Home” page	0
	“Monitoring\Altivar Viewer” page	2
	“Monitoring\Data Viewer” page	1
	“Monitoring\Altivar chart” page	1
	“Diagnostics\Ethernet Statistics” page	1
	“Setup\Security\HTTP password” page	0
	“Setup\Security\Data write password” page	0
	“Setup\FDR agent” page	1
	“Setup\IO Scanner” page	1

Example:

If the “Altivar Viewer” page is viewed in two different windows of a Web browser, on the same PC, four connections are consumed. If the drive is controlled by a PLC, two connections are consumed by IO Scanning and Modbus messaging, so the total number of connections consumed is then six.

Two connections are still available, since the maximum number of simultaneous connections is eight.

If control is reserved for a device ([IP Master] (I P P -) configured), 2 connections are reserved for this device, even if it is not present on the network.

If the maximum number of connections has been exceeded, any new connection attempt will be rejected by the Ethernet card.

11. Modbus TCP server

11. 1. Modbus TCP frames

Modbus TCP frames consist of a header and a Modbus request.

Header format:

Byte	Description		Comments
0	Transaction identifier	high order	
1		low order	
2	Protocol identifier	high order	This identifier always equals 0.
3		low order	
4	Length of data	high order	Number of bytes in the Modbus request +1. The frame length is always less than 256 bytes, the value of the significant byte therefore equals 0.
5		low order	
6	Destination identifier (Unit ID)		
7	Modbus request function code		

The frame header returned by the Altivar 71 server is identical to that of the frame sent by the client.

11. 2. Drive Modbus servers

The destination identifier (Unit ID) is used to access 4 drive Modbus TCP servers:

Unit ID	Modbus TCP server	Accessible parameters
0	Variable speed drive	See the Altivar 71 Communication parameters Manual.
251, AMOC	Ethernet card	See the "Ethernet card parameters" section.
252, AMOA	Controller Inside card	2048 words (%MW0 to %MW2047).
255	IO Scanner	See the "IO Scanner" section.

11. Modbus TCP server

11. 3. Ethernet card parameters

Comments:

- Parameters on 2 words are double words (low order in address word n, high order in address word n+1).
- Parameters 60 019 to 60 043 and 60 066 to 60 068 can be accessed in both read and write mode. They can be reset using a write operation.
- The current IP addresses (60006 to 60017) are the ones displayed on the terminal. The EEPROM IP addresses (60075 to 60079) are the ones used by the card.

Address	Size (in words)	Description	Access	Possible values, comments
60 000	6	MAC address	R	00-80-F4-80-xx-yy 00: 60 000 80: 60 001 F4: 60 002 80: 60 003 xx: 60 004 yy: 60 005
60 006	4	Current value of IP Address [IP card] (<i>IP C -</i>)	R/W	IPC1.IPC2.IPC3.IPC4 IPC1: 60 006 IPC2: 60 007 IPC3: 60 008 IPC4: 60 009
60 010	4	Current value of Subnet mask [IP Mask] (<i>IP M -</i>)	R/W	IPM1.IPM2.IPM3.IPM4 IPM1: 60 010 IPM2: 60 011 IPM3: 60 012 IPM4: 60 013
60 014	4	Current value of Gateway Address [IP Gate] (<i>IP G -</i>)	R/W	IPG1.IPG2.IPG3.IPG4 IPG1: 60 014 IPG2: 60 015 IPG3: 60 016 IPG4: 60 017
60 018	1	Transmission speed [Bit rate] (<i>b d r</i>)	R	= 0: Speed not defined = 10: 10 Mbps = 100: 100 Mbps
60 019	2	OK transmission counter	R/W	
60 021	1	Store-and-forward transmission counter	R/W	
60 022	1	Late collision counter	R/W	
60 023	1	Buffer (Tx) error counter	R/W	
60 024	2	OK reception counter	R/W	
60 026	1	CRC error counter	R/W	
60 027	1	Frame error counter	R/W	
60 028	1	Buffer (Rx) error counter	R/W	
60 029	1	Collision counter	R/W	
60 030	1	Multiple collision counter	R/W	
60 031	1	OverRun counter	R/W	
60 032	2	Sent Modbus TCP message counter	R/W	IO Scanning messages not included
60 034	2	Received Modbus TCP message counter	R/W	IO Scanning messages not included
60 036	1	Modbus TCP message error counter	R/W	IO Scanning messages not included
60 037	2	Sent IO Scanning message counter	R/W	
60 039	2	Received IO Scanning message counter	R/W	
60 041	1	IO Scanning message error counter	R/W	
60 042	1	Active traffic (msg/s)	R/W	
60 043	1	Max. traffic (msg/s)	R/W	
60 044	1	Number of active TCP connections	R	8 maximum

11. Modbus TCP server

Address	Size (in words)	Description	Access	Possible values, comments
60 045	1	Communication monitoring time out [time out] (<i>t O U t</i>)	R/W	Unit: 0.1 s; min. = 5 (0.5 s); max. = 600 (60.0 s)
60 046	1	Drive type	R	= 2 ATV71
60 047	1	Reserved	R	= 0
60 048	1	Enable IO Scanner [IO Scan. activ.] (<i>I O S A</i>)	R/W	= 0 [No] (<i>n O</i>) : IO Scanning disabled. = 1 [Yes] (<i>Y E S</i>) : IO Scanning enabled.
60 049	1	Reserved	R	= 0
60 050	4	IP address of Master [IP Master] (<i>I P P -</i>)	R/W	IPP1.IPP2.IPP3.IPP4 IPP1 = 60 050 IPP2 = 60 051 IPP3 = 60 052 IPP4 = 60 053
60 054	4	IP address of DHCP-FDR server [IP FDR] (<i>I P F -</i>)	R	IPF1.IPF2.IPF3.IPF4 IPF1 = 60 054 IPF2 = 60 055 IPF3 = 60 056 IPF4 = 60 057
60 058	1	Enable FDR service [FDR validation] (<i>F d r U</i>)	R/W	0 = [No] (<i>n O</i>) : FDR service disabled 1 = [Yes] (<i>Y E S</i>) : FDR service enabled
60 059	1	Select local configuration [FDR Local Config.] (<i>L C F G</i>)	R/W	0 = [No] (<i>n O</i>) : The drive configuration is downloaded from an FDR server 1 = [Yes] (<i>Y E S</i>) : The drive configuration is local
60 060	1	Enable FDR fault [FDR Error Mgt.] (<i>F d r F</i>)	R/W	In the event of a problem with the FDR file (missing or invalid) 0 = [No] (<i>n O</i>) : The Ethernet card does not trigger an Ethernet fault 1 = [Yes] (<i>Y E S</i>) : The Ethernet card triggers an Ethernet fault
60 061	1	FDR service command [FDR Action] (<i>F D r A</i>)	R/W	0 = [IDLE] (<i>I d L E</i>) : No command 20 = [SAVE] (<i>S A V E</i>) : Command: save 21 = [REST] (<i>r E S t</i>) : Command: download 22 = [DEL] (<i>d E L</i>) : Command: delete
60 062	1	FDR service state [FDR state] (<i>F D r E</i>)	R	0 = [IDLE] (<i>I d L E</i>) : "Idle" 1 = [INIT] (<i>I N I t</i>) : Initialization 2 = [CONF] (<i>C O N F</i>) : Configuration 3 = [RDY] (<i>r D Y</i>) : Ready 4 = [GET] (<i>G E t</i>) : Downloading the current configuration 5 = [SET] (<i>S E t</i>) : Saving the current configuration 6 = [APP] (<i>A P P</i>) : Writing the FDR server configuration to the drive 7 = [OPE] (<i>O P E</i>) : Operational 8 = [UCFG] (<i>U C F G</i>) : Not configured
60 063	1	Ethernet fault code [FDR fault] (<i>F d r d</i>)	R	When an Ethernet fault is present, this parameter is used to ascertain the cause of the fault. The fault code remains saved after the disappearance of the fault. 2 = The FDR configuration file is not compatible with the drive type (example: the drive is not the correct rating) 3 = Error reading the FDR configuration file on the server 4 = Error writing the FDR configuration file to the server 7 = Time out for receipt of the FDR configuration file from the server 9 = Duplication of IP address 12 = The FDR configuration file is missing

11. Modbus TCP server

Address	Size (in words)	Description	Access	Possible values, comments
60 064	1	Enable periodic saving of the FDR service [FDR autosave] (F d r S)	R/W	0 = [No] (n O) : Periodic saving is disabled 1 = [Yes] (Y E S) : Periodic saving is enabled
60 065	1	Interval for saving the FDR service [FDR t. autosave] (F d r t)	R/W	2 to 9999, unit: min
60 066	1	Number of FDR save operations	R/W	
60 067	1	Number of FDR restore operations	R/W	
60 068	1	Number of FDR deletions	R/W	
60 069	1	FDR file checksum	R	
60 070	5	Reserved	R	
60 075	4	IP address (EEPROM value)	R	IPC1.IPC2.IPC3.IPC4 IPC1 = 60 075 IPC2 = 60 076 IPC3 = 60 077 IPC4 = 60 078
60 079	4	Subnet mask (EEPROM value)	R	IPM1.IPM2.IPM3.IPM4 IPM1 = 60 079 IPM2 = 60 080 IPM3 = 60 081 IPM4 = 60 082
60 083	4	Gateway (EEPROM value)	R	IPG1.IPG2.IPG3.IPG4 IPG1 = 60 083 IPG2 = 60 084 IPG3 = 60 085 IPG4 = 60 086
60 087	20	Reserved	R	
60 107	1	Method of assigning IP addresses	R	0 = Configuration via the display terminal or PC-Software 1 = Configuration via BOOTP 2 = Configuration via DHCP
60 108	4	Adresse IP serveur Email	R/W	
60112	1	Email activation	R/W	Bit 0 : Drive error activation (ETA.3) Bit 1 : Drive alarm activation (ETA.7) Bit 2 : Ethernet error activation Bit 3 : Controller Inside message activation
60113	1	Email status (of the option board)	R	
60114	1	Emails number successfully sent	R/W	
60115	1	Number of errors	R/W	
60116	1	Last error code	R	
60117	85	Email address of the destination	R/W	
60202	85	Email adresse of the sender	R/W	

11. Modbus TCP server

11. 4. List of Modbus functions supported

Code (decimal)	Modbus name	Description	Size of data
3 = 16#03	Read Holding Registers	Read N output words	63 words max.
6 = 16#06	Write Single Register	Write one output word	-
16 = 16#10	Write Multiple Registers	Write N output words	61 words max.
23 = 16#17	Read/Write Multiple Registers	Read/write N words	20/20 words max.
43 = 16#2B	Read Device Identification	Identification	-

11. 5. “Read Holding Registers” (3) function

This Modbus request is used to read the values of a number (No. of Points) of adjacent words starting at the address indicated (Starting Address). The values read are restored one after another, at the end of the response (First Point Data → Last Point Data).

Request format:

Byte	Meaning
0	Function Code = 16#03
1	Starting Address Hi
2	Starting Address Lo
3	No. of Points Hi (0)
4	No. of Points Lo (1 - 63)

Response format:

Byte	Meaning
0	Function Code = 16#03
1	Byte Count (B = 2 × No. of Points)
2	First Point Data Hi
3	First Point Data Lo
...
B	Last Point Data Hi
B+1	Last Point Data Lo

Exception response format:

Byte	Meaning	With the VW3 A3 310d Ethernet card
0	Function Code = 16#83	
1	Exception Code	01 (Illegal Function) 02 (Illegal Data Address) 03 (Illegal Data Value) 04 (Slave device failure)

11. Modbus TCP server

11. 6. "Write Single Register" (6) function

This Modbus request is used to write a given value (Preset Data) to the address supplied (Register Address).

Request format:

Byte	Meaning
0	Function Code = 16#06
1	Register Address Hi
2	Register Address Lo
3	Preset Data Hi
4	Preset Data Lo

Response format:

Byte	Meaning
0	Function Code = 16#06
1	Register Address Hi
2	Register Address Lo
3	Preset Data Hi
4	Preset Data Lo

Exception response format:

Byte	Meaning	With the VW3 A3 310d Ethernet card
0	Function Code = 16#86	
1	Exception Code	01 (Illegal Function) 02 (Illegal Data Address) 03 (Illegal Data Value) 04 (Slave device failure) 06 (Slave device busy) 07 (Write access locked)

11. Modbus TCP server

11.7. "Write Multiple Registers" (16 = 16#10) function

This Modbus request is used to write a number (No. of Registers) of adjacent words starting at a given address (Starting Address). The values to be written are supplied one after another (First Register Data → Last Register Data).

Request format:

Byte	Meaning
0	Function Code = 16#10
1	Starting Address Hi
2	Starting Address Lo
3	No. of Registers Hi (0)
4	No. of Registers Lo (1 - 61)
5	Byte Count (B = 2 × No. of Registers)
6	First Register Data (Hi)
7	First Register Data (Lo)
...
B+4	Last Register Data (Hi)
B+5	Last Register Data (Lo)

Response format:

Byte	Meaning
0	Function Code = 16#10
1	Starting Address Hi
2	Starting Address Lo
3	No. of Registers Hi (0)
4	No. of Registers Lo (1 - 61)

Exception response format:

Byte	Meaning	With the VW3 A3 310d Ethernet card
0	Function Code = 16#90	
1	Exception Code	01 (Illegal Function) 02 (Illegal Data Address) 03 (Illegal Data Value) 04 (Slave device failure) 06 (Slave device busy) 07 (Write access locked)

11. Modbus TCP server

11. 8. “Read/Write Multiple Registers” (23 = 16#17) function

The “Read/Write Multiple Registers” service is reserved for setting up the IO Scanning service (see “IO Scanning” section).

Request format:

Byte	Meaning	With the VW3 A3 310d Ethernet card
0	Function Code = 16#17	16#17
1	Read Reference Address Hi	0 (not handled)
2	Read Reference Address Lo	0 (not handled)
3	Quantity to Read Hi (0)	0
4	Quantity to Read Lo (1 - 63)	32
5	Write Reference Address Hi	0 (not handled)
6	Write Reference Address Lo	0 (not handled)
7	Quantity to Write Hi (0)	0
8	Quantity to Write Lo (1 - 61)	32
9	Byte Count (2 × Quantity to Write)	64
10	Write Data 01 (Hi)	Value of 1st IO Scanner output register (by default: value of the control word (CMd))
11	Write Data 01 (Lo)	
...
72	Write Data 32 (Hi)	PKW output: PKE (Hi)
73	Write Data 32 (Lo)	PKW output: PKE (Lo)

Response format:

Byte	Meaning	With the VW3 A3 310d Ethernet card
0	Function Code = 16#17	16#17
1	Byte Count (2 × Quantity to Write)	64
2	Read Data 01 (Hi)	Value of 1st IO Scanner input register (by default: value of the status word (EtA))
3	Read Data 01 (Lo)	
...
64	Read Data 32 (Hi)	PKW input: PKE (Hi)
65	Read Data 32 (Lo)	PKW input: PKE (Lo)

Exception response format:

Byte	Meaning	With the VW3 A3 310d Ethernet card
0	Function Code = 16#97	
1	Exception Code	01 (Illegal Function) 02 (Illegal Data Address) 03 (Illegal Data Value) 04 (Slave device failure) 06 (Slave device busy) 07 (Write access locked)

11. Modbus TCP server

11. 9. “Read Device Identification” (43 = 16#2B) function

Request format:

Byte	Meaning	With the VW3 A3 310d Ethernet card
0	Function Code = 16#2B	16#2B
1	Type of MEI	16#0E
2	Read Device ID code	16#01: Basic 16#02: Regular 16#03: Extended
3	Object ID	16#00

Response format:

Byte(s)	Meaning	With the VW3 A3 310d Ethernet card
0	Function code = 16#2B	16#2B
1	Type of MEI	16#0E
2	ReadDeviceId code	16#01
3	Degree of conformity	16#02
4	Number of additional frames	16#00 (a single frame)
5	Next object ID	16#00
6	Number of objects	3 for Basic 4 for Regular or Extended
7	Object no. 1 ID	16#00 = Vendor Name
8	Length of object no. 1 (A)	13
9...21	Value of object no. 1 (A ASCII characters)	“SchneiderElectric”
22	Object no. 2 ID	16#01 = Product Code
23	Length of object no. 2 (B)	11 (for the following example only)
24...23+B	Value of object no. 2 (B ASCII characters) (1)	Example: “ATV71HU15M3”
24+B	Object no. 3 ID	16#02 = Major.Minor Revision
25+B	Length of object no. 3 (C)	4
26+B...29+B	Value of object no. 3 (C ASCII characters)	Example: “0201” for version 2.1
30+B	Object no. 4 ID	16#06 = Application Name (2)
31+B	Length of object no. 4 (D)	8 (for the following example only)
32+B...31+B+D	Value of object no. 4 (D ASCII characters) (1)	Example: “MACHINE 4”

(1) The length of this field is variable. Use the “Length of object no. X” field associated with it to determine the length.

(2) In the case of the drive, this data item corresponds to [\[DEVICE NAME\]](#).

The response to a “drive identification” request does not cause an exception response.

12. IO Scanning service

12. 1. Presentation

The IO Scanning service is used to exchange periodic I/O data between:

- A controller or PLC (IO Scanner).
- Devices (IO Scanning servers).

This exchange is usually performed by implicit services, thus avoiding the need to program the controller (PLC). The IO Scanner periodically generates the Read/Write Multiple Registers (23 = 16#17) request.

The IO Scanning service operates if it has been enabled in the PLC and the drive.

The drive parameters assigned to IO Scanning have been selected by default. This assignment can be modified by configuration.

The table below indicates the tools which can be used to modify these configurations:

Functions	Graphic display terminal	Integrated display terminal	PC-Software software workshop	Standard Web server
Enable IO Scanning	•	•	•	•
Configuring the IO Scanning variables			•	•

The drive IO Scanning service can also be configured by the Ethernet card Modbus server.

When the IO Scanning service has been enabled in the Altivar 71 drive:

- A TCP connection is assigned to it.
- The parameters assigned in the periodic variables are exchanged cyclically between the Ethernet card and the drive.
- The parameters assigned to the periodic output variables are reserved for IO Scanning. They cannot be written by other Modbus services, even if the IO Scanner is not sending its periodic output variables.

12. 2. Periodic variables

Output variables (written by IO Scanner)			Input variables (read by IO Scanner)		
No.	Meaning/default assignment	Configurable	No.	Meaning/default assignment	Configurable
0	Reserved	no	0	Reserved	no
1	Control word (CMd)	yes	1	Status word (EtA)	yes
2	Speed setpoint (LFrd)	yes	2	Output speed (rFrd)	yes
3	Not assigned	yes	3	Not assigned	yes
4	Not assigned	yes	4	Not assigned	yes
5	Not assigned	yes	5	Not assigned	yes
6	Not assigned	yes	6	Not assigned	yes
7	Not assigned	yes	7	Not assigned	yes
8	Not assigned	yes	8	Not assigned	yes
9	Not assigned	yes	9	Not assigned	yes
10	Not assigned	yes	10	Not assigned	yes
11-31	Reserved	no	11-31	Reserved	no

It is possible to configure the assignment of periodic variables 1 to 10.

- Note:**
- Avoid configuring the drive configuration parameters as periodic output variables because they cannot be modified with the motor running (DSP 402 state "5-Operation Enabled").
 - Monitoring parameters must not be configured as periodic output variables, because they cannot be written.

12. IO Scanning service

The values of the periodic variables are listed in a table.

This table can be accessed in read-only mode by the Ethernet card Modbus server (Unit ID = 251).

Address	Description	Default value	Address	Description	Default value
40 001	Value of output variable 1	Value of the control word (CMd)	40 017	Value of read register 1	Value of the status word (EtA)
40 002	Value of output variable 2	Value of the speed setpoint (LFrd)	40 018	Value of read register 2	Value of the output speed (rFrd)
40 003	Value of output variable 3		40 019	Value of input variable 3	
40 004	Value of output variable 4		40 020	Value of input variable 4	
40 005	Value of output variable 5		40 021	Value of input variable 5	
40 006	Value of output variable 6		40 022	Value of input variable 6	
40 007	Value of output variable 7		40 023	Value of input variable 7	
40 008	Value of output variable 8		40 024	Value of input variable 8	
40 009	Value of output variable 9		40 025	Value of input variable 9	
40 010	Value of output variable 10		40 026	Value of input variable 10	

12. 3. Address table

The periodic variables are defined in the address table.

This table can be accessed in read-write mode by the Ethernet card Modbus server (Unit ID = 251).

Address	Description	Default value	Address	Description	Default value
50 001	Logic address of output variable 1	Address of the control word (CMd) = 8501	50 017	Logic address of input variable 1	Address of the status word (EtA) = 3201
50 002	Logic address of output variable 2	Address of the speed setpoint (LFrd) = 8602	50 018	Logic address of input variable 2	Address of the output speed (rFrd) = 8604
50 003	Logic address of output variable 3	0	50 019	Logic address of input variable 3	0
50 004	Logic address of output variable 4	0	50 020	Logic address of input variable 4	0
50 005	Logic address of output variable 5	0	50 021	Logic address of input variable 5	0
50 006	Logic address of output variable 6	0	50 022	Logic address of input variable 6	0
50 007	Logic address of output variable 7	0	50 023	Logic address of input variable 7	0
50 008	Logic address of output variable 8	0	50 024	Logic address of input variable 8	0
50 009	Logic address of output variable 9	0	50 025	Logic address of input variable 9	0
50 010	Logic address of output variable 10	0	50 026	Logic address of input variable 10	0

To modify the address table, IO Scanning must be disabled (only when the motor is stopped).

13. FDR service

13. 1. Presentation

The FDR (Faulty Device Replacement) service is used to simplify the maintenance of drives connected on the Ethernet network.

In the event of a drive malfunction, this service automatically reconfigures its replacement.

The new drive (FDR client) retrieves:

- Its IP addresses and the FDR file path from a DHCP server.
- The FDR file from an FTP server, if the drive is not configured in local configuration.

In practice, the DHCP server and the FTP server are the same device (TSX Premium or Quantum PLC).

The FDR file contains:

- The Ethernet parameters (configuration of IO Scanning, FDR etc.).
- The drive parameters (drive, functions, application, etc.).

The FDR service is based on identification of the device by a "Device Name". In the case of the Altivar 71 drive, this is represented by the [\[DEVICE NAME\]](#) parameter.

Configuration using the drive graphic display terminal or the integrated display terminal is explained in the "Configuration" section.

Configuration using the standard Web server is explained in the "Standard Web server" section.

For configuration using the PC-Software workshop, refer to the software online help.

Note: Check that all the network devices do have different "Device Names".

The FDR server controls duplication of "Device Names" (it does not assign an IP address that has already been assigned and is active).

If the same IP address is supplied on 2 devices, the 2nd should trigger an IP address duplication (network management fault which leads to a drive fault [\[External fault com.\]](#) (**E P F 2**) by default).

If the FDR service has been enabled, the Ethernet card attempts to restore its IP addresses on each power-up. Each time the procedure fails, the Ethernet card reiterates its FDR requests (DHCP).

Where the configuration also needs to be downloaded by the FDR server:

After assigning the Ethernet card IP addresses, if the configuration download fails, the Ethernet card detects a network management fault (which leads to a drive fault [\[External fault com.\]](#) (**E P F 2**) by default).

13. FDR service

13. 2. Local configuration

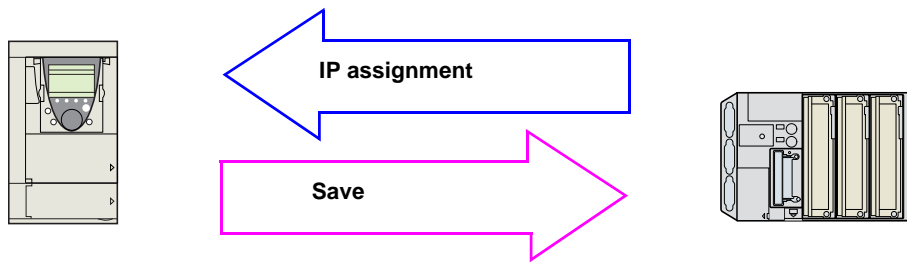

If the drive parameter configuration is local, the FDR server only assigns the IP addresses:

- Card IP address.
- Subnet mask.
- Gateway IP address.

On connection to the network, the drive automatically saves its parameters in the FDR server.

To make the system operational, it is necessary to:

- Configure the FDR server.
- Configure the drive.
- Turn off the drive.
- Connect the drive to the network.

❑ Configure the FDR server

See the PLC manual or the section on software setup using PL7.

❑ Configure the drive

In the [1.9 - COMMUNICATION] (C O N -) menu, [ETHERNET] (E t H -) submenu:

- Leave the IP address [IP card] (I P C 1) (I P C 2) (I P C 3) (I P C 4) at the value [0.0.0.0] (0) (0) (0) (0)
- Enable the FDR service: [FDR validation] (F d r U) = [Yes] (Y E S)
- Select local drive configuration: [FDR Local Config.] (L C F G) = [Yes] (Y E S)

Enter the device name, [DEVICE NAME], in the [7. DISPLAY CONFIG.] menu, [7.1 USER PARAMETERS] submenu.

This menu can only be accessed in expert mode: In the [2 ACCESS LEVEL] (L A C -) menu, set the level to [expert] (E P r).

❑ Turn the drive off and then back on again

Turn the drive off and then back on again (control voltage if a separate power supply is being used), otherwise the device name is not taken into account.

❑ Connect the drive to the network

13. FDR service

13. 3. Downloaded configuration

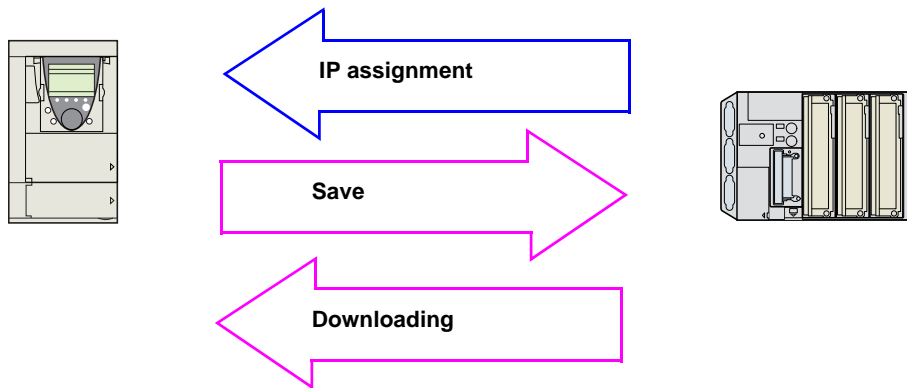

If the drive parameter configuration has been downloaded, the FDR server assigns:

□ The IP addresses

- Card IP address.
- Subnet mask.
- Gateway IP address.
- FDR server IP address.

□ Drive parameters (configuration)

■ First use

Procedure:

- Configure the drive.
- Turn off the drive.
- Connect the drive to the network.
- Configure the FDR server (see the PLC manual).
- Supply the FDR server with the configuration file.
- Check that the system is operational.

In the procedure described below, the configuration file is supplied to the FDR server, via the Ethernet network, using a save command performed on the drive graphic display terminal.

Note: This procedure can also be performed using a Web browser, which is more user-friendly than the drive graphic display terminal (see the “Standard Web server” section).

□ Configure the drive

In the [1.9 - COMMUNICATION] (C O N -) menu, [ETHERNET] (E T H -) submenu:

- Leave the IP address [IP card] (I P C 1) (I P C 2) (I P C 3) (I P C 4) at the value [0.0.0.0] (0) (0) (0) (0).
- Enable the FDR service: [FDR validation] (F d r U) = [Yes] (Y E S).
- **Caution**, before the first connection, you must select local drive configuration: [FDR Local Config.] (L C F G) = [Yes] (Y E S).
The drive must first supply the configuration to the server.

⚠ WARNING

RISK OF UNINTENDED EQUIPMENT OPERATION

Always select the local configuration option [FDR Local Config.] (L C F G) = [Yes] (Y E S) when configuring the first drive. If this option is not selected, an invalid or null configuration file may be uploaded to the FDR server. Subsequent drives would then receive incorrect configuration files, leading to unexpected behavior.

Failure to follow this instruction can result in death, serious injury, or equipment damage.

Enter the device name, [DEVICE NAME], in the [7. DISPLAY CONFIG.] menu, [7.1 USER PARAMETERS] submenu.

This menu can only be accessed in expert mode: In the [2 ACCESS LEVEL] (L A C -) menu, set the level to [expert] (E P r).

□ Turn the drive off and then back on again

Turn the drive off and then back on again (control voltage if a separate power supply is being used), otherwise the device name is not taken into account.

□ Connect the drive to the network

13. FDR service

□ Download the IP addresses

- Connect the drive and the FDR server (PLC) to the Ethernet network.
- The server downloads the IP addresses to the Ethernet card.

Check that the operation has proceeded correctly:

- The "STS" LED should be on.

You can also check, in the [1.9 - COMMUNICATION] (C O N -) menu, [ETHERNET] (E t H -) submenu whether the [IP card] (I P C 1) (I P C 2) (I P C 3) (I P C 4), [IP Mask] (I P M 1) (I P M 2) (I P M 3) (I P M 4) and [IP Gate] (I P G 1) (I P G 2) (I P G 3) (I P G 4) parameters have values other than [0.0.0.0] (0) (0) (0) (0).

□ Save the drive configuration parameters in the FDR server

- Configure the drive parameters.

In the [1.9 - COMMUNICATION] (C O N -) menu, [ETHERNET] (E t H -) submenu:

- Specify that the drive configuration is to be downloaded from the FDR server on each power-up: [FDR Local Config.] (L C F G) = [No] (n 0).
- Send a save command to the FDR server: [FDR Action] (F d r A) = [SAVE] (S A U E).

After execution of the command, the [FDR Action] (F d r A) parameter reverts to the value [IDLE] (I d L E).

□ Check that the system is operational

Check that the operation has proceeded correctly:

- The "STS" LED should be on.
- The [FDR state] (F d r E) parameter should be at the value [OPE] (O P E).

If the save operation has not been successful, the card detects a communication (network management) fault which, in factory settings mode, triggers a drive fault [External fault com.] (E P F 2).

■ Replacing a drive

Procedure:

- Configure the drive.
- Turn off the drive.
- Connect the drive to the network.
- Check that the drive is operational.

□ Configure the drive

In the [1.9 - COMMUNICATION] (C O N -) menu, [ETHERNET] (E t H -) submenu:

- Leave the IP address [IP card] (I P C 1) (I P C 2) (I P C 3) (I P C 4) at the value [0.0.0.0] (0) (0) (0) (0).
- Enable the FDR service: [FDR validation] (F d r U) = [Yes] (Y E S).
- Specify that the drive configuration is to be downloaded from the FDR server on each power-up: [FDR Local Config.] (L C F G) = [No] (n 0).

These configurations are the default values.

Enter the device name, [DEVICE NAME], in the [7. DISPLAY CONFIG.] menu, [7.1 USER PARAMETERS] submenu.

This menu can only be accessed in expert mode: In the [2 ACCESS LEVEL] (L A C -) menu, set the level to [expert] (E P r).

□ Turn the drive off and then back on again

Turn the drive off and then back on again (control voltage if a separate power supply is being used), otherwise the device name is not taken into account.

□ Connect the drive to the network

□ Check that the system is operational

Check that the operation has proceeded correctly:

- The "STS" LED should be on.
- The [FDR state] (F d r E) parameter should be at the value [OPE] (O P E).

If downloading has not been possible after a period of 2 min following assignment of the IP addresses, the card detects a communication (network management) fault which, in factory settings mode, triggers a drive fault [External fault com.] (E P F 2).

13. FDR service

13. 4. Periodic saving

Periodic saving of the drive configuration can be configured on the FDR server in either local configuration or downloaded configuration mode.

In the [1.9 - COMMUNICATION] (C O N -) menu, [ETHERNET] (E T H -) submenu:

- Select: [FDR autosave] (F d r S) = [Yes] (Y E S).
- Set the [FDR t.autosave] (F d r t) parameter.

Note: Saving too often risks overburdening the network and adversely affecting its performance (factory setting: 10 min).

13. 5. Other commands

On request, the configuration saved in the FDR server can be downloaded to the drive using the [FDR Action] (F d r A) command = [REST] (r E S T).

The saved configuration can be deleted from the FDR server using the [FDR Action] (F d r A) command = [DEL] (d E L).

13. 6. Configuration file

The configuration file, XXXX.prm where XXXX is the DeviceName, is an HTML file which contains the entire drive configuration as a comment.

The HTML format is a simple way of providing the user with a summary of the configuration. An example appears below:

FDR Configuration File

File Revision: 2
ATV Revision: 1.0IE1.0
Catalog number: ATV-71HU15M3
Checksum File: SE92

■ Limitations

- The FDR configuration file XXXX.prm coming from an Ethernet V2.1 option board can not be applied on a V1.1 option board (and idem from an V3.0 to a V1.1), an ILF fault appears.
- The FDR service is able to store the current configuration of the drive, but does not provide the possibility to store multi-configurations or multi-parameters configurations.

14. Standard Web server

14. 1. Web server functions

Menu	Page	Function
HOME	English	Home page
MONITORING	Altivar Viewer	Display of the main drive parameters (motor speed, state of drive logic and analog I/O, status)
	Data Viewer	Display and modification (password-protected) of the drive parameters, arranged by category
	Altivar Chart	Display of two drive parameters (speed, voltage, etc.) in the form of an oscilloscope type time chart
DIAGNOSTICS	Ethernet Statistics	Display and resetting of the communication statistics
		Drive identification
SETUP	[Security] HTTP password	Changing the HTTP password used to access the Web server
	[Security] Data write password	Changing the Write password that allows modification of the parameters
	FDR Agent	Display of the state and management of the Ethernet card FDR agent
	IO Scanner	Display and modification (password-protected) of the assignment of the IO Scanning periodic variables
		Enabling and disabling of IO Scanning (password-protected)
Setting (password-protected) of the IO Scanning and Modbus TCP messaging time outs		
DOCUMENTATION	References	Link to the site http://www.schneider-electric.com

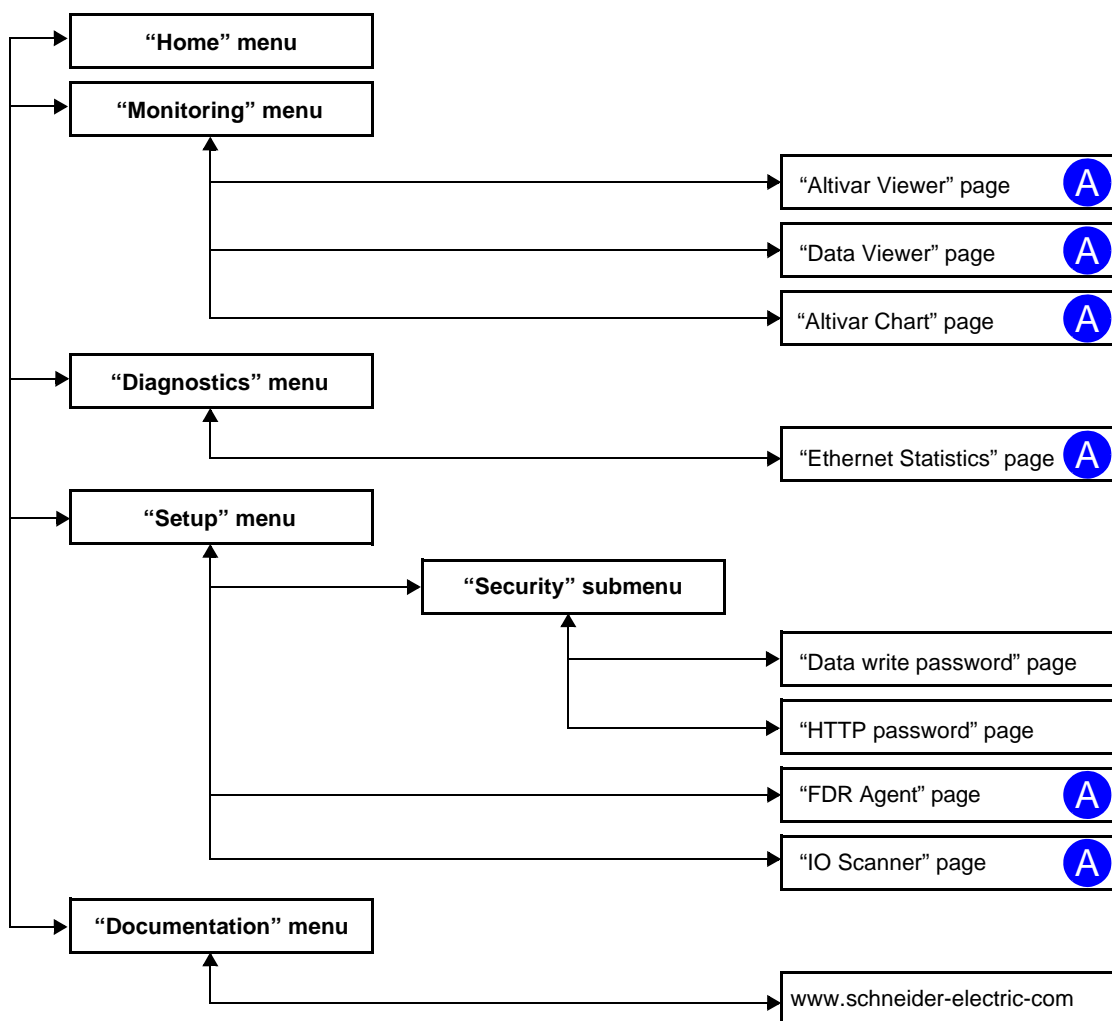

Pages which contain applets are marked "A".

14. Standard Web server

14. 2. Applets

The Web server downloads Java programs called “applets” to your computer. These applets communicate with the drive using Modbus services (on port 502), thus establishing one or more connections between the computer and the drive. Until an applet has been fully transmitted from the drive to the browser, a gray rectangle appears in the place reserved for it in the page.

The applet connects when the page is opened and remains connected until the page is closed.

Display problems can appear with the internet Explore default JVM. Use the SUN Java virtual machine V1.6.

The applets associated with the Web pages monitor communication with the drive. When the drive no longer responds to requests to update the data, the message “Link down” is displayed in one field and all the other field contents are emptied.

Subsequently, the description of each page indicates the data refresh period requested by the applet loaded on the computer. The refresh period actually observed depends on:

- The performance of the computer on which the Web browser is running.
- The communication system response time.
- The amount of data to be refreshed on the page.

14. Standard Web server

14. 3. Access to the Web server

Number of Modbus TCP connections	0
----------------------------------	---

To connect to the Web server of a drive located, for example, at IP address 139.160.69.241 enter the URL “<http://139.160.69.241/>” in the address bar of a Web browser.

When the browser first connects to the drive Web server, it requests entry of a user name and a password (HTTP password).



By default, the user name and the password (HTTP password) are both “USER” (upper case).

If authentication is accepted, the home page is displayed. If not, after three failed attempts, access to this page is denied:

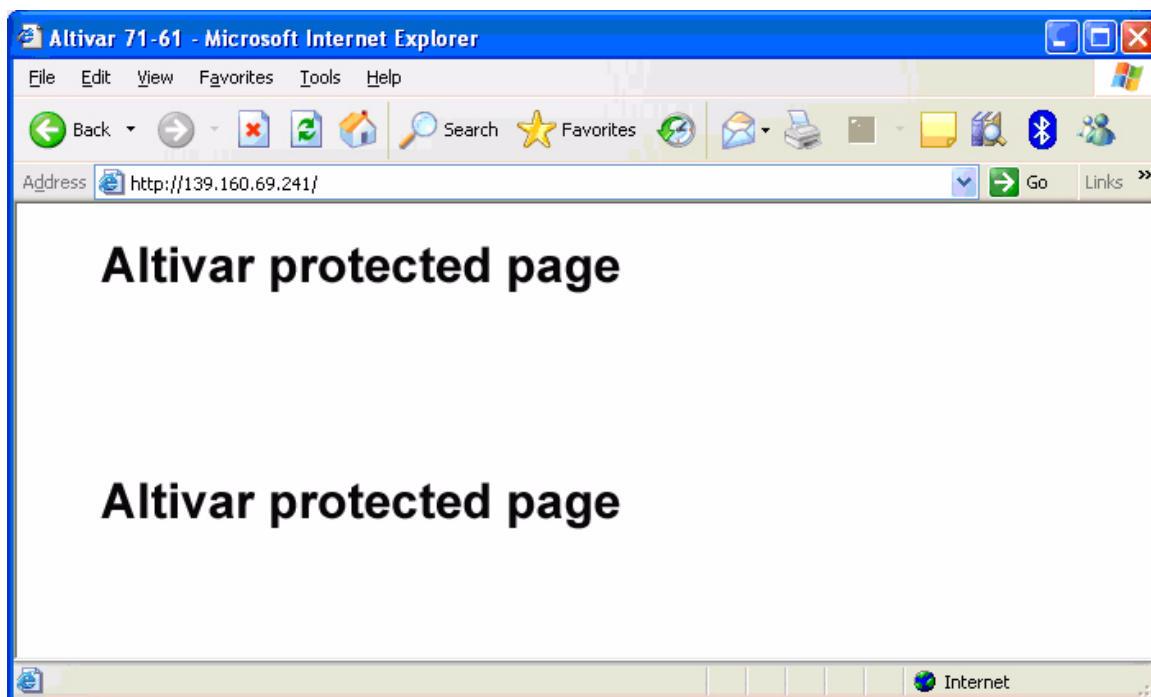

To attempt a new connection to the drive server home page, simply refresh the Web browser display (F5 key or “Refresh” button, for example).

14. Standard Web server

14. 4. Web server user interface

All the drive Web server pages have the same appearance:

1 A bar at the top containing links to HTML pages for the main menus: “Home”, “Documentation”, “Monitoring”, “Control”, etc.

This bar is the same regardless of which HTML page is being viewed.

Note: The “Control” and “Maintenance” menus are inoperative and grayed-out. They only appear because of the “Transparent Ready” common interface.

2 A menu down the left-hand side which displays links to the HTML pages available in the selected menu.

3 The center part of the window displays the information for the selected page.

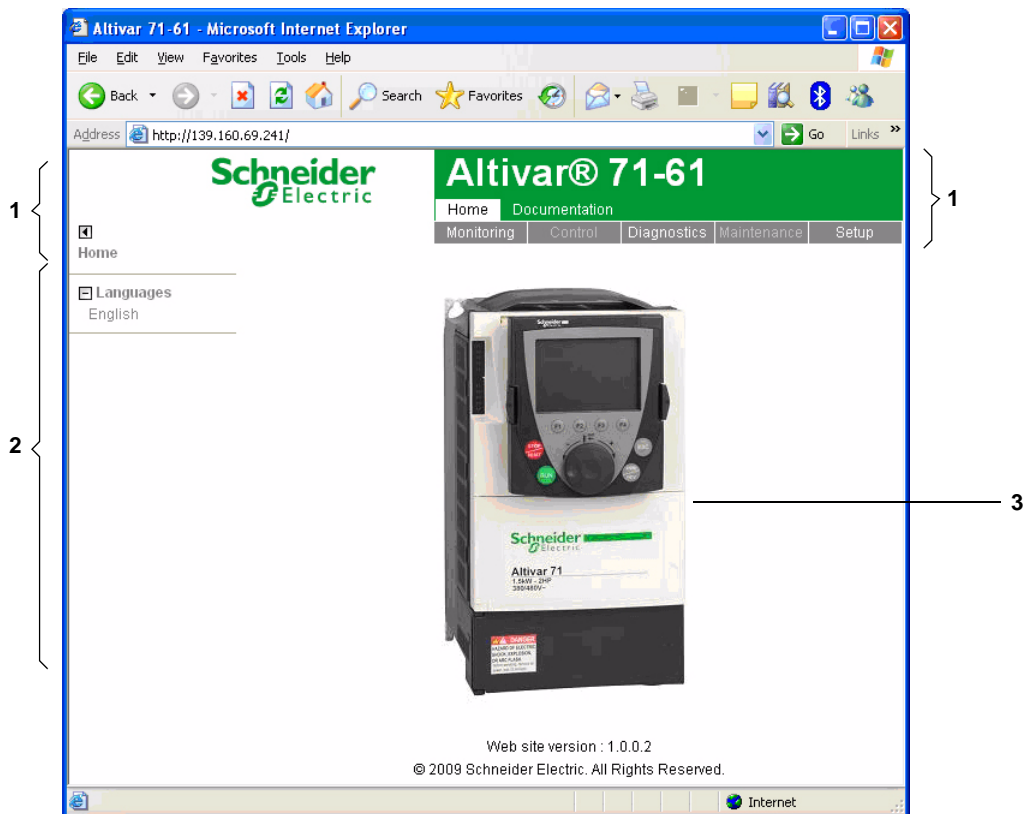

14. 5. “Home” menu

Number of Modbus TCP connections	0
----------------------------------	---

The home page or “Home” menu contain the following items:

- A “Languages” submenu containing:
 - A link to the “English” page

The only link in the “Languages” submenu sends the user to the home page in English and configures the Web browser to open the HTML pages located in the corresponding directory (e.g., the “http://139.160.69.241/html/english/” directory becomes the standard directory in the case of English).

14. 6. “Monitoring” menu

Number of Modbus TCP connections	0
----------------------------------	---

The “Monitoring” menu contains the following items:

- A link to the “Altivar Viewer” page.
- A link to the “Data Viewer” page.
- A link to the “Altivar Chart” page.

14. Standard Web server

14.7. "Altivar Viewer" page

Number of Modbus TCP connections

Refresh period

This page gives an overview of the drive state.

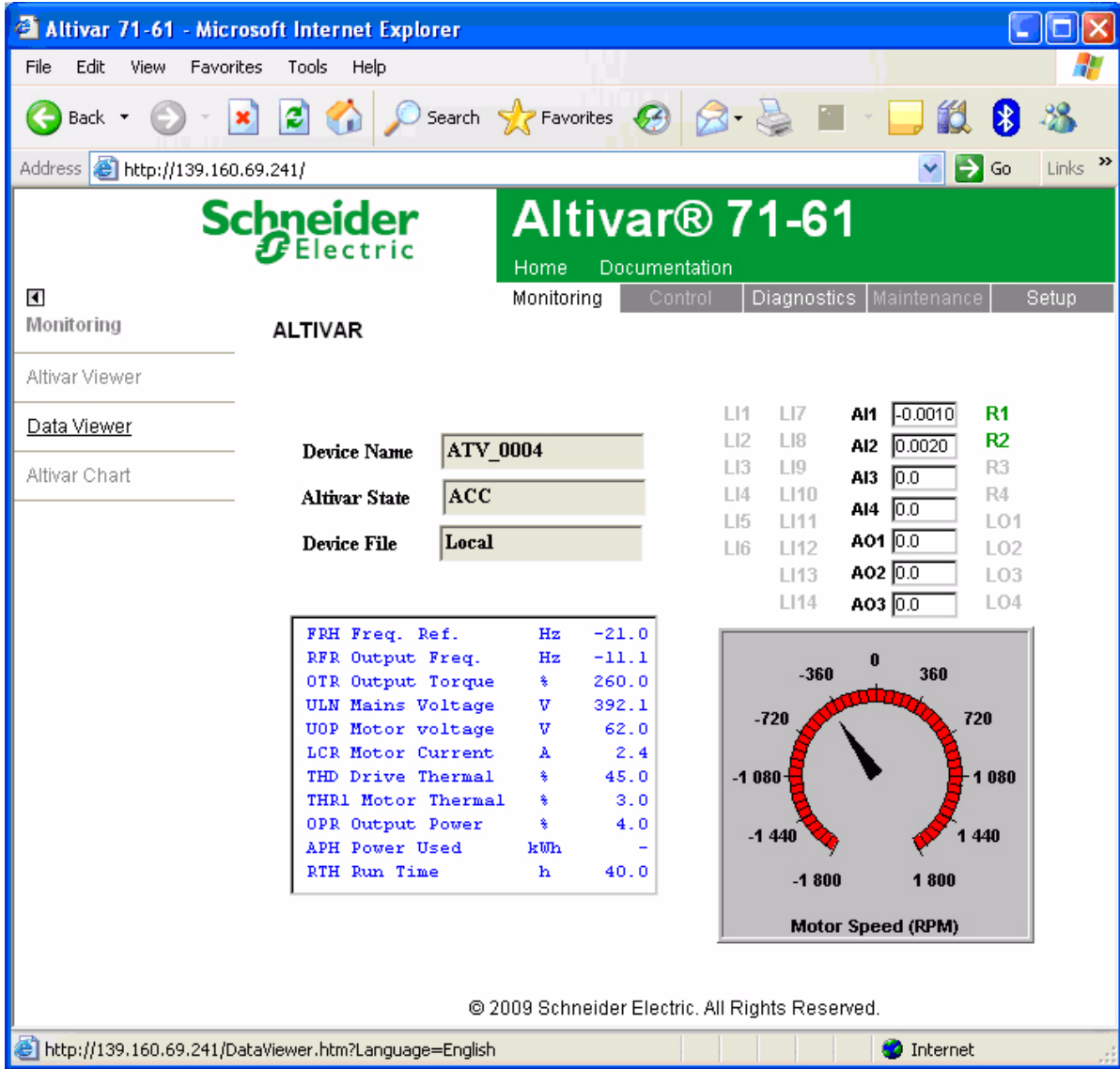

The state indicated in the "Altivar State" field corresponds to the display on the drive integrated display terminal. A delay may sometimes be noticed between the displays on the Web server and the display terminal, depending on the performance of the computer used to display the pages using a Web browser and the communication system performance.

The motor speed displayed on the "Motor Speed" gauge is calibrated according to the maximum frequency [Max frequency] (f_r) and the number of pairs of poles [Pr] (PPr).

The LI... area gives the state of the drive terminals (logic inputs LI1 to LI14, logic outputs LO1 to LO4, relay outputs R1 to R4, analog inputs AI1 to AI4 and analog outputs AO1 to AO3). When a logic input is active, the LED is green. When a logic output is active, the LED is red.

14. Standard Web server

14. 8. "Data Viewer" page

This page is used to display the drive parameters and modify their values. The parameters are arranged in groups, and consistent with the keypad and user manuals. The display mode for each value depends on the nature of the parameter.

- The unit for the physical values is displayed in the "Unit" column.
- The registers (bit fields) are displayed in hexadecimal format (16#xxxx).
- Signed values are displayed as such.

To begin the monitoring, click the "Start animation" button :

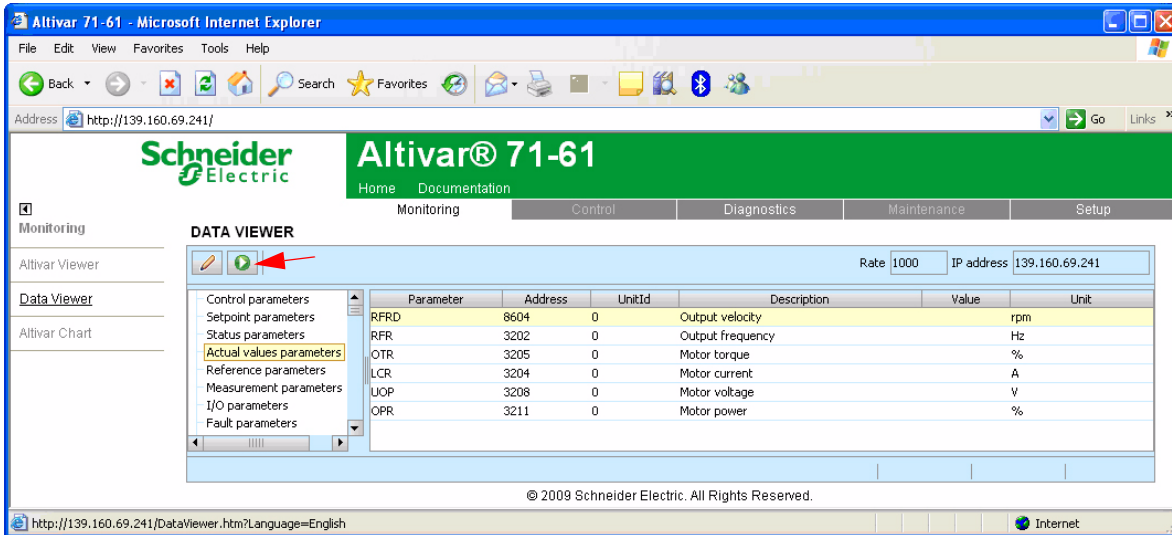

To modify the parameter value, click the "Write value of selected row" button then select the parameter to modify

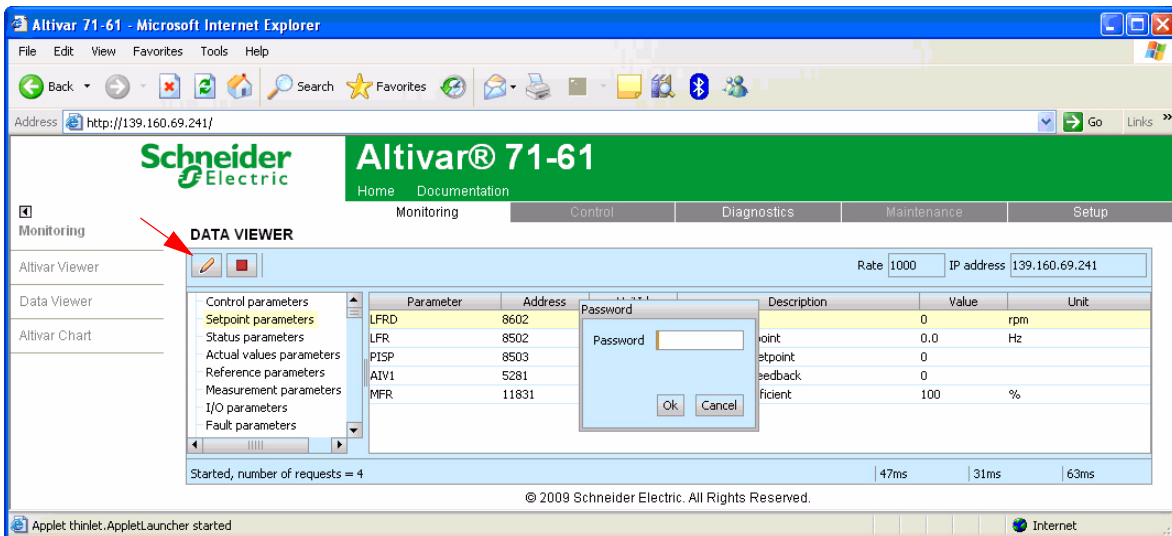

It is only possible to modify the parameter values after entering the "Write password" (see "HTTP password" and "Data write password pages" section on page 55). Click on the "Password" button to enter this password. An entry field then appears in the parameter table, and also a "Cancel" button, for canceling the password entry. After entering the password, press the Enter key so that it is taken into account by the Web browser.

When the value of a parameter cannot be modified, a warning appears : "This parameter can't be written !" This is the case for all parameters until you have correctly entered the Password.

If IO Scanning has been enabled, modifying the value of a parameter assigned to periodic output variables will have no effect since this value is updated cyclically by the PLC. The same applies if a parameter is written periodically by a Modbus service.

WARNING : It is possible to write the command word using the DATA VIEWER. It is mandatory to configure an IP Master in order to avoid any not desired action

14. Standard Web server

14. 9. “Altivar Chart” page

Number of Modbus TCP connections	1	Refresh period	1 s
----------------------------------	---	----------------	-----

This page is used to see how two drive parameters evolve over time.

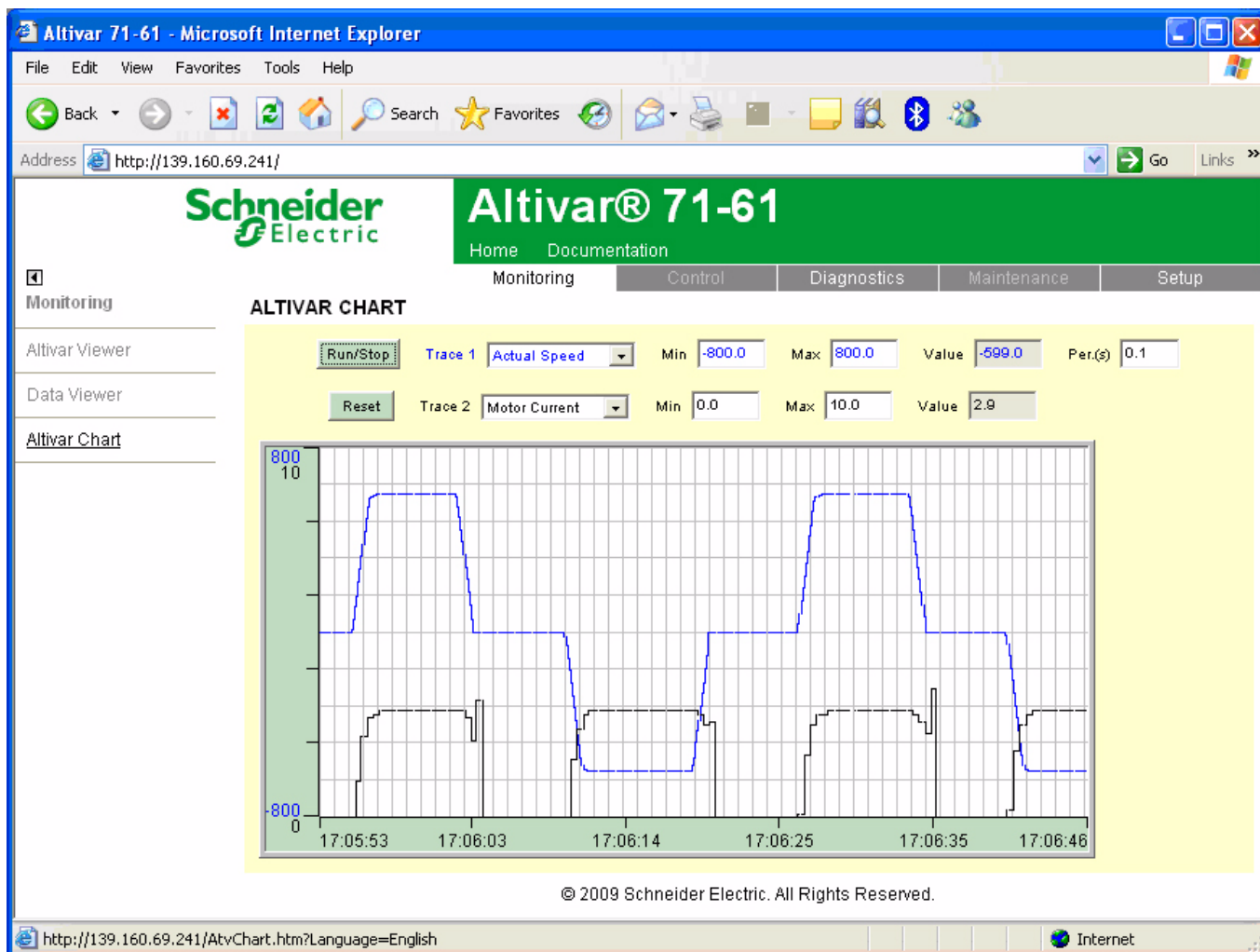

Two parameters can be selected and displayed simultaneously. To do this, select them in the **Trace1** and **Trace2** list. To define the display range better, you can modify the curve min and max points by entering the values directly in the fields: **Min** and **Max** of each trace.

In order to speed up sampling, it is possible to put the value 0 in the **Intv(s)** entry field.

Note: Entering the value 0 increases the traffic on the Ethernet network and can cause collision problems if there is too much traffic, thereby reducing the overall network performance. The sampling period can be increased.

To start the oscilloscope function, press the **Run/Stop** button. Pressing the button again halts sampling and updates the screen.

Reset: clears the active traces.

14. 10. “Diagnostics” menu

Number of Modbus TCP connections	0
----------------------------------	---

The “Diagnostics” menu contains the following item:

- A link to the “Ethernet Statistics” page.

14. Standard Web server

14. 11. "Ethernet Statistics" page

Number of Modbus TCP connections	1	Refresh period	0.5 s
----------------------------------	---	----------------	-------

This page provides the Ethernet statistics and the drive identification data.

The screenshot shows the 'Altivar 71-61' web interface in a Microsoft Internet Explorer browser. The page title is 'Altivar® 71-61' and the URL is 'http://139.160.69.241/'. The interface includes a navigation menu with 'Monitoring', 'Control', 'Diagnostics', 'Maintenance', and 'Setup'. The 'Diagnostics' menu is expanded to show 'Ethernet & TCP-IP STATISTICS'. The statistics are displayed in a table format with three columns: 'Emission statistics', 'Reception statistics', and 'Other errors'. A 'Reset counters' button is located below the statistics table. The footer of the page reads '© 2009 Schneider Electric. All Rights Reserved.'

ETHERNET & TCP-IP STATISTICS	
Device Name	ATV_0004
MAC Address	00-80-f4-7c-fa-af
IP Address	139.160.69.241
NetMask	255.255.255.0
Gateway	0.0.0.0
Status port 0 - 1	100Mb/s - NC
Device Type	ALTIVAR 61
Device Reference	ATV61HU22N4
Software Version	3.0ie10
IP Configuration	Local

Emission statistics		Reception statistics		Other errors	
Emissions	15199	Receptions	16487	Collisions	0
Deferred Emissions	0	CRC Errors	0	Multi Collisions	0
Late Collisions	0	Frame Errors	0	Over Run	0
Buffer Errors	0	Buffer Errors	0	Error Messages	1702
Emission Messages	29232	Reception Messages	15074	IO Scan Errors	0
IO Scan Emissions	0	IO Scan Receptions	0	Connexions (502)	1
Traffic (msg/s)	6	Max. Traffic (msg/s)	154		

Reset counters

© 2009 Schneider Electric. All Rights Reserved.

14. 12. "Setup" menu

Number of Modbus TCP connections	0
----------------------------------	---

The "Setup" menu contains the following items:

- A "Security" submenu containing:
 - A link to the "HTTP password" page.
 - A link to the "Data write password" page.
- A link to the "FDR Agent" page.
- A link to the "IO Scanner" page.
- A link to the "Email" page.

14. Standard Web server

14. 13. "HTTP password" and "Data write password pages"

Number of Modbus TCP connections (for each page)	0
--	---

These two pages are used to modify the two Web server passwords.

By default, the user name and both passwords are: "USER" (upper case).

The user name can only be modified using the PC-Software workshop.

The user name and the "HTTP password" are used to access the Web server in display mode.

The "Write password" is used to access the Web server in modification mode.

When the value of a parameter cannot be modified, the background of the corresponding cell appears grayed-out. This is the case for all parameters until you have correctly entered the "Write password".

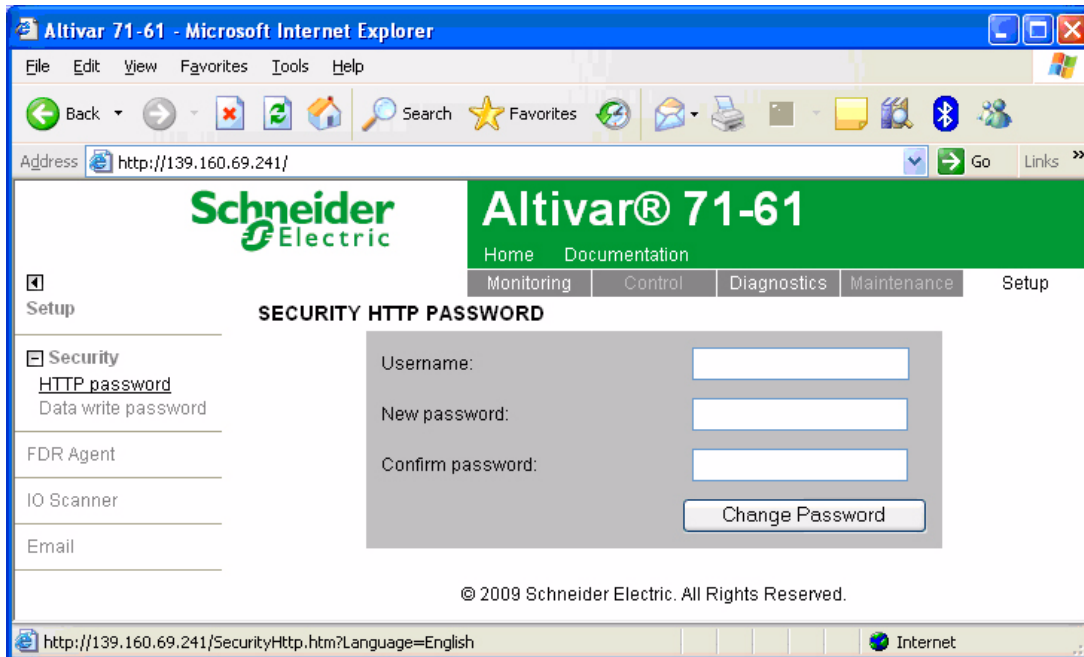

Note: Do not lose the user name or the passwords. If they are lost, the Web server can no longer be used, and the card has to be sent for repair.

14. Standard Web server

14. 14. "FDR Agent" page

Number of Modbus TCP connections	1	Refresh period	1s
----------------------------------	---	----------------	----

This page displays the main parameters used by the VW3 A3 310d Ethernet card FDR function and is used to configure these parameters. See the "FDR Service" section.

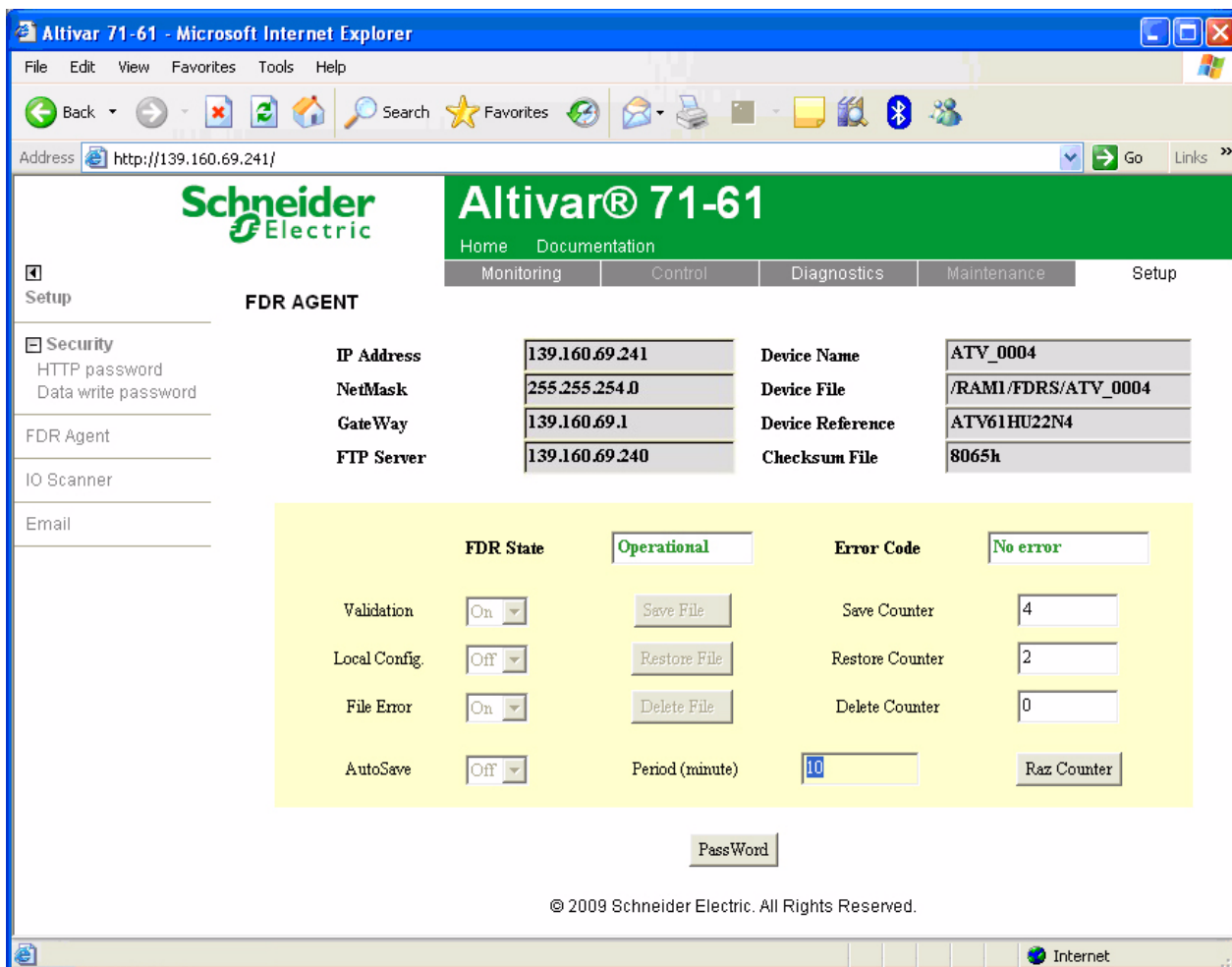

Information on the FDR Agent page	Corresponding terminal display	Description/Possible values
IP Address	[IP card] (IPC-)	Ethernet card IP address
NetMask	[IP Mask] (IPN-)	Subnet mask
Gateway	[IP Gate] (IPG-)	Gateway IP address
FTP Server	[IP FDR] (IPF-)	Indicates the IP address of the FDR server that has supplied the Ethernet card configuration, in particular its IP addresses. This is the server which also supplies the drive configuration file, if [FDR Local Config.] (LCFG) = [No] (n0).
DeviceName	[DEVICE NAME]	Used by the DHCP server to assign the Ethernet card IP addresses dynamically (example: Machine 157).
Device File	Not accessible	Name of FDR configuration file. The file name is consistent with the DeviceName (in our example: Machine 157.prm). If the FDR server file has not been downloaded to the drive, "Local" is displayed in this field.
Device Reference	-	Drive catalog number.
Checksum File	Not accessible	Drive configuration Checksum value. Whenever a drive parameter is modified, this value changes.

14. Standard Web server

Information on the FDR Agent page	Corresponding terminal display	Description/Possible values
Validation	[FDR validation] (F d r U)	Enables the FDR function <ul style="list-style-type: none"> Off = [No] (n O): FDR service disabled. On = [Yes] (Y E S): FDR service enabled.
Local Config	[FDR Local Config.] (L C F G)	Selection of local or server configuration <ul style="list-style-type: none"> Off = [No] (n O): The drive configuration is downloaded from an FDR server. On = [Yes] (Y E S): The drive configuration is local.
File Error	[FDR Error Mgt.] (F d r F)	Enables the FDR fault management process. <ul style="list-style-type: none"> Off = [No] (n O): In the event of a problem with the FDR file (missing or invalid), the Ethernet card does not trigger an Ethernet (network management) fault. On = [Yes] (Y E S): In the event of a problem with the FDR file (missing or invalid), the Ethernet card triggers a network management fault.
AutoSave	[FDR autosave] (F d r S)	Enables periodic saving of the FDR service. <ul style="list-style-type: none"> Off = [No] (n O): Automatic saving disabled. On = [Yes] (Y E S): Automatic saving enabled.
Period	[FDR t.autosave] (F d r t)	Interval for periodic saving of the FDR service. 2 min to 9999 min
FDR State	[FDR state] (F d r E)	FDR service state. <ul style="list-style-type: none"> Idle = [IDLE] (I d L E): FDR service inactive. Initialization = [INIT] (I n I t): Initialization of the current Ethernet card. Configuration = [CONF] (C O n F): Configuration of the current Ethernet card. Ready = [RDY] (r d Y): Ethernet card ready. Get Conf = [GET] (G E t): Downloads the current configuration from the FDR server. Store Conf = [SET] (S E t): Saves the current configuration to the FDR server. Apply Conf = [APP] (A P P): Writes the FDR server configuration to the drive. Operational = [OPE] (O P E): Operational. Unconfigured = [UCFG] (U C F G): FDR service fault.
Error Code	[FDR fault] (F d r d)	Ethernet error code. <ul style="list-style-type: none"> No error = [0]: No fault. Service Unavailable = The FDR server is not available. = [2]: The FDR configuration file is not compatible with the drive type (example: the drive is not the same rating as that defined in the FDR file). = [3]: Error reading the FDR configuration file on the server. = [4]: Error writing the FDR configuration file to the server. = [7]: Time out for receipt of the FDR configuration file from the server. = [9]: Duplication of IP address. File Not Found = [12]: The FDR configuration file is missing. = [203]: Inconsistent hardware configuration.
Save Counter	Not accessible	Number of times the configuration has been saved to the FDR server. This counter is incremented even if the drive configuration is identical to that of the server.
Restore Counter	Not accessible	Number of times the configuration has been downloaded from the FDR server. This counter is not incremented if the drive configuration is identical to that of the server (comparison of checksums).
Delete Counter	Not accessible	Number of times the configuration file has been deleted in the FDR server.
Save File	[FDR Action] (F d r A)	Command to save the configuration to the FDR server. Corresponds to the display terminal command: [SAVE] (S A V E).
Restore File	[FDR Action] (F d r A)	Command to download the configuration from the FDR server. Corresponds to the display terminal command: [REST] (R E S T).
Delete File	[FDR Action] (F d r A)	Command to delete the configuration file in the FDR server. Corresponds to the display terminal command: [DEL] (d E L).
Reset counter	Not accessible	Command to reset the "Save counter", "Restore counter" and "Delete counter" counters.

14. Standard Web server

14. 15. "IO Scanner" page

Number of Modbus TCP connections	1
----------------------------------	---

Refresh period	1s
----------------	----

This page is used to:

- Enable or disable IO Scanning.
- Display and modify assignment of the IO Scanning periodic variables.
- Set the communication monitoring time out.

The default configuration is described in the screen below:

The screenshot shows the Schneider Electric Altivar 71-61 web interface. The browser title is "Altivar 71-61 - Microsoft Internet Explorer". The address bar shows "http://139.160.69.241/". The page header includes the Schneider Electric logo and "Altivar® 71-61". Below the header is a navigation menu with "Monitoring", "Control", "Diagnostics", "Maintenance", and "Setup". The "IO SCANNER" page is active, showing a "Reference" field with "ATV61HU22N4" and a "Device Name" field with "ATV_0004".

Output Parameters

	Parameter	Address	Description
1	CMD	8501	Control word
2	LFRD	8602	Speed setpoint
3	SP2	11410	Preset speed 2
4	SP3	11411	Preset speed 3
5	SP4	11412	Preset speed 4
6	SP5	11413	Preset speed 5
7	SP6	11414	Preset speed 6
8	SP7	11415	Preset speed 7
9	SP8	11416	Preset speed 8
10	-0-	0	Not Assigned

Input Parameters

	Parameter	Address	Description
1	ETA	3201	Status word
2	RFRD	8604	Output velocity
3	SP2	11410	Preset speed 2
4	SP3	11411	Preset speed 3
5	SP4	11412	Preset speed 4
6	SP5	11413	Preset speed 5
7	SP6	11414	Preset speed 6
8	SP7	11415	Preset speed 7
9	SP8	11416	Preset speed 8
10	-0-	0	Not Assigned

At the bottom of the page, there is a "PassWord" button and a configuration bar with "Master" set to "Not defined", "IoScanner" set to "Yes", and "Time Out (s)" set to "20.0".

All modifications are protected by the "Write password" modification password. Click on the "PassWord" button to enter the "Write password". After correctly entering the password, you can access "IoScanner", "Time Out (s)", "Master", "Output parameters", "Input parameters" and the "Save" and "Abort" buttons. By default, the password is "USER". It can be modified in the "Data write password" page.

14. Standard Web server

■ Enabling IO Scanning

Control by the IO Scanner is enabled if the “IoScanner” field is at the value “Yes” and disabled by the value “No”.

The “IoScanner” field corresponds to the parameter [IO Scan.activ.] (I O S A).

WARNING

RISK OF UNINTENDED EQUIPMENT OPERATION

- Do not disable a drive's IO scanning support when the PLC is using the IO scanner to monitor/control client devices.
- Do not modify the assignment of the periodic variables if the PLC is using IO scanning to monitor/control client devices.

Disabling a drive's IO Scanning or modifying the assignment of periodic variables can result in a loss of control via the network, and could result in unintended equipment operation.

Failure to follow this instruction can result in death, serious injury, or equipment damage.

Note: Disabling IO Scanning results in loss of control if a PLC is using an IO Scanner.

Before disabling IO Scanning, you must disable the time out (set the value to 0). However, communication monitoring remains active and the card triggers a communication fault at the end of the period defined by the time out. In factory settings mode, the drive then changes to [Com. network] (C n F) fault mode.

Once the value in the “IoScanner” field has been modified, it may take a while to update the page, depending on the capacity of your computer.

The “IoScanner” field corresponds to the parameter [IO Scan.activ.] (I O S A).

■ Assigning the IO Scanning periodic variables

Note: Modifying the assignment of the periodic variables can result in loss of control if a PLC is using an IO Scanner.

To modify the IO Scanning periodic variables, proceed as follows:

- 1 Enter “No” in the “Io Scanner” field.
- 2 Modify the assignment of periodic variables.
- 3 Apply these modifications using the “Save” button.
- 4 Enter “Yes” in the “Io Scanner” field.

Once the value in the “IoScanner” field has been set to “No”, it may take a while to update the page, depending on the capacity of your computer.

A dropdown menu is used to modify the assignment of each of the periodic variables.

Click on the periodic variable whose assignment you wish to modify, then choose the code corresponding to the drive parameter to be assigned.

All modifications to “Output parameters” and/or “Input parameters” can be confirmed by clicking the “Save” button or canceled by clicking the “Abort” button.

Each time the “Save” button is pressed the address table will be saved to an EEPROM on the Ethernet card. The assignments are now saved, even if the power is turned off.

14. Standard Web server

Altivar 71-61 - Microsoft Internet Explorer

File Edit View Favorites Tools Help

Address <http://192.168.0.2/> Go Links

Schneider Electric **Altivar® 71-61**

Home Documentation

Monitoring Control Diagnostics Maintenance Setup

IO SCANNER

Reference Device Name

Output Parameters

	Parameter	Address	Description
1	CMD	8501	Control word
2	LFRD	8602	Speed setpoint
3	SP2	11410	Preset speed 2
4	ACC	11411	Preset speed 3
5	ADC	11412	Preset speed 4
6	A11E	11413	Preset speed 5
7	A11F	11414	Preset speed 6
8	A11S	11415	Preset speed 7
9	A11T	11416	Preset speed 8
10	SP8	11416	Preset speed 8
10	-.0-	0	Not Assigned

Input Parameters

	Parameter	Address	Description
1	ETA	3201	Status word
2	RFRD	8604	Output velocity
3	SP2	11410	Preset speed 2
4	SP3	11411	Preset speed 3
5	SP4	11412	Preset speed 4
6	SP5	11413	Preset speed 5
7	SP6	11414	Preset speed 6
8	SP7	11415	Preset speed 7
9	SP8	11416	Preset speed 8
10	-.0-	0	Not Assigned

Save Abort

Master IoScanner Time Out (s)

© 2009 Schneider Electric. All Rights Reserved.

Applet ATVConf started Internet

■ Time out

This page can also be used to modify the communication monitoring “time out”. All entries must be confirmed by pressing “Enter”.

The accepted values are as follows:

0: No communication check.

0.5 to 60.0 s: Time out value.

See the “Configuration - Communication faults” section.

The default time out value is 2 s (display: “2.0”).

The “Time Out” field corresponds to the [time out] (**£ D U £**) parameter.

■ Master

See the “Reserving control” section.

To configure reservation, enter an IP address other than [0.0.0.0] in the “Master” field. This field is equivalent to the [IP Master] (**IP -**) parameter.

14. Standard Web server

14. 16. "Email" page

The configuration page of the Email service is available in the setup menu → Email of the option board web page, **only for V2.1 version and above.**

This service is able to generate and send emails to a predefined address in case of alarm warning or drive fault. The controller inside option board can also initiate the sending of an email.

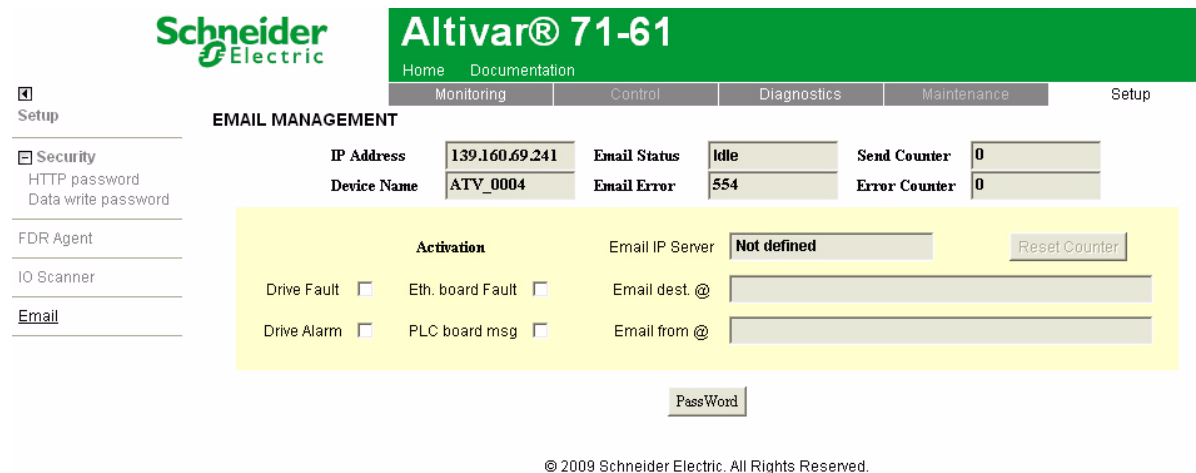

It is possible to configure the Email service after entering the "Write password" (see "HTTP password" and "Data write password pages" section on page 55).

Enter the following information to configure the Email service :

Email IP Server : IP address of the Email server that will process the message (SMTP server)

Email Dest @ : Email address of the Email recipient

Email From @ : Email address of the Ethernet option board which will send the email (this is a virtual address since the option board does not provide any incoming email box)

Configure the triggering mode for sending Email :

Drive Fault : an Email is sent on a drive fault (triggered by ETA.3)

Drive alarm : an Email is sent on a drive warning (triggered by ETA.7)

Eth. Board fault : an Email is sent on an ethernet board fault

PLC Board status : an Email is sent on demand from the application of the controller inside board

Email example sent on CNF fault of the Ethernet board :

```
From: ALTIVAR@pascal.fr
Subject: Error CNF on Altivar Drive
Date: Wed, 14 Dec 2005 14:55:32 +0100

Fault occured on Ethernet Board's Drive:
DeviceName: ATV
IP Address: 139.160.69.241
Reference : ATV71H037M3

Description: TimeOut TCP/Modbus (CNF)

IMPORTANT NOTICE
This Email has been automatically generated. Please do not reply.
Copyright © 2005, Schneider Automation. All rights reserved
```

Service diagnostic :

- Email Status
 - 0 → Idle
 - 1 → Operational
 - 2 → Stopped
- SentCount : number of emails successfully sent
- ErrorCount : number of errors occurred
- LastError : last error code

14. Standard Web server

14. 17. “Documentation” menu

Number of Modbus TCP connections	0
----------------------------------	---

The “Documentation” menu contains a link to the “References” page.
This page displays a link to the site: <http://www.schneider-electric.com/>.

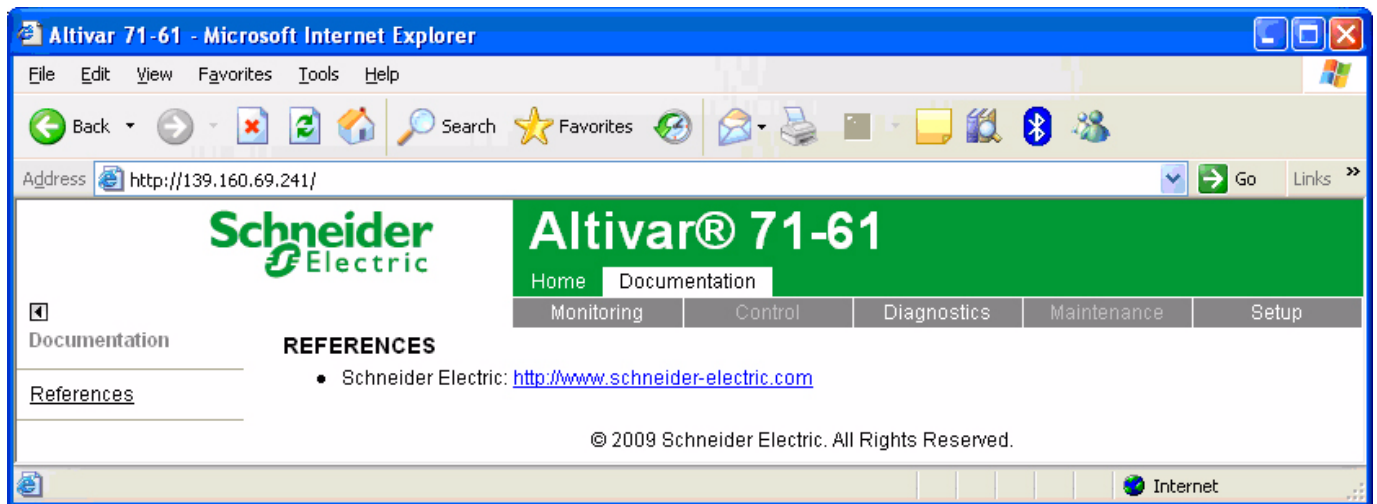

15. FTP server

■ Access

The Ethernet card has a structured FTP server which is used to:

- Access the embedded Web server resource files.
- Store the FDR (Faulty Device Replacement) service configuration files.

Access to the FTP server is protected. To access it, the user has to enter a user name and a password:

- The user name is USER.
- The default HTTP password is USER. It can be changed by the standard Web server.

Address format in Internet Explorer: **ftp://USER:USER@xxx.xxx.xxx.xx.**



With some FTP clients, it is necessary to click “CANCEL” after connecting.

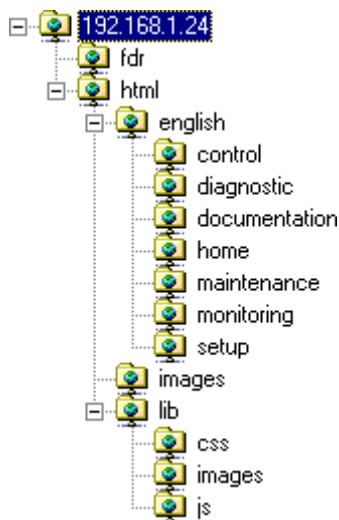

To obtain this display in Internet Explorer, first activate the “Enable folder view for FTP sites” option (in: Tools, Internet Options ..., Advanced, Browsing).

The FTP server accepts up to **2** FTP clients connected at the same time.

The FTP server content cannot be modified if the motor is running.

15. FTP server

■ Functions

The table below describes the functions available:

FTP functionality	Comment
User name check. Accepts or rejects connection	Handled
HTTP password check. Accepts or rejects	Handled
User output	Handled
Type of file system	Handled. "DOS".
Create a volume or disk	Not handled
Change file name	Handled
Delete a file	Handled
Open a file	Handled in read/write mode
Read a file	Handled
Write a file	Handled
Close a file	Handled
Open a directory	Handled
Close a directory	Handled
Change directory	Handled
Current directory = parent directory	Handled
Delete a directory	Handled
Create a directory	Handled
Restore current directory	Handled
Read next directory input	Handled

■ File system

The FTP server "fdr" directory is fixed. The RD (remove directory) command therefore has no effect on this directory. Conversely, the whole "html" directory can be modified using the MD (make directory) and RD commands.

Note: Before modifying the content of this directory, remember to save it to the hard disk of your PC. Do not modify this saved directory because in the event of a problem, you can use it to restore the original content of the FTP server "html" directory.

The file system is DOS type. The response to DIR or LS commands, handled by the tffSOpenDir and tffSGetNextDirEntry functions is as follows:

```
08-28-01 08:07AM      <DIR>          Java
08-28-01 08:07AM          57346      AtvSys.jar
```

This syntax must be strictly adhered to.

The Ethernet card manages the time and date of Web server file save operations.

But there is a specific procedure for starting the Ethernet card date/time function:

- Connect a browser to the standard Web server.
- Open one of the pages containing a Java applet (Altivar Viewer, Data Viewer, Altivar chart, Ethernet Statistics, FDR agent, IO Scanner).
- On each connection, the applet sends the date and time present on the PC on which it is executed.

The date/time function remains active until the end of the day. After midnight, it is automatically deactivated.

Note: If the date/time function has not been activated, the date and time used to date-stamp the Web server files are those supplied by the Ethernet card software.

16. Downloading from the Web server

■ Principle

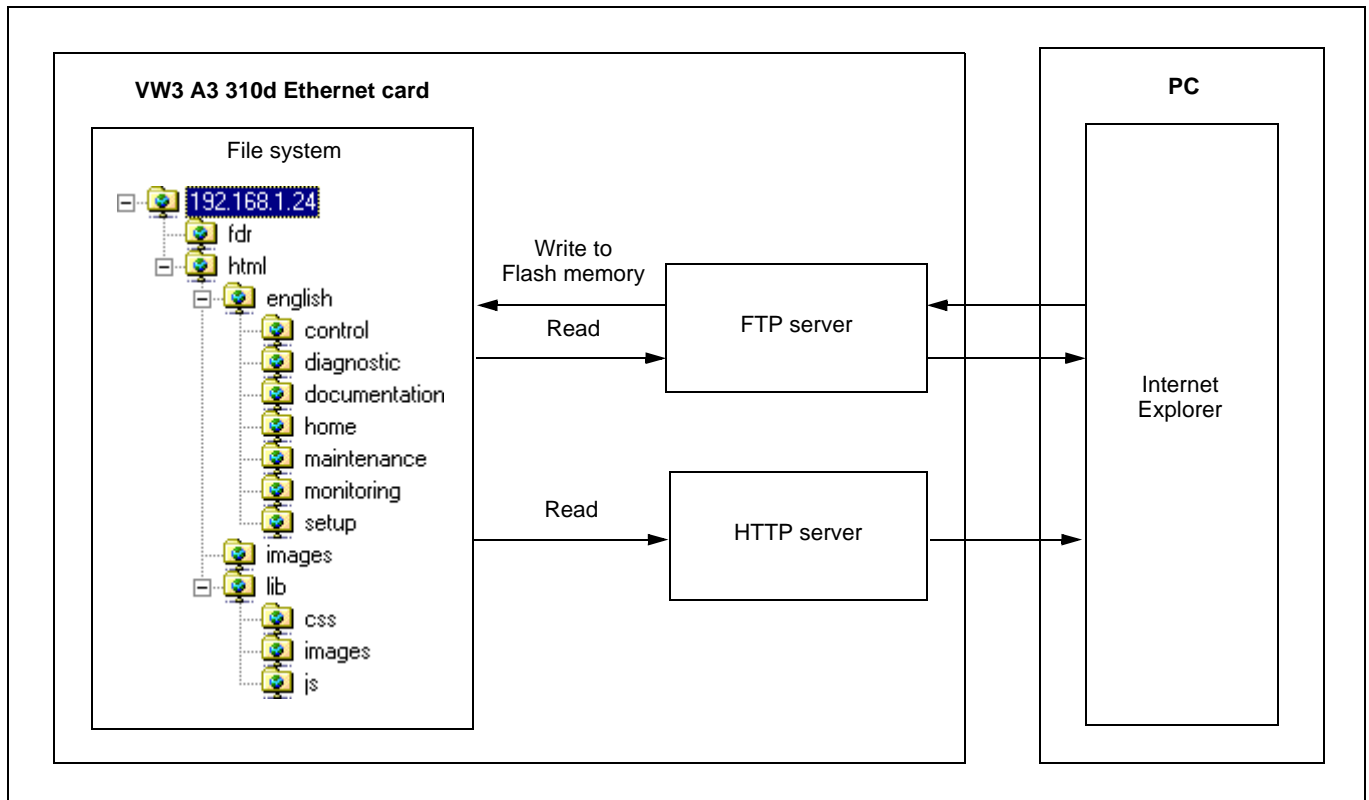

The Ethernet card has an embedded FTP server which authorizes access to the various URLs available for the HTTP server. A browser such as Internet Explorer can be used to display the URLs like a disk in the Windows explorer. This "disk" consists of various directories containing the URL files. It is therefore possible to use the different commands managed by the explorer such as deletion, renaming or writing (downloading) files (check that card IO Scanning has been disabled).

■ File management

The memory zone assigned to the Web server URLs consists of 48 blocks:

- 47 sectors of 64 Kb for file storage.
- 1 sector of 64 Kb for the file table.

The Web server storage capacity is 3.1 Mb, i.e. 3136 Kb.

The file table is used to make the link between the HTTP server, the FTP server and the various "URL" files. This table is dynamic, in other words it changes according to the file write and file delete type user commands. The table is cleared and reprogrammed each time there is a change.

The maximum number of URL files is limited to 150.

The information relating to each file is as follows:

- File name (**32 characters max.**).
- Location address in the card memory.
- File size in bytes.
- "FTP" storage directory (html, html/lib/js etc.).
- URL processing function. (Access management, etc.). All the URLs have a default function which requires a password ("HTTP password") in order to access them via HTTP, apart from a few exceptions (see below).

16. Downloading from the Web server

Each URL in the HTTP server is stored in the file table. As a result, the user can easily change the standard Web server by adding, deleting or modifying the URL files.

However, some URLs are compulsory and/or cannot be modified.

- The "index.htm", "html/english/home/index.htm" and "html/english/home/home.htm" pages, which form the entry page to the Web server, are compulsory.
- The WebServer.htm page (see later), and the various HTML requests, such as password modification, are fixed and are not visible via the FTP server.

The maximum file size is limited to **64 Kb**. The size of the AtvSys.jar java archive file, containing all the java applets, is almost 64 Kb. If additional java applets are required, two archive files must be created.

■ Web server

The Web server has a masked page, which cannot be accessed directly via a hyperlink, providing access to a summary of the memory resources, sector by sector, used by the Web server.

Example of access: <http://192.168.1.23/WebServer.htm>

Memory Sector	Free (bytes)	Max (bytes)	FastFree (bytes)	# File
Sector 20	4294964808	65536	8	15
Sector 21	2402	65536	38	4
Sector 22	6666	65536	42	1
Sector 23	21571	65536	8	2
Sector 24	65472	65536	59	1
Sector 25	46558	65536	12	30
Sector 26	22570	65536	22570	1
Sector 27	39	65536	39	4
Sector 28	4613	65536	4613	3
Sector 29	23081	65536	23081	1
Sector 30	21836	65536	6774	1
Sector 31	23388	65536	23388	1
Sector 32	3	65536	3	11
Sector 33	22884	65536	22884	1
Sector 34	12091	65536	11980	5
Sector 35	1597	65536	1597	2
Sector 36	65536	65536	65536	0
Sector 37	65536	65536	65536	0
Sector 38	65536	65536	65536	0
Sector 39	65536	65536	65536	0
Sector 40	65536	65536	65536	0
Sector 41	65536	65536	65536	0
Sector 42	65536	65536	65536	0
Sector 43	65536	65536	65536	0
Sector 44	65536	65536	65536	0
Sector 45	65536	65536	65536	0
Sector 46	65536	65536	65536	0
Sector 47	65536	65536	65536	0
Sector 48	65536	65536	65536	0
Sector 49	65536	65536	65536	0
Sector 50	65536	65536	65536	0
Sector 51	65536	65536	65536	0
Sector 52	65536	65536	65536	0
Sector 53	65536	65536	65536	0

16. Downloading from the Web server

Memory Sector	Free (bytes)	Max (bytes)	FastFree (bytes)	# File
Sector 54	65536	65536	65536	0
Sector 55	65536	65536	65536	0
Sector 56	65536	65536	65536	0
Sector 57	65536	65536	65536	0
Sector 58	65536	65536	65536	0
Sector 59	65536	65536	65536	0
Sector 60	65536	65536	65536	0
Sector 61	65536	65536	65536	0
Sector 62	65536	65536	65536	0
Sector 63	65536	65536	65536	0
Sector 64	65536	65536	65536	0
Sector 65	65536	65536	65536	0
Sector 66	65536	65536	65536	0
TOTAL	2303899	3080192	2148712	83

16. Downloading from the Web server

■ Standard Web server resources

The Web server is version HTTP 1.1 and also supports HTTP 1.0.

The HTTP server provides access to the resources (URLs) in the Ethernet card:

- HTML pages
- Images
- Java applets
- Text file (Description of the drive parameters)

Type	File name (Complete URL)	Size (bytes)	Type	File name (Complete URL)	Size (bytes)
HTML pages	AtvChart.htm	651	Special HTML pages	WebServer.htm	-
	AtvConf.htm	630		Access not permitted	-
	AtvFdr.htm	628		Pwd change OK	-
	AtvView.htm	880		Pwd change NOK	-
	DataEditor.htm	633	Parameter file	fdr/Current.prm	Variable
	DocReferences.htm	660	Images	altivar71.jpg	14,982
	index.htm	591		images/SchneiderElectric.gif	3,582
	SecurityData.htm	1,570		images/SchneiderElectricPocket PC.gif	3,216
	SecurityHttp.htm	1,523		lib/images/left.gif	870
	Statistic.htm	648		lib/images/moins.gif	866
	html/english/header.htm	968		lib/images/plus.gif	883
	html/english/index.htm	560		lib/images/right.gif	882
	html/english/control/index.htm	575	Java applets	AtvChart.jar	15,479
	html/english/control/menu.htm	760		AtvSys.jar	64,736
	html/english/monitoring/index.htm	575	Text file	DataFile.txt	42,196
	html/english/monitoring/menu.htm	856	JavaScript scripts	html/config.js	418
	html/english/documentation/index.htm	575		lib/js/header.js	5,629
	html/english/documentation/menu.htm	839		lib/js/home.js	536
	html/english/home/home.htm	698		lib/js/index.js	895
	html/english/home/index.htm	575		lib/js/menu.js	4,824
	html/english/home/menu.htm	830		lib/js/tools.js	261
	html/english/maintenance/index.htm	575		Cascaded Style Sheets	main.css
	html/english/maintenance/menu.htm	64	lib/css/header.css		988
	html/english/monitoring/index.htm	575	lib/css/main.css		341
	html/english/monitoring/menu.htm	960	lib/css/menu.css		655
	html/english/setup/index.htm	575			
	html/english/setup/menu.htm	1,056			

The total size is 176,426 bytes for a total of 47 files (excluding special HTML pages and parameters file).

The standard Web server HTML pages have been designed for a 1024 × 768 minimum screen resolution.

17. SNMP agent

■ Presentation

The SNMP protocol (Simple Network Management Protocol) is used to provide the data and services required for managing a network.

The data is stored in an MIB (Management Information Base).
The SNMP protocol is used to read or write MIB data.

Implementation of the Ethernet card SNMP services is minimal, as only the compulsory objects are handled.

Note: An SNMP agent can be configured to generate TRAPS to the SNMP Manager.
TRAPS are used to signal a specific agent state (fault, reset, etc.).
The VW3 A3 310d Ethernet card does not handle TRAPS.

■ Tree structure

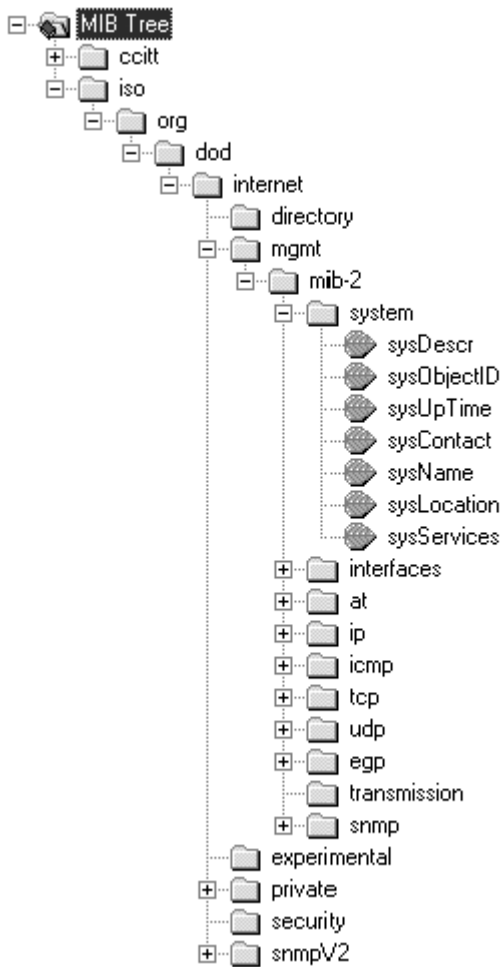

17. SNMP agent

■ Objects handled

Objects	Description	Access	Default value
SysDescr	Text description of the device	R	SCHNEIDER ATV Altivar Fast Ethernet TCP/IP Module
SysObjectID	Pointer to the product reference in the private MIB	R	entreprises.3833.1.7.255.6
SysUpTime	Time elapsed since the Ethernet card was last turned on	R	-
SysContact	Data item used to contact the manager of this node	R/W	-
SysName	Node administrative name	R/W	ATV
SysLocation	Physical location of the product	R/W	-
SysService	Indicates the type of service offered by this product	R	72

The SysContact, SysName and SysLocation objects can be modified by the user. The values written are saved to the Ethernet card via an SNMP client not supplied with the VW3 A3 310d Ethernet card.

The size of these character strings is limited to **50** characters.

Using the “public” character string as a “community string” allows the user to access objects in read mode (all objects), whereas the “schneider” character string enables read access (all objects) and write access (R/W objects only) to the string.

18. Setup using PL7

■ Defining the hardware configuration

Configure an Ethernet module, then configure the module so that it can communicate with the drive. The example shows a TSX Premium PLC equipped with a TSX ETY5102 module.

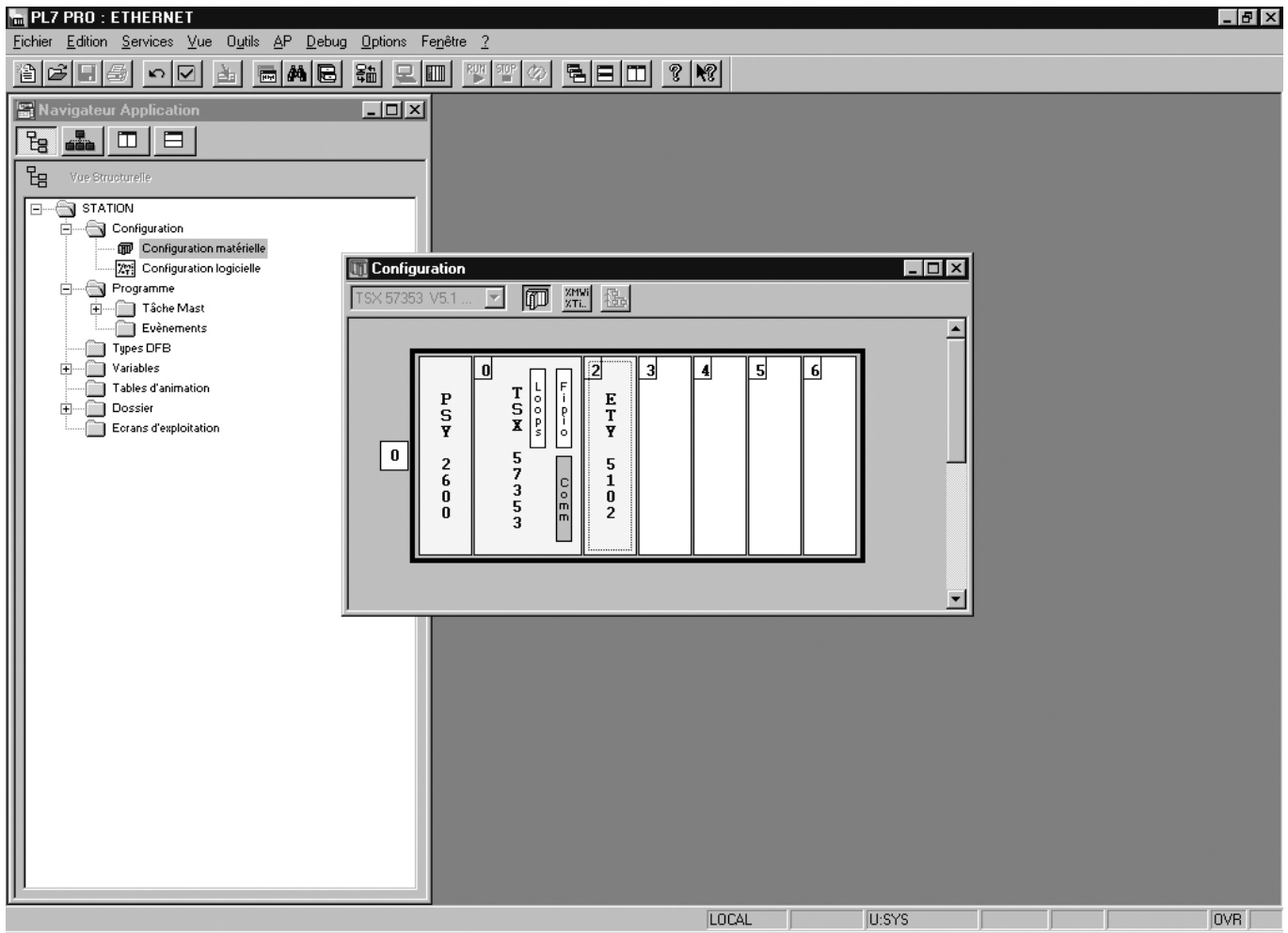

18. Setup using PL7

■ BOOTP configuration

The BOOTP server function consists of allocating BOOTP clients their IP addresses.

The activation conditions for the drive BOOTP client are described in the “Configuration - IP Addresses” section.

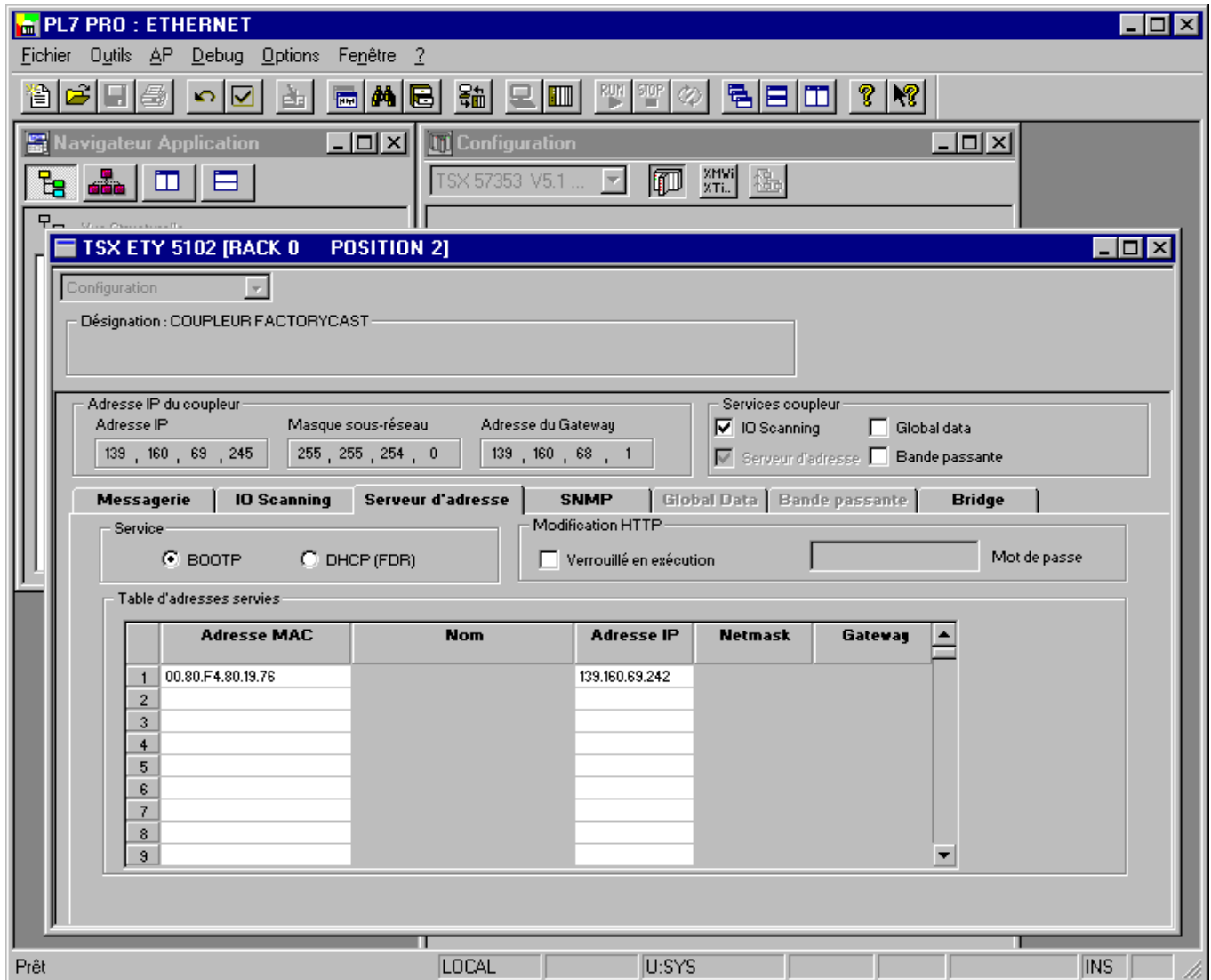

This window is used to configure the BOOTP server.

The drive MAC address is given on a label attached to its VW3 A3 310d Ethernet card. The IP address assigned to the drive must be entered in the table against the MAC address.

In this example, the Ethernet card MAC address is 00.80.F4.80.19.76, and its IP address is 139.160.69.242.

Each line in the “Table of supplied addresses” can accept both the MAC and IP addresses of a BOOTP client.

18. Setup using PL7

■ Configuring Modbus messaging

To use Modbus messaging in PL7, the “IP address”, “Subnet mask” and “Gateway address” parameters must be configured in the “Messaging” tab in the PLC Ethernet module configuration screen.

Data entered in the “Connection configuration” box is used to manage the PLC Modbus messaging service, but has no effect on IO Scanning which is an independent service.

Example:

PLC IP address	139.160.69.245
Subnet mask	255.255.254.0
Gateway address	139.160.68.1
Drive IP address	139.160.69.242

	Xway address	IP address	Protocol	Access	Mode
1	1.101	139.160.69.242	MODBUS	<input checked="" type="checkbox"/>	MULTI

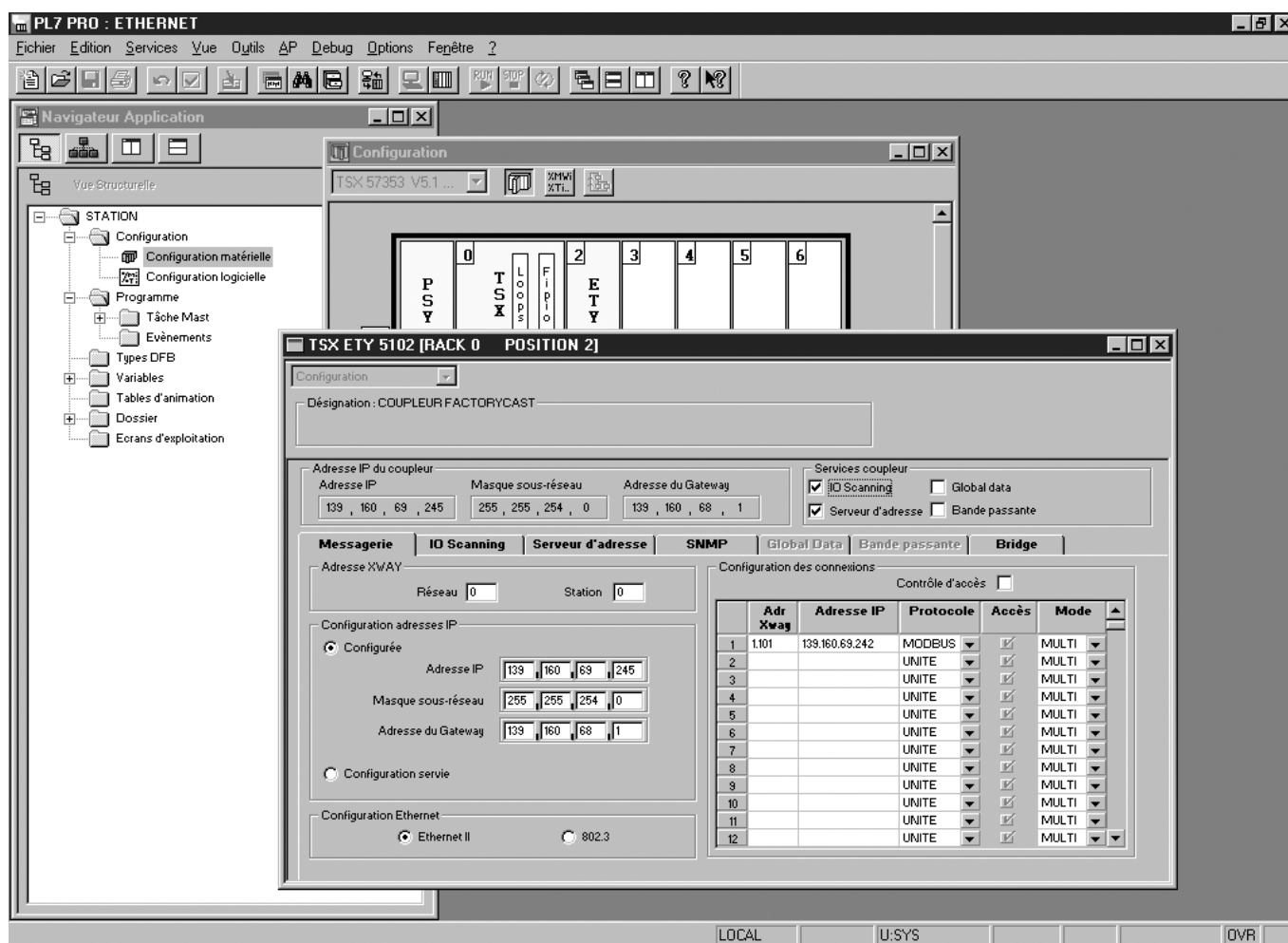

18. Setup using PL7

■ Configuring periodic variables

This window is used to configure the IO Scanning function, described in the IO Scanning Service section on page 40. In this example:

- The periodic variables of the drive at IP address 139.160.69.242 are associated with PLC data words.
- The drive periodic output variables (control) are associated with the 32 words (WR count) starting at PLC address %MW550 (Write Ref.).
- The drive periodic input variables (monitoring) are associated with the 32 words (RD count) starting at PLC address %MW500 (Read Ref.).

The screenshot shows the 'Configuration' window for a 'TSX ETY 5102 [RACK 0 POSITION 2]' drive. The 'IO Scanning' tab is selected, displaying the following configuration details:

- Services coupleur:** IO Scanning, Global data, Serveur d'adresse, Bande passante
- Repli des entrées:** Repli à 0, Maintien
- Réglage de la scrutation (ms):** Slow: 150, Normal: 30, Fast: 10
- Zones %MW du master:** Read Ref. De 500 à 531, Write Ref. De 550 à 581

The 'Périphériques scannés' table is as follows:

	Adresse IP	Unit ID	Repetitive rate	RD ref. master	RD ref. slave	RD count	VR ref. master	VR ref. slave	VR count	Description
1	139.160.69.242	255	NORMAL	500	0	32	550	0	32	
2			NONE							
3			NONE							
4			NONE							
5			NONE							
6			NONE							
7			NONE							
8			NONE							

18. Setup using PL7

The addresses for the PLC %MW words correspond to the configuration in the previous example.

PLC address	Periodic output variable (default assignment)	Configurable
%MW 550	Reserved	no
%MW 551	Control word (CMd)	yes
%MW 552	Speed setpoint (LFrd)	yes
%MW 553	Not assigned	yes
%MW 554	Not assigned	yes
%MW 555	Not assigned	yes
%MW 556	Not assigned	yes
%MW 557	Not assigned	yes
%MW 558	Not assigned	yes
%MW 559	Not assigned	yes
%MW 560	Not assigned	yes
%MW 561 to %MW 581	Reserved	no

PLC address	Periodic input variable (default assignment)	Configurable
%MW 500	Reserved	no
%MW 501	Status word (EtA)	yes
%MW 502	Output speed (rFrd)	yes
%MW 503	Not assigned	yes
%MW 504	Not assigned	yes
%MW 505	Not assigned	yes
%MW 506	Not assigned	yes
%MW 507	Not assigned	yes
%MW 508	Not assigned	yes
%MW 509	Not assigned	yes
%MW 510	Not assigned	yes
%MW 511 to %MW 531	Reserved	no

18. Setup using PL7

■ Configuring the DHCP address server (FDR)

The DHCP server function consists of allocating BOOTP clients an IP address.

The activation conditions for the drive DHCP (FDR) client are described in the “Configuration - IP Addresses” section.

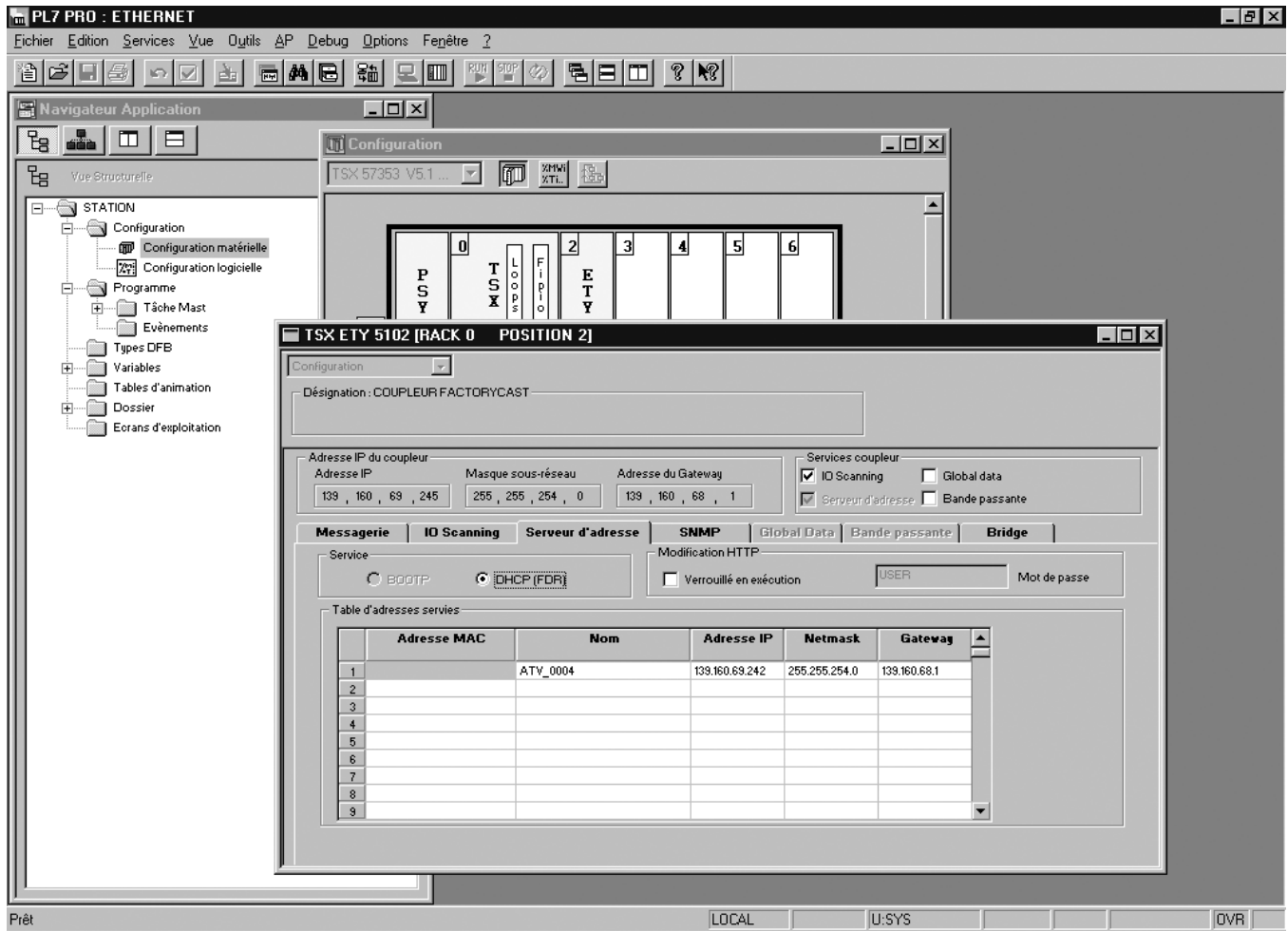

This window is used to configure the DHCP server.

The user must enter the following fields:

- “Name” to indicate the device name. In our example the ATV name is “ATV_0004”. This “name” corresponds to the FDR function DeviceName and the drive parameter [DEVICE NAME].
- “IP address” to indicate the device IP address. In our example the ATV IP address is “139.160.69.242”.
- “Netmask” to indicate the subnet mask. In our example the subnet mask is “255.255.254.0”.
- “Gateway” to indicate the gateway IP address. In our example the gateway IP address is “139.160.68.1”.

Each line in the “Table of supplied addresses” can accept both the names and IP addresses of a DHCP client.

19. Setup using Concept

■ Hardware configuration

Drop
 Modules: 4 Bits In: 16 Bits Out: 8
 Status Table: ASCII Port #: none
 Clear Prev Next

Module
 Bits In: 0 Bits Out: 0
 Delete Params
 Cut Copy Paste

Rack-Slot	Module	Detected	In Ref	In End	Out Ref	Out End	Descr
1-1	CPS-124-00						AC PS 115/230V RED
1-2	CPU-434-12						CPU 2MB 1xMB+ 2xMB
1-3	NOE-771-00						ENET 10/100 TCP/IP
1-4	DAM-590-00		100001	100016	000001	000008	AC IN/OUT 115V 16/8
1-5	...						
1-6	...						
1-7	...						
1-8	...						
1-9	...						
1-10	...						
1-11	...						
1-12	...						
1-13	...						
1-14	...						
1-15	...						

OK Cancel Help Poll

Edit drop configuration NOT CONNECTED

■ Ethernet and I/O Scanner configuration

The screen illustrated below does not apply to the 140-NOE-771-10 master module.

Ethernet Configuration:
 Specify IP Address Internet Address: 139.160.69.245 Subnet Mask: 255.255.254.0
 Use Bootp Server Gateway: 139.160.68.1 Frame Type: ETHERNET II
 Disable Ethernet

I/O Scanner Configuration:
 Master Module (Slot): Slot 3: 140-NOE-771-00
 Health Block (1x/3x): 300010
 Copy Cut Paste
 Delete Sort Fill Down

	Slave IP Address	Unit ID	Health Timeout	Rep Rate	Read Ref Master	Read Ref Slave	Read Length	Write Ref Master	Write Ref Slave	Write Length	Description
1	139.160.69.242	255	2000	10	400100	400001	32	400500	400001	32	ATV71
2											
3											
4											
5											
6											
7											
8											
9											
10											
11											
12											
13											
14											
15											
16											
17											
18											
19											
20											
21											
22											
23											
24											

OK Cancel Help

20. Setup using ProWORX NxT

■ Hardware configuration (Traffic Cop)

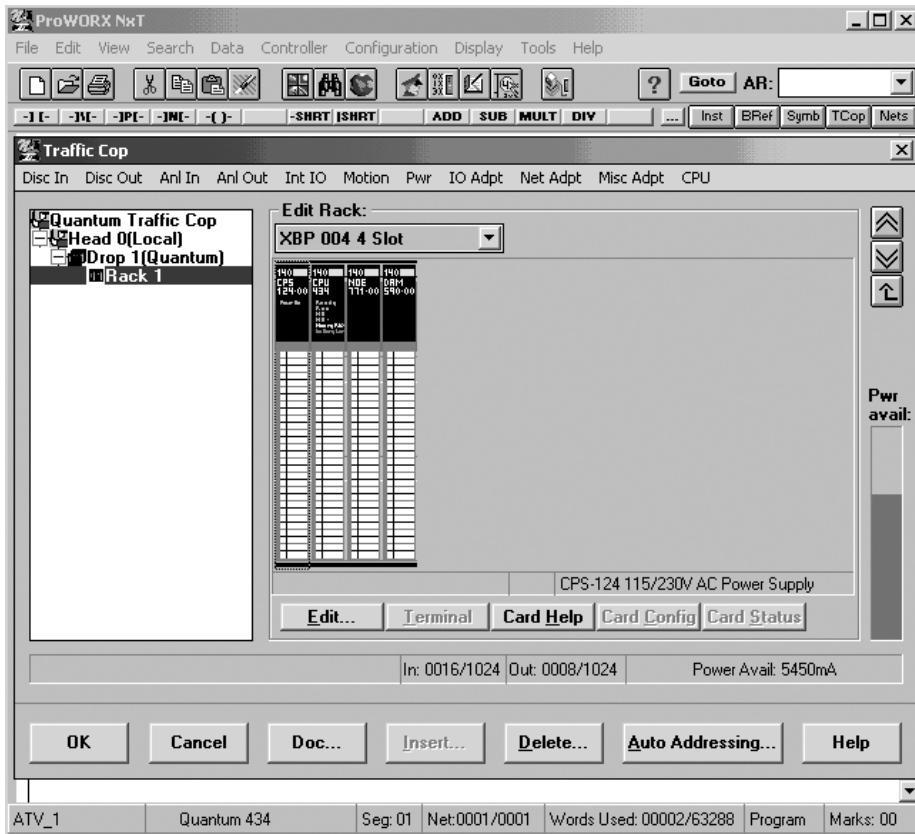

■ Network configuration

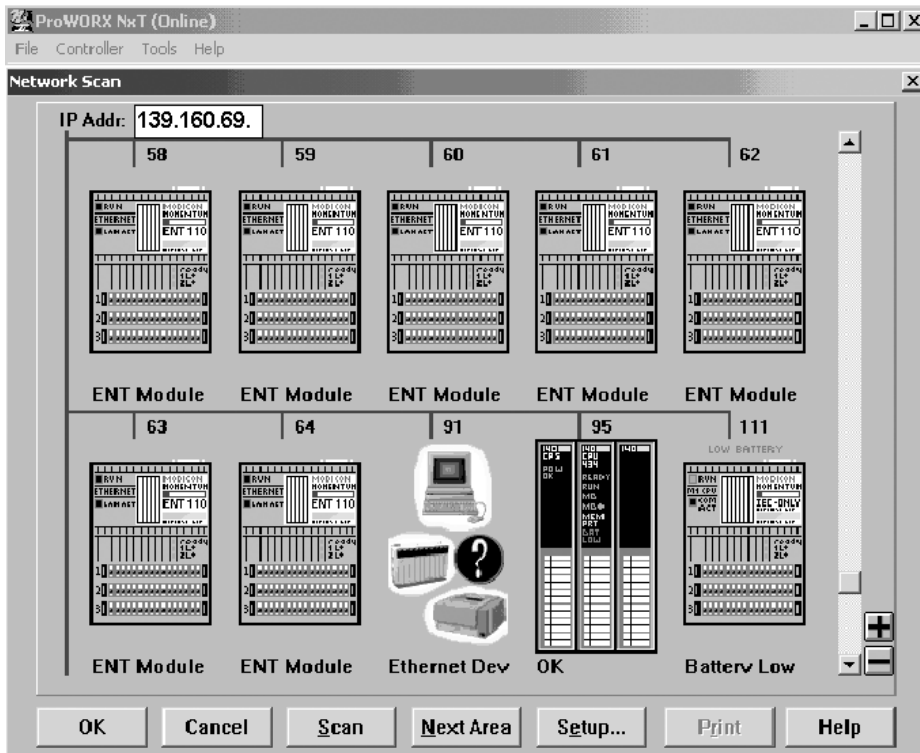

20. Setup using ProWORX NxT

■ TCP/IP configuration

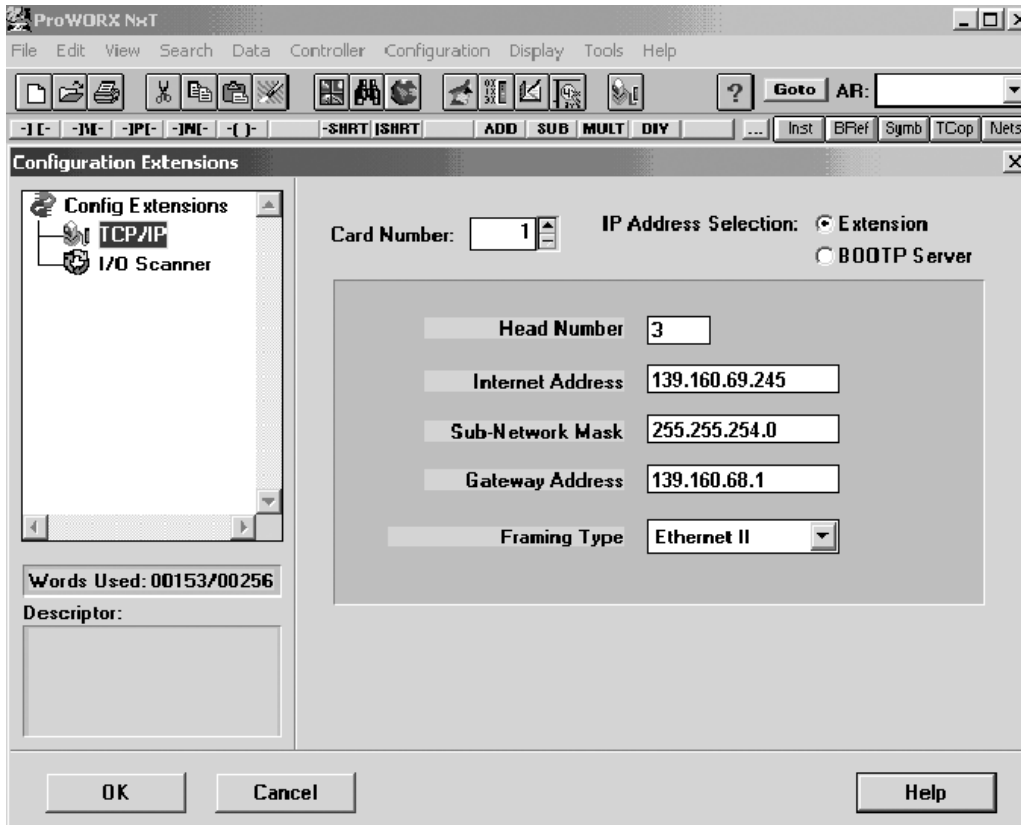

■ I/O Scanner configuration

