

Modular PLCs XControl:
XC-104-...
XC-204-...
XC-303-...



Powering Business Worldwide

All proprietary names and product designations are brand names or trademarks registered to the relevant title holders.

Service

For service and support, please contact your local sales organisation.

Contact details: [Eaton.com/contacts](https://www.eaton.com/contacts)

Service page: [Eaton.com/aftersales](https://www.eaton.com/aftersales)

For customers in US/Canada contact:

EatonCare Customer Support Center

Call the EatonCare Support Center if you need assistance with placing an order, stock availability or proof of shipment, expediting an existing order, emergency shipments, product price information, returns other than warranty returns, and information on local distributors or sales offices.

Voice: 877-ETN-CARE (386-2273) (8:00 a.m. – 6:00 p.m. EST)

After-Hours Emergency: 800-543-7038 (6:00 p.m. – 8:00 a.m. EST)

Drives Technical Resource Center

Voice: 877-ETN-CARE (386-2273) option 2, option 6

(8:00 a.m. – 5:00 p.m. Central Time U.S. [UTC-6])

email: TRCDrives@Eaton.com

www.eaton.com/drives

Original operating manual

The German-language edition of this document is the original operating manual.

Translation of the original operating manual

All editions of this document other than those in German language are translations of the original operating manual.

1. edition 2018, publication date 02/18

2. edition 2023, publication date 01/23

© 2018 by Eaton Industries GmbH, 53105 Bonn

Author: Thomas Hettwer

Redaction: Bettina Ewoti, Antje Panten-Nonnen

All rights reserved, also for the translation.

No part of this manual may be reproduced, stored in a retrieval system, or transmitted in any form or by any means, electronic, mechanical, photocopying, micro-filming, recording or otherwise, without the prior written permission of Eaton Industries GmbH, Bonn.

Subject to alteration.



Danger! **Dangerous electrical voltage!**

Before commencing the installation

- Disconnect the power supply of the device.
- Ensure that devices cannot be accidentally retriggered.
- Verify isolation from the supply.
- Ground and short-circuit.
- Cover or enclose neighbouring units that are live.
- Follow the engineering instructions (IL) of the device concerned.
- Only suitably qualified personnel in accordance with EN 50110-1/-2 (VDE 0105 Part 100) may work on this device/system.
- Before installation and before touching the device ensure that you are free of electrostatic charge.
- The functional earth (FE) must be connected to the protective earth (PE) or to the potential equalizing. The system installer is responsible for implementing this connection.
- Connecting cables and signal lines should be installed so that inductive or capacitive interference do not impair the automation functions.
- Install automation devices and related operating elements in such a way that they are well protected against unintentional operation.
- Suitable safety hardware and software measures should be implemented for the I/O connection so that a cable or wire breakage on the signal side does not result in undefined states in the automation device.
- Ensure a reliable electrical isolation of the low voltage for the 24 V supply. Only use power supply units complying with IEC 60364-4-41 or HD 384.4.41 S2 (VDE 0100 part 410).
- Deviations of the mains voltage from the nominal value must not exceed the tolerance limits given in the technical data, otherwise this may cause malfunction and dangerous operation.
- Emergency-Stop devices complying with IEC/EN 60204-1 must be effective in all operating modes of the automation devices. Unlatching the emergency switching off devices must not cause restart.
- Built-in devices for enclosures or cabinets must only be run and operated in an installed state, desk-top devices or portable devices only when the housing is closed.
- Measures should be taken to ensure the proper restart of programs interrupted after a voltage dip or failure. This should not cause dangerous operating states even for a short time. If necessary, emergency switching off devices should be implemented.
- Wherever faults in the automation system may cause damage to persons or property, external measures must be implemented to ensure a safe operating state in the event of a fault or malfunction (for example, by means of separate limit switches, mechanical interlocks, etc.).
- During operation, and depending on their degree of protection, variable frequency drives may have live, uninsulated, moving, and/or rotating parts, as well as hot surfaces.
- The impermissible removal of the required cover, improper installation or incorrect operation of the motor or variable frequency drive can cause the failure of the device and serious injury and/or material damage.
- Comply with all applicable national accident prevention regulations (e.g. BGV A3) when working with energized variable frequency drives.
- The electrical installation must be carried out in accordance with the relevant regulations (e.g. with regard to cable cross sections, fuses, PE).
- All transport, installation, commissioning and maintenance work must only be carried out by trained personnel (observe IEC 60364, HD 384 or DIN VDE 0100 and national accident prevention regulations).
- If applicable, systems in which variable frequency drives are installed must be equipped with additional monitoring and protective devices in accordance with the applicable safety regulations, e.g., the German Equipment and Product Safety Act, accident prevention regulations, etc. Making changes to the variable frequency drives by using the operating software is allowed.
- Keep all covers and doors closed during operation.
- When designing the machine, the user must incorporate mechanisms and measures that limit the consequences of a drive controller malfunction or failure (an increase in motor speed or the motor's sudden stop) so as to prevent hazards to people and property, e.g.:
 - Additional stand-alone devices for monitoring parameters that are relevant to safety (speed, travel, end positions, etc.)
 - Electrical and non-electrical safety devices (interlocks or mechanical locks) for mechanisms that protect the entire system
 - Due to the possibility of there being capacitors that are still holding a charge, do not touch live device parts or terminals immediately after disconnecting the variable frequency drives from the supply voltage. Heed the corresponding labels on the variable frequency drives

Content

0	About this manual	7
0.1	Target group.....	7
0.2	List of revisions	8
0.3	Additional documentation	8
0.4	Legal disclaimer	9
0.5	I/O system XN300.....	9
0.6	Writing conventions	10
1	Description of the Modular PLCs XControl: XC-104-..., XC-204-..., XC-303-...	11
1.1	System overview	11
1.2	Communications and interfaces - decentralized expansion	12
1.3	Intended use	12
1.4	Versions	14
1.4.1	XC-104-... and XC-204-...	14
1.4.2	XC-303-...	15
1.5	Key to XControl part numbers.....	17
1.5.1	Device Version Number	17
1.6	Functionality	18
1.6.1	Power Supply	18
1.6.2	Local inputs/outputs.....	18
1.6.3	Processor unit	18
1.6.4	Device interfaces	21
2	Installation	31
2.1	Control panel layout	31
2.1.1	ventilation.....	31
2.2	Mounting XControl	32
2.3	Uninstalling and disassembly (using the XControl as an example)	36
2.4	Connection terminals	38
2.5	Potential relationship between the components	39
2.6	Wiring in accordance with EMC requirements	40
2.6.1	Cable routing and wiring	42
2.6.2	Suppressor circuit for interference sources	42
2.6.3	Screen earth kit	42
2.7	Lighting protection	42
2.7.1	External lightning protection	42
2.7.2	Internal lightning protection	43
2.8	Connecting the power supply	44
2.8.1	XC-303-... power supply	44
2.8.2	XC-104-..., XC-204-... power supply	44

2.9	Connecting local inputs/outputs.....	46
2.9.1	Connecting the power supply for local outputs on XC-303-.....	46
2.9.2	Connecting outputs.....	47
2.9.3	Suppressor circuit for inductive loads.....	48
2.9.4	Connecting inputs.....	48
2.9.5	Using inputs as interrupt inputs.....	51
3	Commissioning	53
3.1	General commissioning instructions.....	53
3.2	USB interface activation for XC-104-... and XC-204-... devices...	53
3.3	Startup behavior XC-104-..., XC-204-..., XControl.....	56
3.4	Program execution.....	58
3.4.1	DIP switch S1	58
3.4.2	DIP switch S2	59
3.4.3	Program start (STOP → RUN).....	59
3.4.4	Program stop (RUN → STOP).....	59
3.5	Power off/Interruption of the power supply.....	60
3.5.1	Test and commissioning (Debugging).....	60
3.5.2	Forcing.....	61
3.5.3	Reset	62
3.6	LED indicators.....	63
3.7	Operating states when the XControl starts	65
3.8	Programs and project.....	66
3.8.1	Loading programs onto the device	66
3.8.2	Saving and deleting a boot application.....	67
3.9	Updating the operating system.....	68
3.9.1	Updating the operating system with the Web Config Tool.....	68
3.9.2	Updating the operating system with the XSOFT-CODESYS-3 programming system.....	68
3.10	Factory resetting XC-104-... and XC-204-.....	71
3.11	Mass production programming through MicroSD or USB.....	72
3.12	XN300-Assist	72
4	PLC configuration	73
4.1	Task configuration.....	73
4.1.1	Creating a cyclical task.....	74
4.1.2	Creating the event-triggered task and defining the program call.	75
4.2	System events.....	76
4.3	Multi-tasking	77
4.4	Task monitoring by watchdog.....	79
4.5	Limit values for memory usage	83
4.6	Addressing inputs/outputs and marker.....	84
4.7	Diagnostics	85
4.8	Factory reset.....	87

4.8.1	Resetting the device to factory settings	87
5	Connection set-up PC – Modular PLCs XControl: XC-104-..., XC-204-..., XC-303-...	89
5.1	Network search with automatic PLC detection	89
5.2	Creating a new project	90
5.3	Changing the IP address on the PLC	91
6	In-/output configuration and parameterization	93
6.1	Configuring the device's local inputs/outputs	93
6.2	Interrupt processing	94
7	Defining system parameters	99
7.1	Overview	99
7.2	InitPLC file with default parameters	99
7.3	Switch-on of the control with inserted memory card with InitPLC file 101	
7.4	networkconfig file	102
8	Expansion	105
8.1	Local expansion	105
8.1.1	Configuring the inputs/outputs for local expansions	106
8.2	Remote expansion	108
9	CAN	109
9.1	Configuring and commissioning CANopen	110
9.1.1	Adding the CAN manager	111
9.1.2	Setting the baud rate via CANbus	112
9.1.3	Incorporating the CAN-Gateway XN-312-GW-CAN	113
9.1.4	Attach XN300 slice modules	113
9.1.5	Description files for CANopen	115
9.1.6	Adding CANopen communication libraries	116
9.1.7	LEDs on the device	116
10	EtherCAT	117
10.1	Incorporating the EtherCAT master	117
10.2	Configuring the EtherCAT master	118
10.3	Searching for and incorporating EtherCAT modules	119
10.4	Incorporating EtherCAT modules manually	120
10.5	Add SWD module	121
10.6	Description files for EtherCAT	122
10.6.1	Standard XML files	122
10.6.2	Installing the XML file	123
10.6.3	Adding EtherCAT communication libraries	123

11	Modbus.....	125
11.1	Configuring Modbus TCP.....	125
11.2	Adding an Ethernet adapter.....	125
11.3	Adding a Modbus TCP master and device.....	125
11.4	Adding ModbusTCP communication libraries.....	127
11.5	Configuring Modbus RTU.....	128
11.6	Adding a Modbus master.....	128
11.7	Adding Modbus modules.....	128
11.8	Adding libraries for Modbus RTU communication.....	129
12	Remotely accessing the PLC.....	131
13	Web Visu XSOFT-CODESYS-3.....	133
13.1	Opening XSOFT-CODESYS-3 WebVisu.....	133
13.2	Selecting the XSOFT-CODESYS-3 WebVisu encryption type.....	133
14	Web Config Tool for XC-104-... and XC-204-...	135
14.1	Logging in to the Web Config Tool.....	135
14.2	Navigation.....	137
14.3	Setting a language.....	138
14.4	Device configuration page – System configuration page.....	139
14.4.1	Device information.....	140
14.4.2	Changing / setting up passwords.....	140
14.4.3	USB interface activation.....	141
14.4.4	Power management.....	142
14.4.5	Factory reset.....	142
14.4.6	Powerfail.....	143
14.5	Network configuration page.....	143
14.6	Update configuration page.....	145
14.7	Date & time configuration page.....	147
14.7.1	Date & Time.....	147
14.7.2	Time synchronization with NTP.....	147
14.8	Remote access configuration page.....	148
14.8.1	SSH.....	148
14.8.2	VNC.....	148
14.9	Legal configuration page.....	149
14.10	Logs configuration page.....	149
15	OPC UA.....	151
16	Libraries, function blocks and functions.....	152
16.1	Using libraries.....	153
16.2	Installing additional system libraries.....	153

16.3	EA_Network.lib library	155
17	PLC shell commands	157
17.1	Using PLC shell commands	157
17.2	List of PLC shell commands (updated)	158
17.3	CPU load shell commands	162
18	Interferences	163
19	Maintenance	165
19.1	Cleaning and maintenance	165
19.2	Repairs	165
19.3	Storage and transport.....	165
19.4	Disposal.....	166
20	Appendix	169
20.1	Dimensions and weights.....	169
20.1.1	XC-303-.....	169
20.1.2	XC-104-..., XC-204-.....	170
20.2	Approvals and national approvals	171
20.3	Technical specifications	172
20.3.1	General ambient conditions	172
20.3.2	Power supply on devices and on system bus.....	175
20.3.3	Power supply for local inputs/outputs on XC-204-..., XC-303-... ..	176
20.3.4	Local inputs XC-204-..., XC-303-.....	177
20.3.5	Local outputs XC-204-..., XC-303-.....	178
20.3.6	CAN interfaces XC-204-..., XC-303-.....	179
20.3.7	RS485-Interface	181
20.4	Glossary	182
	Index	183

0 About this manual

This manual provides information on the XControl series of modular PLCs. The corresponding product groups consist of the following models:

XControl		
XC-104-...	XC-204-...	XC-303-...
XC-104-C10-000	XC-204-C10-000	XC-303-C32-002
	XC-204-C11-003	XC-303-C21-001
	XC-204-C21-001	XC-303-C11-000
	XC-204-C20-002	



Abbreviated MFD-Titan and XControl designations

This manual uses abbreviated designations whenever it is referring to all models.

Whenever it needs to refer to a specific model instead, it will explicitly indicate the model.

Make sure to always use the latest documentation for the Modular PLCs XControl: XC-104-..., XC-204-..., XC-303-....

The latest version of this documentation, as well as additional references, is available for download on the Internet, see also

→ Section "0.3 Additional documentation", page 8



For the latest information on Modular PLCs XControl: XC-104-..., XC-204-..., XC-303-..., please visit our product pages:

www.eaton.eu/xc300

and the Eaton Online Catalog:

<http://www.eaton.eu/ecat>

Enter "XC300" into the search box and the catalog will take you directly to the corresponding product group.

0.1 Target group

This manual is intended for electricians, electrical engineers, and automation experts, as well as for the people who will be in charge of performing the electrical installation and people who will be using the Modular PLCs XControl: XC-104-..., XC-204-..., XC-303-... as integrated controllers in their own applications.

0 About this manual

0.2 List of revisions

Electrical engineering and physics-related knowledge and skills, as well as advanced familiarity with the communication interfaces and methods being used, will be required in order to be able to commission the devices.



CAUTION

Installation requires qualified electrician

0.2 List of revisions

The following table lists all major changes.

Publication date	Page	Keyword	New	Modifica- tion	Deleted
11/17		New edition	✓		
02/18		Corrections and additions		✓	
01/23		XControl added to all sections	✓		

0.3 Additional documentation

Please follow the safety instructions in the "Eaton Product Secure Configuration Guidelines XC-104-..., XC-204-..." and "Secure Configuration Guidelines XC-303-..." documents and observe the "EULA XC-104-..., XC-204-..." and "EULA XC-303-..." end-user license agreements.

More information on the topic can be found

in the following manual:

- "XN300 slice modules", MN050002
- „CANopen Gateway XN-312-GW-CAN“, MN050003
- „EtherCAT Gateway XN-312-GW-EC“, MN050010
- Manufacturer documentation for XSOFT-CODESYS-3, online help for the individual libraries
- Documentation for the CAN modules used
- PLC programming with CODESYS manual, Chapter "Online functions",

in the following instruction leaflets:

- IL050018ZU, XC-303-...
- IL050031ZU, XControl

in the following supplement, which describes how to activate the device's USB interface:

- MZ0500017ZU



The documents specified in this manual, as well as the manual you are reading right now, can also be downloaded free of charge from the Internet in PDF format at:
Eaton.com/documentation

→ **Customer support** → **Download Center – Documenta-
tion**

Enter the document number ("MN050005", for example), "XControl" or "XC300" into the **Quick Search** text field.

or

on the Modular PLCs XControl: XC-104-..., XC-204-..., XC-303-... product pages:

www.eaton.eu/xc300

0.4 Legal disclaimer

All the information in this manual has been prepared to the best of our knowledge and in accordance with the state of the art. However, this does not exclude the possibility of there being errors or inaccuracies. We assume no liability for the correctness and completeness of this information. In particular, this information does not guarantee any particular properties.

Do not use the Modular PLCs XControl: XC-104-..., XC-204-..., XC-303-... before reading and understanding this manual.

It is assumed that the user of this document is thoroughly familiar with the information found in the manuals for incorporating XControl modular PLCs into automation processes.

Hazards posed by the XControl modular PLCs cannot be eliminated if the safety instructions are not observed – especially if the XControl modular PLCs is commissioned and maintained by unqualified personnel and/or the XControl modular PLCs is used improperly. Eaton assumes no liability for any damages resulting from cases such as these.

0.5 I/O system XN300

The ultra-compact XN300 modular slice card I/O system, which features a plug-in connection system, complements Modular PLCs XControl: XC-104-..., XC-204-..., XC-303-... with application-oriented functions that are ideal for optimized system solutions.

There are XN300 slice modules available for power distribution and power supply needs, as well as digital and analog I/O modules and technology modules.



For the latest information on the I/O system XN300, please visit our product pages:

www.eaton.eu/xn300

and use the Eaton Online Catalog for information on the available range of products:

<http://www.eaton.eu/ecat>

Enter "XN300" into the search box and the catalog will take you directly to the corresponding product group.

The "XN300 slice modules" manual describes all modules.

0.6 Writing conventions

Symbols with the following meaning are used in this manual:

- ▶ Indicates instructions to be followed.

Hazard warnings of material damages

ATTENTION

Warns about the possibility of material damage.

Hazard warnings of personal injury



CAUTION

Warns of the possibility of hazardous situations that may possibly cause slight injury.



WARNING

Warns of the possibility of hazardous situations that could result in serious injury or even death.



DANGER

Warns of hazardous situations that result in serious injury or death.

Notes



Indicates useful tips.

- ▶ Indicates instructions to be followed

1 Description of the Modular PLCs XControl: XC-104-..., XC-204-..., XC-303-...

1.1 System overview

XC-104-...

The XC100 is the perfect choice for solving simple automation tasks with system-based networking. It can be expanded with up to six snap-on I/O modules from the XN300 system, providing flexibility with regard to system configurations. The device is ideal for implementing small control functions and networking them with higher levels.

XC-204-...

XC200 PLC models can be used to flexibly solve standard automation tasks. The local I/O level can be expanded with up to 16 XN300 I/O modules, while the Ethernet ports make integration into higher levels and networking with Industrial Ethernet easy. The standard interfaces (CAN and RS-485) make it possible to integrate third-party devices and can be used for networking in field bus systems.

XC-303-...

Comprehensive features and interfaces make it possible to flexibly use these compact and powerful PLCs in modular automation solutions. Ethernet ports for connecting to various networks, paired with standard CAN and RS-485 interfaces, expand the functionality of these devices, turning them into universal control and communication points for networked systems.

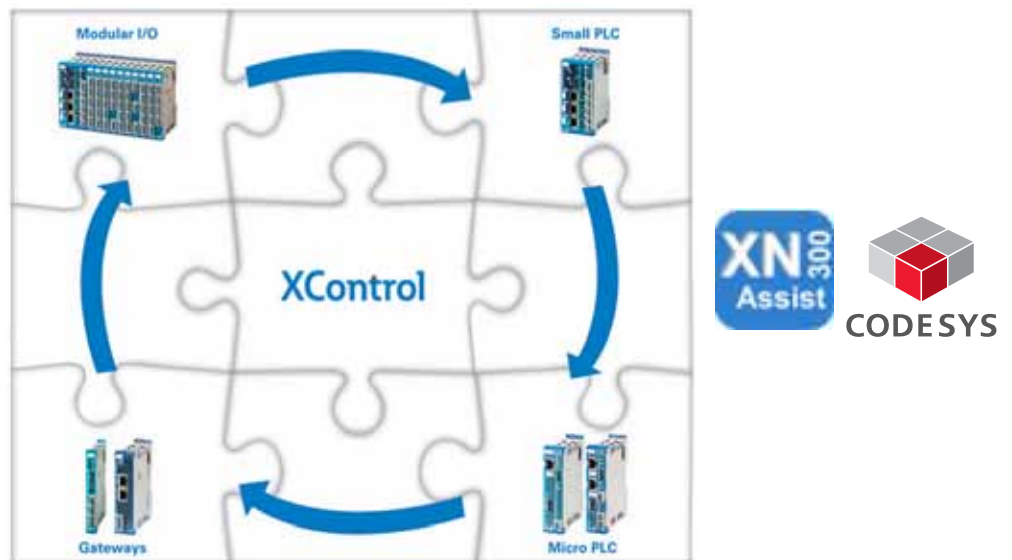

Figure 1: System overview XControl

The PLC consists of the:

- PLC with PSU and local inputs/outputs → Page 14
- I/O system XN300 → Separate "XN300 slice modules" manual.

1 Description of the Modular PLCs XControl: XC-104-..., XC-204-..., XC-303-...

1.2 Communications and interfaces - decentralized expansion



XN300-Assist is a servicing and commissioning tool for the XN300 system – please refer to → Section “3.12 XN300-Assist”, page 72.



In order to program MFD-Titan, you will need XSOFT-CODE-SYS-3 programming software version 3.5.9 or higher.

1.2 Communications and interfaces - decentralized expansion

Modular PLCs XControl: XC-104-..., XC-204-..., XC-303-... support distributed expansion with the use of fieldbus interfaces. The following communication protocols are supported by the corresponding interfaces as follows:

Table 1 Overview Eaton Modular PLCs XControl: XC-104-..., XC-204-..., XC-303-...

Designation	XN300 modules	Retention Data [kb}	ETH 1GB/100MB	RTC	USB	SD-Slot	WEB-Visu HTML5	Interfaces							
								Modbus TCP Server/Client	OPC-UA	Ether-CAT Master/Slave	CAN	CAN-OPEN	RS485	Modbus RTU Server/Client	DIO
XC-303-C32-002	32	128	1x/2x	✓	✓	✓	✓	✓	✓	✓	2x	MS/SL	✓	MS/SL	4x
XC-303-C21-001	32	128	-/2x	✓	✓	✓	✓	✓	✓	✓	1x	MS/SL	✓	MS/SL	–
XC-303-C11-000	32	128	-/1x	✓	✓	✓	✓	✓	✓	✓	1x	MS/SL	–	–	–
XC-204-C20-002	16	32	-/1x	✓	✓	–	✓	✓	✓	✓	–	–	–x	MS/SL	–
XC-204-C21-001	16	32	-/1x	✓	✓	–	✓	✓	✓	✓	1x	MS/SL	✓	–	–
XC-204-C11-003	16	32	-/2x	✓	✓	–	✓	✓	✓	–	1x	MS/SL	–	MS/SL	2x
XC-204-C10-000	16	32	-/2x	✓	✓	–	✓	✓	–	–	–	–	✓	–	2x
XC-104-C10-000	6	4	-/1x	✓	✓	–	✓	✓	–	–	–	–	–x	–	–

1.3 Intended use

Modular PLCs XControl: XC-104-..., XC-204-..., XC-303-... are designed for use in machine and system building applications as compact fanless PLCs with comprehensive features and interfaces that can be used to implement flexible state-of-the-art automation solutions.

The devices are approved for use in automation applications exclusively for controlling machines and systems in closed spaces.

It is strictly prohibited to use the devices in order to implement safety-relevant functions (in the sense of personal and machine protection).

Observe the labels on the modular PLC housing and the corresponding approval specifications and technical data.

Any other use must be discussed and agreed upon with the manufacturer in advance.

1 Description of the Modular PLCs XControl: XC-104-..., XC-204-..., XC-303-...

1.3 Intended use

→ Section “20.2 Approvals and national approvals”, page 171

→ Section “20.3 Technical specifications”, page 172

Modular PLCs XControl: XC-104-..., XC-204-..., XC-303-... may only be operated if they have been installed and connected by a qualified electrician. The installation must comply with regulations for electromagnetic compatibility (EMC).



DANGER POSED BY AUTOMATIC STARTING

Powering up the XControl must not result in any hazards being posed by controlled devices, e.g., motors starting unforeseeably or voltages being unexpectedly applied.

1 Description of the Modular PLCs XControl: XC-104-..., XC-204-..., XC-303-...

1.4 Versions

1.4 Versions

The following XControl device models are available:

- XC-104-C10-000
- XC-204-C10-000
- XC-204-C11-003
- XC-204-C21-001
- XC-204-C20-002
- XC-303-C11-000
- XC-303-C21-001
- XC-303-C32-002

1.4.1 XC-104-... and XC-204-...

XControl	XC-104-C10-...	XC-204-C10-...	XC-204-C11-...	XC-204-C20-...
⑪ S1				
STOP	√	√	√	√
SF	√	√	√	√
TC	-	-	√	√
TRSa	-	-	√	√
TRSB	-	-	√	√
① ② ETH0	√	√	√	√
③ USB Host, Typ A	√	√	√	√
④ X4	√	√	√	√
V+ 24 V DC	√	√	√	√
0V GND	√	√	√	√
⑤ ⑥ ETH1	-	-	-	√
⑥ X1	-	-	√	√
RS485 RS485 a	-	-	√	√
RS485 b	-	-	√	√
GND RS	-	-	√	√
⑦ X2	-	-	√	-
CAN1 CAN_H	-	-	√	-
CAN_L	-	-	√	-
GND CAN	-	-	√	-
④ ⑧ X3	-	-	-	√
I/Q1	-	-	-	√
I/Q2	-	-	-	√

Figure 2: XC-104-... and XC-204-... connectors

1.4.2 XC-303-...

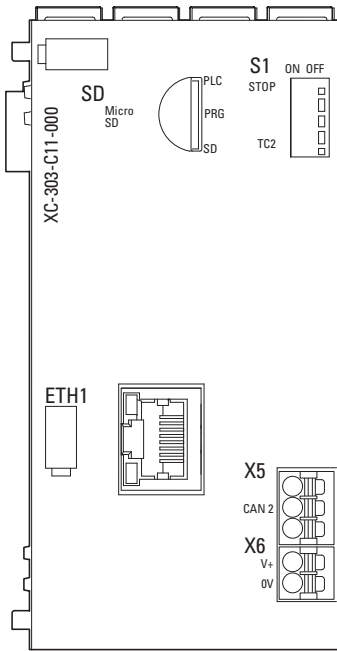

Figure 3: XC-303-C11-000

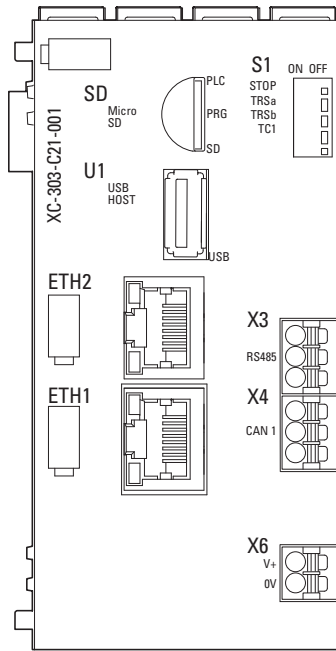

Figure 4: XC-303-C21-001

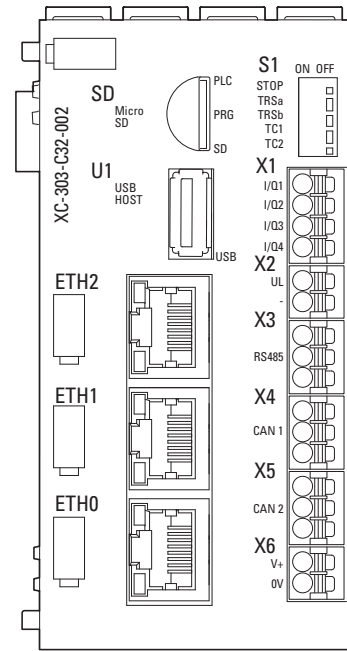

Figure 5: XC-303-C32-002

1 Description of the Modular PLCs XControl: XC-104-..., XC-204-..., XC-303-...

1.4 Versions

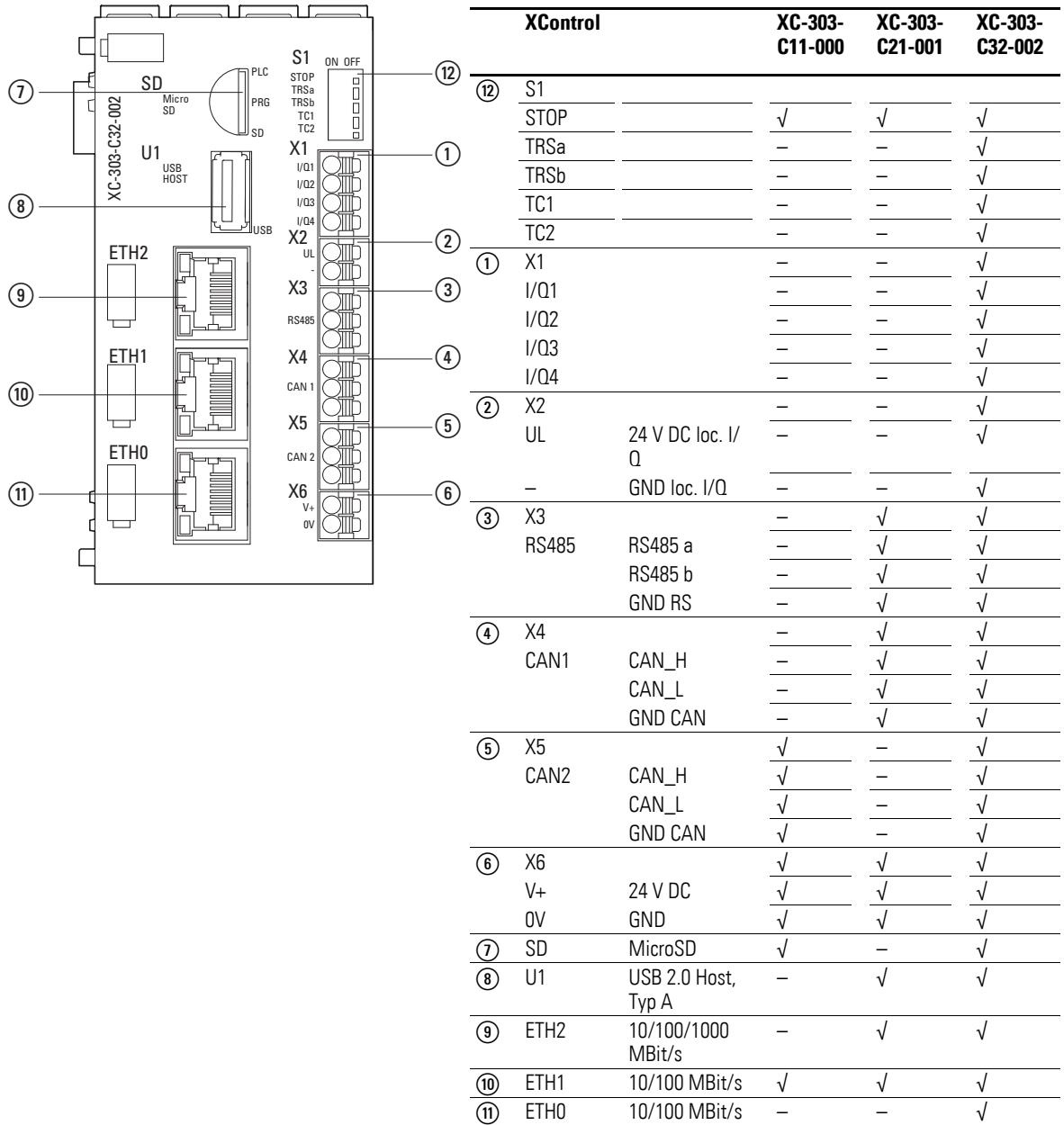
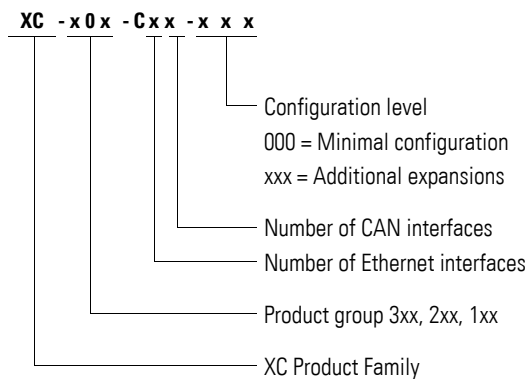

Figure 6: Structure XC-303-...

1 Description of the Modular PLCs XControl: XC-104-..., XC-204-..., XC-303-...

1.5 Key to XControl part numbers

1.5 Key to XControl part numbers



1.5.1 Device Version Number

The device version number is shown on the back of the housing of each Modular PLCs XControl: XC-104-..., XC-204-..., XC-303-... device. These are the first two digits of the device number.

The device version number provides useful service information about the hardware version and operating system version.

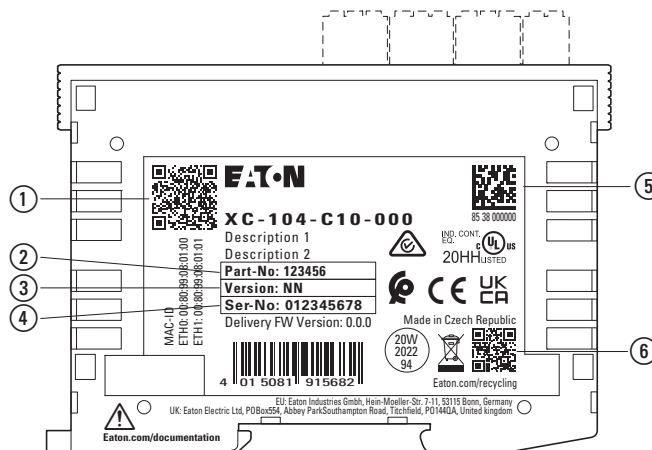

Figure 7: Device side with printed device version number

- ① MAC address QR code
- ② Article number
- ③ Device address
- ④ Serial number
- ⑤ Serial number 2D QR code
- ⑥ Eaton product page QR code

1 Description of the Modular PLCs XControl: XC-104-..., XC-204-..., XC-303-...

1.6 Functionality

1.6 Functionality

1.6.1 Power Supply

There is a power connector for powering the processor unit.

Terminal X6 (label: V+/0V) features a 24-V connector for the processor unit and all the slice modules connected to the system bus.

If there is a voltage dip of the 24 V supply voltage (switching threshold is about 10 V) then a power-down logic switches of the 5 V supply to the signal modules (central I/O).

1.6.2 Local inputs/outputs

The digital inputs/outputs can be used either as an input or as an output and connected to sensors or actuators.

They can be used for an interrupt circuit in the application.

When used as outputs, they are designed for 24-V signals.

The following applies to XC-303-...: The digital inputs/outputs feature an additional separate, shared power supply at X2 (label: UL/-) that is galvanically isolated from the bus.

The following applies to XC-204-: The digital inputs/outputs use the shared power supply at X4 (label: V+/0V), which is not galvanically isolated from the bus.

The outputs can be loaded with 500 mA, a duty factor (ED) of 100% and a utilization factor (g) of 100%.

The outputs are short-circuit proof.

XControl	Digital inputs/outputs	Current	Simultaneity factor g
XC-104-C10-000	–	–	–
XC-204-C10-000	2	500 mA	100 %
XC-204-C11-003	2	500 mA	100 %
XC-204-C21-001	–	–	–
XC-204-C20-002	–	–	–
XC-303-C11-000	–	–	–
XC-303-C21-001	–	–	–
XC-303-C32-002	4	500 mA	100 %

1.6.3 Processor unit

Belonging to the processor unit are:

- Processor ARM CORTEX A7 (XC-303-...: Dual Core),
- Memory → Page 19,
- CPU drives → Page 19,
- Real Time Clock (RTC) → Page 19,
- Device interfaces → Page 21,

Real Time Clock (RTC)

All XControl modular PLCs feature a real-time clock that you can access in the user program. Possible functions are:

- Display mode for hours (12/24 hour display),
- Reading and setting of the real-time clock.

A description of the functions can be found in the XSOFT-CODESYS-3 manufacturer documentation for the SysLibRTC.lib library.

In addition, you can set and read the real-time clock with the following PLC shell commands respectively:

- `setrtc` (set the real-time clock),
- `getrtc` (query the real-time clock).

Even in the event of a power supply failure, the real-time clock will continue to work for up to 10 days thanks to a memory backup capacitor.

XControl	Real-time clock tolerances
XC-104-...	–
XC-204-...	± 3 s / day at 25° C
XC-303-...	± 3 s / day at 25° C

Memory

Modular PLCs XControl: XC-104-..., XC-204-..., XC-303-... feature 128 MB of program memory (flash), 512 MB of RAM, and 128 kB of memory for saving non-volatile application data (NVRAM).

XControl	Program memory (FLASH)	Cache memory	Retentive data
XC-104-...	2 GB	256 MB	–
XC-204-...	2 GB	256 MB	32 kB [MRAM/FRAM]
XC-303-...	128M Bytes	512 MB	128 kB [NV-RAM]

CPU drives

The XC300 has the following drives available:

1 Description of the Modular PLCs XControl: XC-104-..., XC-204-..., XC-303-...

1.6 Functionality

Drives	XC300	XC200	XC100
Inside			
System memory	"\home"	"/home"	"/home"
external (optional)			
MicroSD memory card	"\home\disk_sd" „/home/codesys/work“ ¹⁾	"/home/disk_sd" „/home/codesys/work"	"/home/disk_sd" „/home/codesys/work"
USB device	"\home\disk_usb" „/home/codesys/work“ ¹⁾	"/home/disk_usb" „/home/codesys/work"	"/home/disk_usb" „/home/codesys/work"

1) On XC300 with XSOFT-CODESYS-3 Version 3.5.17 or higher

- Inside
 - "\home" system memory
- external (optional)
 - MicroSD memory card "\home\disk_sd"
 - USB device "\home\disk_usb".

The boot application and the operating system are stored in compressed format and protected against power supply failures in the transactionally safe system memory.

In the operating state, the boot application and the relevant sections of operating system are "unpacked" and copied into the working memory. Meanwhile, the retentive data is stored in the non-volatile NVRAM memory.

On all XControl modular PLCs, only the real-time clock (RTC) is backed up with a capacitor. This backup makes it possible for the clock to keep working for 10 days when the device is de-energized.



Transaction safe means that if there is a voltage dip when the file is being processed, the file system and the opened file are generally not destroyed. It is possible however, that data which you have written into the file last opened may be lost.

Figure 8 indicates the interaction of the differing XC300 memory systems/drives.

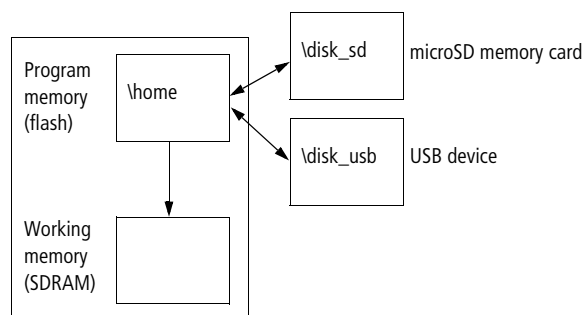

Figure 8: XC300 memory organization

1.6.4 Device interfaces



CAUTION INTERFERENCES

The values specified in the technical data, as well as the device's electromagnetic compatibility (EMC), cannot be guaranteed if the following are used: unsuitable cables, improperly assembled and terminated cables, and/or wiring that does not conform to the applicable standards. Only use cables assembled and terminated by professionals.

The cables being used must be assembled and terminated as required by the port/interface description in this document. When wiring the devices, follow all instructions regarding how to wire the corresponding port/interface. All general Directives and standards must be complied with.



CAUTION NON-GALVANICALLY-ISOLATED INTERFACES

The device may be damaged by potential differences.

- ▶ The GND terminals of all bus modules must be connected.
- ▶ Do not connect the connector to the device or disconnect it without first de-energizing the system.



High loads on CPU resources can result in functional limitations. If device access through the programming system is limited due to the load on the device, interrupt the program sequence by switching the RUN/STOP switch to STOP.

1.6.4.1 USB host 2.0



The USB interface for XC-104-..., XC-204-... devices needs to be activated before the first time it is used – please refer to → Section “3.2 USB interface activation for XC-104-... and XC-204-... devices”, page 53.



Please note that the maximum current load for the USB interface on the XC-303-... is 100 mA and that the maximum current load for the USB interfaces on the XC-104-... and XC-204-... is 500 mA.

Only one USB storage device can be used at a time. This applies even if using a USB hub would make it possible to use multiple USB storage devices, for example.

The output voltage is protected from overloads.

1 Description of the Modular PLCs XControl: XC-104-..., XC-204-..., XC-303-...

1.6 Functionality

Table 2 USB 2.0 Host, type A, downstream port, USB port pinout

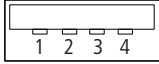
USB-Host Type A	PIIN	signal
	1	+5 V $\overline{---$
	2	USB-
	3	USB+
	4	GND

See also:

- Technical data → Page 172

USB cable

- Use standard shielded USB 2.0 cables only.
- Maximum cable length: 5 m.

See also:

- Technical data → Page 172

1.6.4.2 MicroSD memory card, USB device

MicroSD memory card and USB device are used to run external mass storage devices. You can load the recipe data, general data and the user program onto them. The operating system (OS) supports memory types with the FAT32 file system.

You can transfer the operating system to the MicroSD or the USB device in order to load it onto other PLCs from there by updating the operating system → Section “3.3 Startup behavior XC-104-..., XC-204-..., XControl”, page 56.

XControl	SD card	USB
XC-104-...	–	✓
XC-204-...	–	✓
XC-303-...	32 GB	✓

ATTENTION

The file system of the MicroSD memory card and USB device is not transaction-safe.

Accordingly, make sure that the program has closed all files before you remove a MicroSD and/or USB device or turn off the power.

MicroSD memory card

The SD LED shows a green light to indicate that a MicroSD is inserted.



We recommend using a MicroSD memory card that is suitable for industrial data storage, such as item 191087, MicroSD memory card 2 GB with adapter.

USB device

The USB port can also be used to load the user program or update the system.



CAUTION

When using commercially available peripheral devices with the USB Host, it is important to keep in mind that their EMC interference immunity parameters may render them unsuitable for use in industrial environments.



**CAUTION
NON-GALVANICALLY-ISOLATED INTERFACES**

The device may be damaged by potential differences.
 ► Do not connect the connector to the device or disconnect it without first de-energizing the system.

1.6.4.3 Ethernet

Every Ethernet port (ETH0, ETH1, or ETH2) can be used for communication between the Modular PLCs XControl: XC-104-..., XC-204-..., XC-303-... and the programming device.

Each of the device's Ethernet ports provides a different transfer rate:

Interface	Baud Rate [MBit/s]	XC-303-C32-002	XC-303-C21-001	XC-303-C11-000	XC-204-C20-002	XC-204-C21-001	XC-204-C11-003	XC-204-C10-000	XC-104-C10-000
ETH0	10, 100	√	–	–	√	√	√	√	√
ETH1	10, 100	√	√	√	√	√	–	–	–
ETH2	10, 100, 1,000	√	√	–	–	–	–	–	–

These Ethernet ports are used for programming and debugging, as well as to update the PLC's operating system.

Recommendation: Use an Ethernet connection when connecting a PC

Please note:

- Every Ethernet interface must have a correct network configuration.
- If a device has multiple Ethernet interfaces, they must use different network addresses, i.e., one of the first three octets must be used to differentiate between them.

1 Description of the Modular PLCs XControl: XC-104-..., XC-204-..., XC-303-...

1.6 Functionality

Table 3 Assignment of the Ethernet interface

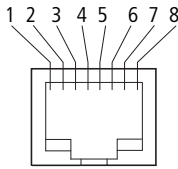
RJ45 socket	PIN	Ethernet 10/100 MBit	Ethernet 1000 MBit
	8	–	BI–_D4
	7	–	BI+_D4
	6	Rx–	Rx–_D2
	5	–	BI–_D3
	4	–	BI+_D3
	3	Rx+	Rx+_D2
	2	Tx–	Tx–_D1
	1	Tx+	Tx+_D1

Ethernet (patch) cable

The connecting cable to be selected depends on the the ambient conditions at the installation location (interference, flexibility, transmission speed).

- Use standard Ethernet (patch) cables with RJ45 connectors of category Cat 5 or higher only. (IEC/EN61131-2, EN50178)
- Maximum cable length: 100 m.
If the network covers a longer distance, use the required appropriate infrastructure components.
- Observe the installation guidelines for (Ethernet) wiring in ISO/IEC 11801 and EN 50173.



CAUTION FORCES ON THE ETHERNET INTERFACE

Communications may be affected, and the connection's mechanical components may be damaged, if the Ethernet interface is subjected to strong vibrations or the RJ45 plug-in connection is subjected to pulling.

- Protect the RJ45 plug-in connection from strong vibrations.
- Protect the RJ45 plug-in connection from tensile forces at the socket.

To establish communications between Modular PLCs XControl: XC-104-..., XC-204-..., XC-303-... and the programming device, follow the description for your connected device.

Default IP addresses

The Ethernet interfaces are delivered with the following IP addresses by default:

Interface	XC-303-...	XC-204-...	XC-104-...
ETH0	192.168.119.248	192.168.119.204	192.168.119.104
ETH1	192.168.137.248	DHCP	–
ETH2	192.168.138.248	–	–

Subnet mask: 255.255.255.0

See also:

- Functionality → Page 18
- Technical data → Page 172

1.6.4.4 RS485

The serial RS-485 interface (X3) depends on the device model.

XControl	RS485 serial interface for Modbus RTU
XC-303-...	✓ ¹⁾
XC-204-C20-002	✓
XC-204-C21-001	–
XC-204-C11-003	✓
XC-204-C10-000	–
XC-104-...	–

1) Galvanically isolated from the system power supply

The serial RS-485 interface (X3) can be used to connect an external display device, for example.

The RS-485 connection can be used to connect to another PLC as a Modbus RTU master or Modbus RTU device. The protocol supports EVEN, ODD, and NONE parity, as well as 1 or 2 stop bits, and is accordingly in conformity with the CODESYS serial adapter.

Screened twisted-pair cables must be used.

Adjustable baud rates [bauds]	Maximum possible cable length
1200	1200 m
2400	
4800	
9600	
19200	
38400	
576000	
115200	

Configuration: X3 plug connector, 3-pin, spring-loaded plug-in terminal block

1 Description of the Modular PLCs XControl: XC-104-..., XC-204-..., XC-303-...

1.6 Functionality

Table 4 PLUG-FMC-3S spring-loaded plug-in terminal block with RS-485 interface pinout

Plug connector	X1 (XC-104-..., XC-204-...) X3 (XC-303-...)	RS485
	1	Data cable A
	2	Data cable B
	3	GND RS485

Activating the bus termination resistors

The first and last stations on the RS-485 cable must be terminated with a bus termination resistor.

To activate the bus termination resistors for the RS-485 cable, switch the following two DIP switches on S1 to the ON position:

- XC-303-...: TRSa and TRSb
- XC-104-..., XC-204-...: 3 and 4

XC-303-... XC-104-... and XC-204-...
TRSa and TRSb 3 and 4

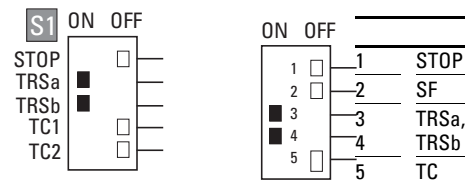

Figure 9: DIP switch S1 on XC-303-... and XC-104-.../XC-204-...

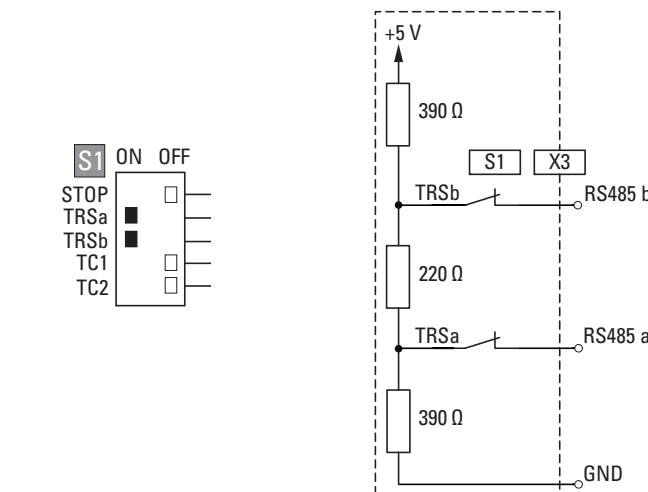

Figure 10: Activating the bus termination resistors for the RS-485 interface

RS485 cable

- Use the specified connection cable assembled by electrically qualified personnel only.

- Maximum cable length: 1200 m.

See also:

- Functionality → Page 18
- Technical data → Page 172

1.6.4.5 CAN

The CAN interfaces depend on the device model.

XControl	CAN1	CAN2
XC-303-C32-002	✓ ¹⁾	✓
XC-303-C21-001	✓ ¹⁾	–
XC-303-C11-000	–	✓
XC-204-C20-002	–	–
XC-204-C21-001	✓	–
XC-204-C11-003	✓	–
XC-204-C10-000	–	–
XC-104-C10-000	–	–

1) electrically isolated

The CAN interfaces can be run individually as a CAN master or CAN device.

The CAN 1 interface (X4) on XC-303-...- devices is galvanically isolated from power supply U_s (X6). This is not the case for any other devices or CAN interfaces.

The CANopen protocol can be run simultaneously by the MFD-Titan.

Configuration: X4 and/or X5 plug connector, 3-pin, PLUG-FMC-3S spring-loaded plug-in terminal block.

Table 5 Configuration of the CAN interface

Plug connector	X4, X5	CAN
	1	CAN_H
	2	CAN_L
	3	GND CAN

Activating the bus termination resistors

Bus termination resistors must be installed at the first and last station on the CAN bus. A bus termination resistor with a resistance of 120 Ω can be activated with DIP switches for this purpose.

To activate the bus termination resistors for CAN 1, switch the following DIP switch on S1 to the ON position:

- XC-303-...: TC1

1 Description of the Modular PLCs XControl: XC-104-..., XC-204-..., XC-303-...

1.6 Functionality

- XC-204-...: 5

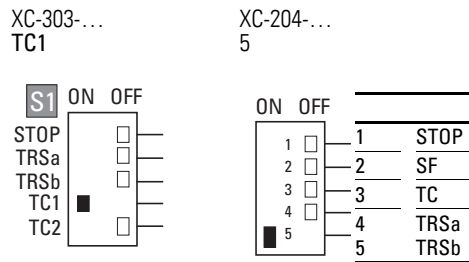

Figure 11: S1 DIP switch setting for CAN1

To activate the bus termination resistors for CAN 2 on XC-303-..., switch the S1 TC2 DIP switch to the ON position:

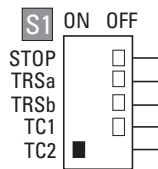

Figure 12: S1 DIP switch setting for CAN2

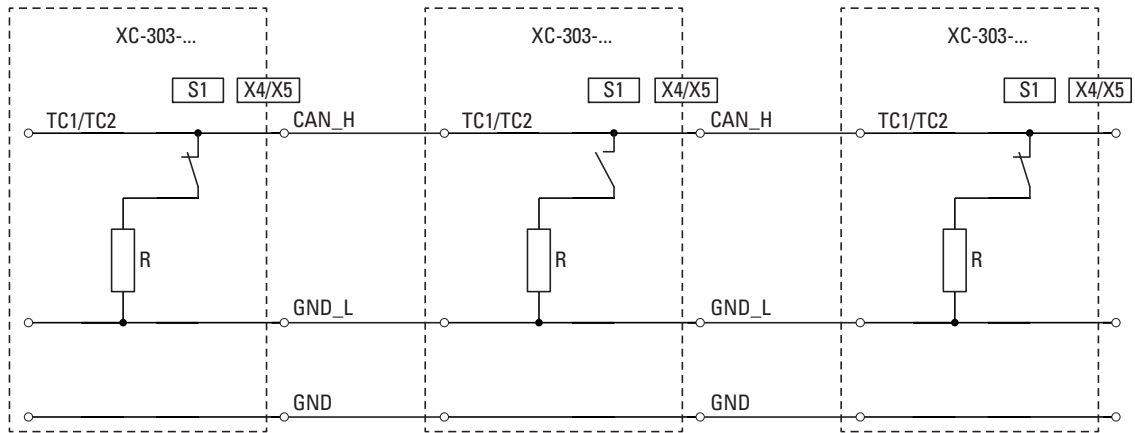

Figure 13: Activating the bus termination resistors for the CAN interfaces (CAN1 or CAN2)

CAN baud rates and cable lengths

- Use connection cables that conform to ISO 11898 only.
- The maximum cable length is determined by the baud rate.

Table 6 Max. cable lengths CAN

CAN baud rates [kbauds]	Maximum possible cable length
50	1000 m ^{2,3} ² Starting from a cable length of 200 m, we recommend using optocouplers in the CAN stations
100	600 m ²
125	500 m ²

CAN baud rates [kbauds]	Maximum possible cable length
250	250 m ² ³ It may be necessary to use repeaters starting from a cable length of 1000 m
500	100 m
800	50 m
1,000	25 m



If an application attempts to activate an unsupported baud rate, the CAN controller will switch to passive mode.

Reaction of the station on the CAN bus

Station/bus monitoring: CAN telegrams are sent and received directly by the user program. An interruption on the CAN Bus will only be recognized when the respective CAN slave is monitored by the PLC (Nodeguarding function).

Start/Stop behavior:

Can be configured with the application.

- Reset to default value (usually "0")
- The current value is maintained (user-specific)

Switch on voltage:

The order in which you switch on the power supply of the individual CAN stations has no effect on the functioning of the CAN bus. Depending on the parameters set, the controller "waits" for stations that are not present or starts them when the station is connected to the CAN net.

Communication with CAN stations:

The following documents describe the communication with the CAN stations and their configuration:

- XSOFTE-CODESYS-3 manufacturer documentation, online help
Library description: CANUser.lib/CANUser_Master.lib
- Field bus support -> CAN-based field buses
- CANopen -> CANopen Manager (Master)
- Documentation for the CAN modules used

An LED green blinking next to the X4 or X5 plug connector (whichever is in use) will indicate when data is being transferred on the CAN bus. → Section "3.6 LED indicators", page 63.

See also:

- Functionality → Page 18
- Device Interface → Page 21
- Technical data → Page 172

1 Description of the Modular PLCs XControl: XC-104-..., XC-204-..., XC-303-...

1.6 Functionality

2 Installation



CAUTION

Installation requires qualified electrician



DANGER OF ELECTRIC SHOCK!

All (de-)installation work must be carried out with the entire installation in a de-energized state.

Follow the safety rules in DIN VDE 0105:

- De-energize and isolate the system.
- Secure against retriggering.
- Verify complete isolation from the supply.
- Earthing and short-circuiting.
- Cover or enclose any neighboring live parts.

2.1 Control panel layout

The layout of the components inside the control panel is a major factor for achieving interference-free functioning of the plant or machinery. During the project planning and design phase, as well as its implementation, care must be taken that the power and control sections are separated.

The power section includes:

- Contactors
- Coupling/interfaces components,
- Transformers,
- Variable frequency drives,
- Current converters.

In order to effectively exclude any electromagnetic interference, it is a good idea to divide the system into sections, according to their power and interference levels. In small control panels it is often enough to provide a sheet steel dividing wall, to reduce interference factors.

2.1.1 ventilation

When designing the system, make sure that the Modular PLCs XControl: XC-104-..., XC-204-..., XC-303-... are adequately ventilated.

In order to ensure that the maximum operating ambient temperature will not be exceeded, make sure that there is enough clearance between the system block's vents and any neighboring components, as well as between the vents and the control panel's back plate.

Keep a minimum clearance of 50 mm from passive components. If the adjacent components are active elements (e.g., power supplies, transformers), keep a minimum clearance of 75 mm instead.

2 Installation

2.2 Mounting XControl

2.2 Mounting XControl

XC-303-... must be installed exclusively horizontally on an EN/IEC 60715 DIN-rail (TS 35). XC-104-... and XC-204-... modular PLCs can also be installed horizontally with the DIN-rail, but only in such a way that the modular PLC will be underneath any additional XN300 slice modules – please refer to → Figure 15, page 33, B.

Make sure to keep the minimum clearances required for ventilation.

Before installation, expand the Modular PLCs XControl: XC-104-..., XC-204-..., XC-303-... with the required XN300 slice modules to get the system block you want.

Observe the following when installing the device in a control cabinet, distribution board, or enclosure:

- The power supply connections and the terminal connections must be protected from being touched directly during operation.
- The DIN-rail must establish a conductive connection to the control panel's back plate.
- The whole system block needs to be mounted on the DIN-rail and then secured in place by closing the locking elements.



Detailed instructions on how to install the XN300 slice modules can be found in the "XN300 slice modules" manual.

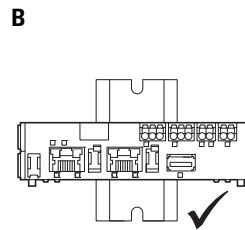
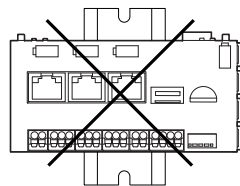
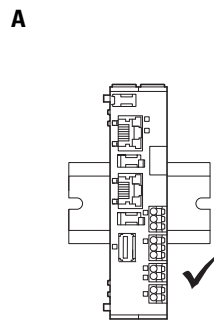
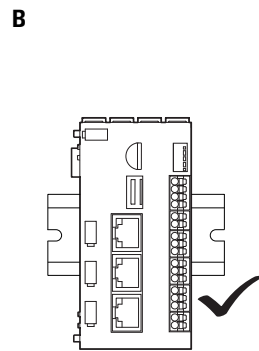

Figure 14: XC-303-...

Figure 15: XC-104-..., XC-204-...

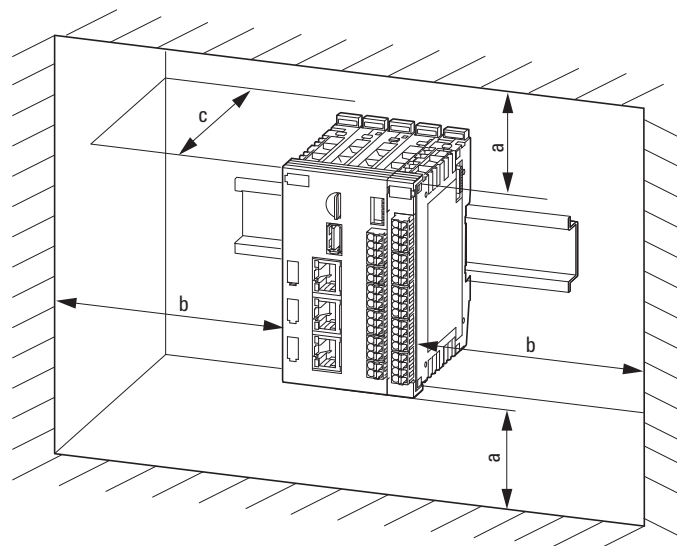

Figure 16: Installation using the XControl for a system block as an example

a	b	c	θ
30 mm (1.18")	30 mm (1.18")	100 mm (3.94")	$\leq 60^{\circ}\text{C}$ ($\leq 140^{\circ}\text{F}$), A $\leq 55^{\circ}\text{C}$ ($\leq 131^{\circ}\text{F}$), B

The following figures use an XC-303-... device as an example to show and illustrate the installation requirements. To do this, follow the steps below:

- The Modular PLCs XControl: XC-104-..., XC-204-..., XC-303-... must be the first element on the left in the system block.

2 Installation

2.2 Mounting XControl

- ▶ Disengage the side locking tabs on the XN300 slice modules by pulling on the front cover (blue). Make sure that all locking tabs (blue) are in the front so that they will engage the new slice. (the front cover stay-put function is intended to make the process easier).



The front cover of the Modular PLCs XControl: XC-104-..., XC-204-..., XC-303-... is non-detachable and cannot be removed.

- ▶ Attach an XN300 slice module from the right in such a way that the locking tabs engage the guide.

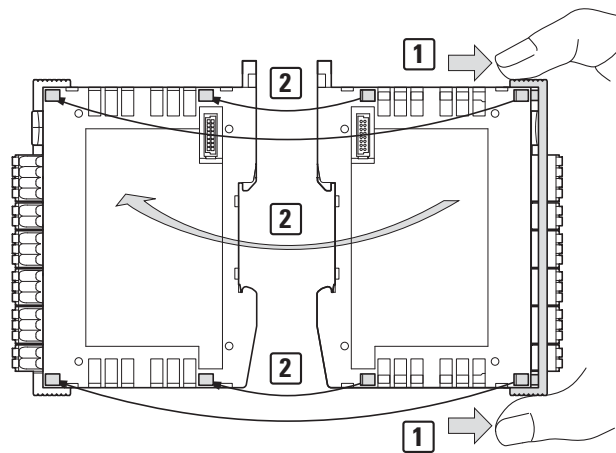

Figure 17: Joining the XControl modules and XN300 to form a system block

- ▶ Grab the front cover from the top and bottom and push it back towards the XN300 slice module so that the modules lock solidly into place with each other.

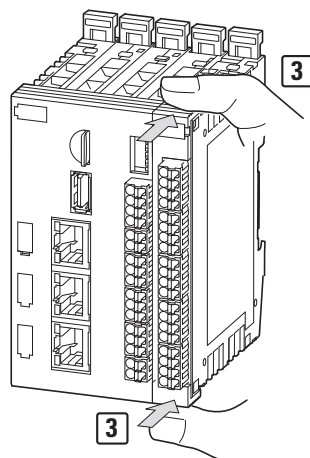

Figure 18: Locking the system block in place

- ▶ Repeat these steps until all the XN300 slice modules form a system block together with the PLC.

- ▶ Pull the locking elements at the back of the Modular PLCs XControl: XC-104-..., XC-204-..., XC-303-... and all XN300 slice modules up. You can use a screwdriver to do this.

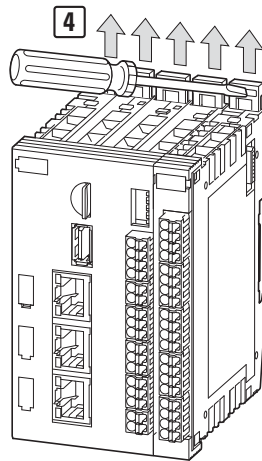

Figure 19: Securing the system block on the DIN-rail

- ▶ Tilt the system block forward and place it against the DIN-rail's bottom edge in an inclined position.

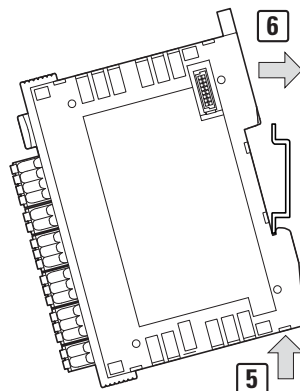

Figure 20: Placing the system block against the bottom edge of the DIN-rail

- ▶ Push the system block over the DIN-rail's top edge.
- ▶ Secure the system block.
To do this, push the locking elements at the back of the Modular PLCs XControl: XC-104-..., XC-204-..., XC-303-... and all XN300 slice modules down. You can use a screwdriver to do this.

2 Installation

2.3 Uninstalling and disassembly (using the XControl as an example)

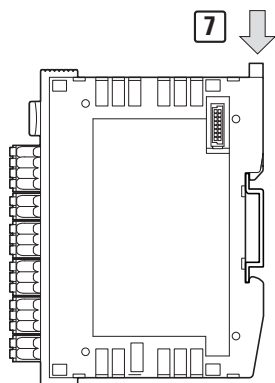

Figure 21: Locking the system block into place on the DIN-rail

- ▶ Check to make sure that the system block is solidly mounted.

2.3 Uninstalling and disassembly (using the XControl as an example)

- ▶ De-energize the system.
Follow the safety rules in DIN VDE 0105 when doing so:
- ▶ Press on the release mechanism (with a screwdriver, for example) to release all contacts.
- ▶ Disconnect all plug connectors from the Modular PLCs XControl: XC-104-..., XC-204-..., XC-303-... and the XN300 slice modules.

To disassemble the system block, follow the steps below:

- ▶ Slide the locking elements at the back of the XControl and the XN300 slice modules up.
You can use a screwdriver to do this.

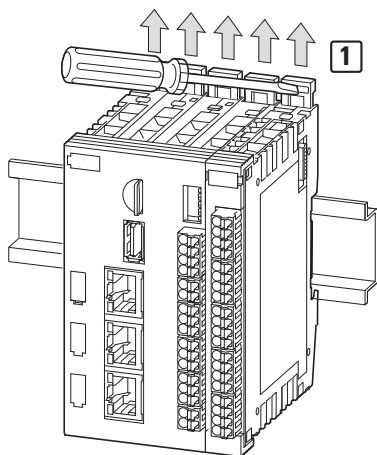

Figure 22: Releasing the system block locking elements

- ▶ Tilt the system block forward, then pull the block, from its bottom edge, away from the DIN-rail.

2.3 Uninstalling and disassembly (using the XControl as an example)

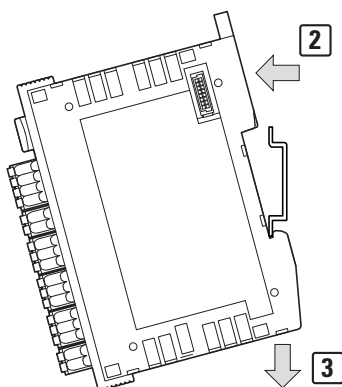

Figure 23: Placing the system block against the bottom edge of the DIN-rail

- ▶ Disengage the locking tabs between the modules by pulling on the front cover (blue).



The front cover's stay-put function will indicate that the locking tabs have been disengaged.

The front cover of the Modular PLCs XControl: XC-104-..., XC-204-..., XC-303-... is non-detachable and cannot be removed.

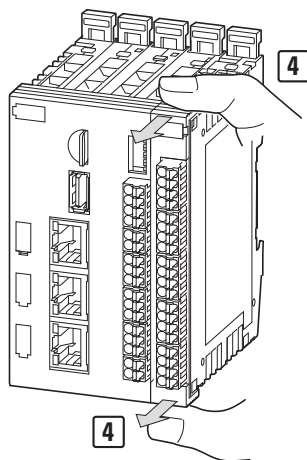

Figure 24: Disengaging the front cover

- ▶ Once the locking tabs have been disengaged, you can separate the modules from each other.

2 Installation

2.4 Connection terminals

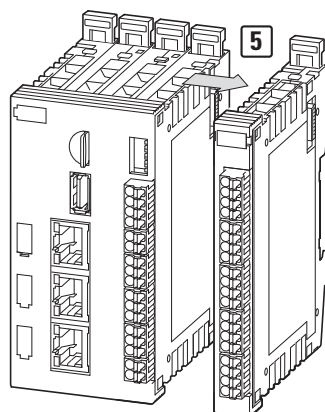

Figure 25: Disassembling the system block

2.4 Connection terminals

Plug connector

X1 – Xn: The plug connectors with spring-loaded push-in terminals are included as standard with the Modular PLCs XControl: XC-104-..., XC-204-..., XC-303-....

Connecting cable



Only use copper cables designed for at least 90°C as the connecting cable.

To use them, the conductor simply needs to be slid into the appropriate contact and will be locked into place.

In order to release the conductor, simply press on the release mechanism, e.g., with a screwdriver, to pull out the conductor from the corresponding contact.

Table 7 Connection specifications

Cable cross-sectional areas			XControl
 10 mm (0.39")	solid	mm ²	0.2 – 1.5
 10 mm (0.39")	Flexible with uninsulated ferrule	mm ²	0.2 – 1.5
 10 mm (0.39")	Flexible with insulated ferrule	mm ²	0.2 – 0.75
 Ferrule d		mm	≤ 2.8
	AWG		24 – 16
	Strip length	mm	10

2.5 Potential relationship between the components

Modular PLCs XControl: XC-104-..., XC-204-..., XC-303-... feature a contact point that is used to establish a protective earth connection to the DIN-rail. Moreover, all power supply earth connections are connected to the protective earth.

One exception is the XC-303-... supply voltage for the local inputs and outputs U_L at terminal X6. The ground connection at X6 is not connected to the protective earth.

- 0V
- \oplus

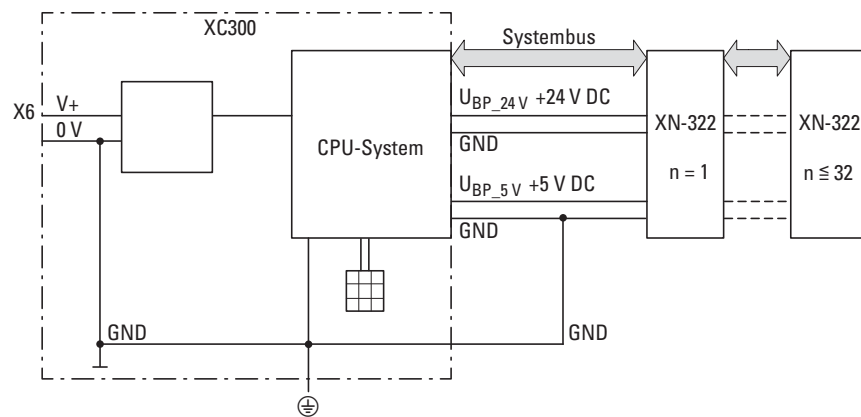

Figure 26: Potential relationships Modular PLCs XControl: XC-104-..., XC-204-..., XC-303-... with I/O system XN300

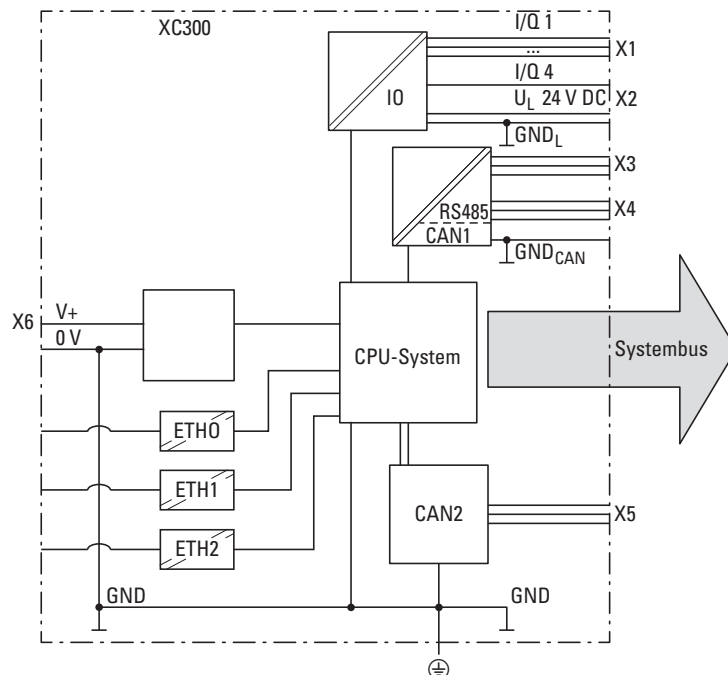

Figure 27: Potential relationships XControl

2 Installation

2.6 Wiring in accordance with EMC requirements

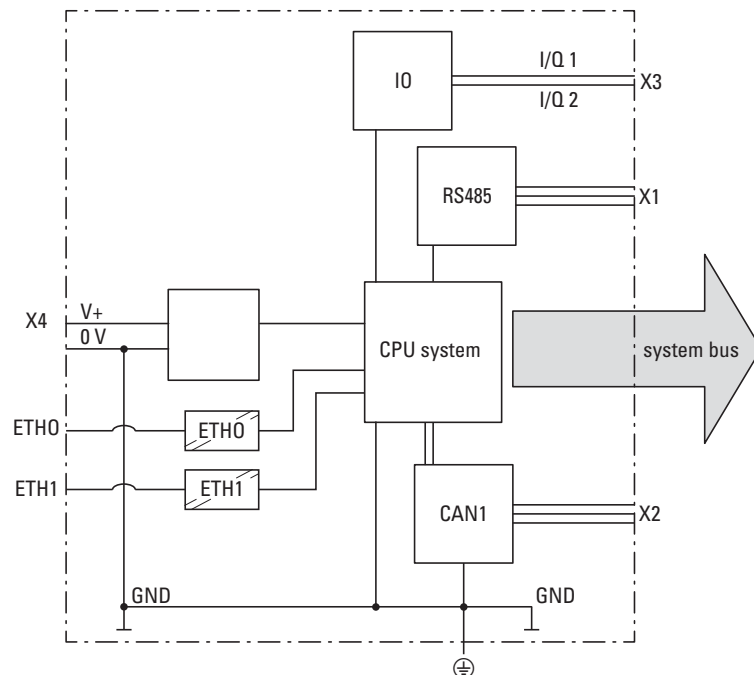

Figure 28: Potential relationships XC-104-..., XC-204-...

The galvanic isolation for the Ethernet interfaces is listed in the appendix – please refer to → Section “ Galvanic separation”, page 173.

2.6 Wiring in accordance with EMC requirements

Undesired faults can occur on the field bus and the analog inputs due to electromagnetic interference. This can be minimized beforehand by the implementation of suitable EMC measures.

These include:

- EMC-conformant system configuration,
- Routing all analog input and field bus cables in a way that meets EMC requirements
- Measures designed to reduce potential differences
- the correct installation of the field bus system (cable, connection of the bus connectors, etc.),
- Using shielding

for DIN-rail

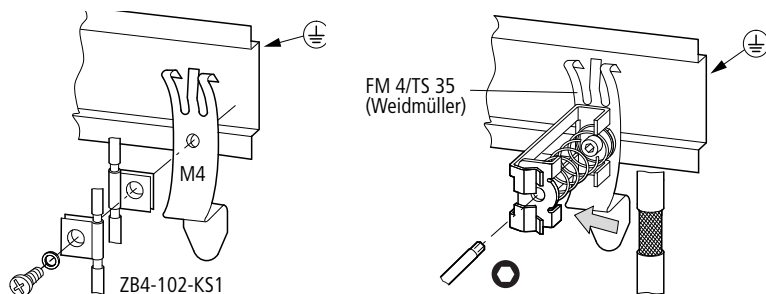

Figure 29: Field bus shielded by using a shield

Modular PLCs XControl: XC-104-..., XC-204-..., XC-303-... feature a protective earth connection point at the back.

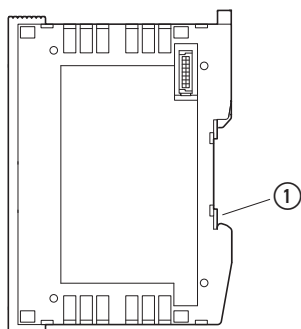

Figure 30: Page preview XControl

① Functional earth

2 Installation

2.7 Lighting protection

2.6.1 Cable routing and wiring

Cables are divided into the following categories:

- Electric power lines (e.g. power cables carrying high currents, or lines to current converters, contactors, solenoid valves),
- Control and signal cables (e.g. digital input cables),
- Measurement and signal cables (e.g. fieldbus cables).



Always route power cables and signal cables as far apart as possible. This avoids capacitive and inductive coupling. If separate cable routing is not possible, then the first priority must be to shield the cable responsible for the interference.

Take care to implement proper cable routing both inside and outside the control panel, to keep interference as low as possible:

- ▶ Avoid parallel routing of sections of cable in different power categories.
- ▶ As a basis rule, keep AC cable separated from DC cables.
- ▶ Keep to the following minimum clearance:
 - at least 10 cm between power cables and signal cables;
 - at least 30 cm between power cables and data or analog cables.
- ▶ When routing cables, make sure that the outgoing and return leads of a circuit pair are routed together. The opposing currents on this cable pair cause the sum of all currents to equal zero. The generated electromagnetic fields cancel each other out.

2.6.2 Suppressor circuit for interference sources

- ▶ Connect all suppressor circuits as close to the source of interference (contactors, relays, solenoids) as possible.



Switched reactors should always have suppressor circuitry fitted.

2.6.3 Screen earth kit

- ▶ Use shielded cables for the connections to the data interfaces.

The general rule is:

the lower the coupling impedance, the better the shielding effect.

2.7 Lighting protection

2.7.1 External lightning protection

All cables between buildings must be shielded. Metal conduits are recommended for use here. Fit signal cables with overvoltage protection, such as varistors or other surge arresters. Implement these measures ideally where the cable enters the building and at least at the control panel.

2.7.2 Internal lightning protection

Internal lightning protection covers all those measures taken to reduce the effects of a lightning strike and the resulting electrical and magnetic fields on metallic installation and electrical plant. These measures are:

- Lightning protection equipotential bonding
- Shielding,
- Using surge protective devices

2 Installation

2.8 Connecting the power supply

2.8 Connecting the power supply



DANGER

The power supply for the Modular PLCs XControl: XC-104-..., XC-204-..., XC-303-... must be a SELV power supply unit.

The power supply is protected against polarity reversal.

2.8.1 XC-303-... power supply

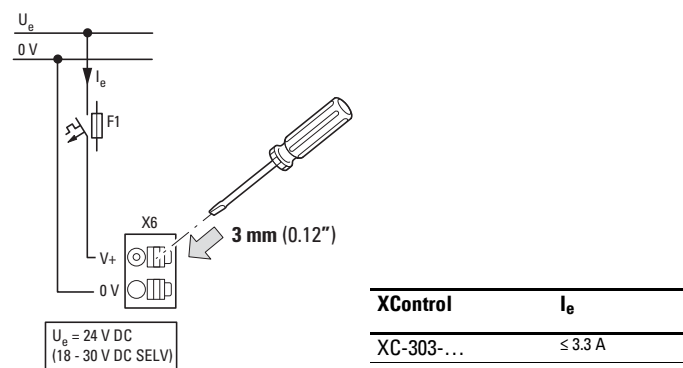

Figure 31: Connecting the XC-303-... power supply

2.8.2 XC-104-..., XC-204-... power supply

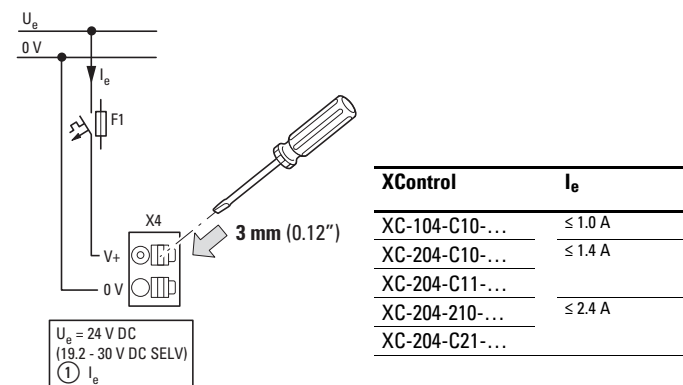

Figure 32: Connecting the XC-104-..., XC-204-... power supply

The Modular PLCs XControl: XC-104-..., XC-204-..., XC-303-... power the system bus.

XC-303-...	5 VDC/1.6A and 24 VDC/1.6 A
XC-204-...	5 VDC/0.8A and 24 VDC/0.8A
XC-104-...	5 VDC/0.4A and 24 VDC/0.4A

The system bus communication channel on the XN300 slice modules is powered with the 5 V on the Modular PLCs XControl: XC-104-..., XC-204-..., XC-303-...'s system bus.

In addition, the system bus provides a 24 VDC supply voltage used to internally power the XN300 slice modules. Modules with high power consumption levels, however, will also need an additional power supply. Some XN300 slice modules require an external 24 VDC power supply.



For more information, please refer to "XN300 slice modules".

2 Installation

2.9 Connecting local inputs/outputs

2.9 Connecting local inputs/outputs

XC-303-... and XC-204-... modular PLCs feature local inputs/outputs.

These digital inputs/outputs are configured as inputs by default. However, this configuration can be changed in the corresponding XSOFT-CODESYS-3 dialog box.

Please refer to → Section "6.1 Configuring the device's local inputs/outputs", page 93.

The inputs/outputs on the XC-204-... are not galvanically isolated and are powered by the system power supply (V+). Meanwhile, the inputs/outputs on the XC-303-... are galvanically isolated from the system power supply and require an external power supply (UL).

2.9.1 Connecting the power supply for local outputs on XC-303-...

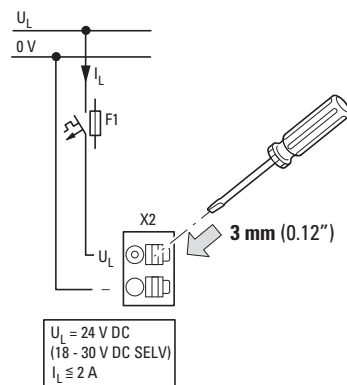

Figure 33: Connecting the power supply for outputs Q1 to Q4

The cross-sectional area of the +24 V cables used to supply power to the inputs/outputs must be sized for the maximum total current drawn by all the outputs.

2.9.2 Connecting outputs

A maximum current of 0.5 A is permissible per output. The outputs are short-circuit proof to 24 VDC and GND.

If a short-circuit or overload occurs at one of the digital outputs, the output will be switched off. Once the short-circuit or overload condition is fixed, the output will automatically switch back on.

An LED is assigned to each output. A switched (active) output will be indicated by the LED showing a green light.

Connect the outputs, unshielded, with a connection cable with a maximum length of 30 m.

Designation	Number of outputs	Current/output[kb] [mA]	Max. total current [A]
XC-303-C32-002	4	500	2
XC-303-C21-001	–	–	–
XC-303-C11-000	–	–	–
XC-204-C20-002	–	–	–
XC-204-C21-001	–	–	–
XC-204-C11-003	2	500	1
XC-204-C10-000	2	500	1
XC-104-C10-000	–	–	–

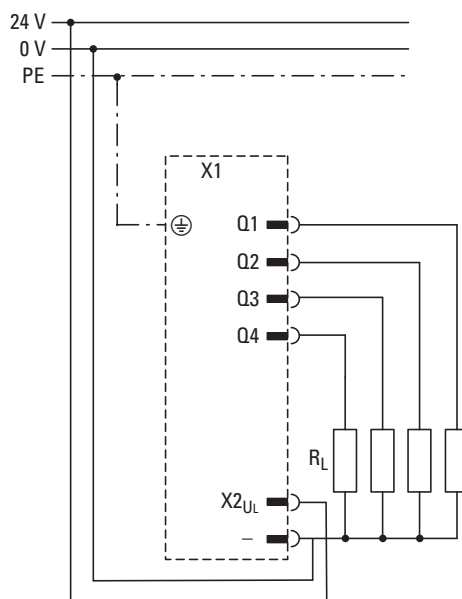

Figure 34: Connecting the local outputs of an XC-303-...PLC

2 Installation

2.9 Connecting local inputs/outputs

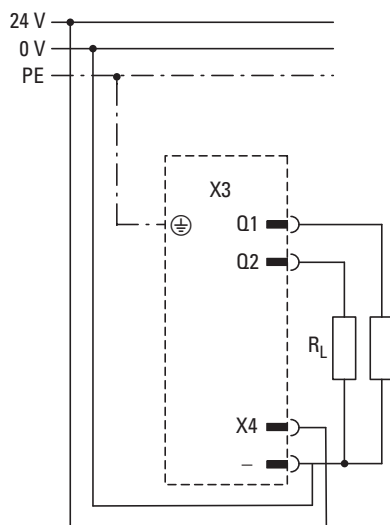

Figure 35: Connecting the local outputs of an XC-204...PLC



For wiring examples, please refer to the "XN300 Slice Modules" manual.

2.9.3 Suppressor circuit for inductive loads

High induced voltages may be produced when inductive loads are switched off.

In order to prevent system malfunctions caused by voltage peaks (e.g., coupling on analog cables), it is recommended to use a suppressor circuit (RC suppressors or flyback diodes) directly on inductive loads.

2.9.4 Connecting inputs

XControl features inputs with a +24 V level that can be used to read signal states "0" and "1". The modules feature input filters designed to suppress glitches on the corresponding signal cables.

Inputs I1 to I4 can be parameterized as interrupt inputs.

Connect the inputs with a shielded connection cable with a maximum length of 30 m.

An LED is assigned to each input in order to indicate the input's current state.

2 Installation

2.9 Connecting local inputs/outputs

Designation	Number of inputs	Can be configured as an interrupt input
XC-303-C32-002	4	✓
XC-303-C21-001	–	–
XC-303-C11-000	–	–
XC-204-C20-002	2	✓
XC-204-C21-001	2	✓
XC-204-C11-003	–	–
XC-204-C10-000	–	–
XC-104-C10-000	–	–

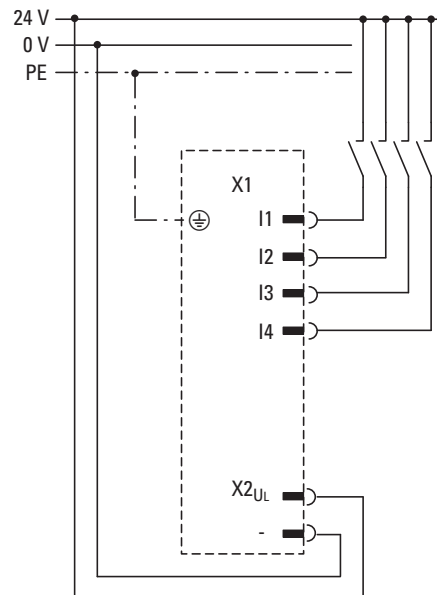

Figure 36: Connecting XC-303-... local digital inputs

2 Installation

2.9 Connecting local inputs/outputs

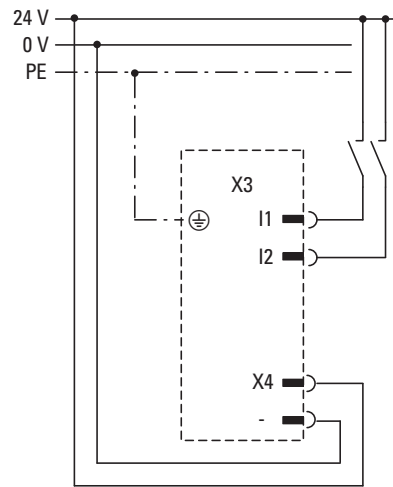

Figure 37: Connecting XC-204-... local digital inputs

2.9.5 Using inputs as interrupt inputs

The inputs can be configured as interrupt inputs in the corresponding XSOFT-CODESYS-3 parameter dialog box.

The interrupts can be triggered with a rising or falling edge or simply with any edge.

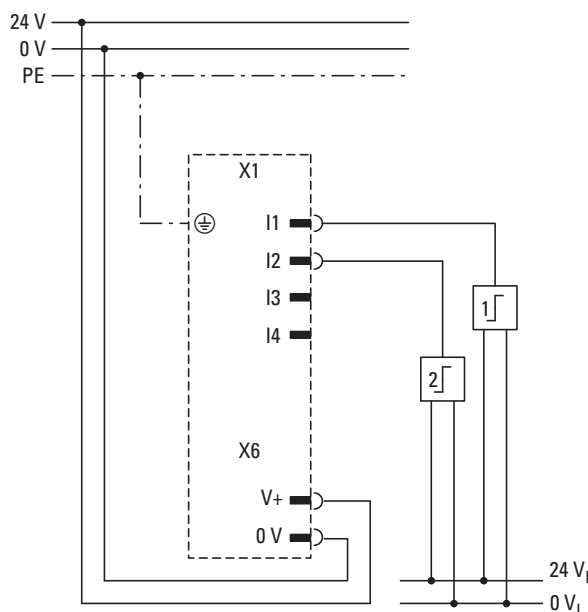

Figure 38: Interrupt input connections

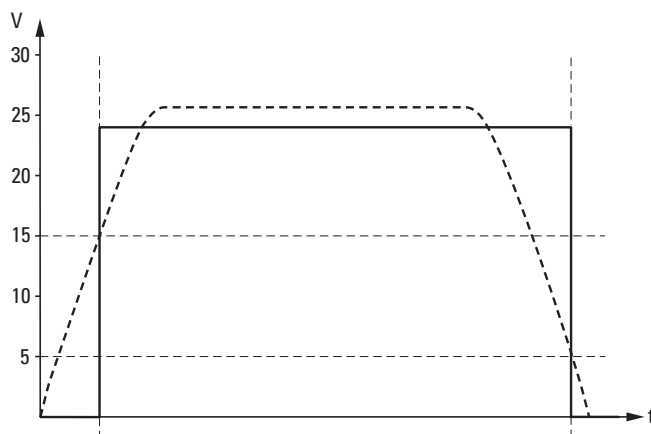

Figure 39: Switching thresholds for inputs in conformity with EN 61131-2

See also:

- Timing requirements for the interrupt inputs: Technical data → Page 172

2 Installation

2.9 Connecting local inputs/outputs

3 Commissioning

The Modular PLCs XControl: XC-104-..., XC-204-..., XC-303-... need to be commissioned together with the XN300 slice modules in the corresponding system block.



For more information, please refer to the "XN300 slice modules" manual.

3.1 General commissioning instructions

The signals received by analog modules are very small in comparison to digital signals. In order to ensure that these modules work properly, it is absolutely necessary to route all cables carefully:

- The DIN-rail must have a proper earth connection
- The cables used to connect to the analog signal sources must be as short as possible and must not be routed parallel to digital signal cables.
- Analog signal cables must be screened.
- The screening must be terminated at a screening bus.
- Do not route the input cables parallel to load circuits.
- Suppressor circuit for all contactor coils (RC suppressors or flyback diodes)

3.2 USB interface activation for XC-104-... and XC-204-... devices



Requirement:

You will need admin rights in order to be able to activate the interface!

Due to safety reasons, the USB interface on the device is disabled by default. To activate the USB interface, follow the steps below:

- ▶ Connect your PC to the device with a Cat5 (or higher) standard Ethernet patch cable with RJ45 plug connectors.



Make sure to use the ETH0 port on the device only!

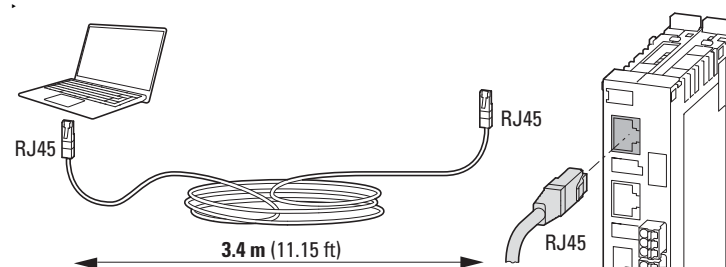





Figure 40: Connecting the PC to the XControl ETH0 port with a standard Ethernet patch cable

3 Commissioning

3.2 USB interface activation for XC-104-... and XC-204-... devices

- ▶ Set the IP address for the Ethernet port on the PC or the USB/Ethernet adapter (if any) to the same number range as that of the default IP address of the ETH0 port on the XC-104-... or XC-204-... device! If you are connecting the device for the first time, you will only be able to do this if you change the PC's IP address.

Changing the PC's IP address

- ▶ Click on the  Start menu on your PC and then on  Settings
- ▶ Click on  Network & Internet.
- ▶ Click on "Properties."
- ▶ Select Internet Protocol Version 4 (TCP/IPv4) and click on the "Properties" button.
- ▶ In the "Internet Protocol Version 4 (TCP/IPv4) Properties" dialog box, enter a fixed IP address for the PC. This IP address must be in the same number range as the device's default IP address, but must not be the same as the latter. 192.168.119.xxx, e.g. 192.168.119.100.
- ▶ Enter subnet mask 255.255.255.0.

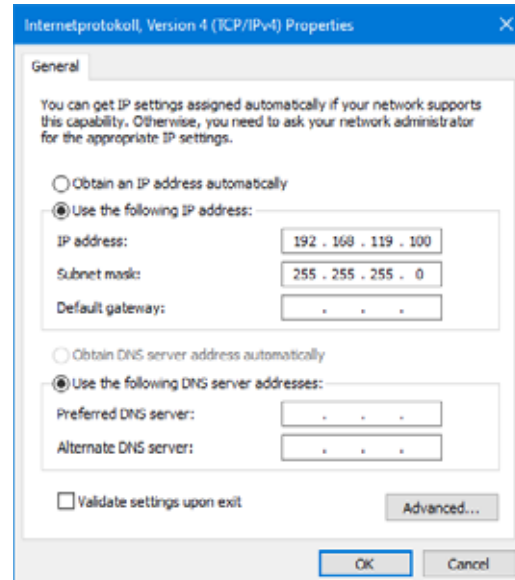

- ▶ Confirm with OK.
 - ▶ Switch on the power supply at the device.
 - ▶ Open a web browser on your PC (preferably Chrome).
- ➔ Please note that Internet Explorer is not supported.

- ▶ Enter the device's default IP address into the address bar;
<https://192.168.119.204:8375>
The login screen will appear.

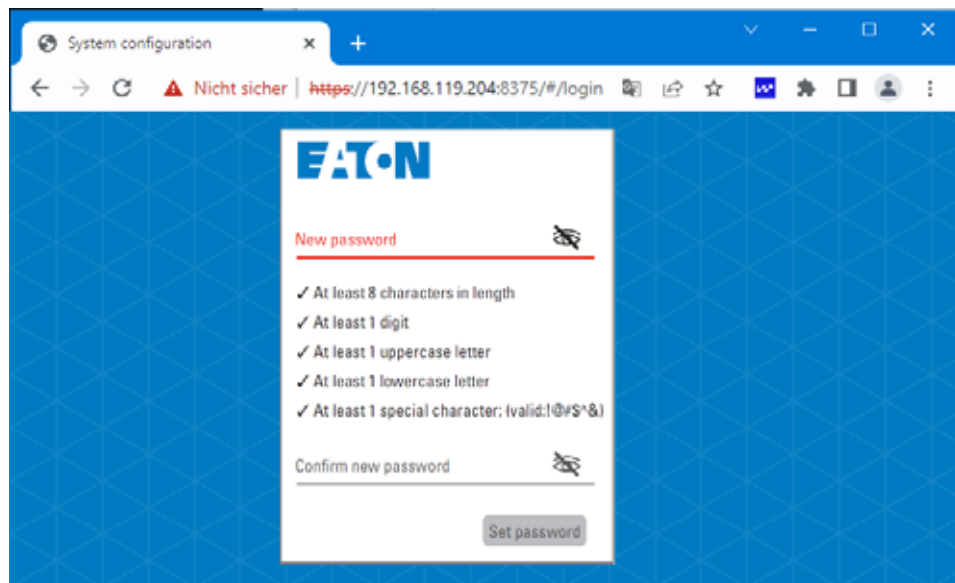

- ▶ Log in and create a password.



Do not forget to write the password down!
As the first user, you will automatically be set up as the administrator.

The "System configuration" screen will appear.

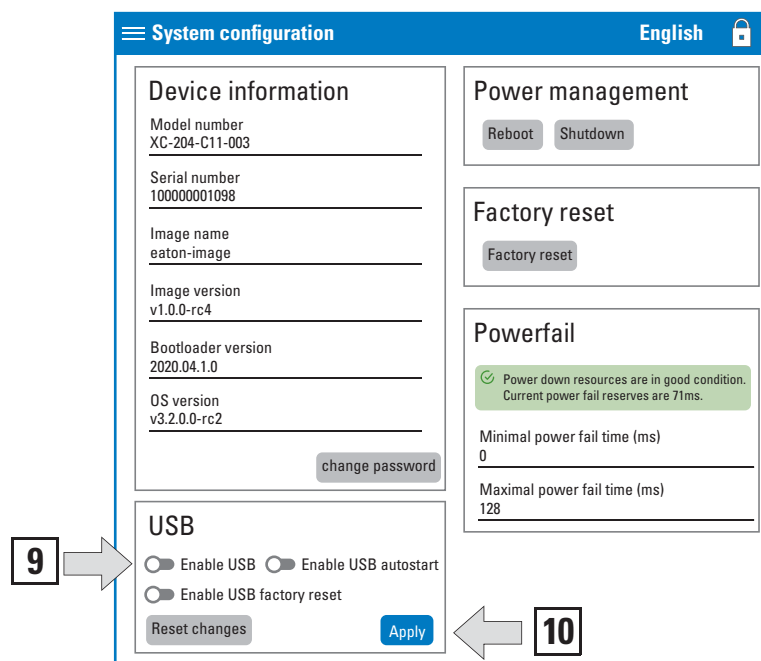

- ▶ In the USB section, click on the "Enable USB" toggle switch.
- ▶ Click on "Apply."

3 Commissioning

3.3 Startup behavior XC-104-..., XC-204-..., XControl



Figure 41: Activated USB interface

The USB interface is now activated and can be used.

3.3 Startup behavior XC-104-..., XC-204-..., XControl

To update the operating system/user program, the drives will be checked for updated versions. If any updated versions are found, they will be copied to internal memory.

The following flow diagrams show which program is used. The diagrams also show how the operating system (OS) can be updated with the MicroSD memory card or USB Host.

The device will be restarted and will start with the updated operating system and, if applicable, a stored boot application.

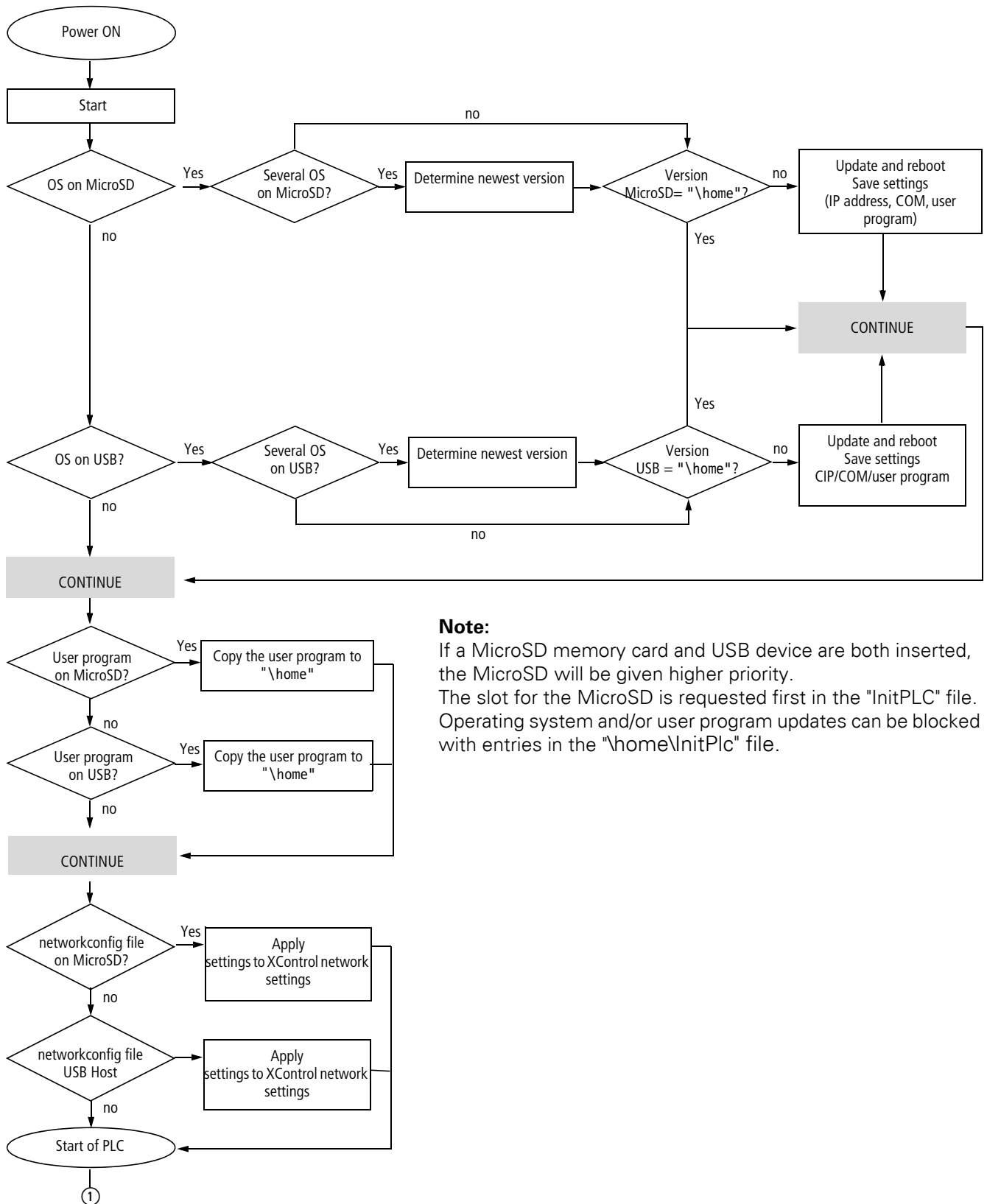

Note:

If a MicroSD memory card and USB device are both inserted, the MicroSD will be given higher priority. The slot for the MicroSD is requested first in the "InitPLC" file. Operating system and/or user program updates can be blocked with entries in the "\home\InitPlc" file.

Figure 42: Startup sequence for XControl with MicroSD memory card and USB Host

3 Commissioning

3.4 Program execution

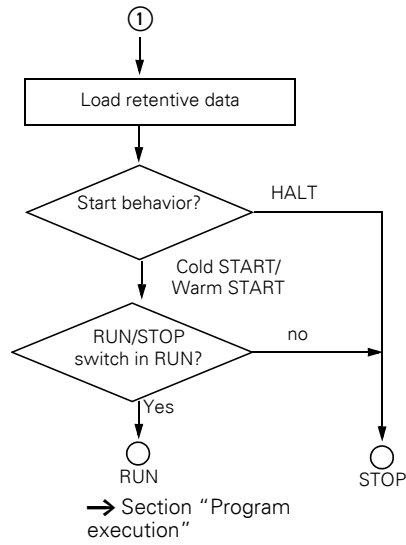

Note:
The XControl's startup behavior is configured in "\home\InitPlc".

3.4 Program execution

The program's execution can be influenced with the position of DIP switch S1.

3.4.1 DIP switch S1

The STOP DIP switch changes the CPU operating state with ON/OFF.

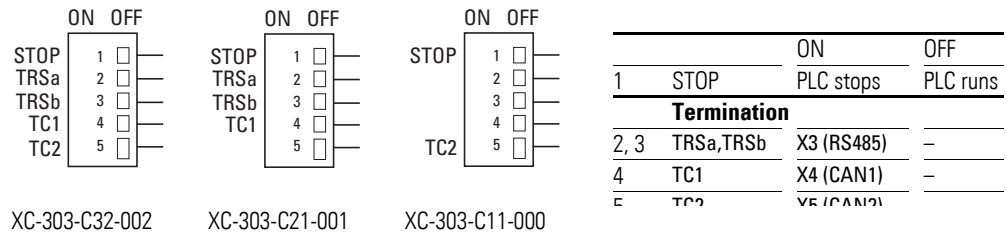

Figure 43: Device-model-specific configuration: DIP switch S1 for XC-303-...

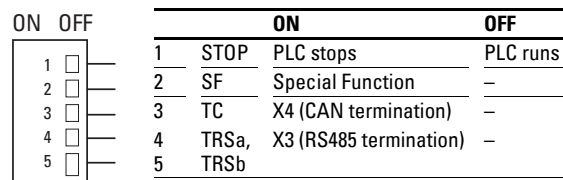

Figure 44: Configuration of DIP switch S1 for XC-104-..., XC-204-...

3.4.2 DIP switch S2

DIP switch 2 has a special function for XC-104-... and XC-204-... devices. In the ON state, the device sends responses to broadcast requests from the discovery service.

① S1		ON	OFF	ON	OFF
1	<input type="checkbox"/>	1	STOP	PLC stops	PLC runs
2	<input type="checkbox"/>	2	SF	Special Function	Discovery
3	<input type="checkbox"/>	3	TC	X4 (CAN termination)	–
4	<input type="checkbox"/>	4	TRSa,	X3 (RS485 termination)	–
5	<input type="checkbox"/>	5	TRSc		

Figure 45: XC-104-..., XC-204-...

3.4.3 Program start (STOP → RUN)

You have the following possibilities to start the program:

	Program exists in main memory	Program should be loaded
Prerequisite	<ul style="list-style-type: none"> • CPU in STOP • STOP switch ON 	<ul style="list-style-type: none"> • CPU in STOP • STOP switch OFF
Action	<ul style="list-style-type: none"> • Switch the STOP switch to OFF 	<ul style="list-style-type: none"> • Load program • in online operation, issue the "Start" command.
Result for all variables	CPU in RUN Values are retained at the start	CPU in RUN Initial values are activated

3.4.4 Program stop (RUN → STOP)

A change of the DIP switch to the ON position leads the central processing unit to the STOP state after completion of the program cycle (ending of all active tasks).

The PLC settings under the XSOFT-CODESYS-3 Device tab are used to define what should happen in the CPU's STOP state.

Default setting:

- In the "Always update tags" field: "Disabled (update only if used in a task)"
- In the "Behavior for outputs in Stop": "Keep current values."

This will ensure that the values of the outputs used in the I/O tasks will be kept after the tasks end.

When running tests and simulations, the "Enabled 1 (use bus cycle if not used in any tasks)" option should be selected in the "Always update tags" field. This is the only way to ensure that all inputs and outputs will be shown with their latest state in the simulation.

You can stop the program in one of two ways:

- In online operation, issue the STOP command.
- Switch the STOP DIP switch to the ON position.

3 Commissioning

3.5 Power off/Interruption of the power supply

3.5 Power off/Interruption of the power supply

When the program is running, the switching off or interruption of the (CPU) power supply will cause the program cycle or all tasks to be aborted immediately. If this happens, data consistency will no longer be guaranteed!

All outputs in which the I/O tasks are used are set to 0 or switched off. The behavior of retentive variables is shown in Table 9.

The remaining program cycle will not be completed when power is reconnected!

If data consistency is absolutely necessary for an application, additional measures are required, such as the use of a uninterruptible power supply with battery back-up. The PLC is started as shown in Figure 47 and Figure 42.

Table 8 How the tags behave after the program starts

Variable type	Behavior of the variables after ...	
	Cold start	Warm start
Non-retentive	Activation of the initial values	Activation of the initial values
Retain Persistent	Values remain in memory	Values remain in memory

CPU operating state display

The CPU's operating state is indicated by the status display LEDs under PLC and PRG in the front:

CPU status	LED PLC	
	Green	Red
RUN	ON	AUS
STOP	Flashes	AUS
NOT READY	AUS	ON

If the runtime system does not start properly, the PLC LEDs will signal the NOT READY state. The CPU remains in STOP state. The CPU can be restarted after elimination of the fault, see also → Section "3.6 LED indicators", page 63.

3.5.1 Test and commissioning (Debugging)

The Modular PLCs XControl: XC-104-..., XC-204-..., XC-303-... supports the following test and commissioning features:

- Breakpoint/Single step mode,
- Single cycle mode,
- Forcing,
- Online modification, → PLC programming with CODESYS manual, Chapter "Online functions",

Breakpoint/Single step mode

Breakpoints can be set within the application program. If an instruction has a breakpoint attached, then the program will halt at this point. The following instructions can be executed in single-step mode. Task monitoring is deactivated.

ATTENTION

Any outputs already set when the program reaches the breakpoint remain set!

Single cycle mode

In single-cycle operation, one program cycle is performed in real time. The outputs are enabled during the cycle. At the end of the cycle, the output images are cancelled and the outputs are switched off. Task monitoring is active. Task monitoring is active.

3.5.2 Forcing

All user program tags can be initialized with default values. A local output is only forced if the corresponding variable is assigned by default and the central processing unit is in the RUN state.

Flag Display

The inputs/outputs are to be referenced in order to visualize the states of the configured inputs/outputs in an interval controlled task in the PLC configurator. The following syntax is sufficient in the ST programming language in order to be able to display individual I/O bits.

Example:

```
%IB0; (referencing of inputs I0.0 - I0.7)
%QB0; (referencing of outputs Q0.0 - Q0.7)
```

In the instruction list (IL):

```
LD   %IB0
ST   Default byte
LD   Default byte
ST   %QB0
```

3 Commissioning

3.5 Power off/Interruption of the power supply

3.5.3 Reset

There are three different types of Reset commands:

- Warm reset,
- Reset cold,
- Full reset.

Table9: The commands also affect the state of the CPU: shows the commands to use for initializing a retentive variable range. The commands also affect the state of the CPU.

Table 9 Behavior of the program and the variables after a Reset

Variable type	Reset command		
	Warm reset	Reset cold	Full reset ¹⁾
Non-retentive	Activation of the initial values	Activation of the initial values	Activation of the initial values
Retain Persistent	Values remain in memory	Values remain in memory	
Program	Is stopped; then restarted	Is stopped; then restarted	Is deleted; PLC in NOT READY state; the PRG LED turns off; then load the program onto the device again and start it

1) After "Full reset," the program must be loaded onto the XControl again. In online operation, the "Start" command can now be issued.



For more information, please refer to the XSOFT-CODESYS-3 Online Help using "RETAIN" as a keyword.

3.6 LED indicators

The status display LEDs in the front are used to indicate the signal states of the Modular PLCs XControl: XC-104-..., XC-204-..., XC-303-..., the interfaces, and the inputs and outputs.

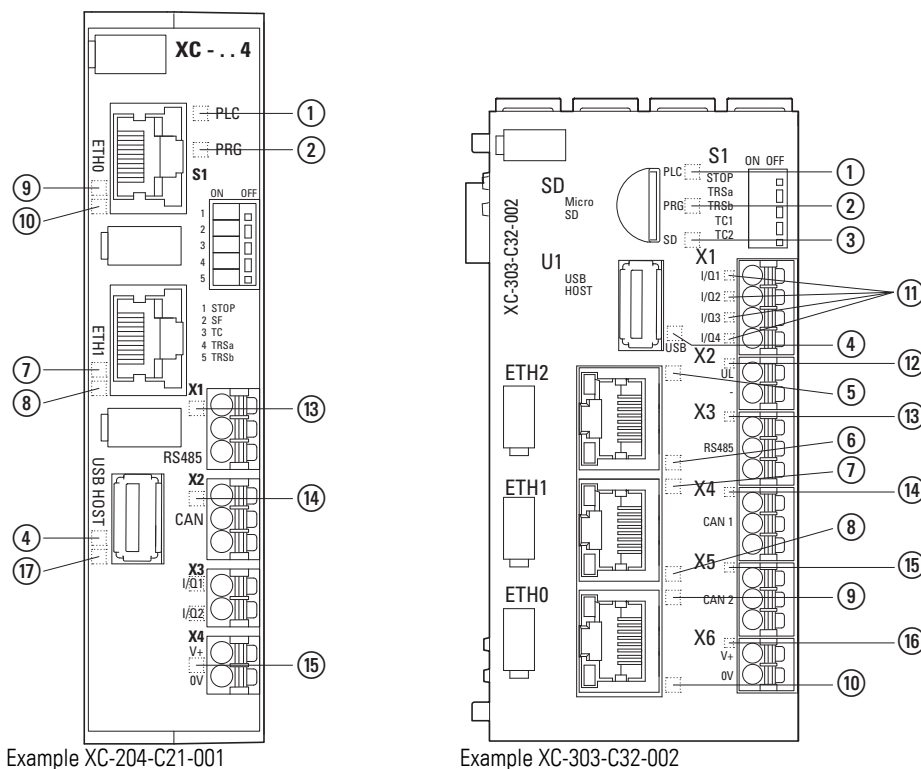

Figure 46: LEDs using XC-204-... and XC-303-... as an example

- ① PLC LED: RuntimeSystem loaded (green)/
active communication with programming system (green blinking)
RUN (green)/STOP (blinking green)/ERROR (red)
- ② LED PRG (red)/No Error(green)
- ③ MicroSD detected LED (green/-)
- ④ USB active LED (green/-)
- ⑤ LED Ethernet2 Activity (green)
- ⑥ LED Ethernet2 Activity ETH1 [10/100]Mbps (orange)/1000Mbps (green)
- ⑦ LED Ethernet1 Activity (green)
- ⑧ LED Ethernet1 Activity ETH1 [10/100]Mbps (orange)
- ⑨ LED Ethernet0 Activity (green)
- ⑩ LED Ethernet0 Activity ETH1 [10/100]Mbps (orange)
- ⑪ LED Q1-Q4 (green)
- ⑫ U_L 24V detected LED (green)
- ⑬ LED RS485 connected (green/ red)
- ⑭ CAN1 connected LED (green/ red), flashes during data transfers (Rx + Tx)
- ⑮ CAN2 connected LED (green/ red), flashes during data transfers (Rx + Tx)
- ⑯ V+ 24 VDC detected LED (green)
- ⑰ USB controller accessing storage device LED

3 Commissioning

3.6 LED indicators

Table 10 LED status display

	Status LED			Description
	red	green	orange	
PLC	–	–	–	RuntimeSystem not started <ul style="list-style-type: none"> No power on X6
	–	Flashes	–	Communication
	–	ON	–	PLC RuntimeSystem started
	ON	–	–	Error status of the RuntimeSystem <ul style="list-style-type: none"> Hardware Error Checksum Error Could not start SSL connection Fix: Check the log file
	ON	ON	–	RuntimeSystem has started and is signaling an error condition.
PRG	–	–	–	No application on device
	–	ON	–	Application running
	–	Flashes	–	Communication (green blinking)
	ON	Flashes	–	Application stopping; program signaling error condition Because of the following, for example: <ul style="list-style-type: none"> Unsuccessful data access Task interval time > Watchdog time
	–	Flashes	–	Application stopping
SD	–	–	–	No MicroSD memory card detected
	–	ON	–	MicroSD memory card detected
USB	–	–	–	No USB Host detected
	–	ON	–	USB Host plugged in
	–	–	ON	XC-204-..., XC-104-...: Current access operation on storage device.
RS485	–	–	–	
	–	ON	–	Communication channel open
	–	Flashes	–	Bus activity
CAN1 CAN2	–	–	–	No bus activity
	–	Flashes	–	Bus activity OK (CAN), FLASHES with every frame
	ON	–	–	Bus error
	Flashes	Flashes	–	Warning
	red	green	orange	
ETH0...ETH2	–	–	–	No active connection
	–	ON	–	Active connection
	–	ON	Flashes	Active connection and data being received or transmitted
Ethernet Activity	–	–	–	Ethernet communication / link status
	–	ON	–	
	–	–	ON	
	–	ON	ON	

1) Flashes: The flashing frequency can vary depending on the transfer rate on the bus.
When there are large volumes of data, the flashing will look like a solid green light on the LED.

	Status LED			Description
	–	Green	–	
Q1...Q4	–	–	–	There is a LOW signal at the input.
	–	ON	–	Input has a HIGH signal
POW	–	–	–	No power on X6
	–	ON	–	24 VDC power for device present at X6
U _L at Q1...Q4	–	–	–	No power
	–	ON	–	Power supply present

1) Flashes: The flashing frequency can vary depending on the transfer rate on the bus.
 When there are large volumes of data, the flashing will look like a solid green light on the LED.

3.7 Operating states when the XControl starts

PLC and PRG are used to indicate the operating states.

3.8 Programs and project

3.8.1 Loading programs onto the device

You must log on in order to load recently created or modified programs onto the device. The question "Load the new program?" will appear. The load operation will start once this prompt has been confirmed.



Please note that the "Retain" variables are initialized during the load process, but the "PERSISTENT" variables retain their value.

In order to safely store the program, a boot application must be generated by the user program. The "Create boot application" command will load the program from the PC onto the system memory and save it as a boot application in a non-volatile manner.

To create a boot application, follow the steps below:

- ▶ Change over to the "Online" folder.
- ▶ Select the "Login" command.
- ▶ Select the "Create boot application" command.

Alternatively, you can configure XSOFT-CODESYS-3 in such a way that a boot application will be generated automatically when the user program is downloaded. To automatically generate a boot application during the download, follow the steps below:

- ▶ Select "Application" in the browser.
- ▶ Select the "Properties" option in the context menu.
- ▶ Open the "Boot Application" tab.
- ▶ Enable the "Implicitly generate boot application during download" option.

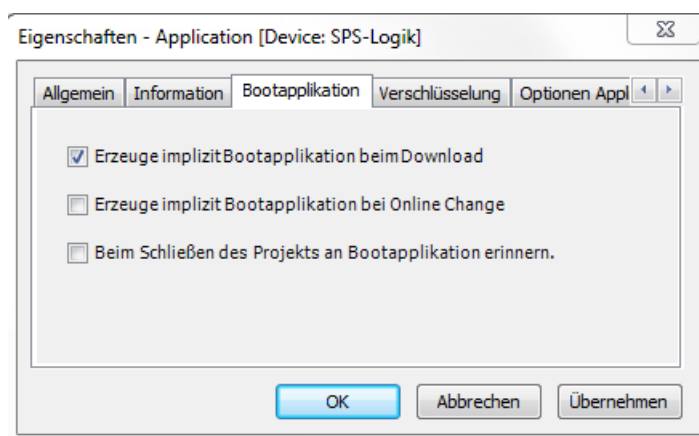

3.8.2 Saving and deleting a boot application.

Saving a boot application on the MicroSD memory card

- ▶ Make sure that communications with the XControl device have been established.
- ▶ Make sure that the boot application was compiled without errors.
- ▶ Make sure that the microSD card is inserted into the device.
- ▶ In Explorer, double-click on the device (e.g., "Device (XC-303)") and select "PLC Shell" under the "Device" tab.
- ▶ Enter the `copyprojtosd` command into the command line.

An "XC303" directory with a "project" subdirectory will be created for the boot application. The boot application will be named `<application_name>.app` ("Application.app", for example) and stored in this subdirectory. In this case, `<application_name>` refers to the application in Explorer. In addition, an `<application_name>.crc` file will be generated.

The boot application will be stored on the MicroSD memory card in the aforementioned directory structure.

You can use the `copyprojtosd` PLC shell command to copy the boot application (e.g., for a backup copy) or change the file's name. However, only the boot application named `<application_name>.app` will be active in the XSOFT-CODESYS-3 software.

Saving a boot application on the USB device

- ▶ Make sure that communication with the device has been established.
- ▶ Make sure that the boot application was compiled without errors.
- ▶ Make sure that there is a USB device plugged into the USB Host.
- ▶ In the configuration tree, double-click on the device (e.g., "Device (XC...)") and select "PLC Shell" under the "Device" tab.
- ▶ Enter the `copyprojtousb` command into the command line.

An "XC..." directory with a "project" subdirectory will be created for the boot application. The boot application will be named `<application_name>.app` ("Application.app", for example) and stored in this subdirectory. In this case, `<application_name>` refers to the application in Explorer. In addition, an `<application_name>.crc` file will be generated.

The boot application will be stored on the USB device in the aforementioned directory structure.

You can use the `copyprojtousb` PLC shell command to copy the boot application (e.g., for a backup copy) or change the file's name. However, only the boot application named `<application_name>.app` will be active in the XSOFT-CODESYS-3 software.

Deleting a boot application from the MicroSD

Click on the "Device → PLC Shell" folder and enter the `remprojfromsd` command for the XControl.

3 Commissioning

3.9 Updating the operating system

Deleting a boot application from the USB device

Click on the "Device → PLC Shell" folder and enter the `remprojfromusb` command for the XC....

3.9 Updating the operating system

With the Modular PLCs XControl: XC-104-..., XC-204-..., XC-303-... it is possible to replace the operating system with the latest version.



If you transfer a current operating system to an older hardware version, it is possible that not all functions of the operating system will be supported by the hardware.



When an operating system is loaded onto the PLC, the existing operating system will be overwritten!



Observe the information in the corresponding release notes, which are also available from the Download Center.

The operating system is updated exclusively within the XSOFT-CODESYS-3 programming system.

A *.tar file is installed on the device for this purpose.

For XC-104-... and XC-204-... devices, the operating system can be additionally updated with the Web Config Tool.

Individual operating system components can be installed separately for these devices:

1. Operating system Linux
2. Bootloader
3. PLC Runtime System

3.9.1 Updating the operating system with the Web Config Tool

For more information, please refer to → Section "14.6 Update configuration page", page 145.

3.9.2 Updating the operating system with the XSOFT-CODESYS-3 programming system

Procedure:

- ▶ Establish a connection to the modular PLC with the PC's Ethernet interface.
→ Chapter 5 "Connection set-up PC – Modular PLCs XControl: XC-104-..., XC-204-..., XC-303-...", page 89.
- ▶ Go to the "Device" screen in XSOFT-CODESYS-3 and open the "Firmware" tab.

3 Commissioning 3.9 Updating the operating system

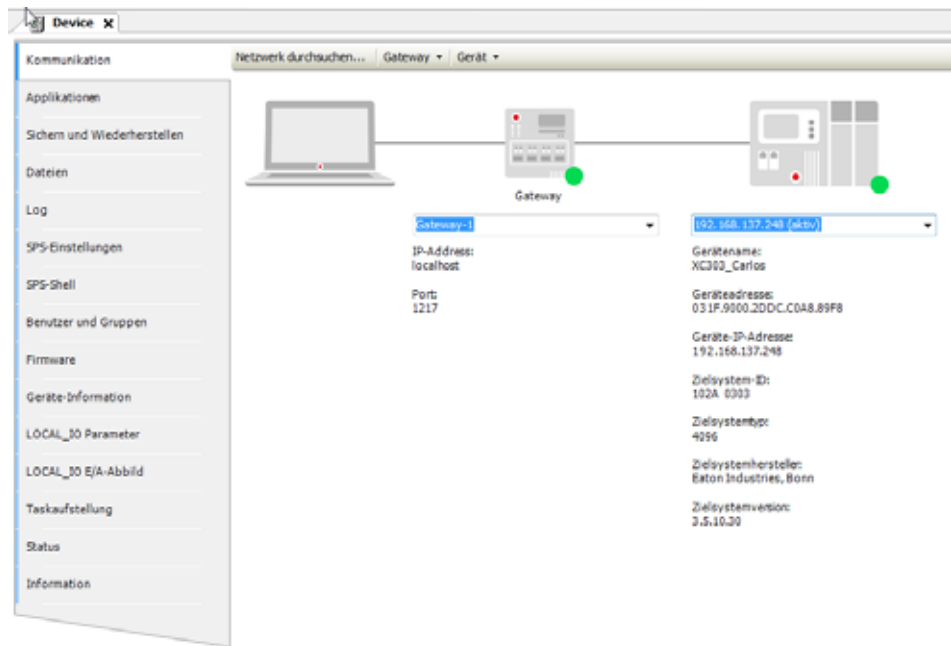

Figure 47: "Device" screen

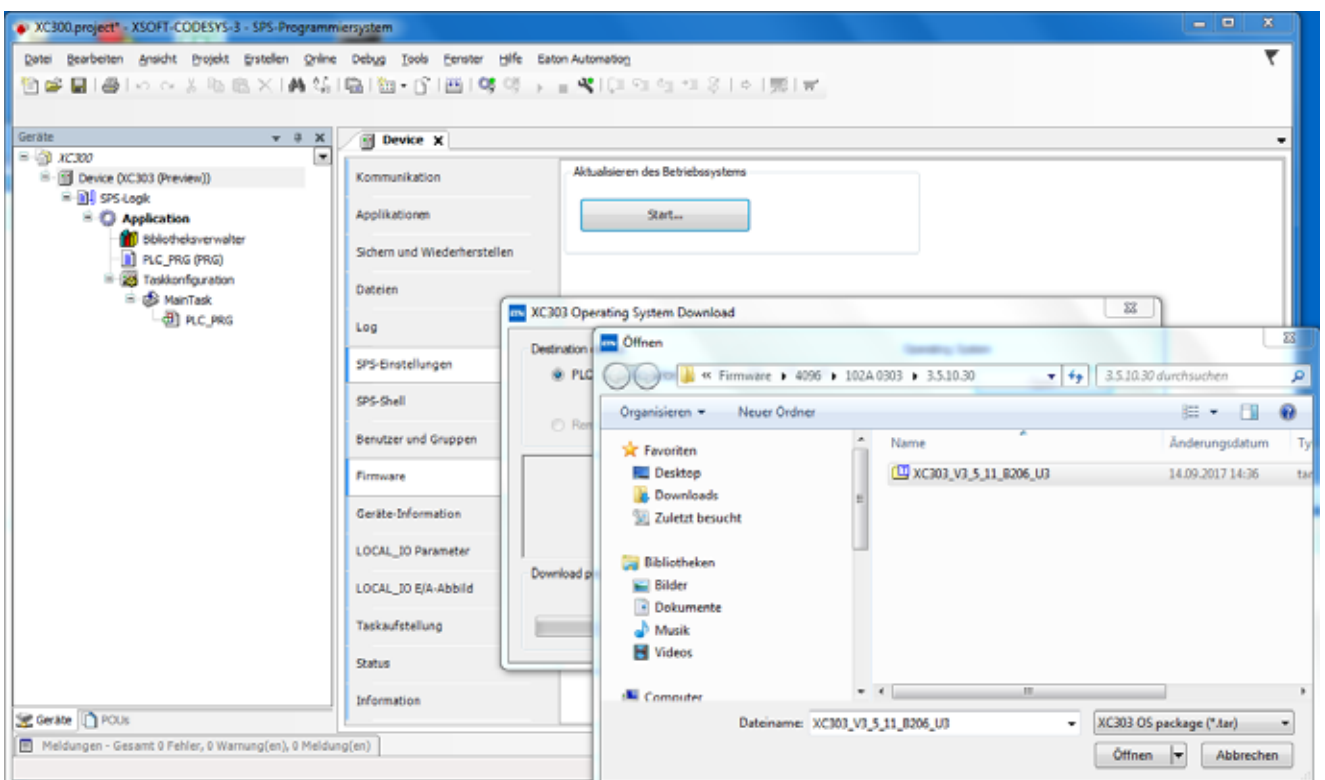

Figure 48: "FTP installation" window for XC-303-...

- ▶ Enter the PLC's IP address and click on "Next."
- ▶ Select the "XC303" device type and click on "Next."
- ▶ Select the components you want to install:
 - For XC-303-... devices: "PLC operating system".

3 Commissioning

3.9 Updating the operating system

- For XC-104-... and XC-204-... devices:
"Bootloader"
"Linux"
"PLC Runtime System".

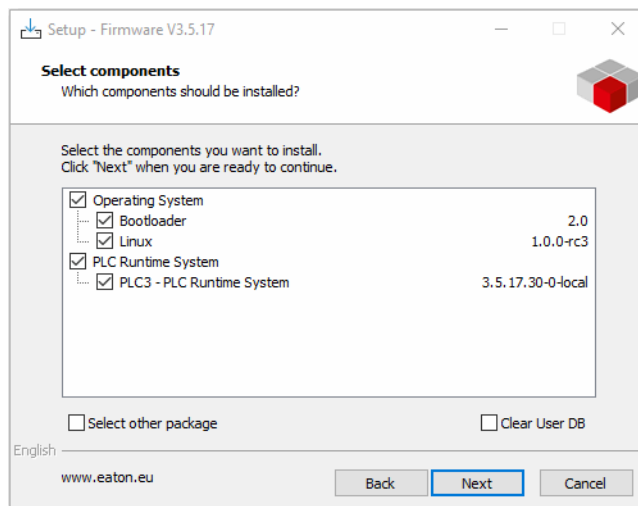

- ▶ Click on the <Continue> button.
- ▶ Stop the PLC
Switch the S1 Stop DIP switch to ON
- ▶ Click on "Download" to start downloading the firmware.
- ▶ Wait until the dialog box shows a message saying "Download successful."
Then close the window with "RETURN."
- ▶ Click on "close" to exit the Setup Wizard.
- ▶ Start the PLC
Switch the S1 Stop DIP switch to OFF
- ▶ Restart the Modular PLCs XControl: XC-104-..., XC-204-..., XC-303-....

The update process when using removable media or a local directory (→ Figure 48, page 69) is similar to that for FTP installation.

Procedure:

- ▶ Insert the USB device or MicroSD memory card into the PC.
- ▶ Select "Removable Drive" in the "XC... OperatingSystem Download" screen (→ fig. 48).
- ▶ Select the removable media directory and click on "Next."
- ▶ Select the "XC303" device type and click on "Next."
- ▶ Select the "PLC operating system" component and click on "Next."
- ▶ Click on "Install" to start downloading the firmware.
- ▶ Click on "Done" to exit the Setup Wizard.

The firmware files will be found in a directory on the removable medium called **XC.../Firmware**.

- ▶ If you want to use the device's USB port, make sure that you have activated it – please refer to → Section "3.2 USB interface activation for XC-104-... and XC-204-... devices", page 53.

- ▶ Insert the USB device or the MicroSD memory card into the modular PLC.

The system will check whether there is a different operating system on the removable medium. If one is found, the system will start updating the firmware. When this occurs, the status display LEDs under PLC and PRG in the front will flash alternately (green), as will SF (red).



The new firmware version will not be enabled until the PLC is restarted.

3.10 Factory resetting XC-104-... and XC-204-...

There are two ways to carry out a factory reset:

1. Factory reset with the Web Config Tool
2. Factory reset through the USB port

Use the first method if you know the access information for the device, as this is the fastest of the two options – please refer to → Section “14.4.5 Factory reset”, page 142.

You can use the second method if you do not know the password for the device. However, this method requires the preparation steps outlined below.

Method 2: Factory reset through the USB port

To do so, follow the steps below:

- ▶ Make sure that the "Enable USB factory reset" switch is enabled (i.e., in the right-hand switch position) on the Device configuration page in Web Config Tool.
- ▶ Prepare a storage device with a USB interface and store a file named "factory-reset.txt" on it.
- ▶ The only content of this file should be the device's serial number, e.g., "100000001098".
- ▶ Make sure that the device is de-energized.
- ▶ Plug the storage device into the device's USB port.
- ▶ Switch on the power supply at the device.

As soon as the storage device is connected to the device through the USB port and the device is switched on and starts booting up, the device will check whether the "factory-reset.txt" file is found on the storage device and whether the content of the file matches the device's serial number. If they do, the device will be reset to its default settings.

The "factory-reset.txt" file will then be deleted from the storage device. The "Enable USB factory reset" switch will be disabled, i.e., switched to the left-hand switch position.

All Ethernet ports will be reset to their default settings. If a password has been set, it will be deleted.

3 Commissioning

3.11 Mass production programming through MicroSD or USB

3.11 Mass production programming through MicroSD or USB

The operating system and the application can be programmed through a MicroSD memory card or USB device.

→ Section "3.3 Startup behavior XC-104-..., XC-204-..., XControl", page 56.

3.12 XN300-Assist

XN300-Assist is a planning, ordering, and commissioning program that can be used to make it easier to configure SDOs. In addition, XN300-Assist makes it possible to configure XN300 slice module parameters with processed cleartext. This configuration can be saved as an INI file and then imported into XSOFT-CODESYS-2 or XSOFT-CODESYS-3. As a result, only system-relevant SDOs, such as the enable signal for analog value transmission, still need to be configured directly in CODESYS.

XN300-Assist includes the following functions:

- Selecting modules, as well as a gateway
- Reading device parameters for the gateway and the system bus' modules
- Generating a project-specific EDS file
- Generating a project-specific INI file for XSOFT-CODESYS-2 or XSOFT-CODESYS-3
- Status indication of the inputs/outputs
- Wiring test
- Firmware Update
- Importing actual configurations
- Display of cyclical and acyclical diagnostics messages

The Online Help function provides a detailed description of how to use XN300-Assist. In order to open it, click on the "?" icon on the XN300-Assist menu bar or press the <F1> key.

4 PLC configuration

4.1 Task configuration

Processing of the project can be controlled via tasks. Each task can be assigned with a range of programs which should be run during execution of the task..

The task is defined by a name, a priority and a type which defines under which conditions a task starts. Priority and task conditions determine the sequence in which the tasks are to be processed.

You can select "cyclical" or "event-triggered" as the task condition. A cyclical task is restarted after the set interval time has elapsed. An event-triggered task is only started when the event occurs. You can also link system events such as "Start", "Stop" or "Reset" with the execution of a program.

The task priorities can be parameterized with a value from 0 to 31 where 0 is the highest priority and 31 is the lowest priority.

In principle the output image is written onto the physical outputs before every task is called and the map is read by the inputs (updating of the input/output map). The task is executed thereafter. In addition, all system activities are carried out before or after the task call. This includes for example, communication with the XSOFT-CODESYS-3 or Online changes.

Updating of the input/output image by multiple tasks is described in the Section "Multi-tasking" on Page 77.

All IEC tasks, including those with the highest priority can be interrupted by an interrupt or an event controlled task.

Time monitoring (Watchdog) can be activated for each task.



For a detailed task configuration description, please refer to the manual for programming PLCs with XSOFT-CODESYS-3

Following is an example used to illustrate the PLC-specific settings.

Creating a task (example)

First create the cyclic task "Basic" with the assigned program "Basic_prog". Then you can add the event-triggered "Param" task with the "Param_prog" program. In the program "Basic_prog" an event is programmed which invokes the "Param" task.

The following steps are necessary in order to create a task:

- Add a task
- Define the program call
- Create the program

4.1.1 Creating a cyclical task

- ▶ In the project's configuration tree, select the "Device (XC-303)" device -> "PLC Logic" -> "Application".
- ▶ Select "Task configuration" in the configuration tree.
- ▶ Select the "Add object" and "Task" options in the context menu.
- ▶ Enter in the Name field a name such as "Basic".
- ▶ Set the task in the dialog as in Figure 49.

Define the program call

With the program call you define which program is to be called with the task "Basic".

- ▶ Right-click on the icon for the "Basic" task you created previously and select the "Add object" -> "Program call" option in the context menu.
- ▶ Enter "Basic_prog" as a name into the "Add call" pane.
- ▶ Confirm the program name with "Add."

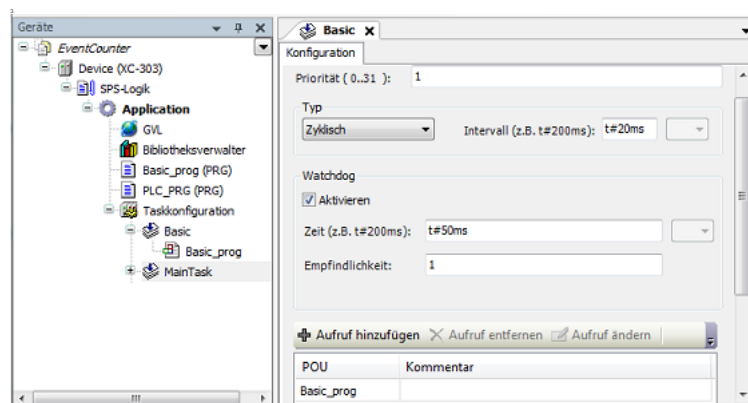

Figure 49: Configuring the cyclical task with a program call

Writing a program

- ▶ Open the editor for the "Basic_prog" POU by double-clicking on it.
- ▶ You can now enter a program. In the program example the variable "bCount" is incremented.
If the count = 20, global tag a will be set to TRUE.

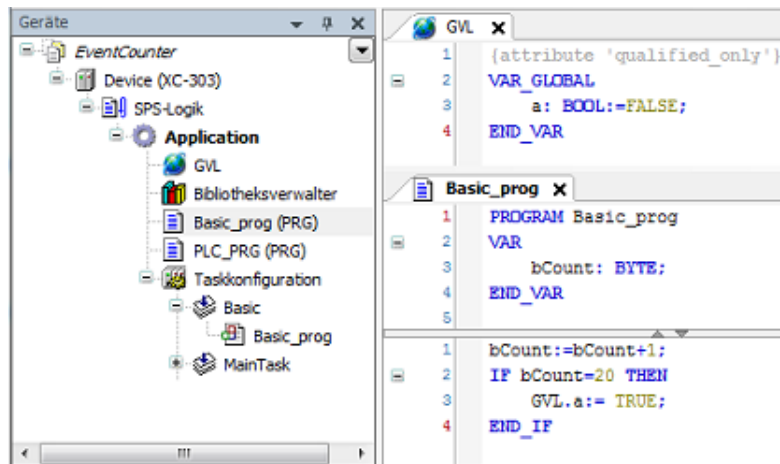

Figure 50: Creating a program element for a cyclic task

4.1.2 Creating the event-triggered task and defining the program call

The procedure corresponds to the creation of a cyclic task.

- ▶ Create a task of type "Event" named "Event" as shown in Figure 51.
- ▶ Enter global Boolean tag "a" as the event by clicking on the ... button, double-clicking on the "GVL" folder in the "Input assistance" dialog box, selecting tag "a", and confirming with "OK".
- ▶ Enter the program call "Event_prog".

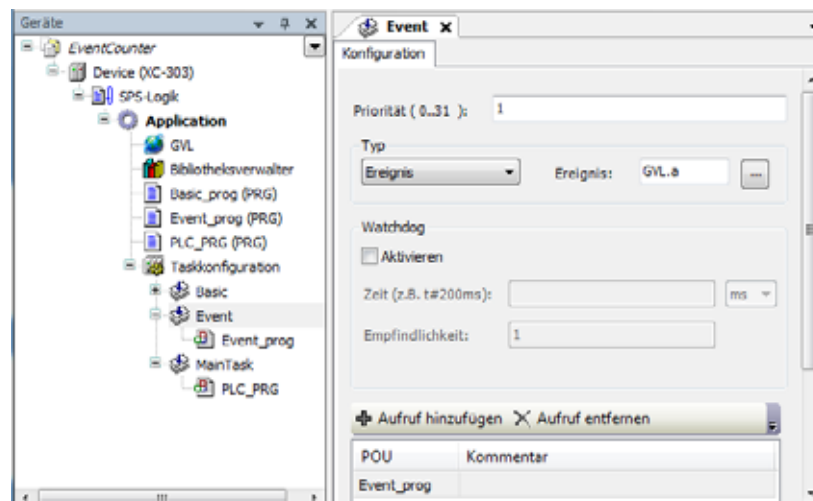

Figure 51: Creating an event controlled task

Writing a program

- ▶ Select "Application," select the "Add object" option in the context menu, and enter (POU) as an object with the name "Param_prog".
- ▶ You can now enter a program. The program example Param_prog (Figure 52) increments the variable "value" by the value 1. The Param_prog is processed if the variable a = TRUE.

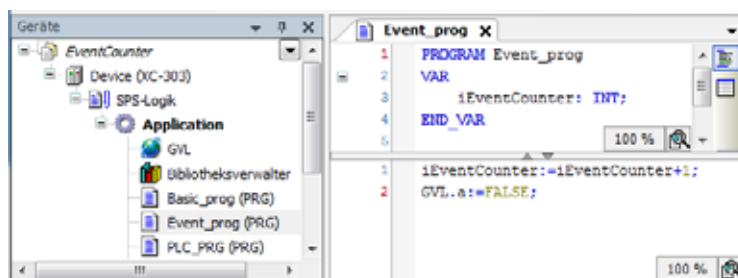

Figure 52: Programmed element for event controlled task

Events can only be triggered by Boolean tags.

4.2 System events

A function can be called with the help of a system event. It can be used when the PLC is started to initialize modules with parameters. The system events are independent of the task!

Assigning a function to a system event

- ▶ Add an event handler in the task configuration under the "System Events" tab.
 - ▶ Select one of the available events (e.g., "StartDone") and enter a function name (e.g., "AfterStart") in the "Function being called" field.
4. "System Events" - select an event (e.g., "Start") and enter the name of the POU (e.g., "Power_prog") that should be executed. **Check required**

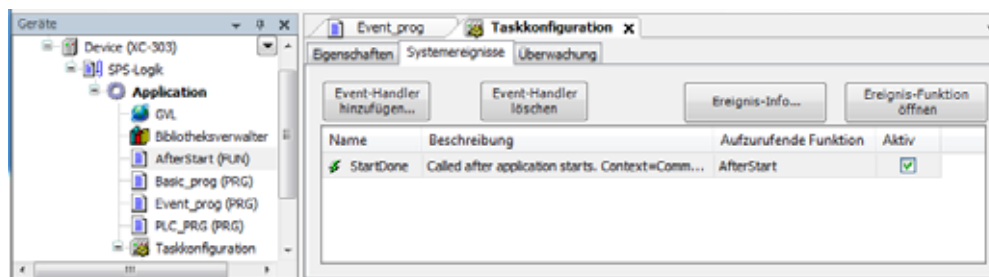

Figure 53: Assigning the function to a system event

- ▶ Double-click on the function name to open the editor and program the actions that should be taken after the start.

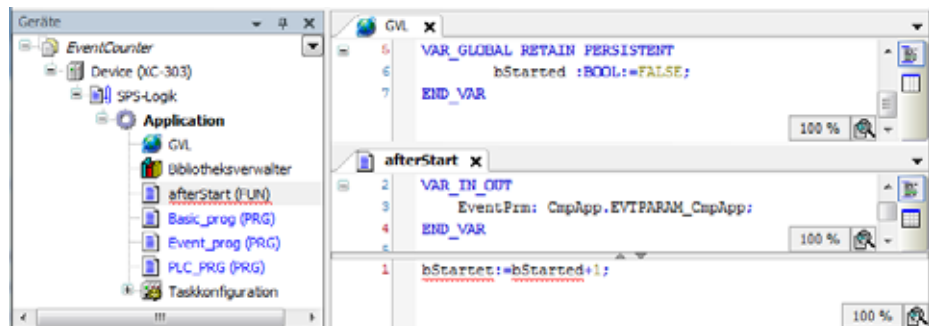

Figure 54: Programming a function



Further information concerning the system events can be found in the online help of the programming system.

4.3 Multi-tasking

The XC300 runtime system is a multi-tasking system. In other words, multiple tasks can be processed simultaneously.

Updating the input/output image table

If the local and central inputs/outputs are programmed in several tasks, the input/output image table in XSOFT-CODESYS-3 will be updated according to special rules:

By default, the only inputs read and outputs set before every task are the ones used in the task.

In other words, the CPU does not work with an unchanging input/output image table within a cycle. Instead, the input/output image table changes within the cycle based on the task.

After the start, the system updates the inputs used (e.g., in the first task). The name of the first task "Prog1" is in the Figure 56. If the system detects an input that is connected to an XN300 slice module (e.g., XN322-16DI) through the configuration, only this module input will be updated in the image table. If this task has additional inputs that are assigned to other slice modules, the inputs of these modules will be updated as well.

The same behavior applies to the outputs. If, for example, outputs QX6.0 and QX7.1 of output module "1" are addressed by different tasks, the outputs of this module will not only be updated by the first task. For instance, the first task could set output QX6.0, while the second task could reset the output based on a changed input image table.



Do not access the same input or output from different tasks.

Examples

The examples are based on the following configuration:

4 PLC configuration

4.3 Multi-tasking

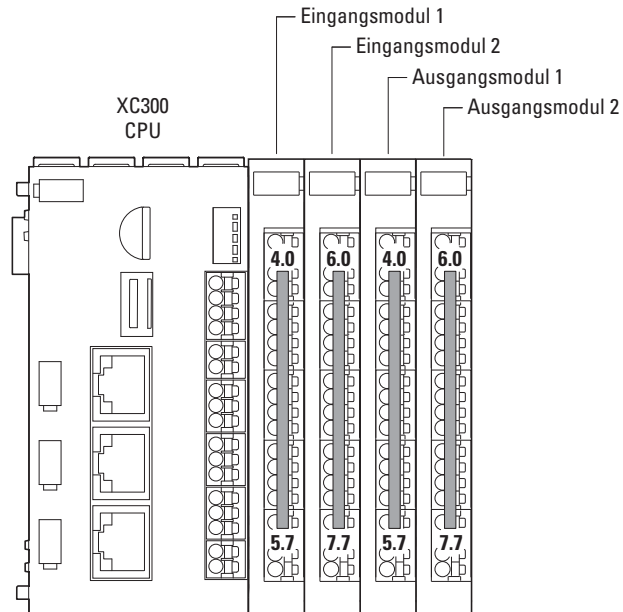

Figure 55: Configuration of MFD-Titan with local inputs/outputs and I/O system XN300 inputs/outputs as a central expansion

The task configuration now looks as follows:

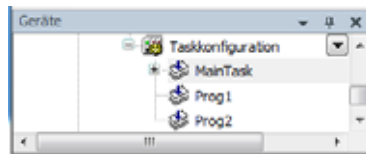

Figure 56: Task configuration for examples

Example 1:

Table 11 Task details for example 1

Task name	Priority	Cycle time
Prog 1	2	50 ms
Prog 2	1	10 ms

In the first task ("Prog1"), the "progtes(1)" program uses input IX4.0 of input module 1 and input IX6.0 of input module 2. Before the first task ("Prog1") starts, only these inputs will be updated.

In the second task "Prog2" the input IX4.1 of input module 1 is programmed in the program "progtes(2)". The input of this input module is updated before the 2nd task ("Prog2") starts.

Example 2:

Table 12 Task details for example 2

Task name	Priority	Cycle time
Prog 1	2	50 ms
Prog 2	1	20 ms

In example 2 in the first task the input IX4.0 is programmed and in the second task the input IX4.1 and output QX4.0 is programmed.

At the beginning of the first task, input IX4.0 is updated. If this input is set, output QX4.0 is set as well. Otherwise, it is reset.

At the beginning of the second task, input IX4.1 of the input module is updated and output QX4.0 is set or reset.

As a result, the control sequence could result in output QX4.0 being set in the first task and reset in the second. In other words, the output would be toggled.

Creating a task with consistent inputs/outputs

Avoid access to the physical outputs from several tasks. In order to guarantee a clear PLC sequence, create for the local inputs/outputs and the inputs/outputs of the local expansion module a task in which all inputs are copied in global variables and at the end of the interval all outputs of global variables are written to the output module (I/O update task). The I/Os are consistent (data integrity) within this task. The global variables can then be used instead of the I/Os in other tasks.



Do not access the same input or output from different tasks.



On the XC300 PLC a maximum of 50 tasks are possible. The parameterization of a task as "free wheeling" is not supported. Note with parametric programming of the watchdog time that the POU called with the interrupt service routines, extends the task run times accordingly.

4.4 Task monitoring by watchdog

The processing time of a task can be monitored in terms of time required using a watchdog. The following applies for defining the monitoring time:

$$\text{Processing time} < \text{Interval time of the task} < \text{Watchdog(time)}$$

4 PLC configuration

4.4 Task monitoring by watchdog

If the processing time of the task exceeds the interval time, the end of the second interval time is awaited until the task is restarted.

→ Watchdog inactive.

The watchdog interrupts the program processing if the processing time of the task exceeds the watchdog time.

Furthermore, the frequency (sensitivity) can be set, which the number of exceeds allows. In this case the outputs of the PLC are switched off and the user program is set to the "Halt" state. Afterwards, the user program must be reset with RESET.



If the watchdog is deactivated, there will be no task monitoring!



CAUTION

If you want to parameterize a task without a Watchdog or want to deactivate the Watchdog at a later time, all the outputs which have been accessed up to this time can continue to remain active. This is the case for example, when the task can't be ended due to a continuous loop (programming error) and/or missing end condition (stepping condition). The outputs continue to retain their "High potential" until the operating mode is changed from RUN to STOP or until the control voltage for the outputs is switched off.

Configuring a watchdog

You can select the following settings in the task configuration:

- Watchdog on/off
- Watchdog time
- Watchdog sensitivity.

These settings apply for time controlled and event controlled tasks.

Watchdog active

The watchdog is started at the commencement of every processing cycle and reset again at the end of the task.



The following rule applies for definition of the watchdog time with several tasks: each watchdog time must be longer than the sum of task interval times.

If the processing time is longer than the watchdog time (sensitivity = 1) – e.g. with a continuous loop in a program – the watchdog becomes active. If the processing cycle is shorter than the watchdog time, the watchdog is not activated.

The triggering of the watchdog continues to be dependant on the watchdog sensitivity. The watchdog sensitivity determines when the watchdog will be triggered, after the watchdog time has been exceeded by a determined number of consecutive occasions.

The watchdog is triggered:

- immediately when the watchdog time is exceeded with a watchdog sensitivity of "1",
- immediately after the "x"th consecutive time that the watchdog time is exceeded with a watchdog sensitivity of "x".

For example, a task with a watchdog time of "10 ms" and a watchdog sensitivity of "5" will end at the latest after $5 \times 10 \text{ ms} = 50 \text{ ms}$.

Example: Watchdog active

The interaction of interval time (IZ), task run time (TZ), watchdog time (WT) and watchdog sensitivity are illustrated by the following configuration example:

- Watchdog on
- Watchdog time (WT) = 15 ms
- Watchdog sensitivity = 2

The interval time (IZ) of the task is 10 ms.

Variation ①: The watchdog is not triggered as the task time always remains below the defined watchdog time.

Variation ②: The watchdog is triggered 15 ms after commencement of the second task ⚡, as both times are longer than the defined watchdog time and occur consecutively.

Variation ③: The watchdog is triggered 15 ms after commencement of the second consecutive task, which is longer than the defined watchdog time.

Variation ④; Endless loop: The watchdog is triggered ⚡, because the task time takes longer than the watchdog time multiplied by the watchdog sensitivity ($2 \times 15 \text{ ms} = 30 \text{ ms}$).

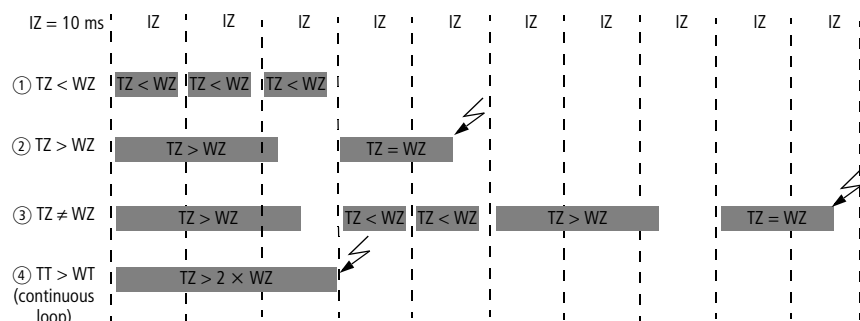

Figure 57: Watchdog active, multiple tasks with differing priority

Watchdog deactivated

The cycle time of a task is not monitored when the watchdog is deactivated. The task will be terminated once it has been completed and will not be started again until the next interval starts.

4 PLC configuration

4.4 Task monitoring by watchdog

Example: Watchdog deactivated

The interval time (IZ) is 10 ms.

Variant ①: The interval time (IT) of a task was set to 10 ms.

The actual task time (TT) is 15 ms. The task is started on the first call but is not terminated before the second cycle. Therefore, the task is not started again in the second cycle. Only in the third cycle – after 20 ms – is it possible to restart the task. The task does not run every 10 ms but rather only at a time interval of 2×10 ms.

Variant ②: The running cycle is not ended.

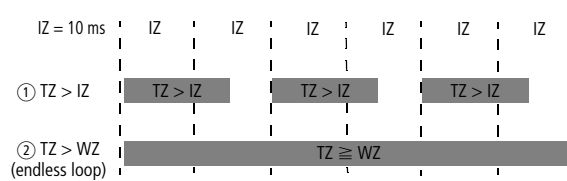

Figure 58: Watchdog deactivated

Multiple tasks with the same priority

You can assign several tasks with the same priority. The tasks are split according to the "Time Slice" principle and are practically executed simultaneously as part intervals (Round Robin).

4.5 Limit values for memory usage

The data memory of the Modular PLCs XControl: XC-104-..., XC-204-..., XC-303-... is divided into memory segments. The segment sizes are shown in Figure 59.

The global data utilizes multiple segments. The required amount can be specified to suit the size of the loaded program.

You can see the segment size under (Device (XC303) → Device Information → memory-layout):

Example:

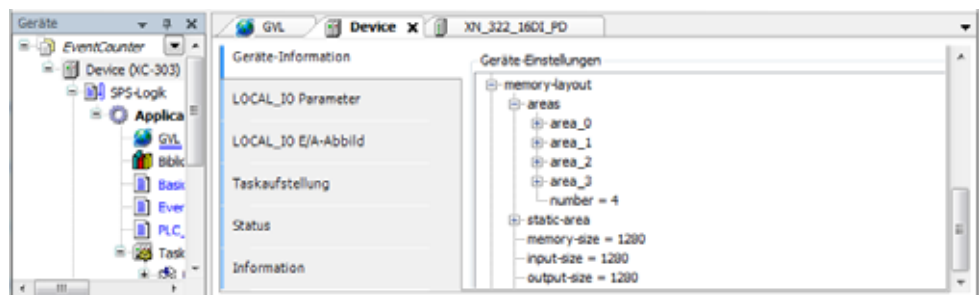

Figure 59: Device (XC-303) memory segment size

The maximum segment size for inputs, outputs, and markers is 1,280 bytes. The maximum size for retentive tags is 98 KBytes.

4 PLC configuration

4.6 Addressing inputs/outputs and marker

4.6 Addressing inputs/outputs and marker

If you open the PLC configuration of a new project, you will receive the current view of the default settings of the addressing. In this setting the addresses are automatically assigned and address conflicts (overlaps) are reported.

Variable	Kanal	Adresse	Typ	Beschreibung
XN_322_16DI_PD_1	Eingang0	%IW8	WORD	Eingangskanäle X1.1 bis X4.16
X1_1		%IX8.0	BOOL	Eingang X1.1
X1_2		%IX8.1	BOOL	Eingang X1.2
X1_3		%IX8.2	BOOL	Eingang X1.3
X1_4		%IX8.3	BOOL	Eingang X1.4
X2_5		%IX8.4	BOOL	Eingang X2.5
X2_6		%IX8.5	BOOL	Eingang X2.6
X2_7		%IX8.6	BOOL	Eingang X2.7
X2_8		%IX8.7	BOOL	Eingang X2.8
X3_9		%IX9.0	BOOL	Eingang X3.9
X3_10		%IX9.1	BOOL	Eingang X3.10
X3_11		%IX9.2	BOOL	Eingang X3.11
X3_12		%IX9.3	BOOL	Eingang X3.12
X4_13		%IX9.4	BOOL	Eingang X4.13
X4_14		%IX9.5	BOOL	Eingang X4.14
X4_15		%IX9.6	BOOL	Eingang X4.15
X4_16		%IX9.7	BOOL	Eingang X4.16

Figure 60: Default setting of the addressing

If you add a module to the PLC in the configurator, the configurator will assign this module with an address. Further modules are assigned with the next addresses in ascending order. You can also assign the addresses freely. However, if you access the "Automatic calculation of addresses" function later, the addresses are shown in reassigned ascending order.

Check for overlapping addresses

During compilation, addresses assigned twice will be detected and an error message will be generated.

Addressing by data type

If you assign an address to a word-addressable module tag (e.g., I/O system XN300 InputChannel2 on the XN322-4AI-PTNI) with the "Input address" field and this address does not match the data type (e.g., IB11), the PLC configurator will automatically show the next word address after the preceding tag (e.g., IW12).

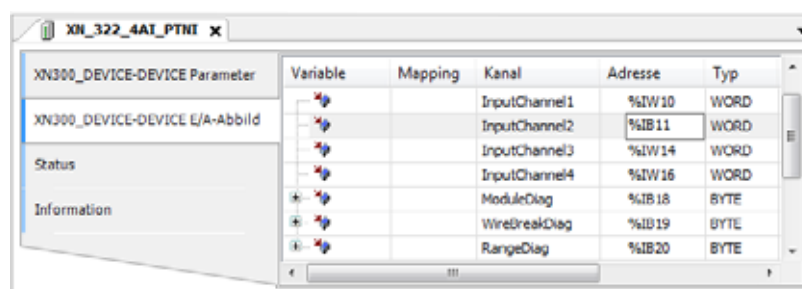

Variable	Mapping	Kanal	Adresse	Typ
InputChannel1		InputChannel1	%IW10	WORD
InputChannel2		InputChannel2	%IB11	WORD
InputChannel3		InputChannel3	%IW14	WORD
InputChannel4		InputChannel4	%IW16	WORD
ModuleDiag		ModuleDiag	%IB18	BYTE
WireBreakDiag		WireBreakDiag	%IB19	BYTE
RangeDiag		RangeDiag	%IB20	BYTE

Figure 61: Addressing by data type

4.7 Diagnostics

The following diagnostic methods are available:

- LED signaling
- Error messages when compiling the project
- I/O system XN300 Master Diagnostics possibilities
- Diagnostic shell commands

Module present / module not present

Runtime system started / not started

PLC LED signaling

If the program has an error condition, the PLC status display LED in the front will light up red and flash green, since the program will be stopped automatically. → Section "3.6 LED indicators", page 63.

	Status LED		Description
	red	green	
PLC	–	–	RuntimeSystem not started <ul style="list-style-type: none"> • No power on X6
	–	Flashes	Communication
	–	ON	PLC RuntimeSystem started
	ON	–	Error status of the RuntimeSystem <ul style="list-style-type: none"> • Flash Error • Checksum error • Could not start SSL connection Fix: Check the log file
	ON	ON	RuntimeSystem has started and is signaling an error condition.

1) Flashes: The flashing frequency can vary depending on the transfer rate on the bus.

A program error condition can be caused by the following:

- Watchdog: E.g., the interval time of a task > The watchdog time
- Unsuccessful data access: E.g., attempting to access a protected area

I/O system XN300 Master Diagnostics possibilities

For errors that occur in the system block (XC-303 locally expanded with modules with I/O system XN300), the status can be requested from the XN300 master for diagnostic purposes. To do so, follow the steps below:

- ▶ Open XSOFT-CODESYS-3 to access the device online.
- ▶ In the configuration tree, select the "Device (XC-303)" device and "XN300_Master".
- ▶ Double-click on "XN300_Master" and open the "XN300Master Parameters" tab.

4 PLC configuration

4.7 Diagnostics

- ▶ In an error scenario, the "Current value" column will contain an error number and a corresponding description. For instance, the following example has error number "47" and "The CoDeSys SDIAS configuration is not yet found on the PLC!" as the description.

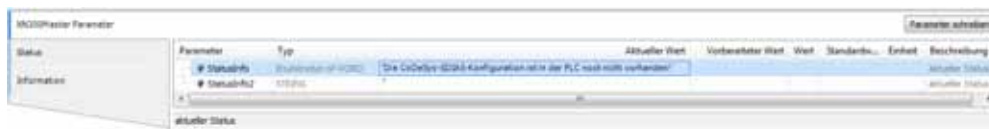
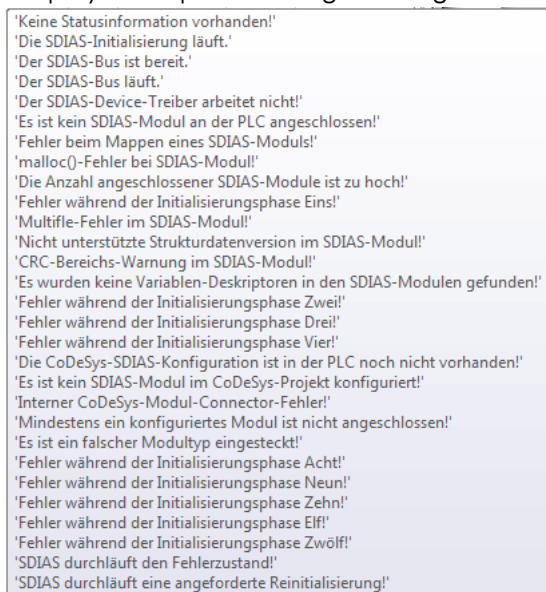

Figure 62: "XN300Master Parameters" tab with error message

Display example showing messages for the local XN300 system bus



For more information on diagnostics, please refer to the manual for the I/O system XN300, "XN300 slice modules" and "CANopen Gateway XN-312-GW-CAN"

Shell commands for diagnosing I/O system XN300 modules used

- ▶ In Explorer, double-click on the device (e.g., "Device (XC-303)") and select "PLC Shell" under the "Device" tab.
- ▶ Enter the "?" command into the command line.

4.8 Factory reset

4.8.1 Resetting the device to factory settings

If you want to reset the device to factory settings, you can use either the XControl web configuration server or the native configuration tool (on XV devices).

If you use the XControl web configuration server, follow the steps below:

- ▶ First log in to the device
- ▶ Go to the "Device" configuration page.
- ▶ Click on the "Factory reset" button. A confirmation prompt will appear.
- ▶ Confirm with OK. If you do not confirm the factory reset procedure, the device will not be reset to its factory settings. You will then have to wait 20 minutes.
- ▶ Restart the device.

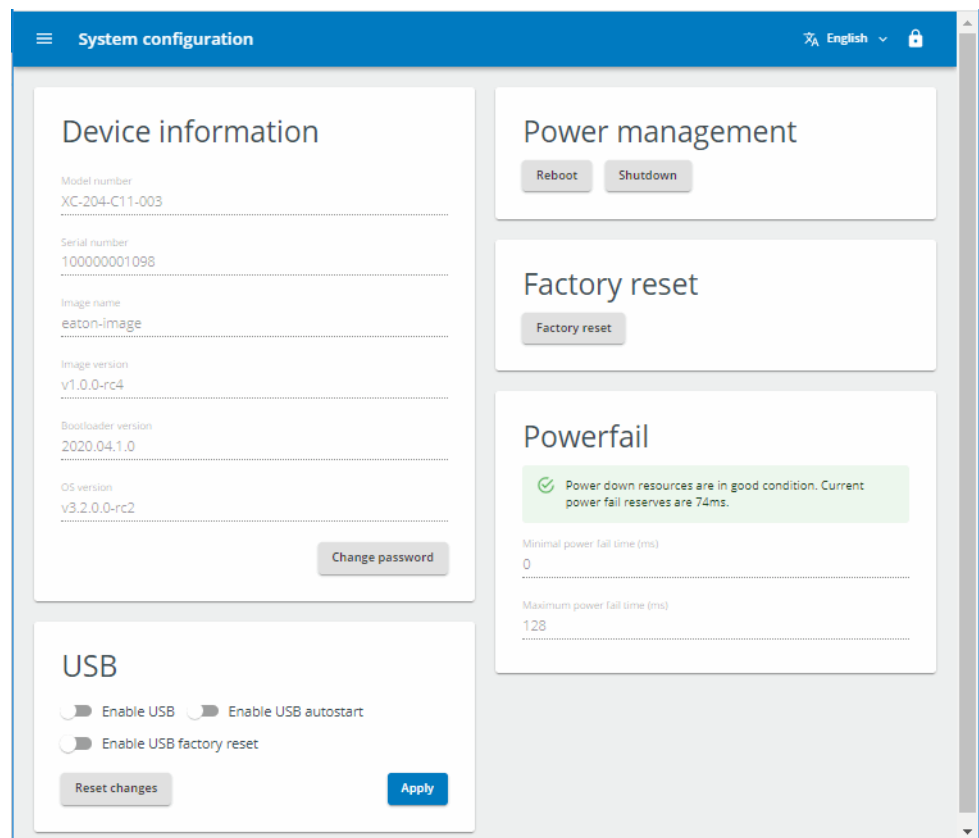

Figure 63: Web Config Tool start page

The device has now been reset to its factory settings.

4 PLC configuration

4.8 Factory reset

5 Connection set-up PC – Modular PLCs XControl: XC-104-..., XC-204-..., XC-303-...

The connection between PC and CPU (PLC) can be established via one of the Ethernet interfaces ETH0 to ETH2.

The Ethernet connection's transfer rate will be controlled with the autosensing function. Components in (detect) mode will automatically detect whether the connection is a 10 Mbit or 100 Mbit connection.

In this chapter you will get to know the settings to be made in the XSOFT-CODESYS-3 software. The following example shows how to create a new project.

5.1 Network search with automatic PLC detection

The PC will attempt to connect to the PLC and will indicate a successful connection with green circles.

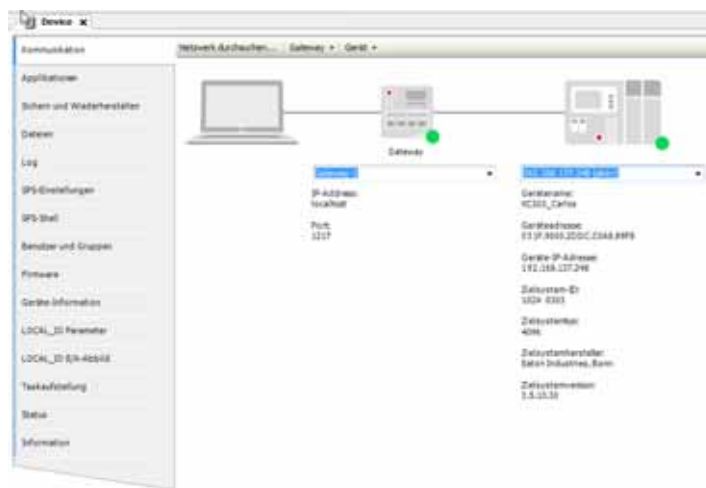

Figure 64: Successful connection between PC and XControl PLC

5.2 Creating a new project

- ▶ Start by making sure that you have connected the PC's Ethernet port or USB/Ethernet adapter to the device's Ethernet port with a cable.
- ▶ Make sure that the IP addresses for the PC and the device are in the same number range.
- ▶ Start the XSOFT-CODESYS-3.
- ▶ Click on "File", "New Project", "Standard Project" and enter a project name (e.g., "Test").
- ▶ In the next screen, select a device (e.g., "XC-303 (Eaton Automation)") and the programming language you want to use (e.g., "structured text" [ST]).
- ▶ Confirm the information being displayed by clicking on "OK."

The device will be added to the project. The default tree for the project will be generated as the corresponding configuration tree. The application will contain the library manager with all required libraries, and the "PLC_PRG" Main Task will have also been created already.

Establishing communications

- ▶ You can edit and rename the device name (e.g., "Device (XC-303)", the "Application" application, and the "PLC_PRG" main program if necessary.
- ▶ Double-click on the "Device (XC-303)" device and select the "Communication" tab.
- ▶ Click on the "Search network" button or enter the PLC's IP address.

All the devices that can be reached will be listed.

- ▶ Clicking on the "Flash" button will cause the selected device to output a temporary flashing pattern.



Use this function to clearly identify the PLC.



Figure 65: Adding a device with the corresponding IP address

5.3 Changing the IP address on the PLC

When changing IP addresses, make sure that the IP addresses for the PC and the Modular PLCs XControl: XC-104-..., XC-204-..., XC-303-... belong to the same network/subnet.

Example:

IP address **PC**:192.168.119.100

Subnet mask:255.255.255.0

XControl IP address:192.168.119.204

Subnet mask:255.255.255.0

There are three different ways to change the PLC's IP address:

1. PLC shell commands `getipconfig; setip... ..addr/...netmask/...gateway`
2. `setipconfig` and `getipconfig` functionality in the EA_Network library
3. `networkconfig.temp1` on MicroSD memory card or USB device
4. Web Config Tool for XC-104-... and XC-204-... modular PLCs → Section "Change the device's IP address", page 144.

PLC shell command

- ▶ Open the PLC browser – please refer to → Section "17.1 Using PLC shell commands", page 157.
- ▶ Enter `setipconfig <IP address>` into the command line
- ▶ Confirm with <Enter>.
- ▶ Restart the device after you have changed the IP address.

setipconfig function

Make sure that the EA_Network library has been added in the library manager.

Use the function in your program (in "PLC_PRG", for example).

- ▶ To do this, open the input assistance function with <F2>.

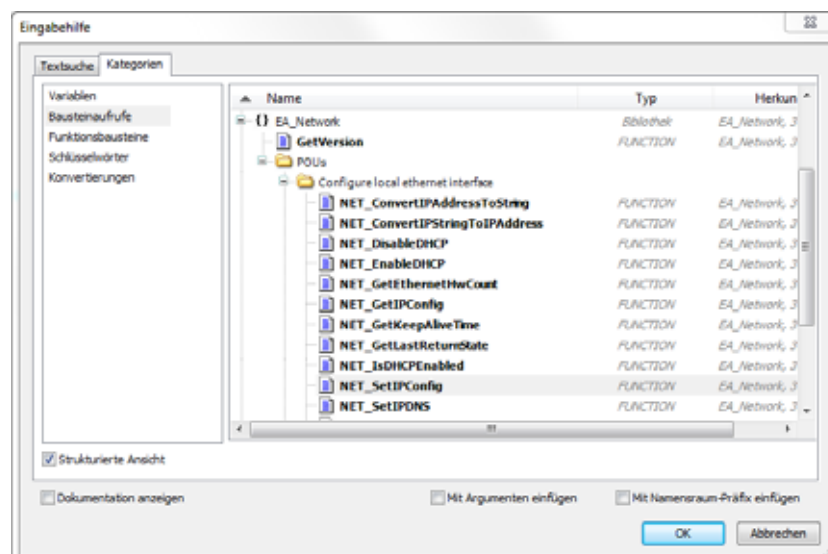

- ▶ Select "Function block call" under "Categories."

5 Connection set-up PC – Modular PLCs XControl: XC-104-..., XC-204-..., XC-303-...

5.3 Changing the IP address on the PLC

- ▶ Select "EA_Network", "POUs", "Configure local ethernet interface", "NET_SetIPConfig".
- ▶ Enter the port, the IP address, and the subnet mask as the corresponding parameters.

networkconfig

If you are unable to establish a connection to the device (because you do not know the IP address, for example), you can use the "networkconfig.temp1" file with a MicroSD memory card or a USB device to set a new IP address for the XControl's Ethernet interfaces.

Setting the IP address for Ethernet interface ETHx:

Prerequisites: The NW_UPDATE_FROM_USB or NW_UPDATE_FROM_SD tag must be set to "1".

In the case of XC-104-... and XC-204-... modular PLCs, the device's Ethernet interface must additionally be activated – please refer to → Section "14.4.3 USB interface activation", page 141.

- ▶ Save the "networkconfig.temp1" file in a directory on your PC. On the MFD-Titan, the file will be found in the "ome" directory
- ▶ Edit the file.
- ▶ Assign a valid IPv4 IP address and subnet mask
For example: ETH1_IP_ADDRESS=192.168.137.248 and
ETH1_SUBNET_MASK=255.255.255.0



If the properties for an Ethernet adapter change, all the parameters need to be completely entered into the file even if they match the corresponding default settings.

- ▶ Save the "networkconfig.temp1" file as a file named "networkconfig".
- ▶ Copy the file to the "XC303/update" directory on the MicroSD memory card/USB device.
- ▶ Insert the MicroSD memory card into the XControl.
- ▶ Reboot the XControl and then delete the file from the MicroSD memory card/USB device.

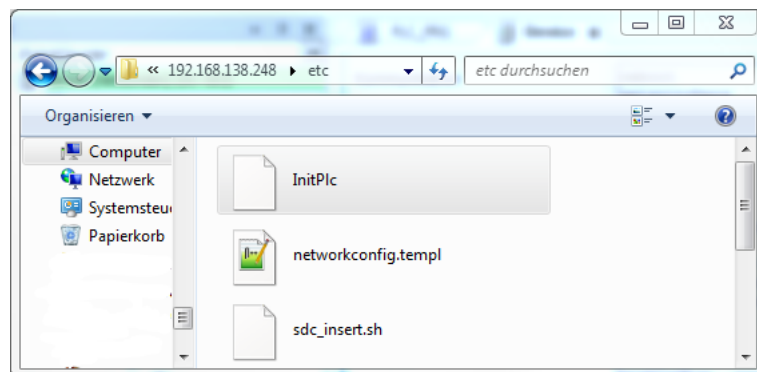

Figure 66: networkconfig.temp1 file on the XControl

6 In-/output configuration and parameterization

6.1 Configuring the device's local inputs/outputs

The I/Q1 to I/Q4 local inputs/outputs of the PLC are configured as inputs by default. If you want to change this configuration, follow the steps below:

- ▶ Select the device in the configuration tree and double-click to open the "Device" tab.
- ▶ Select "LOCAL_IO Parameter".
- ▶ Double-clicking on a cell in the "Value" column will show a drop-down menu that you can use to define the node as an input, output, or interrupt input.

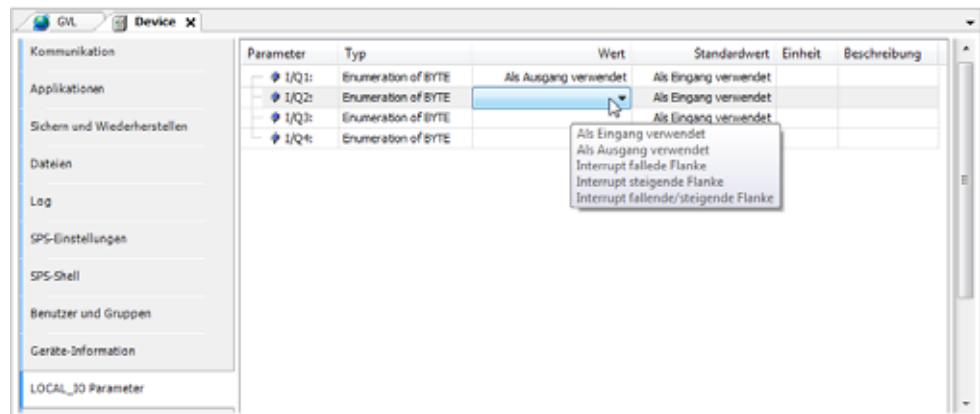

Figure 67: Configuration of the inputs/outputs

6 In-/output configuration and parameterization

6.2 Interrupt processing

6.2 Interrupt processing

When an interrupt occurs, the operating system executes the program organization unit (POU) linked to the interrupt source.



The execution of the interrupt POU is **not** time monitored. Programmed infinite loops will not be exited!

Local inputs I1 to I4 can be used as interrupt sources.

They can be configured with Device-> local _IOParameters.

Available settings:

- Int falling
- Int rising
- Int descending + rising

The POU called by the interrupt-event is always completely processed and cannot be interrupted by a new interrupt. A new interrupt is only carried out after the current interrupt has ended.

ATTENTION

All the outputs controlled (H signals) up to this point remain active and can't be switched off.

The interrupts are enabled in the RUN state of the CPU and inhibited in the STOP state. Interrupt sources that are not enabled in the configuration will not trigger an interrupt. If a POU is not assigned to an enabled interrupt source, the interrupt is recognized and executed but without running a POU.

Frequent occurrence of an interrupt during program execution can cause the programmed task time to time-out and result in a RESET being initiated by the Watchdog.

Interrupts can be inhibited and re-enabled from the program. The functions `DisableInterrupt` and `EnableInterrupt` are provided for this purpose. A call parameter in the XSOFT-CODESYS-3 software determines if an individual interrupt or all interrupts are enabled or inhibited. Enabling of an inhibited interrupt must be performed with the same parameter used to inhibit it.

Both the `DisableInterrupt` and `EnableInterrupt` functions are components of the `EA_XC303Events.lib` library. This library must – if not already done so – be integrated into the library manager of the XSOFT-CODESYS-3, see → Section “16.2 Installing additional system libraries”, page 153.

DisableInterrupt

With this function, you disable (deactivate) a parameterized physical interrupt by accessing it from the user program.

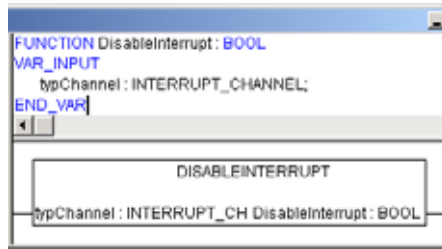

Figure 68: "DisableInterrupt" function

EnableInterrupt

With this function, the physical interrupt which was deactivated beforehand can now be re-enabled as an active interrupt.

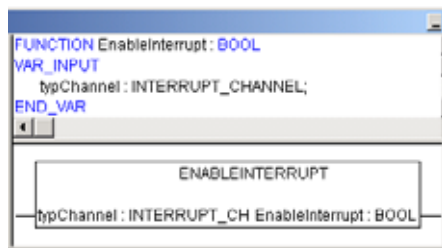

Figure 69: "EnableInterrupt" function

Parameterization

The parameterization and prioritization of the interrupt occurs in the "PLC and Task Configuration" of the CODESYS (activate the "Resources" tab and call up the "Task configuration → system events" folder). Each interrupt can be assigned with a POU here.

Example of interrupt processing

A "Basic" task contains a POU "PLC_PRG". A further POU "Fastprog" should be processed if an L → H rising edge on the input I0.4 generates an interrupt.

- ▶ Create the POUs „FAST_PRG“ as shown in Figure 70.

6 In-/output configuration and parameterization

6.2 Interrupt processing

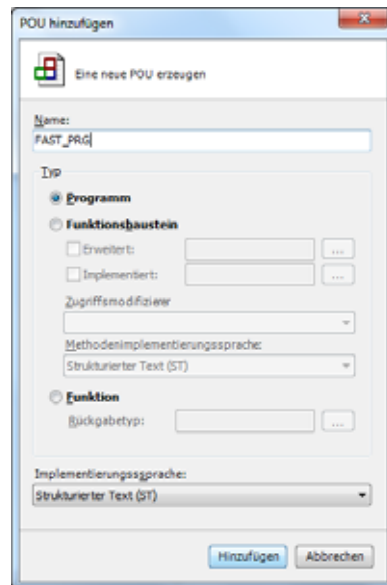

Figure 70: PLC and Task configuration

- Changeover to the PLC configuration and assign input I0.4 (L → H edge) e.g. the interrupt source "Interrupt - rising edge" from the drop-down menu.

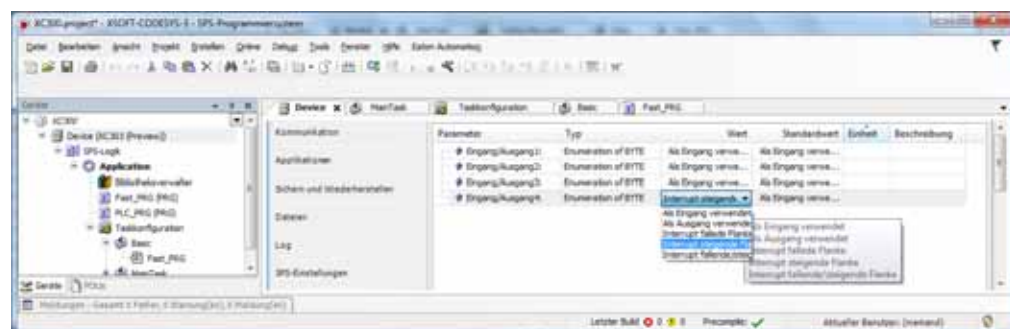

Figure 71: allocation I0.5 → interrupt source

- Change over to the Task configuration and open the "System events" folder.

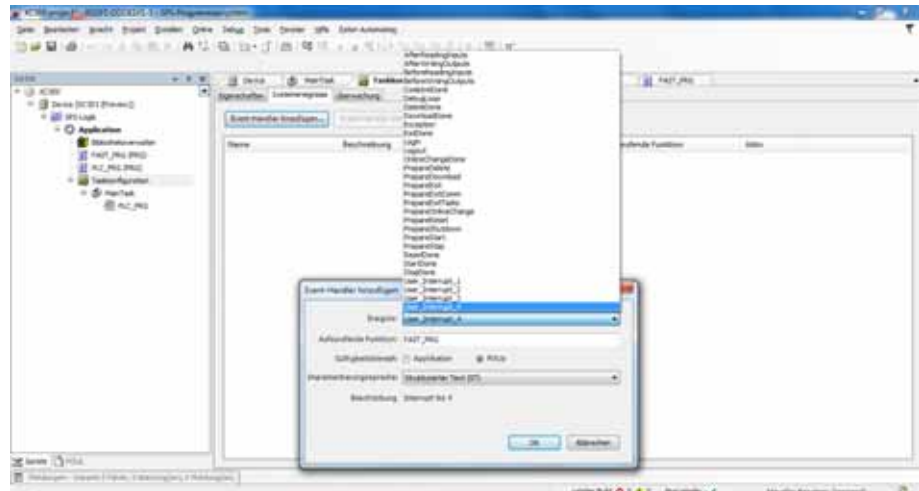

Figure 72: System events

- ▶ Select "UserInterrupt 4".
- ▶ Select the "Called POU" column area.
- ▶ Select the "FAST_PRG" POU and confirm with "OK".
- ▶ Save the project. You can now test it.

The "FAST_PRG" program will be called with every rising edge at input 4.

6 In-/output configuration and parameterization

6.2 Interrupt processing

7 Defining system parameters

7.1 Overview

System parameters independent of the project can be set by you and saved on the memory card. These parameters will be grouped together on the card in the following files:

- `networkconfig.template` -> `networkconfig`
- `deleteboardapplication.template` -> `deleteboardapplication`

You can also use the memory card in other PLCs. When starting, the PLC will automatically apply the parameters defined in the files.

- SD/USB in XC-303/update folder
- `deleteboardapplication.template` -> `deleteboardapplication`

Templates on the PLC in the "home" folder.

7.2 InitPLC file with default parameters

The InitPLC file is always created with all PLC-specific entries.

All parameters are predefined already. The following screenshot shows the parameters with the corresponding default values, which you can change as necessary.

```
#-----
#   Communication Protocols
#-----

# Set to 1 to enable FTP Server. (Unsecure connection)
ENABLE_FTP=0
# Set to 1 to enable telnet Server. (Unsecure connection)
ENABLE_TELNET=0
# Set to 1 to enable SSH Server . (Secure connection, needs a valid
certificate.)
# SSH can be enabled/disabled using the XSoft-Codesys "PLC Shell" command
ssh_access.
ENABLE_SSH=1
# Set to 1 to enable SFTP Server. (Secure connection, needs a valid
certificate.)
# SSH must be activated to use SFTP!
ENABLE_SFTP=1
# Set to 0 to prevent ping response send by the plc.
ENABLE_PING_RESPONSE=1
```

7 Defining system parameters

7.2 InitPLC file with default parameters

```
#-----  
#   Bootproject behaviour  
#-----  
# A bootproject can be copied from a distant location to "/home/Plc_Prg"  
and started as bootproject.  
# the check for bootprojects will terminate at the first location a boot-  
project is found.  
# Test order: SD-Card, USB-Stick, User defined path.  
# Overwrite existing bootproject if it differs to the one found on the  
external location.  
OVERWRITE_BP=1  
# Set to 1 to copy a bootproject from "/home/disk_sd/XC303/Project" to  
local storage "./Plc_Prg"  
COPY_BOOTPROJECT_FROM_SD=1  
# Set to 1 to copy a bootproject from "/home/disk_usb/XC303/Project" to  
local storage "./Plc_Prg"  
COPY_BOOTPROJECT_FROM_USB=1  
# Set to 1 to copy a bootproject from a defined path  
(USER_DEFINED_BP_PATH) to local storage "./Plc_Prg"  
COPY_BOOTPROJECT_FROM_USER_DEFINED_BP_PATH=0  
USER_DEFINED_BP_PATH=  
# A bootproject located on the plc will be deleted if a file named  
"deletebootapplication" is found on an  
# USB or SD folder /XC303/update  
ALLOW_BOOTPROJECT_DELETION=1  
#-----  
#   Firmware update behaviour  
#-----  
# Update firmware only if the version of the image to be updated is higher  
than the existing firmware.  
FW_ONLY_NEWER_VERSION=0  
  
# Overwrite existing firmware in any case. Flag will be removed on first  
firmware-update  
FW_FORCED_OVERWRITE=0  
# Take firmware from SD card  "/home/disk_sd/XC303/Firmware"  
FW_INSTALL_FROM_SD=1  
# Take firmware from USB-storage  "/home/disk_usb/XC303/Firmware"  
FW_INSTALL_FROM_USB=1  
# Set to 1 to install a firmware XSoft-Codesys Updater"  
FW_INSTALL_FROM_XSOFTCODESYS=1  
# Set to 1 to install a firmware from a defined path  
(USER_DEFINED_FW_PATH)"  
FW_INSTALL_FROM_USER_DEFINED_FW_PATH=0  
USER_DEFINED_FW_PATH=  
#-----  
#   Reset network settings  
#-----  
# You should take care to move the networkconf file, once the reset values  
have been applied.  
# A networkconf template file can be found on /home/etc/network-  
config.template  
# Reset network configuration by booting the plc with a config File  
located on /home/disk_usb/XC303/update/networkconfig  
NW_UPDATE_FROM_USB=1  
# Reset network configuration by booting the plc with a config File  
located on /home/disk_sd/XC303/update/networkconfig  
NW_UPDATE_FROM_SD=1
```

7.3 Switch-on of the control with inserted memory card with InitPLC file

```

#-----
#   Start behaviour
#-----
# Delay the start of the runtime system for a given number of seconds.
# (This start delay may be needed to detect USB devices.)
PLC_START_DELAY_SEC=4
# Set to 1 to skip the plc-runtime start
DISABLE_PLC_START=0
# Restrict the processor core usage of the plc-runtime. Valid entries:
# "CORE_0", "CORE_1", "BOTH"
PLC_CORE_USAGE=CORE_1
# Set to 1 to constantly check rts-state.
PLC_SUPERVISE_RTS=1
# Set to 1 to Reboot the PLC if the runtime system terminates unexpectedly.
PLC_REBOOT_ON_RTS_TERMINATION=1
#-----
#   Log Files
#-----
# Defined path used to save log files. (Default path "/var/log" is volatile,
# log files located there are lost after a power cycle.)
LOGFILE_DIR=/var/log
# Name of log file containing messages during the start up process.
LOGFILE_STARTUP=XC303Log.txt
# Name of log file containing messages from the plc runtime system.
LOGFILE_RTS=codesyscontrol.log
#-----
#   Map network drive
#-----
# A network drive may be mapped into the view of the plc filesystem using
# nfs (Linux/Unix) or cifs (Windows).
# Using nfs (network file system). A path "/home/disk_nfs" will be
# created.
MAP_NFS_FOLDER=0
NFS_SOURCE_PATH=
# Using cifs (common internet file system). A path "/home/disk_cifs" will
# be created
MAP_CIFS_FOLDER=0
CIFS_SOURCE_PATH=
CIFS_USER_NAME=
CIFS_DOMAIN_NAME=
CIFS_PASSWORD=

```

7.3 Switch-on of the control with inserted memory card with InitPLC file

These system parameters are also active after a new program is loaded.

The start process will update the following:

- Firmware
- Boot project (user program)
- Network configuration

See also → Section “3.3 Startup behavior XC-104-..., XC-204-..., XControl”, page 56.

For all checks in general after the Modular PLCs XControl: XC-104-..., XC-204-..., XC-303-... start, the MicroSD slot will be checked first and then the USB Host!

7 Defining system parameters

7.4 networkconfig file

If there is a boot application on the MicroSD memory card or USB device and it is a newer version than the one stored in the MFD-Titan, the boot application in the PLC will be updated.

The retentive data will then be loaded.

If the PLC is in the middle of a warm/cold start and the "STOP" DIP switch is in the "OFF" position, the user program will be started.

The positions of the DIP switch are described in detail in → Section "3.4.1 DIP switch S1", page 58.

7.4 networkconfig file

You can change the device settings for the network in this file. Blank entries will be ignored.

To modify the parameters, follow the steps below:

Prerequisite: The NW_UPDATE_FROM_USB or NW_UPDATE_FROM_SD tag must be set to "1".

- ▶ Open the "networkconfig" file and edit the parameters you want.
- ▶ Save the edited file with the name "networkconfig" in the ".XC303/update" directory on the MicroSD memory card or USB device.
- ▶ Insert the MicroSD memory card into the slot or plug in the USB device.
- ▶ Start the Modular PLCs XControl: XC-104-..., XC-204-..., XC-303-....

You can find templates for the "networkconfig" and "deleteBootproject" files on the Eaton Download Center.

Table 13 Predefined default parameters in the networkconfig file

```
#-----  
# ETH 0  
#-----  
ETHO_DISABLE=  
# 1 will disable the interface.  
# Default value:0  
  
ETHO_ENABLE_DHCP=  
# 1 will enable dhcp client on the interface.  
# Default value:0  
  
ETHO_IP_ADDRESS=  
# Should contain a valid IP-v4 ip-address,  
# if DHCP is enabled this field must be left blank.  
# Default value:192.168.119.248  
  
ETHO_SUBNET_MASK=  
# Should contain a valid IP-v4 subnet mask  
# Default value:255.255.255.0  
  
ETHO_BROADCAST=  
# Should contain a valid broadcast address  
# Default value:255.255.255.255  
  
ETHO_DEFAULT_GATEWAY=  
# Should contain a valid IP-v4 ip-address of the default gateway.  
# Default value: no default value.
```

```
#-----  
# ETH 1  
#-----  
ETH1_DISABLE=  
# 1 will disable the interface.  
# Default value:0  
  
ETH1_ENABLE_DHCP=  
# 1 will enable dhcp client on the interface.  
# Default value:0  
  
ETH1_IP_ADDRESS=  
# Should contain a valid IP-v4 ip-address,  
# if DHCP is enabled this field must be left blank.  
# Default value:192.168.137.248  
  
ETH1_SUBNET_MASK=  
# Should contain a valid IP-v4 subnet mask  
# Default value:255.255.255.0  
  
ETH1_BROADCAST=  
# Should contain a valid broadcast address  
# Default value:255.255.255.255  
  
ETH1_DEFAULT_GATEWAY=  
# Should contain a valid IP-v4 ip-address of the default gateway.  
# Default value: no default value.  
#-----  
# ETH 2  
#-----  
ETH2_DISABLE=0  
# 1 will disable the interface.  
# Default value:0  
  
ETH2_ENABLE_DHCP=  
# 1 will enable dhcp client on the interface.  
# Default value:0  
  
ETH2_IP_ADDRESS=  
# Should contain a valid IP-v4 ip-address,  
# if DHCP is enabled this field must be left blank.  
# Default value:192.168.138.248  
  
ETH2_SUBNET_MASK=  
# Should contain a valid IP-v4 subnet mask  
# Default value:255.255.255.0  
  
ETH2_BROADCAST=  
# Should contain a valid broadcast address  
# Default value:255.255.255.255  
  
ETH2_DEFAULT_GATEWAY=  
# Should contain a valid IP-v4 ip-address of the default gateway.  
# Default value: no default value.
```

7 Defining system parameters

7.4 networkconfig file

8 Expansion

8.1 Local expansion

The XControl PLC can be expanded locally with up to 32 XN300 slice modules. To do this, the PLC and the XN300 slice modules need to be joined together and mounted on a mounting rail (DIN-rail) as a block. The I/O system XN300 has a large range of XN300 slice modules available that offer special functionalities in addition to digital and analog inputs and outputs, with two examples being a weigh module and a motor driver module.



For the latest information on the I/O system XN300, please visit our product pages:

www.eaton.eu/xn300

and use the Eaton Online Catalog for information on the available range of products:

<http://www.eaton.eu/ecat>

Enter "XN300" into the search box and the catalog will take you directly to the corresponding product group.

The "XN300 slice modules" manual describes all modules.

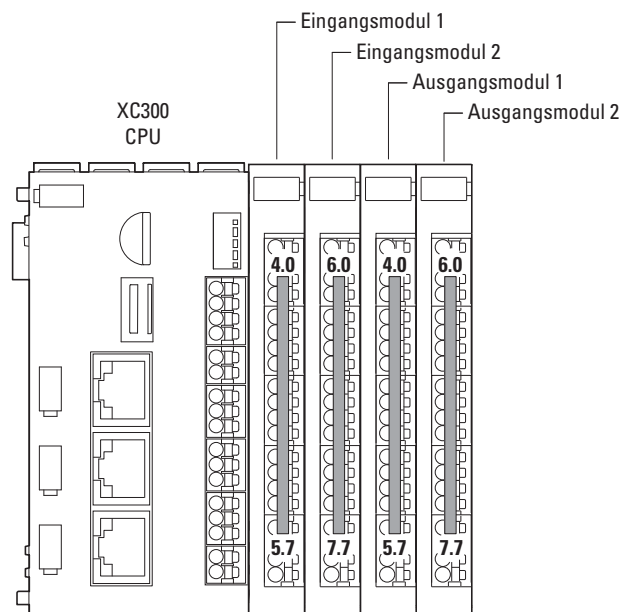

Figure 73: XControl central expansion XN300 slice modules

8 Expansion

8.1 Local expansion

8.1.1 Configuring the inputs/outputs for local expansions

If you have expanded the XControl PLC with XN300 slice modules and assembled them into a system block mounted on the DIN-rail, you can set up the corresponding configuration in XSOFT-CODESYS-3 as follows:

- ▶ Make sure that all XN300 slice modules are connected and powered.
- ▶ Open the XSOFT-CODESYS-3 project.
- ▶ In the device tree, select the "Device (XC-303)" device.
- ▶ Select the "Add device..." option in the context menu.
- ▶ Select the "XN300-Master" under "Miscellaneous" in the "Add device" dialog box.
- ▶ Confirm by clicking on the "Add Device" button.

The XN300_Master will appear in the device tree.

- ▶ Select the "XN300-Master" in the device tree.
- ▶ In the "Add device" dialog box, under "Miscellaneous," select the XN300 slice modules that you used to make a system block with the XControl. Select the XN300 slice modules in the same order that they are physically connected to the XControl.

The device tree will now show all the devices.

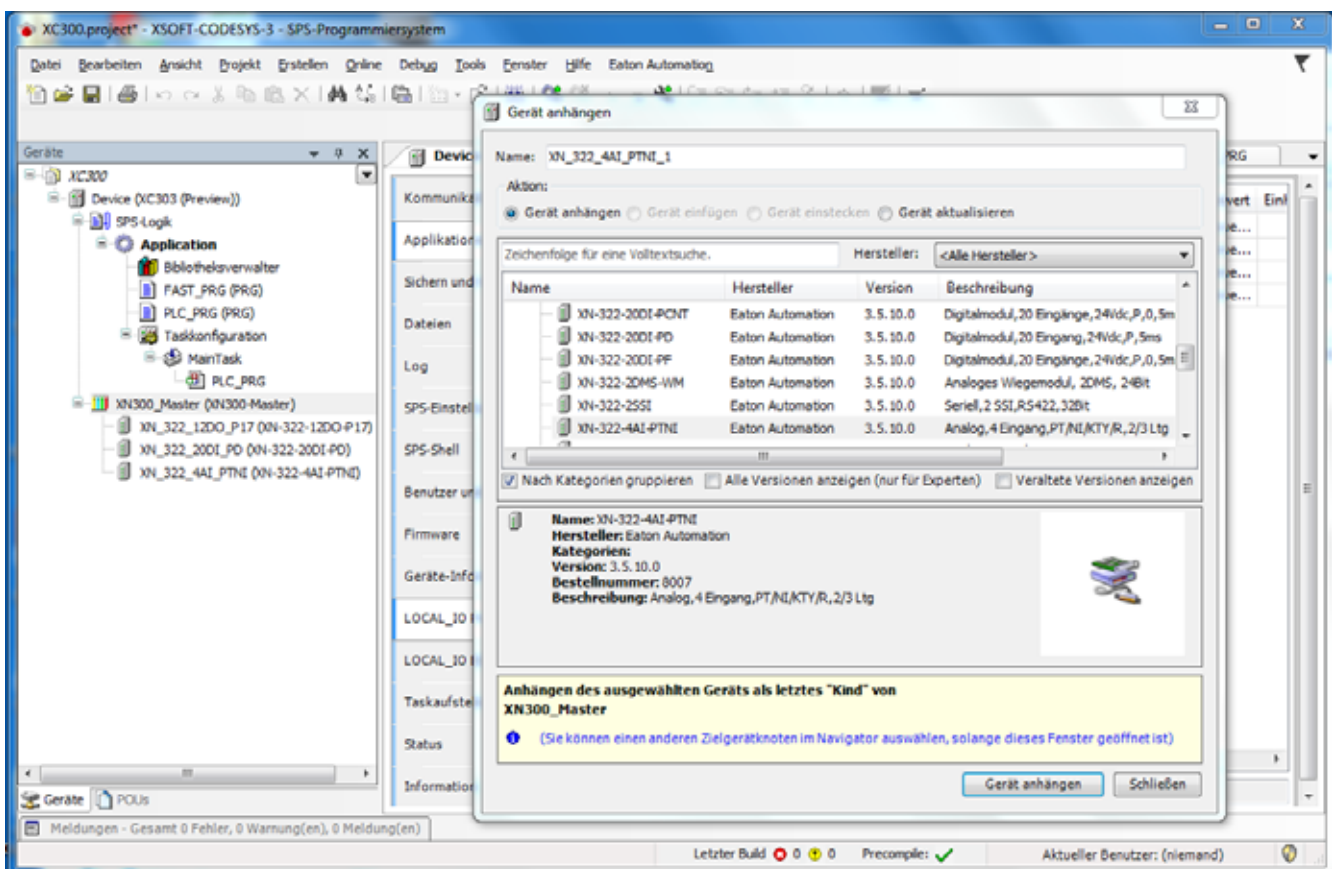

Figure 74: Device tree with XN300 slice modules

8 Expansion

8.1 Local expansion

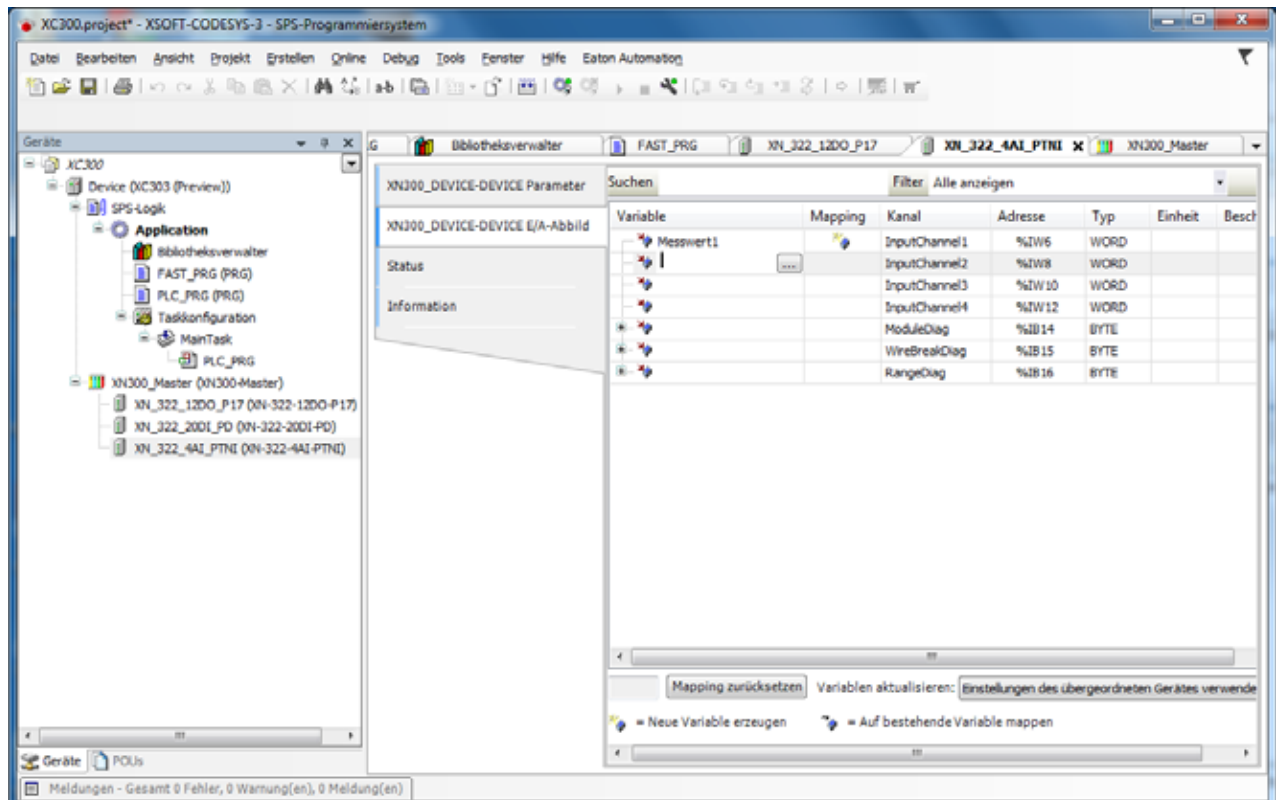

Figure 75: Declaring values

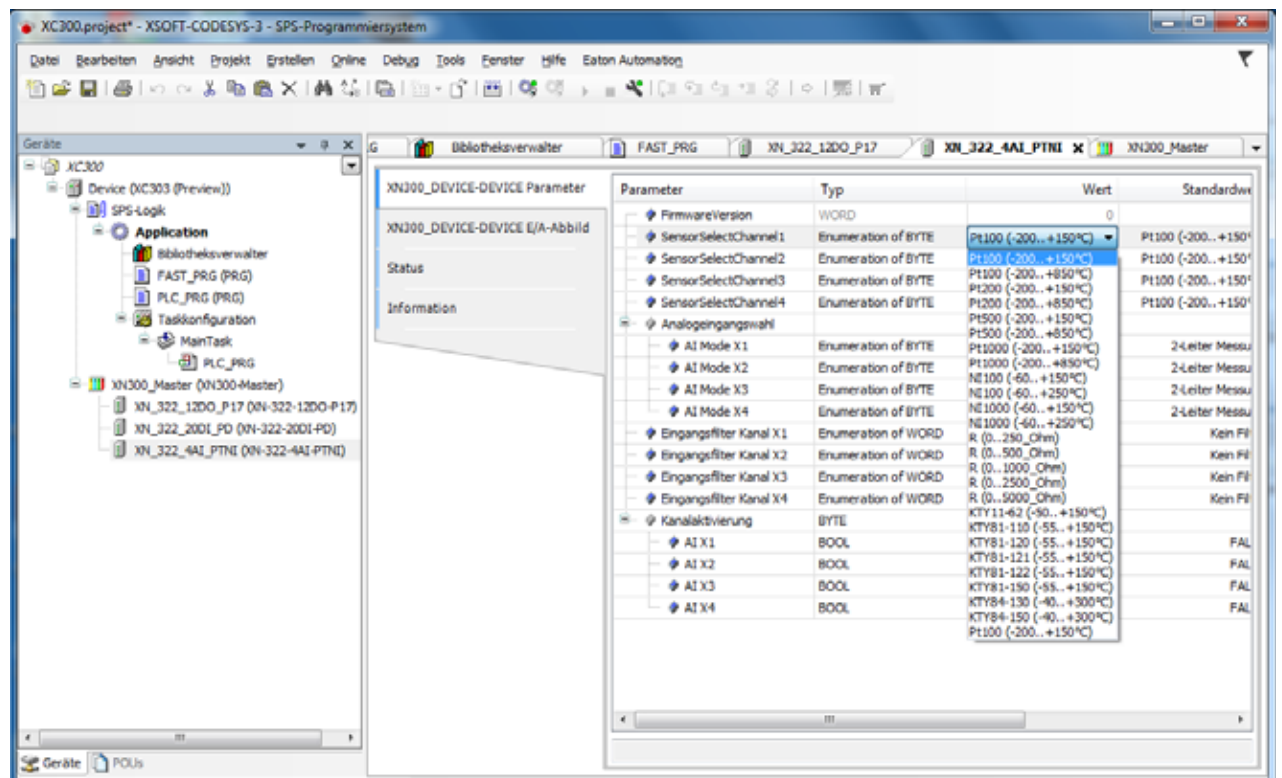

Figure 76: Define XN300 slice modules parameters

8 Expansion

8.2 Remote expansion

8.2 Remote expansion

→ Section “Modular PLCs XControl: XC-104-..., XC-204-..., XC-303-... support distributed expansion with the use of fieldbus interfaces. The following communication protocols are supported by the corresponding interfaces as follows:”, page 12

The following sections describe the individual fieldbus interfaces.

9 CAN

The components in the XN300 I/O system can be networked into a CAN node with the XControl: XC-204-..., XC-303-... modular PLCs with the Eaton CAN-Gateway XN-312-GW-CAN.

Each CAN node makes it possible to add expansions with the I/O system XN300 by adding up to 32 XN300 slice modules.

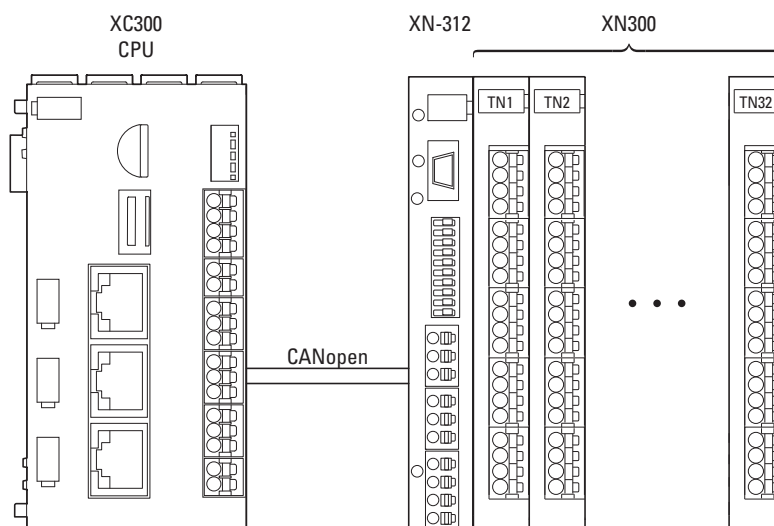

Figure 77: CAN node as a distributed expansion for the Modular PLCs XControl: XC-104-..., XC-204-..., XC-303-...

To do this, you will need to mount the system block consisting of a gateway and XN300 slice modules on a DIN-rail. The system block and the PLC can be mounted separately from each other. The XN300 system has a large range of XN300 slice modules available that offer special functionalities in addition to digital and analog inputs and outputs, with two examples being a weigh module and a motor driver module. For an overview of the XN300 slice modules, please refer to the "XN300 slice modules" manual.

The distance between the modular PLCs and an XN300 gateway can be up to 1000 m. The actual value depends on the baud rate used – please refer to → Section "Table 6 Max. cable lengths CAN", page 28.

9 CAN

9.1 Configuring and commissioning CANopen

9.1 Configuring and commissioning CANopen

Modular PLCs XControl: XC-104-..., XC-204-..., XC-303-... can communicate both through CAN and through CANopen. Communication through CANopen is described below.

Any CAN gateway can be connected to the CAN master by using the appropriate EDS file.

Following is an example showing how to connect an XN-312-GW-CAN CANopen gateway, including XN300 slice modules, to the CANopen master.

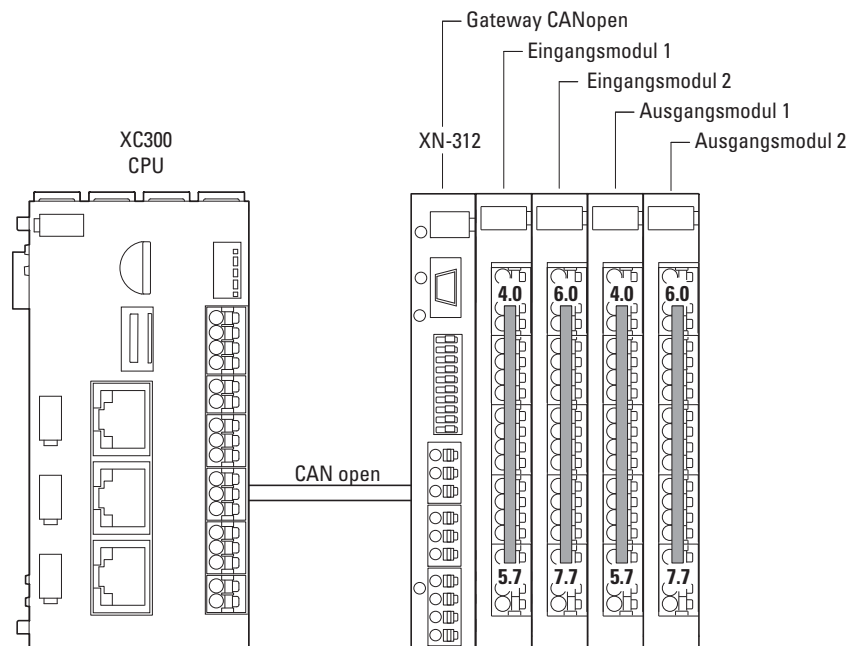

If you are putting the field bus into operation for the first time, you will first have to set up the PLC programming environment.

Initial commissioning

The following steps need to be carried out in general:

- ▶ Connect the Modular PLCs XControl: XC-104-..., XC-204-..., XC-303-... to the programming PC
- ▶ Connect the MFD-Titan to the CAN-Gateway XN-312-GW-CAN with a CAN bus cable.
- ▶ Set the DIP switches for CAN
 - Section "Activating the bus termination resistors", page 27.
- ▶ Set the node ID and the baud rate
- ▶ Save the configuration for the I/O system XN300 connected to the CAN-Gateway XN-312-GW-CAN in the "config check" on the gateway.
- ▶ Open your project in XSOFT-CODESYS-3 or create a new one
 - Section "5.2 Creating a new project", page 90.

9.1.1 Adding the CAN manager

- ▶ In the device tree, select the "Device (XC-303)" device.
- ▶ Right-click on it to open the context menu and select the <Add device...> option.

The "Add device" dialog box will appear. You can leave the dialog box open.

- ▶ Select the "CANbus" under "Field buses" in the "Add device" dialog box.
- ▶ Confirm by clicking on the "Add Device" button.

The CANbus will appear in the configuration tree.

- ▶ Select "CANbus" in the configuration tree.
- ▶ Select the baud rate.
- ▶ Select the "CANopen Manager" under "Field buses" in the "Add device" dialog box.

The CANopen Manager will appear in the configuration tree. EDS files for Eaton field bus modules will be installed automatically.

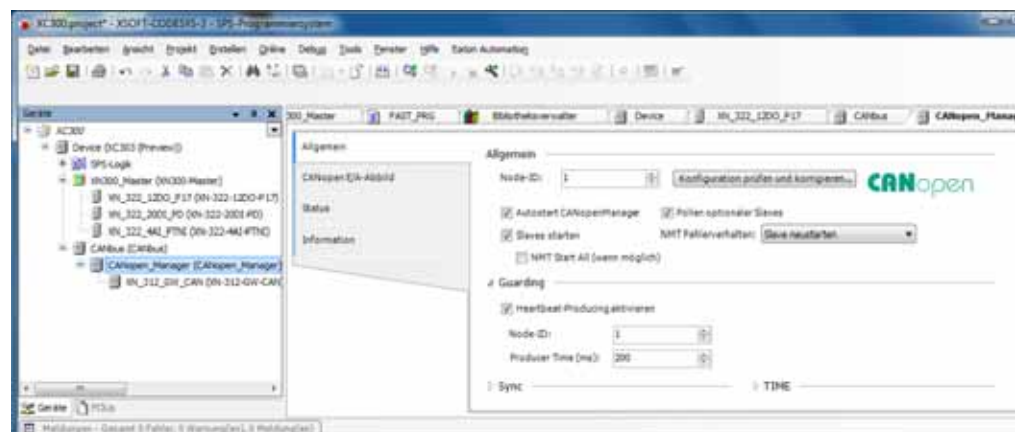

Figure 78: CANopen parameters for CANopen manager

9 CAN

9.1 Configuring and commissioning CANopen

9.1.2 Setting the baud rate via CANbus

- ▶ In the "Devices" configuration structure, double-click on <CANbus (CANbus)>.
- ▶ Open the "CANbus" tab and select the baud rate you want, e.g., <125000>.

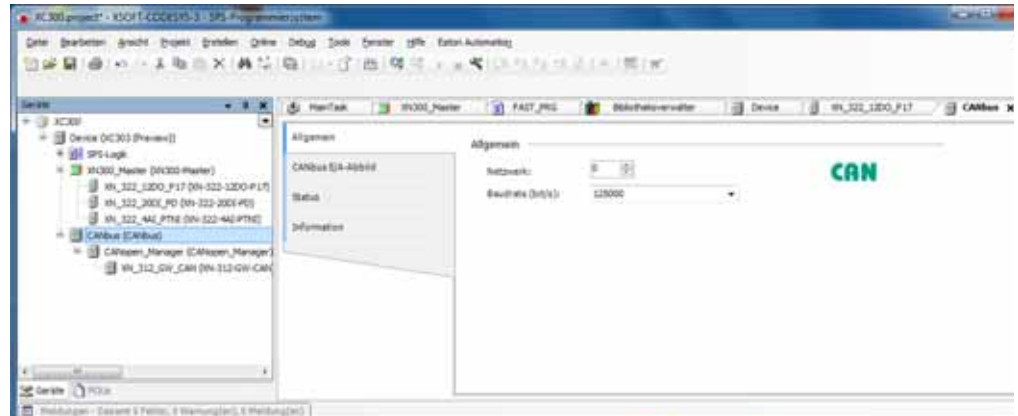

Figure 79: CANopen manager baud rate



For more detailed information, please refer to the online help for XSOFT-CODESYS-3, which can be opened by pressing the <F1> function key.

- ▶ The EDS files for the field bus modules from other manufacturers must be additionally installed in XSOFT-CODESYS-3 – please refer to → Section "9.1.5.2 Installing the EDS file", page 115.

9.1.3 Incorporating the CAN-Gateway XN-312-GW-CAN

- ▶ To add the CANopen gateway to your configuration, right-click on "CANopen manager (CANopen manager)."
- ▶ Click on the <Add device...> option.

The list will show all the devices that can be configured:

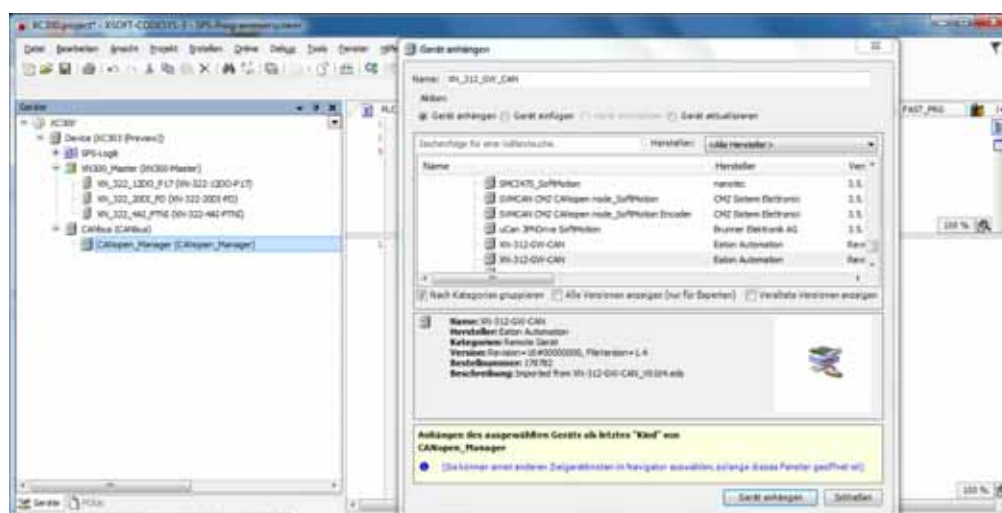

Figure 80: Adding a CANopen device

- ▶ Select the corresponding CAN-Gateway XN-312-GW-CAN.
- ▶ Click on the <Add device> button.

The selected CAN-Gateway XN-312-GW-CAN will be added to the configuration tree.

- ▶ If the CAN devices you want are not found in the list, update the XSOFT-CODESYS-3 version you are using or load the appropriate EDS file → Section "9.1.5.2 Installing the EDS file", page 115.
- ▶ Check the settings for the parameters for XN_312_GW_CAN by double-clicking on "XN_312_GW_CAN (XN-312-GW-CAN)" in the configuration tree.
- ▶ Open the "XN_312_GW_CAN/General" tab and check the device's "Node ID."



For more information on all other gateway settings and on mapping, please refer to the manual for CAN-Gateway XN-312-GW-CAN.

9.1.4 Attach XN300 slice modules

- ▶ To configure the system block, right-click on the CANopen device, e.g., "XN_312_GW_CAN (XN-312-GW-CAN)" in the "Devices" configuration structure.
- ▶ Then click on the <Add device...> option.

The "Add device" dialog box will appear if it is not open already. The dialog box will show a list with all the XN300 slice modules that can be configured.

9 CAN

9.1 Configuring and commissioning CANopen

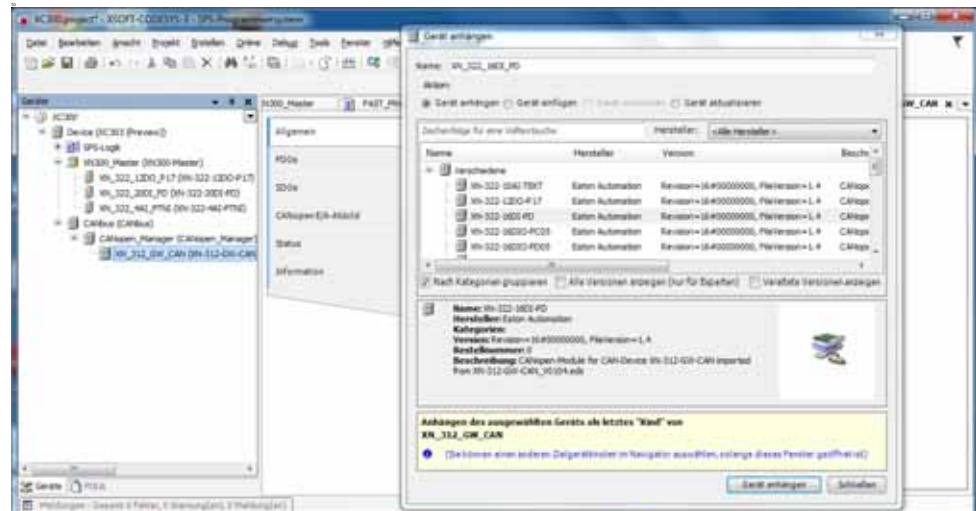

Figure 81: "Add device" dialog box for selecting CAN modules for the XN-312-GW-CAN

► Select the XN300 slice module you want and then select <Add device>. The XN300 slice module will be added to the "Devices" configuration structure.



You can change the order of the XN300 slice modules in the configuration structure by dragging and dropping them accordingly.

A maximum of 32 XN300 slice modules can be added to the CANopen device.

The device tree will now show all the devices.

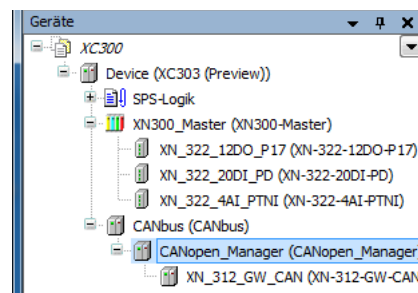

Figure 82: XControl with CANopen master, CAN-Gateway XN-312-GW-CAN, and four XN300 slice modules

If you are using analog modules, observe the following requirements:

- If you use the default mapping (index 0x6401/x) for analog modules, you will need to enable PDO-based transmission for these I/O slice modules by setting the value of object index 0x6423, subindex 0 to TRUE.
- Regulate the bus load on the CAN field bus
The following procedure is recommended in order to prevent the XN-312-GW-CAN gateway from generating a heavy load on the CAN field bus:

9.1 Configuring and commissioning CANopen

- Use internal module filters; please consult manual "XN-300 Slice Modules", MN050002-EN.
- If you use the default mapping (index 0x6401/x), you can configure a transmission filter for each individual payload object (SDO objects: AI_DELTA_VALUE, index 0x6426/x).
When this filter is configured, the gateway will update and transmit the corresponding value only if this value is different from the last transmitted value by more than the configured delta.

By setting an inhibit time or selecting a synchronous transmission type, TPDO properties can be configured in such a way as to avoid impermissible bus loads .

NOTICE

The short data refresh cycle times in the XN300 system can result in the CAN transmission path being subjected to high loads. Accordingly, it is recommended to limit the data being transmitted by using the various PDO properties available (e.g., inhibit time), especially in the case of analog input and technology modules featuring counters.

9.1.5 Description files for CANopen

The gateway XN-312-GW-CAN is integrated into the CANopen structure with the aid of a standardized EDS file (Electronic Data Sheet).

This EDS file lists all objects with the associated sub-indexes and the corresponding entries. The EDS file will be installed automatically in XSOFT-CODE-SYS-3 with the CANopen master.

9.1.5.1 Standard EDS files

Make sure that you are working with the latest version of the standard EDS files in your PLC programming environment. If modules are not listed, check whether there are available updates for the files in the Download Center → Page 8. To find it quickly, simply enter "XN300" or "EDS" as a search term.

9.1.5.2 Installing the EDS file

If you want to install an updated EDS file or an EDS file from another device manufacturer, follow the steps below:

- ▶ Select and download the latest version of the EDS file.
- ▶ Save and unzip the "*.zip" file to a project folder of your choice.
- ▶ Click on the <Tools | Device Repository...> menu option in XSOFT-CODESYS-3.
- ▶ Click on the <Install...> button.
- ▶ Use Explorer to select the EDS file you want.
- ▶ Confirm with click on <Open>.
- ▶ Click on "OK" on the "The device has been successfully installed" prompt.

9 CAN

9.1 Configuring and commissioning CANopen

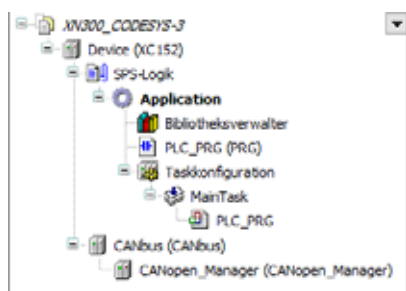

Figure 83: "Devices" pane with CAN manager in the configuration structure

- ▶ Double-click on CANopen_Manager (CANopen Manager).
- ▶ Check the settings under the "CANopen Manager" tab.

9.1.6 Adding CANopen communication libraries

By default, all the libraries required for CANopen communication will be automatically added after the CAN master is added and the project is compiled for the first time.

- 3S CANopenStack
- CAA CiA405
- CANbusDevice
- EA_CAN types (when using Eaton CAN devices)

9.1.7 LEDs on the device

The status display LEDs in the front signal the corresponding state.

→ Section "3.6 LED indicators", page 63

	Status LED		Description
	red	green	
CAN1	–	–	No bus activity
CAN2	–	Flashes	Bus activity OK (CAN), FLASHES with every frame
	ON	–	Bus error
	Flashes	Flashes	Warning

1) Flashes: The flashing frequency can vary depending on the transfer rate on the bus.

Every successfully transmitted/received CAN frame triggers the LED.

10 EtherCAT

Following is a description explaining how to configure Modular PLCs XControl: XC-104-..., XC-204-..., XC-303-... PLCs as an EtherCAT master in order to operate EtherCAT modules.

EU5C-SWD-ETHERCAT is used as an example of an EtherCAT module in this case. This EtherCAT gateway assumes the coordinator role for additional SmartWire-DT modules and their input and output functions.

In order for the EU5C-SWD-ETHERCAT gateway to be able to exchange data with the XControl PLC, both a target configuration and a project configuration must be stored on the gateway. For more information on how to set up these configurations and store them on the device, please refer to the "EU5C-SWD-ETHERCAT Gateway" manual, which is available for download in PDF format at:

www.hilscher.com

<Products | Gateways | SmartWire-DT-Gateways | EU5C-SWD-ETHERCAT | Downloads>.

Prerequisites

- A PC with an Ethernet adapter and XSOFT-CODESYS-3 PLC programming environment version 3.5.10 or higher installed.
- The PC's Ethernet adapter must be connected to the XControl PLC via Ethernet.
- XControl must be connected to the EU5C-SWD-ETHERCAT gateway.
- The Gateway is connected to the SmartWire-DT network.
- The gateway must have a valid SmartWire-DT configuration (the SWL LED on the device must show a solid green light).
- You must have access to the device description files for the EU5C-SWD-ETHERCAT gateway.

10.1 Incorporating the EtherCAT master

- ▶ In the device tree, select the "Device (XC-303)" device.
- ▶ Right-click on it to open the context menu and select the <Add device...> option.

The "Add device" dialog box will appear. You can leave the dialog box open.

- ▶ Select "EtherCAT | Master | EtherCAT Master" under "Field buses" in the "Add device" dialog box.
- ▶ Confirm by clicking on the "Add Device" button.

The EtherCAT master will appear in the configuration tree.

10 EtherCAT

10.2 Configuring the EtherCAT master



Figure 84: Device tree with EtherCAT master

10.2 Configuring the EtherCAT master

- ▶ Double-click on "EtherCAT_Master (EtherCAT Master)" in the PLC configuration device tree.
- ▶ Click on the <Search> button in the "General" tab.



Figure 85: EtherCAT master parameters

XSOFT-CODESYS-3 will show the MAC addresses and names for the Ethernet interfaces on the XControl PLC.



Figure 86: List of all XC-303-C32-002 PLC Ethernet interfaces found

- ▶ Select the Ethernet port to which you connected or will be connecting the EtherCAT gateway.
- ▶ Select the "Select network by name" setting in the "General" tab. This will make the PLC connect by name (e.g., "ETH2") independently of the MAC address.
- ▶ Enable the "Automatic slave restart" option so that communication with the modules will start automatically.

10.3 Searching for and incorporating EtherCAT modules

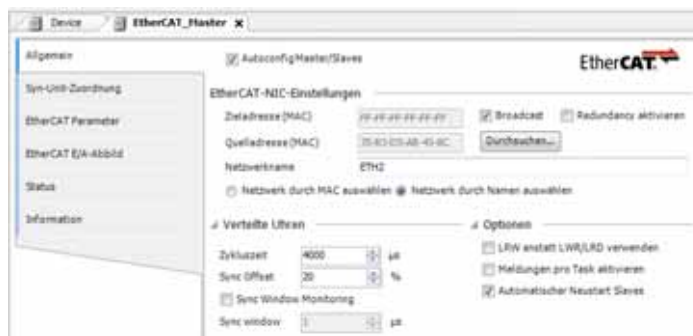

Figure 87: EtherCAT master settings

10.3 Searching for and incorporating EtherCAT modules

To connect the XControl PLC to an EtherCAT module such as a EU5C-SWD-ETHERCAT gateway, follow the steps below:

- ▶ Log in to the XControl PLC by using the <Online|Log in> command sequence in XSOFT-CODESYS-3.
- ▶ Right-click on "EtherCAT_Master (...)".
- ▶ Then select <Search for device...>.

The PLC programming software will run an automatic search for all devices connected to the XControl EtherCAT_Master. The search result list dialog box will show all the devices that were found.

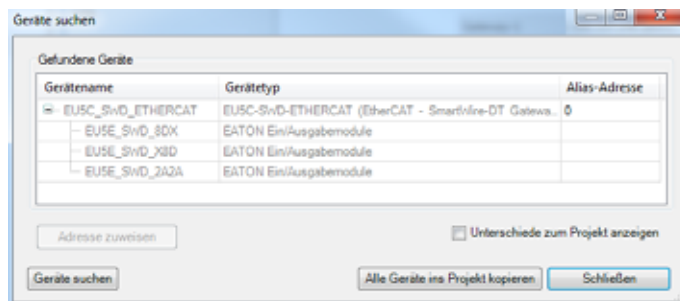

Figure 88: Search result list for the search for devices

- ▶ Click on the <Copy all devices to the project> button.

The devices will be shown in the PLC configuration's device tree. SmartWire-DT modules that are already connected to the EtherCAT gateway will also be shown in the device tree automatically (e.g., EU5E_SWD_8DX).

10 EtherCAT

10.4 Incorporating EtherCAT modules manually

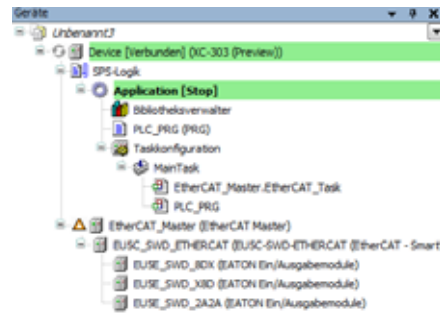

Figure 89: Device tree with EU5C-SWD-ETHERCAT gateway and SmartWire-DT modules

- ▶ If the EtherCAT devices you want are not found in the list, update the XSOFT-CODESYS-3 version you are using or load the appropriate XML file; → Section "10.6 Description files for EtherCAT", page 122.
 - ▶ Check the settings for the parameters for the EtherCAT gateway by double-clicking on "EU5C_SWD_ETHERCAT (...)" in the device tree.
- ➔ For more information on all other gateway settings and on mapping, please refer to the "EU5C-SWD-ETHERCAT Gateway" manual – please refer to → Page 117 and the XSOFT-CODESYS-3 Online Help.

10.4 Incorporating EtherCAT modules manually

As an alternative to the description in → Section "10.3 Searching for and incorporating EtherCAT modules", page 119, you can also add the EtherCAT modules to the XControl PLC manually. To do so, follow the steps below:

- ▶ Right-click on "EtherCAT_Master (...)" in the device tree.
- ▶ Click on the <Add device...> option.

The list will show all configurable devices:

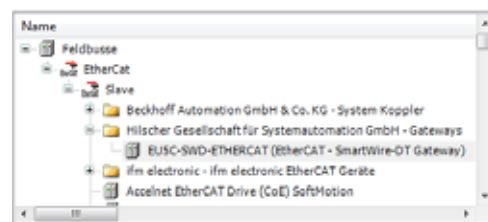

Figure 90: Adding an EtherCAT device

- ▶ Select the EtherCAT module you want, such as "EU5C-SWD-ETHERCAT" in the "Hilscher..." directory.
- ▶ Click on <Add device> in the "Add device" dialog box.

The EtherCAT module will be added to the device tree.

10.5 Add SWD module

- ▶ Right-click on "EU5C_SWD_ETHERCAT(...)" in the device tree and select <Add Device...>.
- ▶ In the "Add device" dialog box, select the SmartWire-DT module you want (e.g., "DIL-SWD-32-001-...").

The SmartWire-DT modules will be shown in the device tree.



For more information on all other gateway settings and on mapping, please refer to the "EU5C-SWD-ETHERCAT Gateway" manual – please refer to → Page 117 and the XSOFT-CODE-SYS-3 Online Help.

10 EtherCAT

10.6 Description files for EtherCAT

10.6 Description files for EtherCAT

Device description files in XML format are required in order to incorporate and configure EtherCAT modules in XSOFT-CODESYS-3. These files contain standardized descriptions of the EtherCAT modules and their parameters.

The device description files are installed in XSOFT-CODESYS-3 automatically with the EtherCAT master.

10.6.1 Standard XML files

Make sure that you are working with the latest version of the device description files in your PLC programming environment. If modules are not listed, check whether there are available updates for the files in the Download Center of the respective device manufacturer.

Example:

Say you want to incorporate and configure the EU5C-SWD-ETHERCAT gateway as an EtherCAT module. The gateway will coordinate communications with and between additional SmartWire-DT modules.

To do this, you would need multiple device description files for the gateway and the relevant SmartWire-DT modules in XSOFT-CODESYS-3. The latest versions of these device description files are available in a zipped file in the AUTOMATION Download Center at:

https://es-assets.eaton.com/AUTOMATION/DOWNLOAD/CONFIGURATIONFILES_CFG_GSD_EDS/SEVERAL_PARTS/ETHERCAT/EU5C-SWD/

You would save the CODESYS.zip file on your PC and unzip the file. The file contains several device description files, including, for example:

- Eaton_ETHERCAT_Modules.xml
- Dajo_EU5C_SWD-ETHERCAT_Modules.xml
- Hilscher_SWD_ETHERCAT_GW.xml
- Phoenix_ETHERCAT_Modules.xml
- Woehner_ETHERCAT_Modules.xml

You would then install the device description files in the PLC programming environment, e.g., XSOFT-CODESYS-3.

10.6.2 Installing the XML file

If you want to install an updated XML file or an XML file from another device manufacturer, follow the steps below:

- ▶ Select the latest version of the device description files and download them.
- ▶ Save and unzip the "*.zip" file to a project folder of your choice.
- ▶ Click on the <Tools | Device Repository...> menu option in XSOFT-COD-ESYS-3.
- ▶ Click on the <Install...> button.
- ▶ Use Explorer to select the XML file you want in the project folder.
- ▶ Confirm with click on <Open>.
- ▶ Confirm the "The device has been successfully installed" prompt by clicking on "OK".

- ▶ Double-click on "EtherCAT_Manager (EtherCAT Manager)".
- ▶ Check the settings under the "EtherCAT Manager" tab.

10.6.3 Adding EtherCAT communication libraries

By default, all the libraries required for EtherCAT communication will be automatically added after the EtherCAT master is added and the project is compiled for the first time.

- IODrvEtherCAT

10 EtherCAT

10.6 Description files for EtherCAT

11 Modbus

11.1 Configuring Modbus TCP

11.2 Adding an Ethernet adapter

XSOFT-CODESYS-3 offers two different Ethernet connection options. An Ethernet adapter can be used to define the corresponding protocol: EtherNet/IP or Modbus TCP.

- ▶ In the device tree, select the "Device (XC-303)" device.
- ▶ Right-click on it to open the context menu and select the <Add device...> option.

The "Add device" dialog box will appear. You can leave the dialog box open.

- ▶ Select "EtherNet/IP | Ethernet Adapter | Ethernet" under "Field buses" in the "Add device" dialog box.
- ▶ Confirm by clicking on the "Add Device" button.

The Ethernet master will appear in the configuration tree.

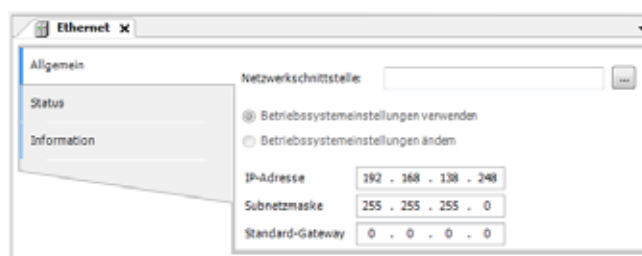

Figure 91: Ethernet master parameters

11.3 Adding a Modbus TCP master and device

- ▶ To add the Modbus TCP master to your configuration, right-click on "Ethernet (Ethernet)":
- ▶ Click on the <Add device...> option.

The list will show the available Ethernet devices or Ethernet-based protocols such as Modbus.

- ▶ Select "Modbus | Modbus TCP Master | Modbus TCP Master".
- ▶ Then click on the <Add device...> option
- ▶ Select "Modbus TCP Master" in the device tree.
- ▶ Right-click on it to open the context menu and select the <Add device...> option.
- ▶ Select "Modbus TCP Slave".
- ▶ Then click on the <Add device...> option

11 Modbus

11.3 Adding a Modbus TCP master and device

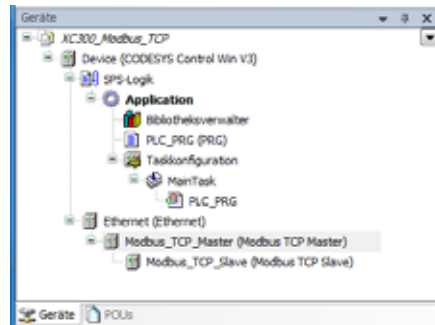

Figure 92: Adding a Modbus TCP slave

The TCP master does not need information specifying which Modbus_TCP_Slave is on the bus. It only needs the Modbus_TCP_Slave's IP address and register number.

- ▶ Select the "Modbus_TCP_Slave" slave connection in the configuration tree.
- ▶ Click on the <Add device> button.

The Modbus TCP device will be added to the configuration tree.

A maximum of 32 Modbus TCP masters can be added.

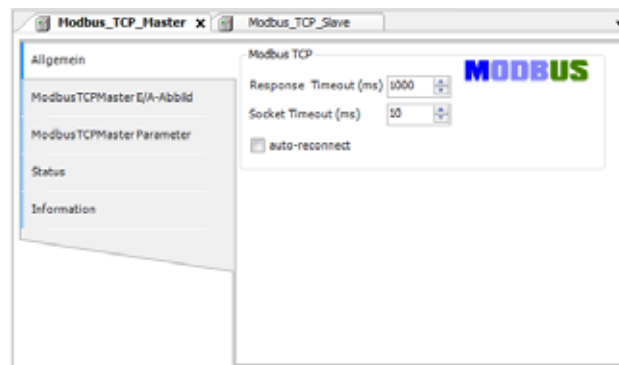

Figure 93: Modbus TCP master parameters

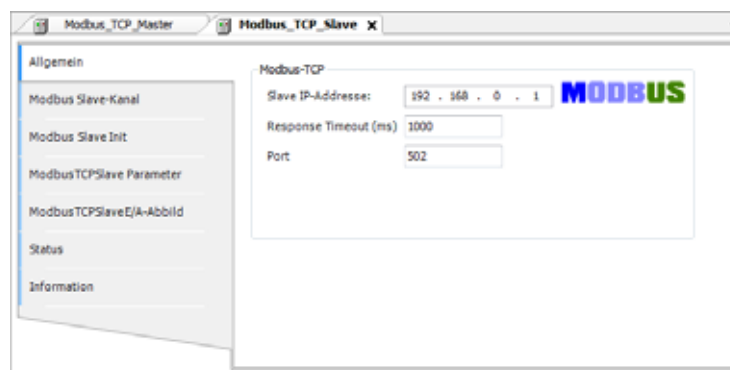

Figure 94: Modbus TCP slave parameters

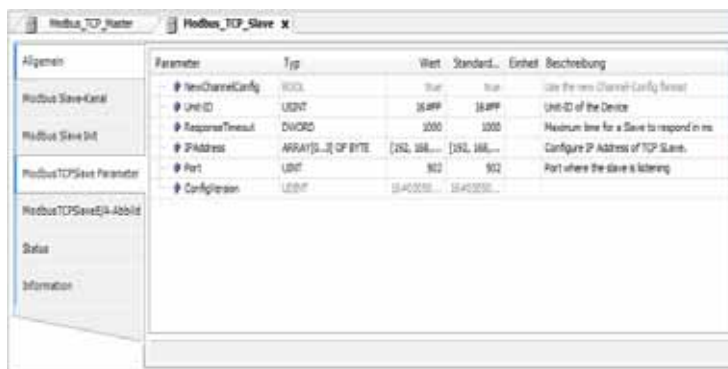

Figure 95: Modbus TCP slave parameters

11.4 Adding ModbusTCP communication libraries

By default, all the libraries required for ModbusTCP communication will be automatically added after the EtherCAT master is added and the project is compiled for the first time.

- IODrvModbusTCP
- IODrvEthernet

11 Modbus

11.5 Configuring Modbus RTU

11.5 Configuring Modbus RTU

11.6 Adding a Modbus master

- ▶ In the device tree, select the "Device (XC-303)" device.
- ▶ Right-click on it to open the context menu and select the <Add device...> option.

The "Add device" dialog box will appear. You can leave the dialog box open.

- ▶ Select "Modbus | Modbus Serial Port| Modbus COM Port" under "Field buses" in the "Add device" dialog box.
- ▶ Confirm by clicking on the "Add Device" button.

The Modbus_COM_Port will appear in the configuration tree.

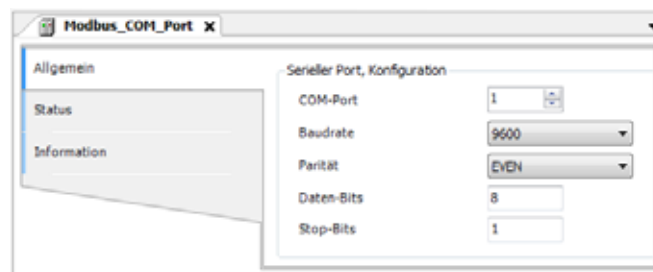

Figure 96: Modbus COM port parameters

11.7 Adding Modbus modules

- ▶ To add a Modbus module to your configuration, right-click on the "Modbus_COM_Port" node.
- ▶ Click on the <Add device...> option.

The list will show all the devices that can be configured:



Figure 97: Adding a Modbus device

- ▶ Select the corresponding Modbus device, e.g., "Modbus Serial Device."
- ▶ Click on the <Add device> button.

The selected Modbus device will be added to the configuration tree.

11.8 Adding libraries for Modbus RTU communication

By default, all the libraries required for Modbus communication will be automatically added after the EtherCAT master is added and the project is compiled for the first time.

- IODrvModbus

11 Modbus

11.8 Adding libraries for Modbus RTU communication

12 Remotely accessing the PLC

Modular PLCs XControl: XC-104-..., XC-204-..., XC-303-... XControl devices cannot be remotely accessed with XSOFT-CODESYS-3 Version 3.5.17. There are plans to add this function in a later version.

12 Remotely accessing the PLC

13 Web Visu XSOFT-CODESYS-3

Modular PLCs XControl: XC-104-..., XC-204-..., XC-303-... feature a web server used to deploy the visualization generated by XSOFT-CODESYS-3. The way the web visualization is handled is explained in the XSOFT-CODESYS-3 Help.

Keywords: CODESYS visualization / "Web Visu" object

13.1 Opening XSOFT-CODESYS-3 WebVisu

A description of the web visualization interface can be found in section 7.4, "Web visualization", of the manual for programming PLCs with CODESYS.

The visualization can be accessed through any of the Ethernet interfaces on the Modular PLCs XControl: XC-104-..., XC-204-..., XC-303-....

However, this requires for a corresponding webvisu.htm XSOFT-CODESYS-3 WebVisu project to be found on the device already.

If the device is addressed through Ethernet port ETH2 with the default IP address, for example, the XControl-specific web visualization call will be as follows:

Unencrypted: <http://192.168.138.248:8080/webvisu.htm>

Encrypted: <https://192.168.138.248/webvisu.htm>

If you have changed the IP address, replace the IP address in the "http:\\..." call with the address you have selected.

ATTENTION

The number of clients that can access the Modular PLCs XControl: XC-104-..., XC-204-..., XC-303-... simultaneously is limited to 10.

13.2 Selecting the XSOFT-CODESYS-3 WebVisu encryption type

The web server for XSOFT-CODESYS-3 projects can be accessed either with the HTTP or HTTPS protocol. The 3S CODESYSControl.cfg file specifies which of the protocols should be available.

This file can be found on the device, in the "\\home\\PlcRts" directory.

13 Web Visu XSOFT-CODESYS-3

13.2 Selecting the XSOFT-CODESYS-3 WebVisu encryption type

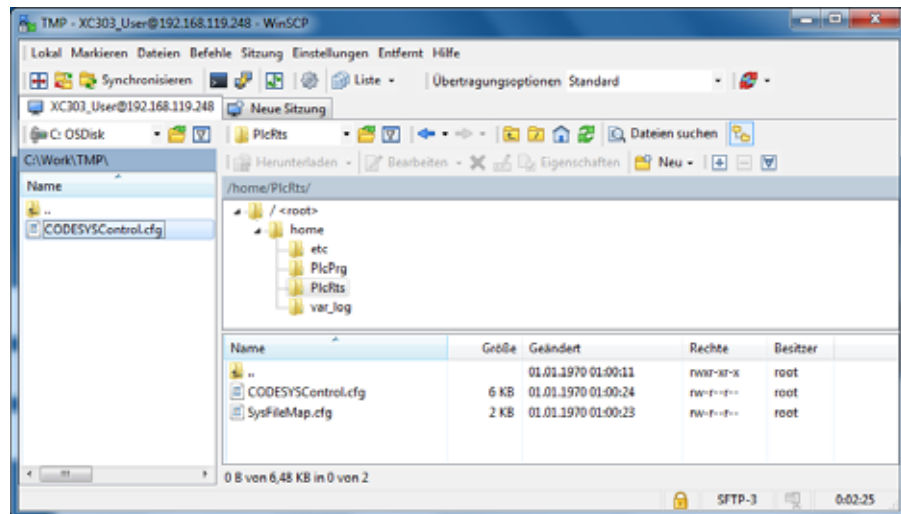

Figure 98: PlcRts directory on XControl

To change the protocol for the web server, follow the steps below:

Open the file and search for the entry for [CmpWebServer].

The Connection Type parameter will determine which protocols are permitted as follows:

ConnectionType=

0: Only HTTP connections allowed

1: Only HTTPS connections allowed

2: HTTP and HTTPS connections allowed

3: HTTP and HTTPS connections allowed, but access via HTTP will automatically be redirected to HTTPS.

```
OSPriority.High.End=155
#16 priority levles
OSPriority.AboveNormal.Base=156
OSPriority.AboveNormal.End=173
#16 priority levles
OSPriority.Normal.Base=184
OSPriority.Normal.End=201
#16 priority levles
OSPriority.BelowNormal.Base=202
OSPriority.BelowNormal.End=219
#8 priority levles
OSPriority.Low.Base=230
OSPriority.Low.End=239
#14 priority levles
OSPriority.Lowest.Base=240
OSPriority.Lowest.End=255

[CmpOpenSSL]
WebServer.Cert=server.cer
WebServer.PrivateKey=server.key
WebServer.CipherList=HIGH
WebServer.CertStoreBase=/home/etc/PKI/

[CmpwebServer]
FileUploadDirectory=/home/PlcPrg/visu
#EnableLogger=1
ConnectionType=2
#For connectiontype there are the following options:
#0: Only http-connections are possible
#1: Only https-connections are possible
```

14 Web Config Tool for XC-104-... and XC-204-...

The Web Config Tool can be used to configure XC-104-... and XC-204-... modular PLCs with operating system version V3.1.0.0 or higher. Access is possible with an up-to-date browser installed on a connected device or the PC.



Please note that Internet Explorer is not supported.

Security

The encryption uses a 2048-bit RSA key. This key will be generated on the device the first time it starts. Please note that the Web Config Tool cannot be used at all without this encryption.

Since there is no way to check a certificate in local IP ranges, the "Untrusted certificate" dialog box will be shown. Instead, you can check whether the certificate's digital thumbprint has changed so as to prevent man-in-the-middle attacks.

Remote use

The XControl Web Config Tool can be accessed through a remote browser.

14.1 Logging in to the Web Config Tool

In order to be able to access the Web Config Tool, you must know the IP address of the device that you want to configure. The device or the PC with which you want to access the XControl device must be in the same subnet as the XControl device.

The service runs on port 8375 and uses HTTPS. This means that if the device's IP address is, for example, "192.168.119.204", the URL will be "https://192.168.119.204:8375/#/login".

To open the Web Config Tool, follow the steps below.

After logging in, you can use the Web Config Tool as described below.

Password setup

If you reset the device to its factory settings, the Web Config Tool will ask you to create a password when you access the device. The default language will be English.



This means that the first person who logs in will be the person creating the password.

By default, there is no password.

14 Web Config Tool for XC-104-... and XC-204-...

14.1 Logging in to the Web Config Tool

The following screen will appear:

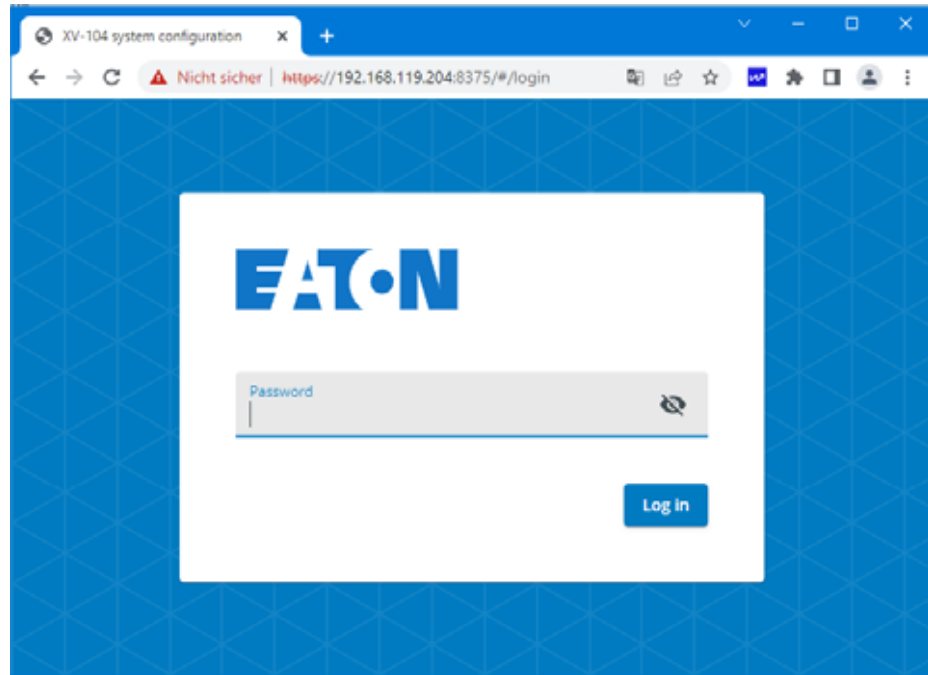

Figure 99: Enter password

The password must meet the following requirements:

- Minimum of 8 characters in length
- At least 1 number
- At least 1 uppercase letter
- At least 1 lowercase letter
- At least 1 special character, with the following characters allowed: ! @ # \$ ^ &



Please note that the password will not be accepted unless all the above conditions are met.

After creating the password, you will be automatically authenticated.

Authentication and session

Once you create a password, the login screen will be shown every time you access the Web Config Tool afterwards.



Passwords are created during initial commissioning.



Figure 100: Authentication with password

You can change the password on the "Device" configuration page.



After 15 minutes of inactivity, you will be logged out automatically. When this happens, the login screen will be shown with a message saying that your session expired.

14.2 Navigation

After logging in, the following page will appear:

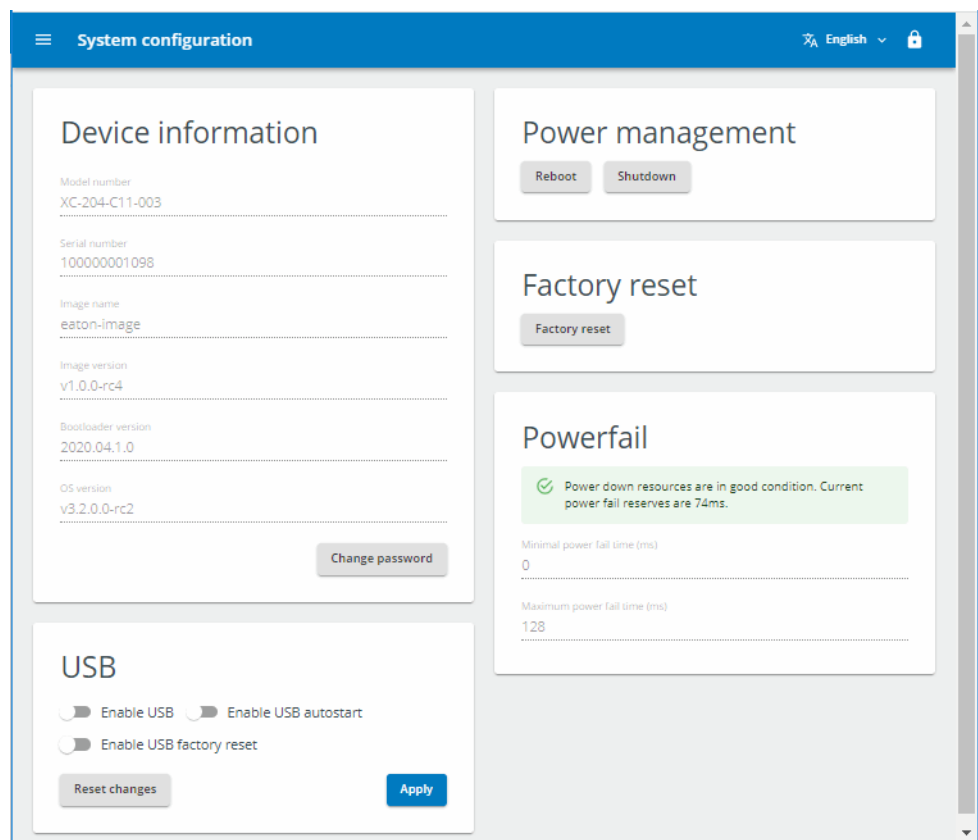



Figure 101: Web Config Tool start page

14 Web Config Tool for XC-104-... and XC-204-...

14.3 Setting a language

To navigate to a different page, you will need to click on the  button on the left in the top blue bar. Once you click on the button, a pane with all the configuration pages will appear as shown below. You can then access any configuration page from the pane.

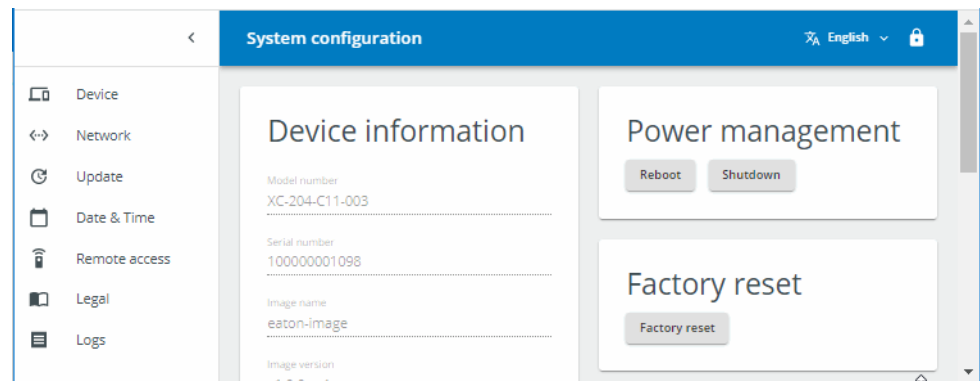



Figure 102: Web Config Tool start page with configuration page pane on the left

You can close the pane with the configuration pages at any time by clicking on the < arrow at the top right of the pane.

To log off, tap the  lock button in the upper blue bar.

14.3 Setting a language

As soon as the device is ready, the top blue bar will show the language selection drop-down menu for the Web Config Tool. As of this writing, German and English are available as languages. English will be selected by default.



Figure 103: English and German language selection options

14.4 Device configuration page – System configuration page

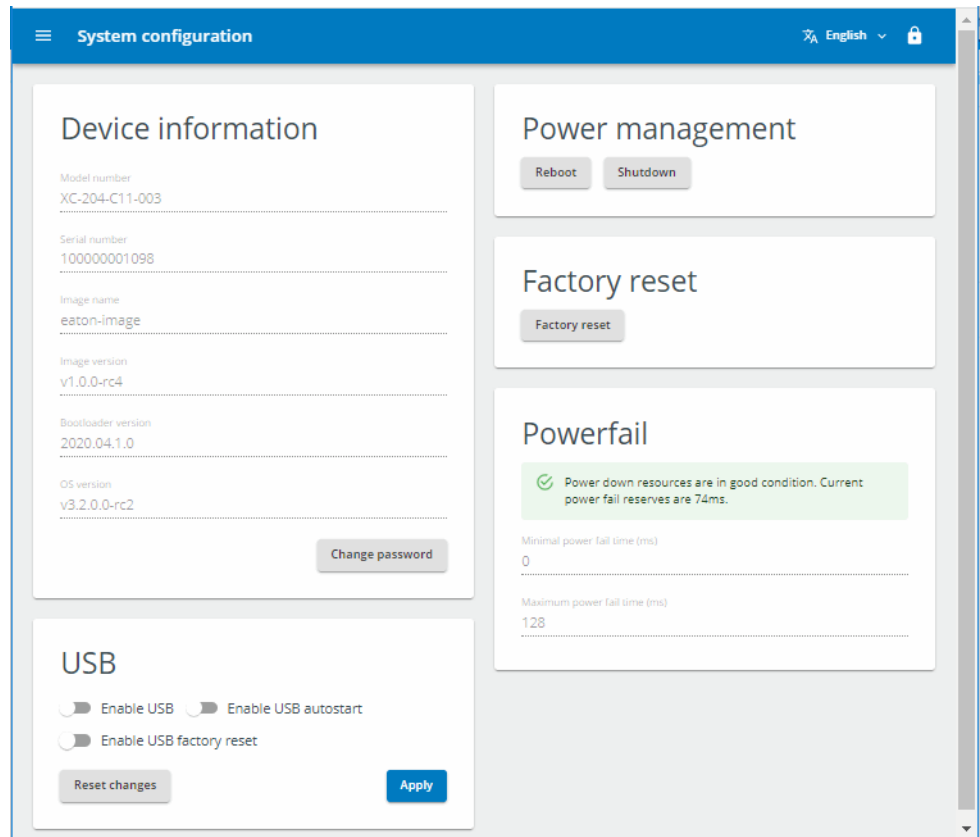

Figure 104: System configuration page with disabled USB interface

14 Web Config Tool for XC-104-... and XC-204-...

14.4 Device configuration page – System configuration page

14.4.1 Device information

"Device information" will show information regarding the device and the image currently being run. In addition, you can change the password for the web configuration by clicking on the "Change password" button.

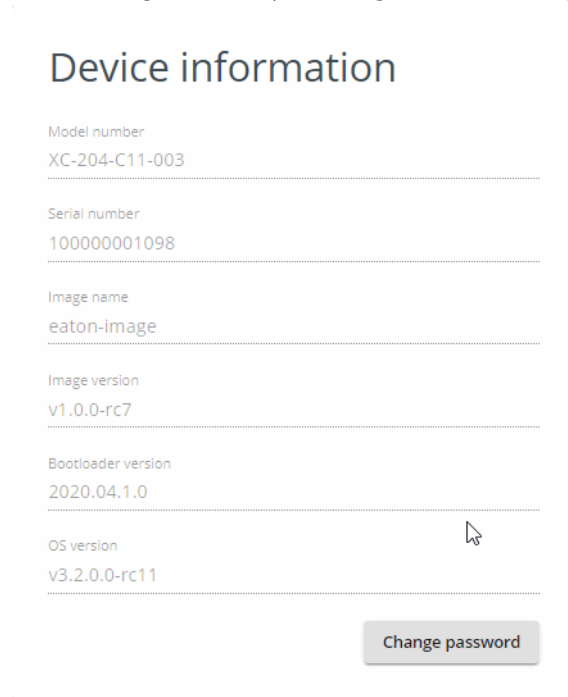

Model number	XC-204-C11-003
Serial number	100000001098
Image name	eaton-image
Image version	v1.0.0-rc7
Bootloader version	2020.04.1.0
OS version	v3.2.0.0-rc11

Change password

Figure 105: Device configuration page – Device information section

14.4.2 Changing / setting up passwords

If you reset the device to its factory settings, the Web Config Tool will ask you to create a password when you access the device. The following screen will appear:

Change password

Current password 

New password 

- ✓ At least 8 characters in length
- ✓ At least 1 digit
- ✓ At least 1 uppercase letter
- ✓ At least 1 lowercase letter
- ✓ At least 1 special character: (valid: ! @ # \$ ^ &)

Confirm new password 

Figure 106: Change password

Once you create a password, it will be possible to change it but not to delete it (unless you carry out a factory reset) – please refer to

14.4.3 USB interface activation

Enable USB

In the "USB" section, you can enable the USB interface by toggling the corresponding switch to the right and disable it by toggling it to the left. If the USB interface is not enabled, USB Autostart and USB factory resets will not be possible.

Enable/disable USB Autostart

The USB Autostart function is used to automatically start executable files on a plugged-in USB storage device when the device is booting up.

If USB Autostart is enabled, the system will search for shell scripts named "etn-startup.sh" in the root directory of the partitions on a plugged-in USB drive and run them with a GNU Bash interpreter.

14 Web Config Tool for XC-104-... and XC-204-...

14.4 Device configuration page – System configuration page

Enable/disable USB factory reset.

The ability to reset the device to factory settings will be enabled (i.e., available) if you toggle the "Enable USB factory reset" switch to the right. For information on how to reset the XControl device to factory settings, please refer to → Section "3.10 Factory resetting XC-104-... and XC-204-...", page 71.

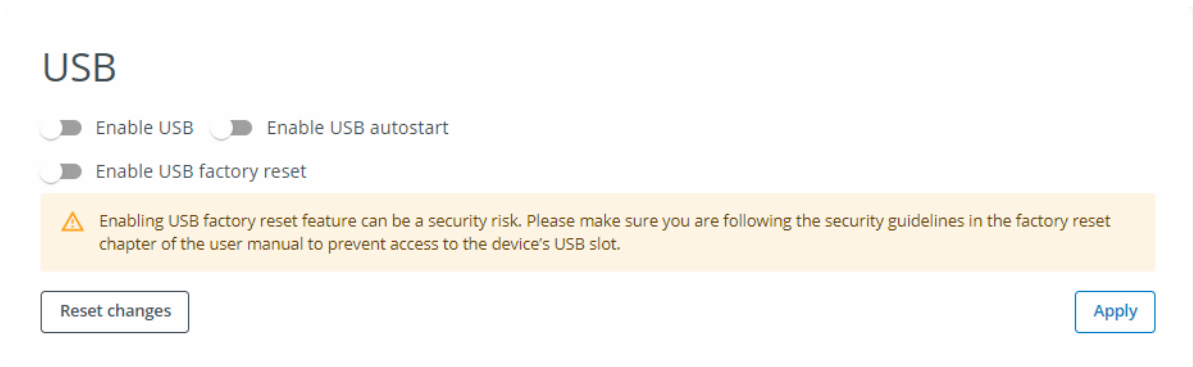

Figure 107: Device configuration page – USB section

14.4.4 Power management

You can restart and shut down the device in the "Power management" section. To prevent the device from being shut down or restarted accidentally, you will need to confirm these actions in a confirmation prompt.

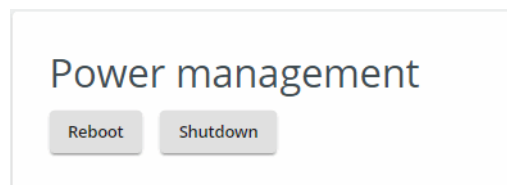

Figure 108: System configuration – Power management section

14.4.5 Factory reset

In the "Factory reset" section, you can reset your device directly to factory settings without the need for additional preparation. A confirmation prompt will appear after you click on the button. If you confirm the "factory reset," the prompt will disappear.

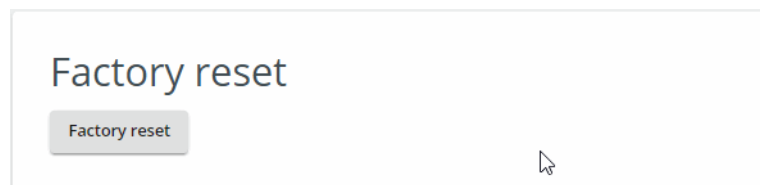

Figure 109: System configuration – Factory reset section

All Ethernet ports will be reset to their default settings. If a password has been set, it will be deleted.

A factory reset can also be carried out by plugging in a storage device into the device's USB port and booting the device – please refer to → Section “Enable/disable USB factory reset.”, page 141.

14.4.6 Powerfail

To keep data retentive, it will be copied from RAM to NVRAM when the device is switched off. As soon as the data has been stored, the time until the device is de-energized will be counted up. This time will be shown in the "Powerfail" section.

If this time falls below a value of 10 ms, an error message will appear in order to let you know that the data can no longer be stored in a retentive manner.

There are two possible causes for this error message:

1. The remaining time has decreased due to the components getting older.
2. The operating system is in an error condition.

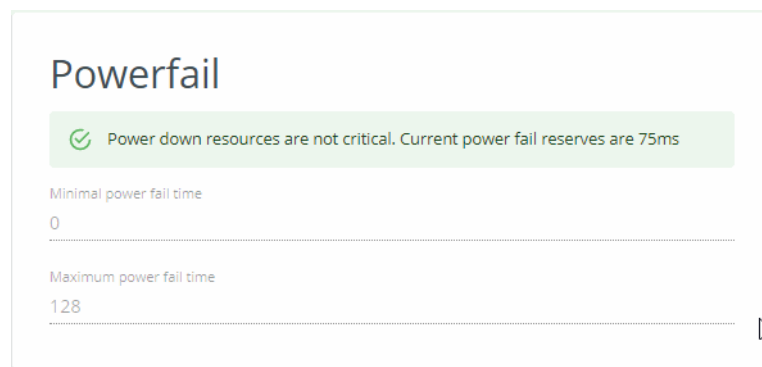

Figure 110: System configuration – Powerfail section

14.5 Network configuration page

The number of "Network interfaces" sections that you can use to set up the IP configuration for each interface will depend on the specific number of network interfaces on the device.

14 Web Config Tool for XC-104-... and XC-204-...

14.5 Network configuration page

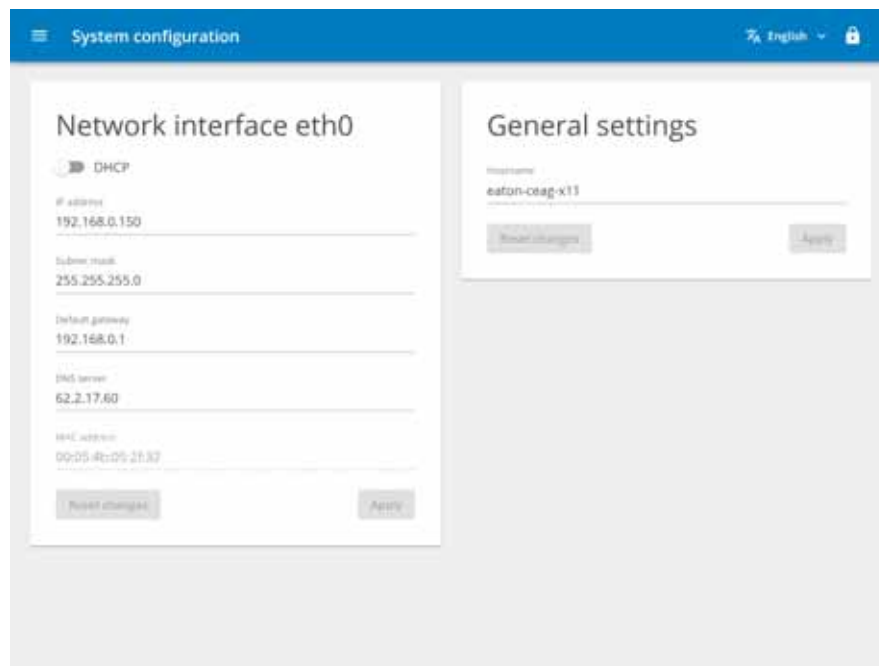

Figure 111: Network configuration page with one Ethernet interface

Change the device's IP address

If you change the configuration, you will be disconnected from the Web Config Tool. If this happens, you will need to log in again with the new IP address. There are two options: The first one is to use static address assignments, in which case you will have to assign an IP address, a subnet mask, a default gateway, and a DNS server. The second is to enable the DHCP service, in which case a configuration will be automatically requested from your network – please refer to → Section “14.5 Network configuration page”, page 143.

You can change the hostname in the "General settings" section. This name will be used for specific multicast DNS services. This type of service, which you can use to find the device without knowing the corresponding IP address, is provided with XSOFT-CODESYS-3.

14.6 Update configuration page

You can update the operating system and the bootloader under "Update." The runtime system cannot be updated with the Web Config Tool. It can only be updated with XSOFT-CODESYS-3.

You can upload a RAUC bundle in order to update the device's operating system or the bootloader. The file will have .raucb as an extension.

You can simply drag&drop the *.raucb file you want to use.



Do not turn off or unplug the device during the update!

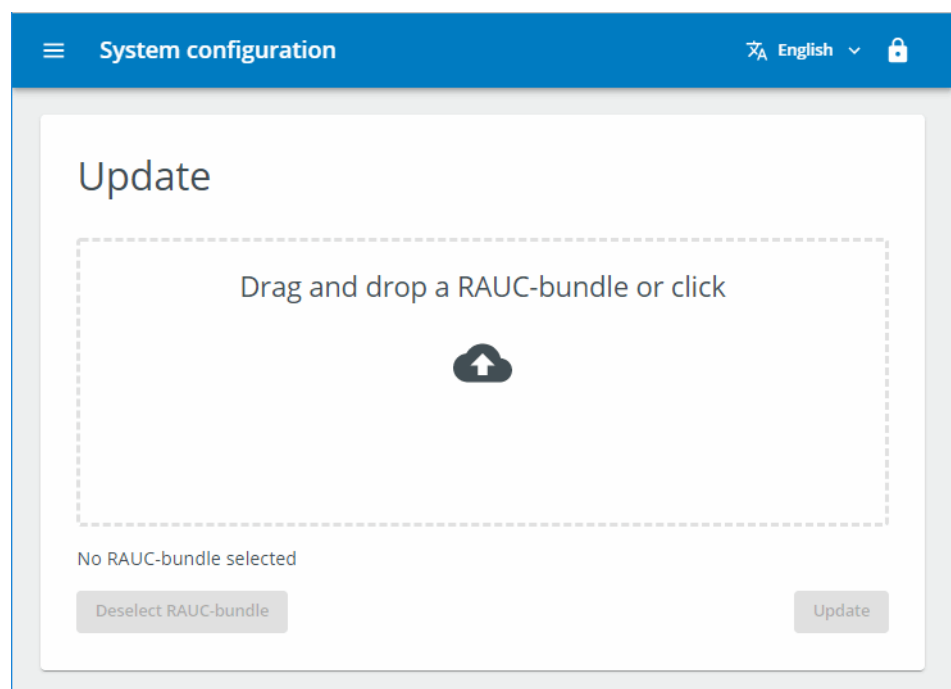

Figure 112: No RAUC bundle selected

If you have already uploaded a RAUC bundle, the name of the bundle will be shown here.

After selecting the package and tapping the "Update" button, it is important for you to remain on the page until the upload is completed. You can follow the corresponding progress on the first progress bar, as shown below.

You can follow the corresponding progress on the first progress bar, as shown below.

14 Web Config Tool for XC-104-... and XC-204-...

14.6 Update configuration page

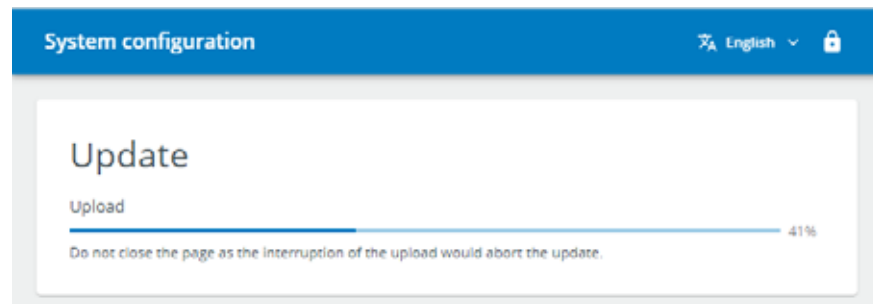

Progress display

Once the upload has been completed, the second bar will show the installation progress.

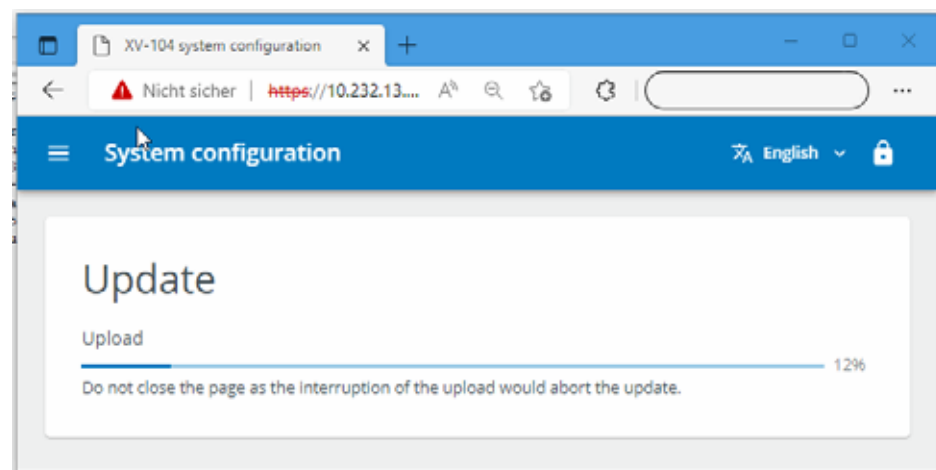

Figure 113: Update progress bar

As soon as the update has been completed, you will need to restart the device in order to run the new version.

- ▶ To do this, click on the "Restart" button shown after the update is completed.



Please note that you can only apply one update after each restart.

14.7 Date & time configuration page

The "Date & time" configuration page will show the current device time without taking into account the local device's time zone.

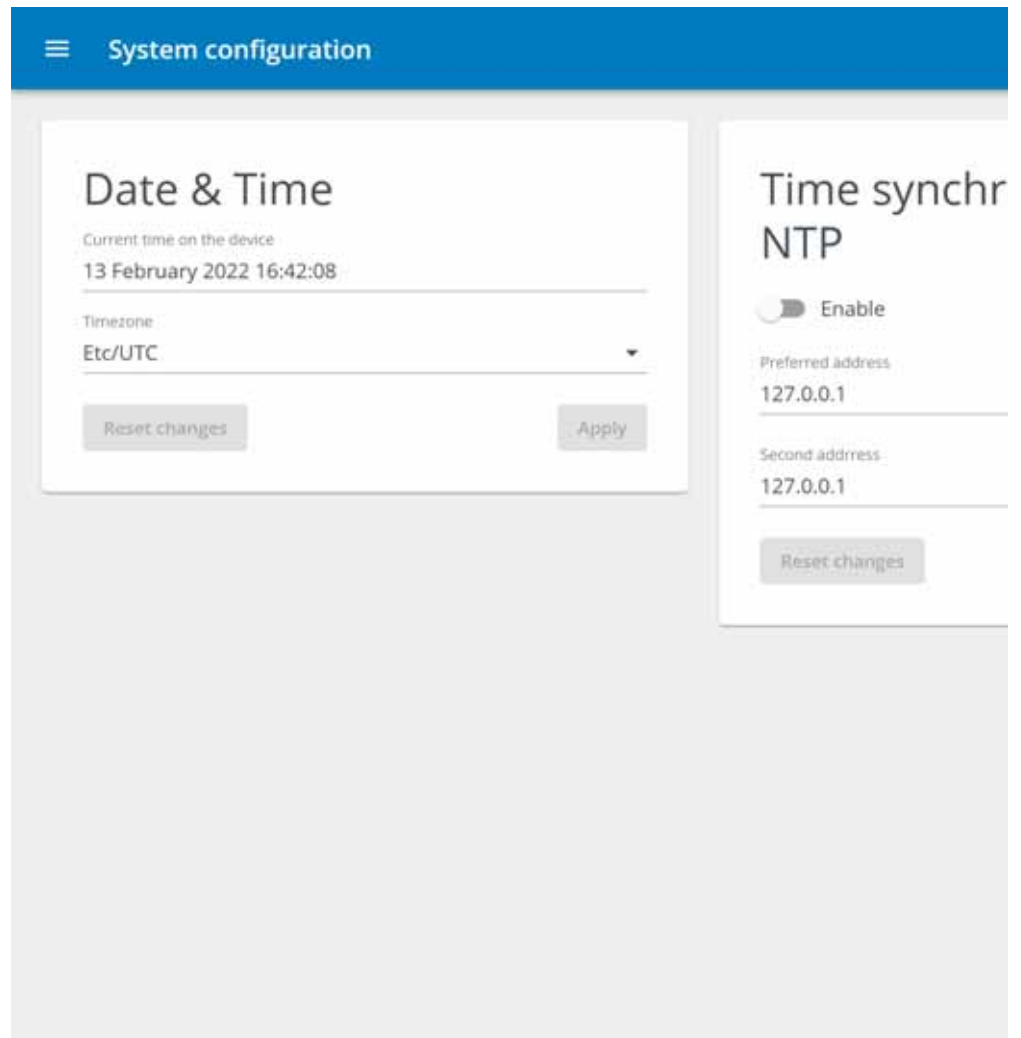

Figure 114: "Date & time" configuration page

14.7.1 Date & Time

You can set the time, including the corresponding seconds, and the time zone. If you change the time zone, the time shown above will not be re-calculated.

14.7.2 Time synchronization with NTP

In the "Time synchronization with NTP" section, you can enable NTP and select a preferred address and a backup address. The NTP service will then be used to correct the time and the system time every minute. This can also help counteract RTC drift if the device runs for multiple years or decades.

14.8 Remote access configuration page

You can use the "Remote access" configuration page to enable and disable the corresponding service.

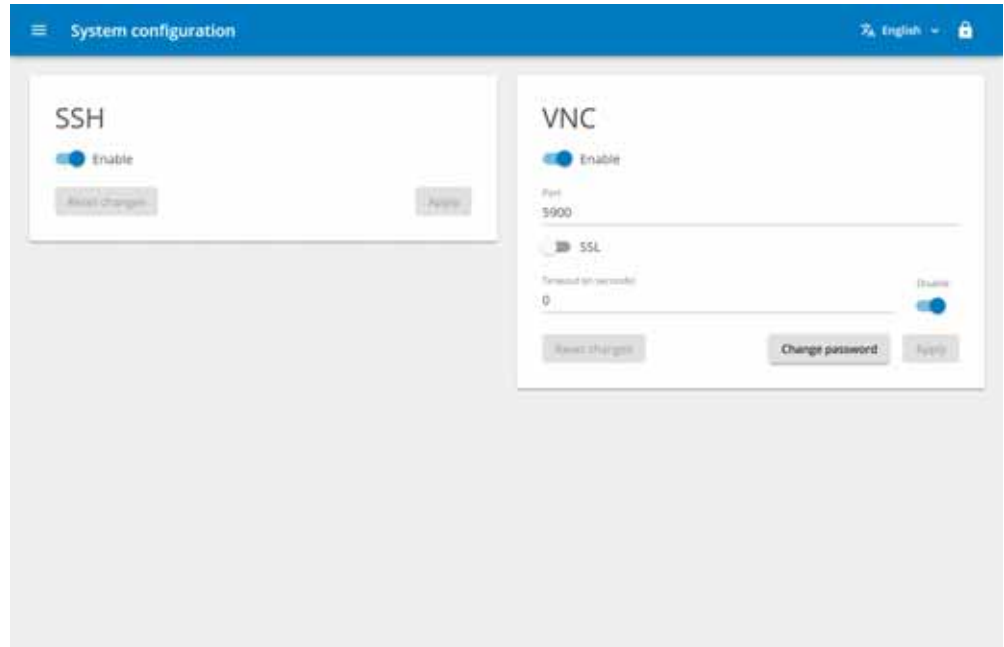

Figure 115: "Remote access" configuration page

14.8.1 SSH

You can enable and disable remote access in the "SSH" section.



Make sure to disable SSH after you no longer need it and the device is in a production environment. This will disable remote access and improve the device's security.

14.8.2 VNC

In the "VNC" section, you can enable/disable the service and define the corresponding login information, port, timeout, and encryption. The timeout is the time after which a client will automatically terminate the connection. If you change the password, a dialog box will appear so that you can enter the new password twice.



Make sure to disable VNC after you no longer need it and the device is in a production environment.

14.9 Legal configuration page

The "Legal" configuration page shows all open-source software packages delivered with the running image, as well as the corresponding versions. It also shows the licenses for the delivered software packages as applicable.

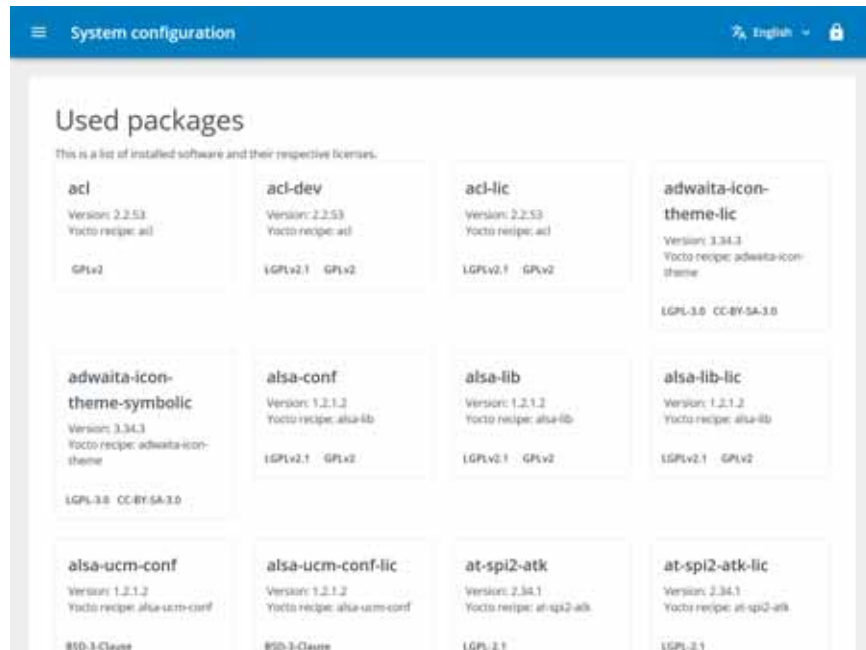

14.10 Logs configuration page

On the "Logs" configuration page, you can download various log files generated on the device. To download the log file, double-click on the "Download" button.

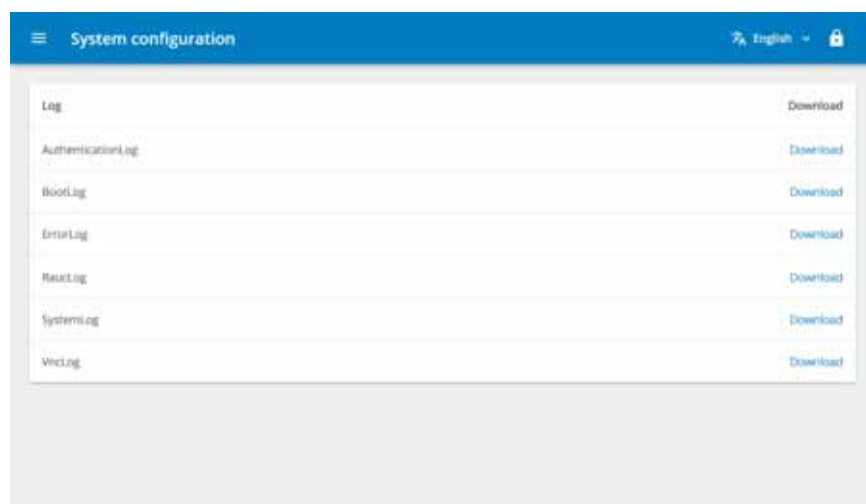

Figure 116: Stored log files

14 Web Config Tool for XC-104-... and XC-204-...

14.10 Logs configuration page

15 OPC UA

OPC Unified Architecture, or OPC UA for short, is a standardized communication protocol for exchanging data between machines that makes it possible to use all devices universally.

CODESYS V3.5.9 and higher supports OPC UA.

The OPC UA server is integrated into the PLC. When the PLC starts, the OPC UA server will be started automatically as well.

OPC UA's scope of functionality matches OPC DA's scope of functionality. The URL for the OPC UA server needs to be entered into the OPC UA client:

„opc.tcp://<IP-Address>:4840“

Just like with OPC DA, the symbol list needs to be set up in X-SOFT-CODESYS 3.

To run the OPC UA server, additional information needs to be loaded onto the PLC. The symbol configuration will be generated during the download for this purpose.

- Basic types of derived function blocks
- Contents of attributes assigned with compiler pragma directives
- Tag type (INPUT / OUTPUT / IN_OUT)

To generate the symbol configuration, follow the steps below:

- ▶ Select the application and open the context menu
- ▶ Click on "Add object" and "Symbol configuration."
- ▶ Please specify a file name.
- ▶ Enable the "Support OPC UA functionalities" option.
- ▶ Confirm with OK.

The symbol configuration editor will appear.

You can use this editor to define all the tags that should be transferred.

The symbol configuration will be updated with the next download or online change.

16 Libraries, function blocks and functions

The libraries contain IEC function blocks and functions that you can use, for example, for the following tasks:

- Data exchange through the CAN bus
- Controlling the real-time clock
- Determining bus load of the CAN bus
- Triggering interrupts
- Sending/receiving data through the interfaces



Codesys helps users with various functions and function blocks that are managed in libraries. There are available libraries for assistance with the following, for example:

- Field bus communication (z.B. CAN),
- Real-time clock functions
- Communication through serial interfaces
- File handling functions

The following libraries are available:

- EA_Network library for Ethernet
- IODrvEtherCAT for EtherCAT
- EA_CANOpen library for CANOpen
- IODrvModbus for ModbusRTU
- IODrvModbusTCP for ModbusTCP
- IODrvEthernet for ModbusTCP
- EA_CAN types (when using Eaton CAN devices)
- EA_CAN library with function blocks for CAN
- EA_XC303Events library for interrupt processing



Examples of libraries available to users:

- EA_CANOpen ,
- IODrvModbus,
- SysCom,
- SysFileAsync...

16.1 Using libraries

When creating a standard project, libraries with frequently used functions will be automatically added to the project.

This includes, for example, the Standard.lib library with known function blocks such as: counter, timer, trigger function blocks, etc.

Additional libraries that are added automatically include the IoStandard-Lib and 3SLicense-Lib libraries.

When you open a project, the following libraries will be copied to the library manager.

- 3SLicense (system library)
- Standard.lib
- IoStandard
- BreakPointLogging

If the application requires additional libraries, you will need to install them manually in the library manager.

When the project is saved, these libraries will be assigned to the project and will be available the next time you open the project.

16.2 Installing additional system libraries

If necessary, you can install additional libraries manually.

The following steps are required:

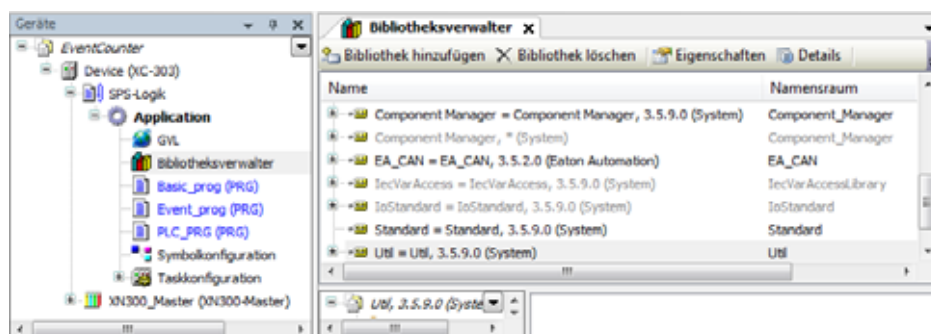

Figure 117: Libraries, installing manually

- ▶1. Make sure that the library you want to install is found on a folder on your PC.
- ▶2. In the configuration tree, double-click on "Library manager." Click on the "Add library" menu option.

16 Libraries, function blocks and functions

16.2 Installing additional system libraries

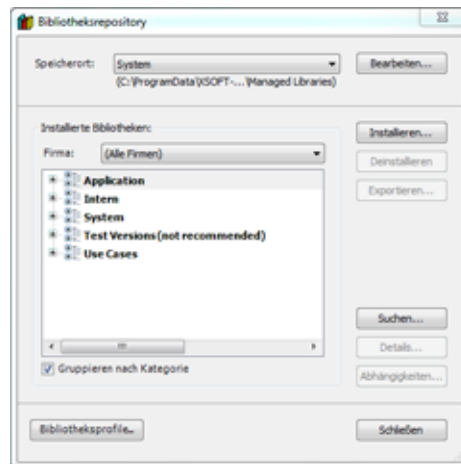

Figure 118: Adding a library to the library repository

- ▶3. Click on the "Install..." button.
- ▶4. In Explorer, select the library in the folder where it is stored.



- ▶5. Confirm with click on <Open>.
The new window will show the libraries available, depending on the target system.
- ▶6. Select "Add library."

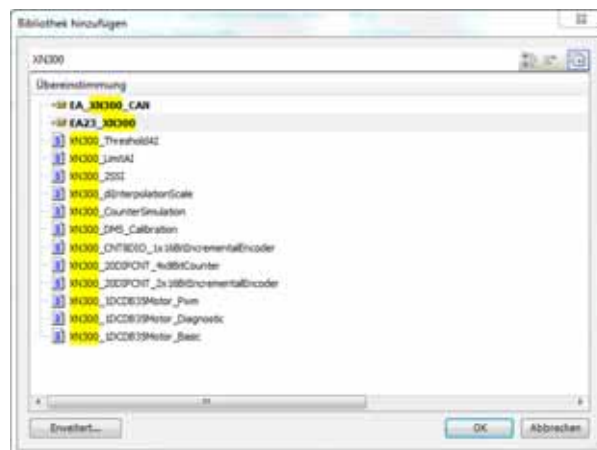

Figure 119: Search for a library in the library repository

- ▶7. To find the installed library faster, enter a search string into the search box (e.g., "XN300").
- ▶8. Select the library to install and click <OK>.

The library now appears in the Library Manager.

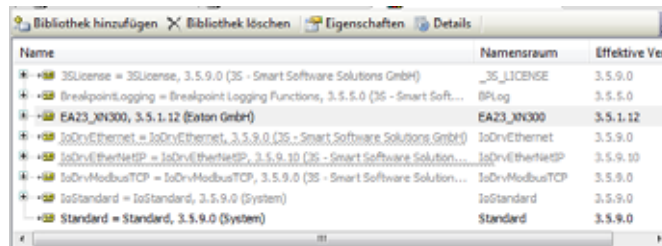

Figure 120: Search for a library in the library repository



In addition, users can create their own libraries in order to store frequently recurring tasks as functions or function blocks in them.

16.3 EA_Network.lib library

The EA_Network.lib library provides Ethernet interface configuration functions for all Eaton PLCs with Ethernet interfaces.



Manufacturer documentation for XSOFT-CODESYS-3, online help for EA_Network.lib library

16 Libraries, function blocks and functions

16.3 EA_Network.lib library

17 PLC shell commands

The PLC shell is a text-based PLC monitor. PLC shell commands for scanning particular information from the PLC are entered in an entry line and sent to the PLC as a string. The returned response string is displayed in a result window of the PLC shell. This functionality is used for diagnostics and debugging tasks.

17.1 Using PLC shell commands

To enter a PLC shell command, follow the steps below:

- ▶ Establish a connection to the device.
- ▶ In CODESYS, double-click on the "Device (XC303)" device in the configuration tree.
- ▶ Select the "PLC Shell" tab.
- ▶ Enter the PLC shell command into the input line below or click on the "..."
button and select the PLC shell command you want by double-clicking on it.
- ▶ Add other settings to the command if necessary, e.g. baud rate with `setcomconfig`.
- ▶ Press the Return button.

The result will be displayed.

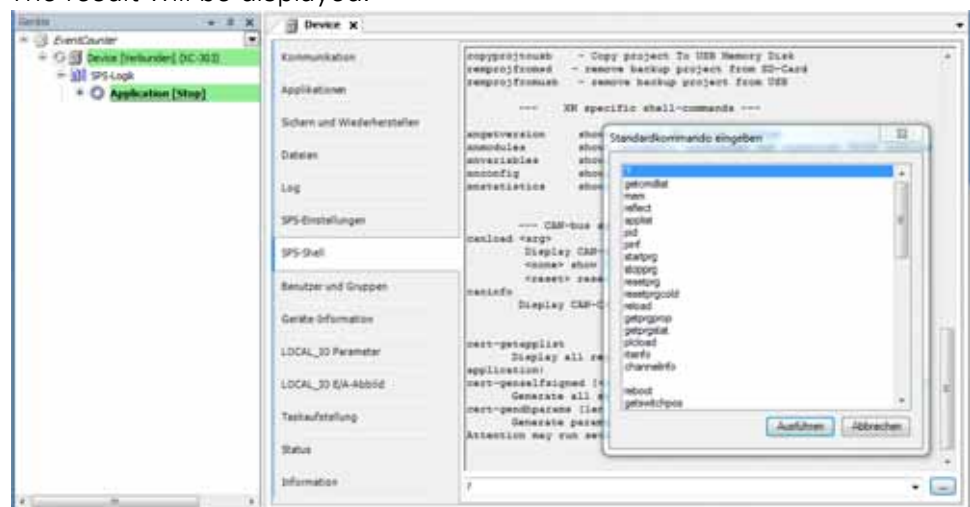

Figure 121: PLC Shell tab with results for the "?" browser command

17 PLC shell commands

17.2 List of PLC shell commands (updated)

17.2 List of PLC shell commands (updated)

The following PLC shell commands are available.

Table 14 PLC shell commands in alphabetical order

Attribute ID	Description
?	Get a list of implemented commands
applist	Print List of currently loaded applications.
caninfo	Display CAN Controller Informationen
canload <arg>	Display of the loading of the CAN fieldbus <arg> <none> show CAN-Bus load. <reset> reset CAN-Bus load statistics.
canshow ²⁾ <arg>	Shows CAN controller statistics <1>; <2>; <none> for both controllers
canshowReset ²⁾ <arg>	Resets CAN controller statistics <1>; <2>; <none> for both controllers
cert-createsr ²⁾ [<number in search result with "cert-getapplist">]	Generates CSR files for all applications.
cert-export ²⁾ <trust level>	Exports the specified certificate [<number in search result with "cert-getcertlist">]
cert-getapplist	Shows all registered certificates being used (ID of component and use) Display all registered applied certificates (Component ID and application)
cert-getcertlist ²⁾ [<trust level>]	Lists all certificates with the specified trust level. If you do not specify a trust level, all certificates will be listed. Available trust levels <ul style="list-style-type: none"> • untrusted: Untrusted certificates • trusted: Trusted certificates • own: The PLC's certificates • quarantine: Certificates with a trust level (trusted / untrusted) that could not be clarified with a validation. This will result in incoming connections being rejected.
cert-genselfsigned [<number retrieved by "cert-getapplist"> <expdays=>]	Generates self-signed certificates; you can use expdays= to specify the certificate's validity period Standard value: 365 days Generate all self signed certificates
cert-gendhparams [len in bits]	Generates the parameters for the Diffie-Hellman key exchange Important: This operation can take several minutes! Generate parameters needed for Diffie-Hellman key exchange. Attention may run several minutes!
cert-import ²⁾ <trust level> <Dateiname.cert>	Imports the specified certificate.
cert-remove ²⁾ <trust level> <number in search result with "cert-getcertlist" or "all">	Removes the specified certificates.
channelinfo	Return communication channel information.
clearsram ²⁾ <segment number>	Initializes and flags the SRAM segment or the whole SRAM as free. The segment number can be retrieved with the following shell commands: "getsramlayout" or "all":
copyprojtosd	Copy the (boot) project onto a Multi Media Card (incl. directory structure/project directory)
copyprojtousb ¹⁾	Copy the (boot) project onto the USB drive (incl. directory structure/project directory)
getcmdlist	Used internally to display all available commands.
getdhcpstate ²⁾	Returns the status of the Ethernet interface(s) in regard to whether DHCP is enabled Example: eth0 : DHCP Enabled = NO
gethwinfo	Show hardware information

17 PLC shell commands

17.2 List of PLC shell commands (updated)

Attribute ID	Description
getdevicebrandname ²⁾	Returns the device name Example: Device Brand Name = XC-204-C11-003
gethostname ²⁾	Returns the host name Example: Host name = eaton-xc204
getinitplcsettings ²⁾	Returns the settings for the boot project Example: BP_OVERWRITE=1 BP_COPY_FROM_USB=1 BP_ALLOW_DISABLE_START=1 RTS-Update-Settings FW_ONLY_NEWER_VERSION=0 FW_FORCED_OVERWRITE=0 FW_INSTALL_FROM_USB=1 RTS-Startup-Settings RTS_START_DELAY_SEC=0 RTS_DISABLE_START=0 RTS_SUPERVISE=1
getipadress ²⁾ <adaptername>	Shows the IP address of the Ethernet interfaces (= Ethernet adapters)
getipconfig	Display Ethernet address
getipdns	Display current DNS address
getipgateway	Display Gateway address
getntpconfig ²⁾	Returns the settings of the NPT server daemon Example: Preferred Server 127.0.0.1 Min Poll 4 Max Poll 10 Standard Server 127.0.0.1 Min Poll 4 Max Poll 10 Ntp Service: stopped
getsramlayout ²⁾	Example: --- SRAM layout: Address=0xb6801000 Segment[0]: Tag=TAG_RETAIN_FREE, Size=32488, Guid=00000000-0000-0000-0000-000000000000
getserial ²⁾	Shows the device's serial number.
getsshstate ²⁾	Shows the configured state for the encryption Example: SSH = disabled
getswitchpos ²⁾	Shows the current switch position Example: Switch position: RUN
getprgprop	[not implemented, yet]
getprgstat [<app name> <app index>]	Get the status of one specific or all loaded applications.
getrtc	Display data and time [YY:MM:DD] [HH:MM:SS]
getsslversion ²⁾	Shows which OpenSSL version was used for the encryption Example: OpenSSL 1.1.1n 15 Mar 2022
gettimezone	Show actual timezone information (offset to UTC)
getversion	Show device versions list
listadapters ²⁾	Shows the available Ethernet interfaces (= Ethernet adapters).
mem <address> [<size>]	Shows the free memory on disk_sys. Print Hexdump of specified memory region
ntpsetpolltime ²⁾ <arg>	NTP polltime <arg> = Can be used to set to preferred (0=normal,1=preferred) minpoll maxpoll

17 PLC shell commands

17.2 List of PLC shell commands (updated)

Attribute ID	Description
ntpsetserver ²⁾ <arg>	Configures the NTP server address <arg> = Preferred server address (0= DNS name or 1= IP address)
ntpstart ²⁾	Starts or refreshes the NTP server daemon.
ntpstop ²⁾	Stops the NTP server daemon.
pid [<app name> <app index>]	Output project ID
pinf [<app name> <app index>]	Output project information
plcload ¹⁾	Display system performance: CPU usage [%]
reboot	Accept changes (registry save) and restart PLC
reflect ¹⁾	Mirror current command line for test purposes.
reload [<app name> <app index>]	Reloads the boot application
remprojfromsd	Deletes the backup project from the microSD card
remprojfromusb	Deletes the backup project from the USB drive
resetprg [<app name> <app index>]	Reset user program
resetprgcold [<app name> <app index>]	User program cold reset
restoresram ²⁾ <filename>	Restores the entire SRAM content from the file.
restoreretains ²⁾ [<applicationname>]	Restores retained data from file(s) [optionally only for the specified application].
rtc-get ²⁾	Returns the UTC universal time with the DateTime string.
rtc-set ²⁾	Sets the UTC universal time with the DateTime string (see ISO 8601)
rtsinfo	Returns information on the runtime system, e.g., the processor and the version of the runtime system.
saveretains ²⁾ [<applicationname>]	Saves retained data in file(s) [optionally only from the specified application].
savesram ²⁾ <filename>	Saves the entire SRAM content in a file
setipdns	Set DNS address [setipdns adr1.adr2.adr3.adr4]
setipaddr <arg>)	Set ip-address (<arg> = AdapterNo Adr1.Adr2.Adr3.Adr4)
setipbroadcast <arg>	Set ip of broadcast address (<arg> = AdapterNo Adr1.Adr2.Adr3.Adr4)
setipnetmask <arg>	Set ip-subnetmask (<arg> = AdapterNo Adr1.Adr2.Adr3.Adr4)
setipgateway <arg>	Set ip default gateway (<arg> = AdapterNo Adr1.Adr2.Adr3.Adr4)
setrtc ¹⁾	Set date and time [YY:MM:DD] [HH:MM:SS]; e.g.setrtc 03:07:24 10:46:33
settimezone <arg>	Setting new timezone information (<arg> = offset to UTC)
showsecuritysettings ²⁾	Shows the list of all security settings and the current configuration.
showtimezones ²⁾	Shows a list of selectable time zones.
sessinfo-getcnt ²⁾	Retrieves the number of data sets with session information.
sessinfo-list ²⁾	Lists all data sets with session information.
setdhcpstate ²⁾ <arg>	Set DHCP on/off (<arg> = AdapterName)
setinitplcsettings ²⁾ <arg> <val>	Assigns the <val> value to the <arg>s InitPlc setting.
setsshstate ²⁾ <arg>	Enable encryption. SSH enabled: <arg>=1; SSH disabled: <arg>=0
sshdisable ²⁾	Disable encryption
sshenable ²⁾	Enable encryption.
sshstate ²⁾	Shows the configured state for the encryption Example: SSH = disabled
startprg	Start user program

17 PLC shell commands

17.2 List of PLC shell commands (updated)

Attribute ID	Description
stopprg	Stop user program
storagestate ²⁾	Shows the storage state. Example: USB Storage Devices mounted: 0 SD Storage Devices mounted: 0
usbautostartdisable ²⁾	Disables the USB interface; USB Autostart=disabled
usbautostartenable ²⁾	If a USB data storage device is plugged into the USB port, projects will be started there automatically; USB Autostart=enabled
usbdisable ²⁾	Disables the USB interface.
usbenable ²⁾	Enables the USB interface; a USB data storage device can be read.
usbstate ²⁾	Shows the USB state Example: USB Storage=enabled USB Autostart=enabled
unmountall ²⁾	Terminates the connection to all active USB partitions.
xngetversion	Shows version information; shows current XN driver version
xnmodules	shows currently configured and connected SDIAS modules
xnvariables	shows XN module variables
xnconfig	shows XN module configuration variables
xndebug ²⁾	Example: Debug level is set to 3

- 1) You can access help with extended information for this PLC shell command in CODESYS. Enter a question mark followed by a space before the command e.g.: ? plcload in the command line of the PLC browser
- 2) Available for devices with runtime system version 3.5.17 or higher

17 PLC shell commands

17.3 CPU load shell commands

17.3 CPU load shell commands

plcload

The `plcload` PLC shell command provides information on the current CPU-system load.

The "SchedGetProcessorLoad" function from the Codesys V3 CmpSchedule library provides the processor load.

A utilization of more than 95 percent can cause a failure of the serial and Ethernet communication and/or an impairment of the real-time response.

canload

The `canload` PLC shell command shows the CAN bus load.

`caninfo` shows the CAN buses' baud rates and states.

You can also get information regarding the CAN bus with the `CAN_GetBusLoad` and `CAN_GetBusState` functions in the `EA_CAN` library.

18 Interferences

This section provides troubleshooting information for your Modular PLCs XControl: XC-104-..., XC-204-..., XC-303-... in case it does not behave as expected.

Fault	Cause	Remedy
XControl will not boot up	There is no 24 VDC supply voltage	Check the input wiring. Switch on XControl.
PLC LED = red; solid	Indicates a runtime system error. Device hangs on startup; the runtime system does not start, a connection cannot be established through XSOF CODESYS; LED PRG = OFF, Cause 1: Invalid OS version loaded; the OS version on the device is too new/old to support the respective PLC runtime system. Cause 2: The device's last restart was triggered by a hardware watchdog timeout. In both cases, a LOG file will be written to /var/log/codesyscontrol.log	Cause 1: Install the appropriate operating system for the runtime system. Cause 2: Start the device manually; if the fault occurs again, check the application for errors that trigger the watchdog. If necessary, check whether the boot application version matches the runtime system version.
	The runtime system starts, PRG LED = ON or OFF, Cause: Retentive data could not be loaded. Additional information can be found in the LOG file, which can be read with XSOF CODESYS.	Log in to the device through XSOF CODESYS and read the log file
LED PRG = ROT	Indicates an application error. <ul style="list-style-type: none"> • The attempt to load the boot project failed. • An exception occurred in the application. Additional information can be found in the LOG file, which can be read with XSOF CODESYS.	Log in to the device through XSOF CODESYS and read the log file

18 Interferences

19 Maintenance

19.1 Cleaning and maintenance

The devices are maintenance-free.
However, the following work may be necessary:

- Cleaning the device when soiled.



CAUTION POINTY, SHARP OBJECTS AND CORROSIVE LIQUIDS

Do not use any pointy or sharp objects (e.g., knives) for cleaning. Do not use aggressive or abrasive cleaning products or solvents.

Make sure that no liquids get into the device (short-circuit hazard) and that the device is not damaged in any way.

- ▶ Carefully clean the device with a clean, soft, damp cloth. If there are any spots that are proving difficult to get off, spray a little dishwashing liquid on the damp cloth first.

19.2 Repairs

For repairs, please contact your vendor or Eaton's Technical Support.



CAUTION DESTRUCTION

The device should only be opened by the manufacturer or by an authorized repair center. Operate the device until only with the enclosure fully closed and sealed.

Contact your local supplier or Eaton technical support for repairs.

Use the original packaging to ship the device.

19.3 Storage and transport



CAUTION UV LIGHT

Plastics will become brittle when exposed to UV light. This artificial aging will reduce the device's lifespan. Protect the device from direct sunlight and other sources of UV radiation.



**CAUTION
SHORT-CIRCUIT HAZARD**

If the device is or has been exposed to environmental fluctuations (ambient temperature, air humidity), condensation may form on or inside it. As long as this condensation is present, there will be a short-circuit hazard.

Do not switch on the device when it has condensation in or on it.

If the device has condensation in or on it, or if the panel has been exposed to environmental fluctuations, let the panel settle into the existing ambient temperature before switching it on. Do not expose the device to direct thermal radiation from heating appliances.

The ambient conditions must be met when transporting and storing the device.

The ambient air temperature for storage / transportation must not exceed the maximum specified limit:



Before commissioning

If storing/transporting the device in cold weather conditions or in such a way that it will be exposed to extreme differences in temperature, make sure that no condensation forms on or inside the device.

If there is condensation in or on the device, do not switch on the device until it is completely dry.

- ▶ Use the original packaging to ship the device.

The device is sturdily built, but the components inside it are sensitive to excessively strong vibrations and/or mechanical shock.

Accordingly, make sure to protect the device from mechanical loads that exceed the scope of the unit's intended use.

The device should only be transported in its original packaging after being packed properly.

19.4 Disposal



CAUTION

Installation requires qualified electrician

IMPORTANT!

Dispose of recyclables as required by your local recycling regulations.

Devices no longer being used must be professionally disposed of as per local regulations or returned to the manufacturer or the relevant sales office.

19 Maintenance

19.4 Disposal

20 Appendix

20.1 Dimensions and weights

20.1.1 XC-303-...

		XC-303-...
Dimensions (H × D × W)	mm	104.7 × 72 × 50
	inch	4.12 × 2.83 × 1.97
Space units (SU) width		4 SU
Weight	kg	0.3
	lb	0.66
Mounting		DIN-rail IEC EN 60715, 35 mm
Mounting position		Vertical, upright

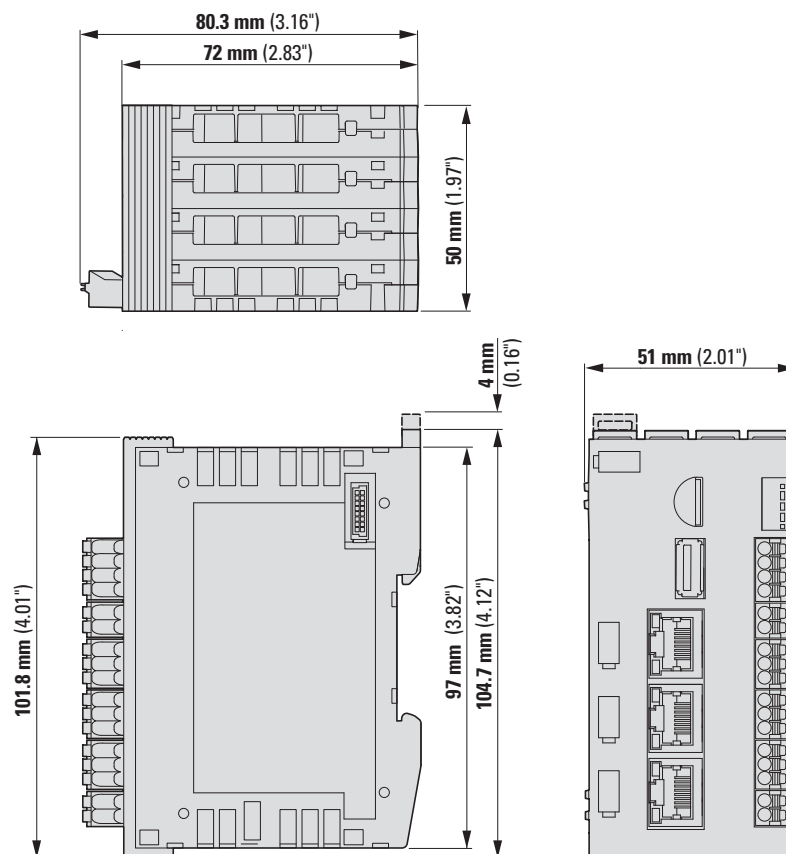

Figure 122: Dimensions XC-303-...

20 Appendix

20.1 Dimensions and weights

20.1.2 XC-104-..., XC-204-...

		XC-104-..., XC-204-...
Dimensions (H × D × W)	mm	104.7 × 72 × 23
	inch	4.12 × 2.83 × 0.91
Space units (SU) width		2 SU
Weight	kg	0.11
	lb	0.24
Mounting		DIN-rail IEC EN 60715, 35 mm
Mounting position		Vertical, upright

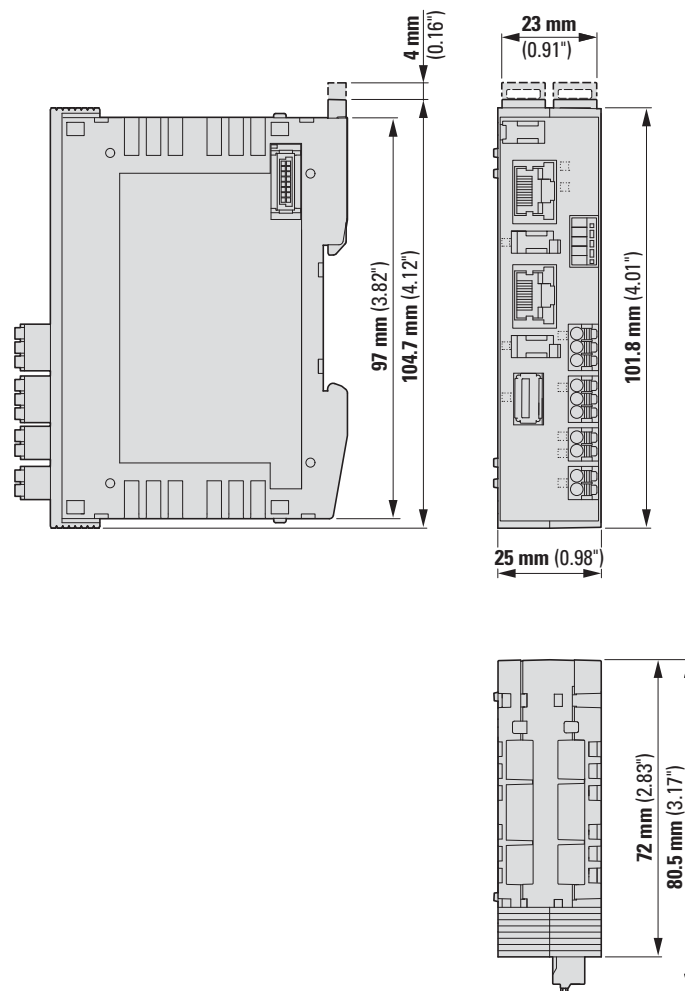

Figure 123: Dimensions XC-104-..., XC-204-...

20.2 Approvals and national approvals

Modular PLCs XControl: XC-104-..., XC-204-..., XC-303-... and XN300 system devices are approved for use in several countries and regions.

Approvals and declarations

cUL	cULus (pending; expected file No.: E205091)
CE	The devices in the XControl series of products comply with all applicable European Union (EU) Directives and feature the CE marking.

20.3 Technical specifications

20.3.1 General ambient conditions

	XC-104-...	XC-204-...	XC-303-...
Ambient climatic conditions			
Standards	IEC/EN/DIN EN 61131-2	IEC/EN/DIN EN 611-2	IEC/EN/DIN EN 61131-2
Ambient temperature	-20...+60°C		-20...+55°C
Storage temperature	-25...+70°C		-40...+80°C
Mounting position	horizontal and vertical, relative to the DIN-rail Derating must be taken into account for vertical mounting		horizontal, relative to the DIN-rail
Relative humidity, non-condensing (IEC/EN 60068-2-30)	5...95%		
Air pressure (in operation)	max. 2000m	max. 2000m	max. 2000m
Ambient mechanical conditions			
Protection Style	IEC: IP20		
Vibration resistance			
constant amplitude (5 - 8.4 Hz)	±3.5 mm	±3.5 mm	±3.5 mm
Constant acceleration (8.4 - 150 Hz) g	±1.0	±1.0	±1.0
Shock resistance half sinewave, 15 g/11 ms	18 impact resistances	18 impact resistances	9 impact resistances
Drop / drop height (IEC EN 60068-2-31)	50 mm	50 mm	50 mm
Free fall, packaged (EN60068-2-32)	0.3m	0.3m	0.3m
Overvoltage category	II	II	II
Pollution degree	2	2	2
Insulation resistance (UL61010-2)	-	-	500 V _{eff}
Connection terminals			
Plug-in terminal block			
Terminal capacities			
Spring-cage terminals			
solid	0.2 - 1.5mm ²		
Flexible with uninsulated ferrule	0.25 - 1.5mm ²		
Flexible with insulated ferrule	0.25 - 0.75mm ²		
Collar	d≤ 2.8mm		
AWG	24-16		
Strip length	10mm		
PLC			
Microprocessor PLC	NXP CORTEX A7 Single with 800 MHz + CORTEX M4 with 200 MHz	NXP CORTEX A7 Dual with 1 GHz + CORTEX M4 with 200 MHz	Freescale CORTEX A7 Dual core with 960 MHz
Memory			
Program memory	eMMC-FLASH: 2 GB		QSPI-FLASH: 128 MB
Cache memory	DDR3L-RAM: 256 MB	DDR-RAM: 512 MB	DDR-RAM: 512 MB

	XC-104-...	XC-204-...	XC-303-...
Data memory	NVRAM, depending on the PLC version: 4 to 32 kBytes		NV-RAM: 128 kByte
Retain/Persistent data	4 kByte	32 kByte	96 kByte
Operating System	Embedded Linux Version 4.14 or higher	Embedded Linux Version 4.14 or higher	Embedded Linux Version 3.12 or higher
Watchdog	Yes	Yes	Yes
RTC (Real Time Clock)	Yes	Yes	Yes
External storage devices			
Mikro Secure Digital Card	–	optional	Yes
USB Drive	Yes	Yes	yes, optional
PLC status indication	LED, two-colored, green, red	LED, two-colored, green, red	LED, single-colored, green LED, single-colored, red
System bus			
Maximum number of bus modules	6	16	32
I/O image table refresh rate	< 1ms	< 1ms	< 1ms
Ethernet interfaces			
Terminal type	RJ45	RJ45	RJ45
Baud rate			
ETH0, ETH1	10/100MBit/s	10/100MBit/s	10/100MBit/s
ETH2	–	–	10/100/1.000MBit/s
Galvanic separation	ETH0 closed	ETH0...1 closed	ETH0...2 closed
From each other	–	Yes	Yes
System bus	Yes	Yes	Yes
U _L supply voltage I/Q1...I/Q4	–	I/Q1...I/Q2, yes	I/Q1...I/Q4, yes
RS485	–	Yes	Yes
CAN1	–	Yes	Yes
CAN2	–	–	Yes
Local inputs	–	Yes	Yes
Local outputs	–	Yes	Yes
Terminal type	RJ45		
USB interface			
Type of interface	USB 2.0 Host Type A, downstream port		
Power supply for connected devices:			
Rated operating voltage	5 V DC (-5% +10%)	5 V DC (-5% +10%)	5 V DC (-5% +10%)
max. current	500 mA	500 mA	100 mA
Galvanic separation from			
System bus	no	no	no
POW	no	no	no
U _L supply voltage I/Q1...I/Q4	–	no	Yes
RS485	–	no	Yes
CAN1	–	no	Yes

20 Appendix

20.3 Technical specifications

	XC-104-...	XC-204-...	XC-303-...
CAN2	–	–	no
Local inputs	–	no	Yes
Local outputs	–	no	Yes

Electromagnetic compatibility		XC-104-...	XC-204-...	XC-303-...
immunity				
ESD	Contact discharge	6 kV, criteria B	6 kV, criteria B	4 kV
XC-303-...: (IEC/EN 61000-4-2)	Air discharge	8 kV, criteria B	8 kV, criteria B	8 kV
XC-204-...: (EN 61131-2:2008)				
XC-104-...: (EN 61131-2:2008)				
Electromagnetic fields (RFI) criteria A				
0.8 – 1.0 GHz		0.08 – 1.0 GHz: 10 V/m	0.08 – 1.0 GHz: 10 V/m	0.8 – 1.0 GHz: 10 V/m
1.4 – 2.0 GHz		1.4 – 6.0 GHz: 3 V/m	1.4 – 6.0 GHz: 3 V/m	1.4 – 2.0 GHz: 3 V/m
2.0 – 2.7 GHz				2.0 – 2.7 GHz: 1 V/m
Burst (EN 61131-2, Level 3) criteria B	POW	2 kV	2 kV	2 kV
	ETH 0...2 ¹⁾	1 kV	1 kV	1 kV
	Local inputs/outputs ¹⁾	1 kV	1 kV	1 kV
Surge, (POW, symmetrical, asymmetrical	0.5kV; XC-104-.../XC-204-...: 61000-6-2, criteria B	0.5kV; XC-104-.../XC-204-...: 61000-6-2, criteria B	0.5kV; XC303-...: (EN61131-2, Level 1), criteria B
	ETH0 to 2/CAN/RS-485, balanced ¹⁾	1kV	1kV	1kV
	Local inputs/outputs, balanced	–	–	1kV
Cable dependant interference, induced by high frequency fields EN61131-2		10 V	10 V	10 V

1) If provided

20.3.2 Power supply on devices and on system bus

POW power supply of the CPU	XC-104-...,	XC-204-...	XC-303-...
Power loss ride through			
Duration of dip	10 ms	10 ms	20 ms
Rated operating voltage			
Rated value U_e	24 V DC	24 V DC	24 V DC
admissible range	19.2...30V DC	19.2...30V DC	18...30V DC
Residual ripple	$\leq 5\%$	$\leq 5\%$	$\leq 5\%$
Protection against polarity reversal	Yes	Yes	Yes
Input current I_e	max. 1 A	max. 2.4 A	max. 3.3 A
Maximum heat dissipation (without local I/O)	8W	8W	8W
Galvanic separation from POW to			
System bus)	no	no	no
U_L supply voltage I/Q1...I/Q4	no	no	Yes
RS485 1)	no	no	Yes
CAN1 ¹⁾	–	no	Yes
CAN2 ¹⁾	–	–	no
Local inputs	–	no	Yes
Local outputs	–	no	Yes
ETH0...ETH2	Yes	Yes	Yes
Status indication POW	LED, single-colored, green	LED, single-colored, green	LED, single-colored, green
UBP_24 output voltage for the XN300 slice modules			
Output rated voltage	24 V DC	24 V DC	24 V DC
Output current	0.3 A	0.8 A	1.6 A
Short-circuit rating	no	no	Yes
Galvanic separation from POW	no	no	no
UBP_5 output voltage for the XN300 slice modules			
Output rated voltage	5 V DC	5 V DC	5 V DC
Output current	0.3 A	0.8A	1.6A
Short-circuit rating	Yes	Yes	Yes
Galvanic separation from POW	no	no	no

1) If provided

20.3.3 Power supply for local inputs/outputs on XC-204-..., XC-303-...

On XC-204-... devices, the local inputs and outputs are powered through the system power supply. On XC-303-... devices, the local inputs and outputs are powered through terminal X2/UL; this terminal is powered externally.

Power supply of local inputs/outputs	XC-204-...	XC-303-...
Rated operating voltage U_L	System supply	X2/ U_L
Rated value U_e	24 V DC	24 V DC
admissible range	19.2 - 30V DC	18 - 30V DC
Residual ripple	$\leq 5\%$	$\leq 5\%$
Protection against polarity reversal	–	Yes
Input current I_L	max. 1 A	max. 2 A
Galvanic separation U_L to		
System bus	no	Yes
POW	no	Yes
RS485	no	Yes
CAN1	no	Yes
CAN2	–	Yes
Local inputs	no	no
Local outputs	no	no
ETH0...ETH2	Yes	Yes
Flag Display	none	LED, single-colored, green

20.3.4 Local inputs XC-204-..., XC-303-...

Each of the transistor inputs can alternatively also be configured as an output.

Digital inputs (EN 61131-2, type 1)	XC-204-...	XC-303-...
Inputs (quantity)	2	4
Input rated voltage	24V DC, observe polarity	24V DC, observe polarity
Voltage levels	19,2...30V DC	18...30V DC
Input current per channel at rated operating voltage at 24 V	normally 2.5 mA	normally 2.5 mA
Switching levels as per EN 61131-2		
Limit values type "1"	low < 5, high > 15 V DC	low < 5, high > 15 V DC
Input delay		
Off → On	< 0.2ms	< 0.2ms
On → Off	< 0.2ms	< 0.2ms
of which the following can be used as interrupt inputs:	I1...I2	I1...I4
Galvanic separation from		
From each other	no	no
Local outputs	no	no
System bus	no	Yes
POW	no	Yes
RS485	no	Yes
CAN1	no	Yes
CAN2	–	Yes
ETH0...ETH2	Yes	Yes
Flag Display	LED, single-colored, green	LED, single-colored, green
Cable length (unscreened)	< 30m	< 30m

20 Appendix

20.3 Technical specifications

20.3.5 Local outputs XC-204-..., XC-303-...

Each of the transistor outputs can alternatively also be configured as an input. If the PLC is RESET, the outputs will be switched off.

Digital outputs	XC-204-...	XC-303-...
Channels (quantity)	2	4
Short-circuit proof	Yes	Yes
Isolation voltage	–	500 V AC
Heat dissipation per channel		
Q1 to Q4	<0.1W	<0.1W
Load circuits		
Q1 to Q4	0.5 A	0.5 A
Output delay		
Off → On	typ. 0.1 ms	typ. 0.1 ms
On → Off	typ. 0.1 ms ¹⁾	typ. 0.1 ms ¹⁾
Duty factor	100%	100%
Simultaneity factor g	1	1
Galvanic separation from		
From each other	no	no
from the inputs	no	no
System bus	no	Yes
POW	no	Yes
RS485	no	Yes
CAN1	no	Yes
CAN2	–	Yes
ETH0...ETH2	Yes	Yes
Flag Display	LED, two-colored, green, red	LED, single-colored, green
Cable length (unscreened)	< 30m	< 30m

1) without capacitive load

20.3.6 CAN interfaces XC-204-..., XC-303-...

The following devices feature CAN interfaces:

a CAN interface

- XC-204-C11-003
- XC-204-C21-001
- XC-303-C11-001
- XC-303-C21-001

two CAN interfaces

- XC-303-C32-002

CAN(open)	XC-204-...	XC-303-...
Baud rate CAN1, CAN2	50/100/125/250/500/1000kBits/s	50/100/125/250/500/1000kBits/s
Device profile	to DS301V4	to DS301V4
29 Bit Identifier	Yes	Yes
PDO type	asyn., cyc., acyc.	asyn., cyc., acyc.
Connection	3 pole plug connector, Push-In	3 pole plug connector, Push-In
Bus termination resistors for first and last CAN stations	120 Ω, switchable for CAN1 with dip switch TC	120 Ω, switchable for CAN1 with dip switch TC1 CAN2 with dip switch TC2
CANopen stations (number)	maximum 126/8	maximum 126/8
Galvanic separation from CAN1 to		
Supply voltage U _{Pow}	Yes	Yes
System bus	Yes	Yes
U _L supply voltage I/Q1...I/Q4	Yes	Yes
RS485	no	no
CAN2	–	Yes
Local inputs	Yes	Yes
Local outputs	Yes	Yes
ETH0...ETH2	Yes	Yes
Galvanic separation from CAN2 to		
Supply voltage U _{Pow}	–	no
System bus	–	no
U _L supply voltage I/Q1...I/Q4	–	Yes
RS485	–	Yes
CAN1	–	Yes
Local inputs	–	Yes
Local outputs	–	Yes

20 Appendix

20.3 Technical specifications

ETH0...ETH2	–	Yes
Flag Display	LED, two-colored, green, red	LED, two-colored, green, red
Connection cable	A shielded cable must be used for the interface. The shielding must be terminated on both sides externally.	A shielded cable must be used for the interface. The shielding must be terminated on both sides externally.

20.3.7 RS485-Interface

The following devices feature an RS-485 interface:

- XC-204-C11-003
- XC-204-C20-002
- XC-303-C21-001
- XC-303-C32-002

RS485-Interface	XC-204-...	XC-303-...
Terminal type	3 pole plug connector, Push-In	3 pole plug connector, Push-In
Transfer rate as		
Modbus RTU	1200, 2400, 4800, 9600, 19200, 38400, 57600, 115200 Bit/s	1200, 2400, 4800, 9600, 19200, 38400, 57600, 115200 Bit/s
serial interface	4800, 9600, 19200, 38400, 57600, 115200 Bit/s EVEN, ODD, and NONE parity is supported, as are 1 or 2 stop bits; in conformity with CODESYS serial adapter	4800, 9600, 19200, 38400, 57600, 115200 Bit/s EVEN, ODD, and NONE parity is supported, as are 1 or 2 stop bits; in conformity with CODESYS serial adapter
Bus termination resistors for first and last stations	120 Ω switchable; To activate, both the TRSa and TRSb DIP switches must be switched to the ON position	220 Ω switchable; To activate, both the TRSa and TRSb DIP switches must be switched to the ON position
Galvanic separation RS485 to		
Supply voltage U _{POW}	Yes	Yes
System bus	Yes	Yes
U _L supply voltage I/Q1...I/Q4	Yes	Yes
CAN1 ¹⁾	no	no
CAN2 ¹⁾	–	Yes
local inputs ¹⁾	Yes	Yes
local outputs ¹⁾	Yes	Yes
ETH0...ETH2	Yes	Yes
Flag Display	LED, multi-color, green, red	LED, multi-color, green, red
Connection cable	A shielded cable must be used for the interface. The shielding must be terminated on both sides externally.	A shielded cable must be used for the interface. The shielding must be terminated on both sides externally.

1) If provided

20.4 Glossary

POU	Programming organization unit A type POU object is a programming organization unit in a CODESYS project. In POU's schreiben Sie Quellcode für Ihr Steuerungsprogramm. You write source code in POU's for your control program.
Boot project	Project loaded from the CPU's non-volatile memory.
/home	Topmost file directory in the XControl PLC that a user with the "XC-303_user" status can access
Input delay	An input delay is the delay between a pulse edge from input terminals I1 to I4 and the CPU's GPIO.
OS	Operating system
MicroSD	Micro Secure Digital Card
Task	Process, task for operating system
Forcing	Setting by force, initializing changeable operands/tags with a fixed value
RTS	RunTimeSystem
PRG	Program
PLC	Programmable logic controller
RC	RemoteControl
IL Reference Listing	IL

Index

A

Address overlaps	84
Addressing	
Inputs/outputs and markers	84
Automatically generating a boot application during a download	66

B

Baud Rate	109
Boot application	
On microSD	67
On USB	67
Boot project	
Deleting, on SD/MMC	67
Deleting, on USB stick	68
Breakpoint	61

C

Cable protection	43
Cable routing	42
Cache memory	20
CAN	
Baud rate	28
Cable length	28
Interface,Assignment	27
Telegrams, receive/send from user program	29
CAN connection cable	28
Change PC's IP address	54
Commissioning	60
Connection	
Inputs/outputs	47, 48
Interrupt actuators	51
Connection set-up	92, 93, 99
Connection terminals	38
CPU	
Display of the operating states	60
Load	162
Cyclic task	74

D

Debugging	60, 157
Default IP addresses	24
Delete password	71, 142
Diagnostics	157
DIP switch	58
Discovery Service	53

Documentation, online	8
Download	9
Drives	20

E

EA_XC303Events	94
EDS file	
Installing	115, 123
update	115
Electromagnetic interference	31
Electronic data sheet	115
Ethernet	
Default IP addresses	24
Ethernet interface	23
EU5C-SWD-ETHERCAT	
Manual	117
Event controlled task	75

F

Factory reset	142
Factory reset via USB	141
Flag Display	61
Flash	20
Forcing	61
Function blocks	153
Functions	153
DisableInterrupt	94
EnableInterrupt	95
Read...Direct	83
Write...Direct	83

H

Help for browser commands	161
---------------------------	-----

I

InitPLC file	99
Inputs	
Addressing	84
Signal state	18
Wiring example	47, 48
Interface	
CANOpen,Configuration	27
ETH232, configuration	24
USB, configuration	23, 24
Interfaces	12
Interference factors	31

Interrupt	94	Power down logic	18
Actuator connection	51	Power supply	
Inputs	51	for processor unit and local inputs/outputs	18
Interrupt, CAN Bus	29	Power off/interruption (behavior)	60
L		Priority (task)	73
Layout of units	32	Program	
LED		Call (task)	74
PLC	60	Processing	73
PRG	60	Start	59
LED display	18	Stop	59
Library		Programming	12
Installation	153	Programming interface	24
Lighting protection	42	Programming software	
Limit values, for memory usage	83	Version	12
Loading the program	66	R	
M		Reactors	42
Manual	8	Real Time Clock (RTC)	19
Markers Addressing	84	Refreshing outputs during the simulation	59
Memory		Removing the XN300 slice modules	36
Systems	20	Reset	62
Usage, limit values	83	Reset to factory default values	142
Memory system		RS485 cable	26
disk_sd	20	S	
disk_usb	20	Screen earth kit	42
MMC memory card	20	Segments	83
Monitoring time, Task	79	Signal state inputs/outputs	18
Mounting instruction	8	Simulation, refreshing outputs	59
Mounting position	32	Single cycle mode	61
Mounting XC300	32	Single-step mode	61
Multi Media Card	19	Standards	
Multitasking	73, 77	IEC 60364	I
O		IEC 60364-4-41	I
Online documentation	8	IEC/EN 60204-1	I
Operating states CPU (LED display)	60	Startup behavior	56
Operating system		Status display in the front	63
Updating	68	Strip length	38
Outputs		Suppressor circuit for interference sources	42
Addressing	84	Switching threshold	18
Signal state	18	System	
Wiring example	47, 48	Events	73
P		Libraries	153
PC		Load, CPU	162
Change IP address	54	Memory	20
PLC Shell commands	157	-parameter predefined (in file InitPLC)	99
plcload	162	Times	73
Potential relationships	39	System block	32
		System events	76

T	
Task	
Condition	73
Configuration	73
Cyclic	74
Monitoring	79
Technical specifications	172
Test and startup	60
Type (task condition)	73

U	
USB Drive	22
USB interface activation	53, 141, 161
USB interface, assignment	23, 24
USB-Stick	19

V	
ventilation	31
Voltage dip	18

W	
Watchdog	79
Active	80
Configuration	80
Example	81
Monitoring tasks	79
Web Config Tool	
Logging off	138
Web configuration server	135
Factory reset	87, 142
Navigation	137
Network interfaces	143
Power management	142
Remote use	135
Setting up a password	135
Start page	138
System configuration	139
Web visualization	133
Wiring	42
Wiring example	
Inputs/outputs	47, 48

X	
XControl	
Device models	14
XControl web configuration server start page	87, 137
XML file	
Update	123
XN300	9

Eaton is an intelligent power management company dedicated to improving the quality of life and protecting the environment for people everywhere. We are guided by our commitment to do business right, to operate sustainably and to help our customers manage power – today and well into the future.

By capitalizing on the global growth trends of electrification and digitalization, we're accelerating the planet's transition to renewable energy, helping to solve the world's most urgent power management challenges, and doing what's best for our stakeholders and all of society.

Founded in 1911, Eaton has been listed on the NYSE for nearly a century.

We reported revenues of \$19.6 billion in 2021 and serve customers in more than 170 countries.

For more information, visit [Eaton.com](https://www.eaton.com). Follow us on [LinkedIn](https://www.linkedin.com/company/eaton).