

SL63031, SL63032, SL63033

IL01502087Z - 170930082

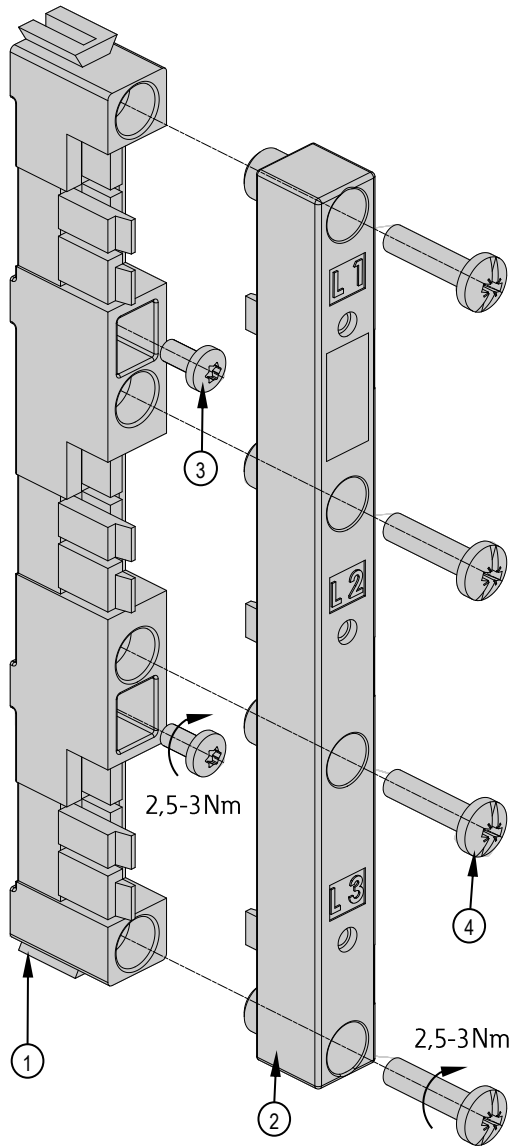

en Electric current! Danger to life!
Installation, commissioning and maintenance work must be carried out by qualified personnel only.

de Lebensgefahr durch elektrischen Strom!
Arbeiten bzw. Montage an diesem Produkt darf nur von Elektrofachkräften und elektrotechnisch unterwiesenen Personen ausgeführt werden.

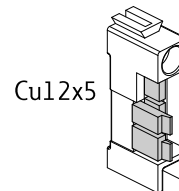

Cu12x5

SL63031

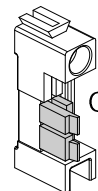

Cu2x12x5

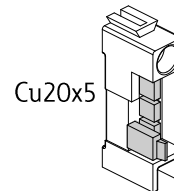

Cu20x5

SL63032

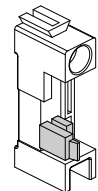

Cu20x10

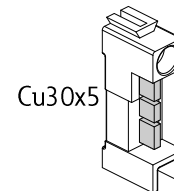

Cu30x5

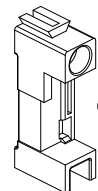

Cu30x10

SL63033

Bill of material

Art. No.	Name	No	Part	Qty.
		1		1
148582 148583 148584	SL63031 SL63032 SL63033	2		1
		3	M4x8	2
		4	5x20	4

