

DILM17-21 ... DILM32-21
XTCE018C21 ... XTCE032C21...
DILM17-32 ... DILM32-32
XTCE018C32 ... XTCE032C32...

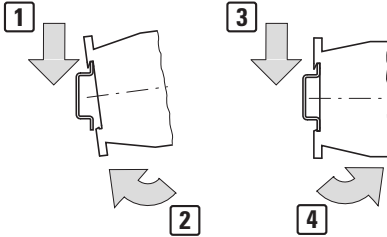
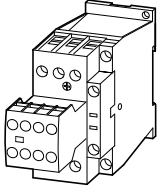

(en) **Electric current! Danger to life!**

Only skilled or instructed persons may carry out the following operations.

(de)

Lebensgefahr durch elektrischen Strom!

Nur Elektrofachkräfte und elektrotechnisch unterwiesene Personen dürfen die im Folgenden beschriebenen Arbeiten ausführen.

(fr)

Tension électrique dangereuse !

Seules les personnes qualifiées et averties doivent exécuter les travaux ci-après.

(es)

¡Corriente eléctrica! ¡Peligro de muerte!

El trabajo a continuación descrito debe ser realizado por personas cualificadas y advertidas.

(it)

Tensione elettrica: Pericolo di morte!

Solo persone abilitate e qualificate possono eseguire le operazioni di seguito riportate.

(zh)

触电危险!

只允许专业人员和受过专业训练的人员进行下列工作。

(ru)

Электрический ток! Опасно для жизни!

Только специалисты или проинструктированные лица могут выполнять следующие операции.

(ar)

تحذير! تيار كهربائي! خطر موت!
لا تتم أعمال الصيانة والتركيب إلا من قبل العاملين المدربين

Mounting

Dismounting

- 1 place in position
- 2 latch in



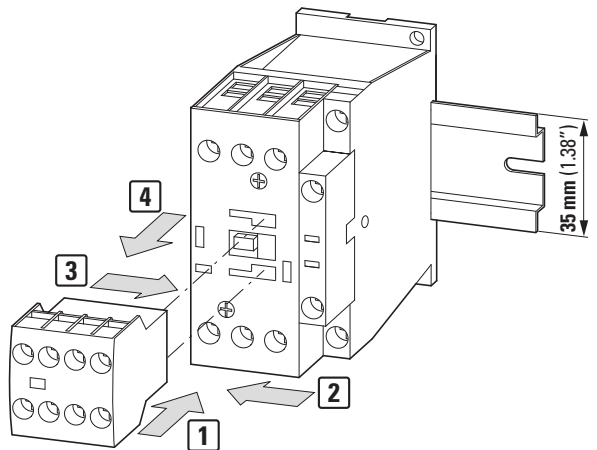

- 3 push
- 4 remove

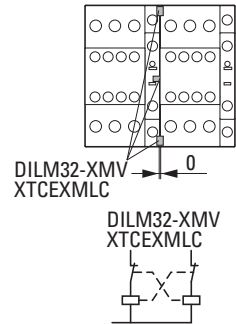
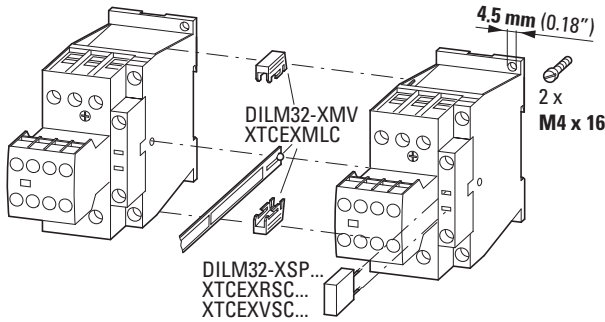
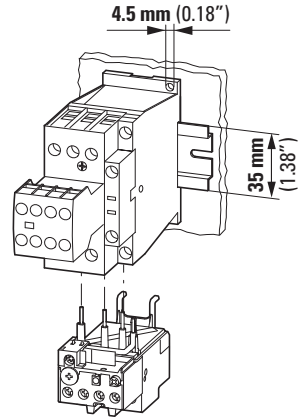
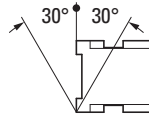
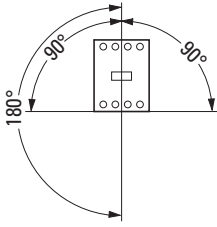







Mounting position

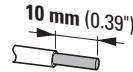
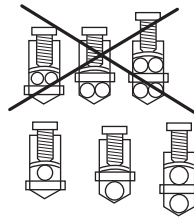

08/21 IL03407044Z

	mm ²	AWG	
	1 x (0.75 - 16)	1 x (18 - 6)	3.2 Nm (28 lb-in)
	2 x (0.75 - 10)	2 x (18 - 8)	
	1 x (0.75 - 16)		
	2 x (0.75 - 10)		
	1 x 16		



A1/A2 13/14 21/22 .../...	DILM XTCE	DIL...-XHI... XTCEX...	AWG	
	mm ²	mm ²		
	1 x (0.75 - 2.5)	1 x (0.75 - 2.5)	18 - 14	1.2 Nm (10.6 lb-in)
	2 x (0.75 - 2.5)	2 x (0.75 - 2.5)		
	1 x (0.75 - 2.5)	1 x (0.75 - 2.5)		
	2 x (0.75 - 2.5)	2 x (0.75 - 2.5)		
	1 x (0.75 - 2.5)	-		
	2 x (0.75 - 2.5)	-		

2/2

EU: Eaton Industries GmbH, Hein-Moeller-Straße 7-11,
53115 Bonn, Germany
UK: Eaton Electric Ltd., P.O. Box 554, Abbey Park,
Southampton Road, Titchfield, PO14 4QA, United Kingdom

© 2005 Eaton Industries GmbH

Eaton.com/contacts
Eaton.com/aftersales
Eaton.com/documentation
USA: Eaton.com/eatoncare

08/21 IL03407044Z



Eaton.com/recycling