

xEffect - Industrial Switchgear Range Residual Current Devices FRCdM









Catalog



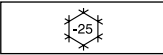

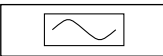

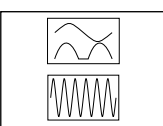

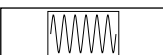
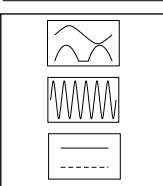
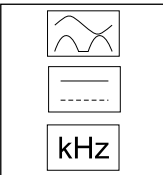
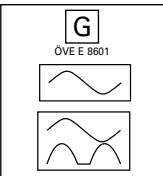
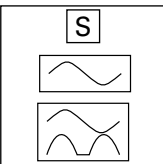

















Powering Business Worldwide

Residual Current Devices - General Data

Short description of the most important RCD types

Symbol	Description
	Eaton standard. Suitable for outdoor installation (distribution boxes for outdoor installation and building sites) up to -25° C.
	Conditionally surge-current proof (>250 A, 8/20 μs) for general application.
	Type AC: AC current sensitive RCCB
	Type A: AC and pulsating DC current sensitive RCCB, not affected by smooth DC fault currents up to 6 mA
	Type F: AC and pulsating DC current sensitive RCCB, trips also at frequency mixtures (10 Hz, 50 Hz, 1000 Hz), min. 10 ms time-delayed, min. 3 kA surge current proof, higher load capacity with smooth DC fault currents up to 10 mA
	Frequency range up to 20 kHz
	Trips also at frequency mixtures (10 Hz, 50 Hz, 1000 Hz)
	Type B: All-current sensitive RCD switchgear for applications where DC fault currents may occur. Non-selective, non-delayed. Protection against all kinds of fault currents.
	Type B+: All-current sensitive RCD switchgear for applications where DC fault currents may occur. Non-selective, non-delayed. Protection against all kinds of fault currents. Provides enhanced fire safety.
	RCD of type G (min 10 ms time delay) surge current-proof up to 3 kA. For system components where protection against unwanted tripping is needed to avoid personal injury and damage to property. Also for systems involving long lines with high capacitive reactance. Some versions are sensitive to pulsating DC. Some versions are available in all-current sensitive design.
	RCD of type S (selective, min 40 ms time delay) surge current-proof up to 5 kA. Mainly used as main switch, as well as in combination with surge arresters. This is the only RCD suitable for series connection with other types if the rated tripping current of the downstream RCD does not exceed one third of the rated tripping current of the device of type S. Some versions are sensitive to pulsating DC. Some versions are available in all-current sensitive design.

Kind of residual current and correct use of RCD Types

Kind of current	Current profile	Correct use / application field of RCCB types						Tripping current
		AC	A	F	B	/ B+		
Sinusoidal AC residual current								0.5 to 1.0 $I_{\Delta n}$
Pulsating DC residual current (positive or negative half-wave)		-						0.35 to 1.4 $I_{\Delta n}$
Cut half-wave current		-						Lead angle 90°: 0.25 to 1.4 $I_{\Delta n}$ Lead angle 135°: 0.11 to 1.4 $I_{\Delta n}$
Half-wave with smooth DC current of 6 mA		-						max. 1.4 $I_{\Delta n}$ + 6 mA
Half-wave with smooth DC current of 10 mA		-	-					max. 1.4 $I_{\Delta n}$ + 10 mA
Smooth DC current		-	-	-				0.5 to 2.0 $I_{\Delta n}$

Tripping time

Break time and non-actuating time for alternating residual currents (r.m.s. values) for type AC and A RCCB

Classification	$I_{\Delta n}$ mA		$I_{\Delta n}$	$2xI_{\Delta n}$	$5xI_{\Delta n}$	$5 x I_{\Delta n}$ or 0.25A	500A
Standard RCD Conditionally surge current-proof 250 A	≤30	Max. tripping time (s)	0.3	0.15		0.04	0.04
Standard RCD Conditionally surge current-proof 250 A	>30	Max. tripping time (s)	0.3	0.15	0.04		0.04
RCCB Type G (Short-time-delay) Surge current-proof 3 kA	30	Min. non actuating time(s) Max. tripping time (s)	0.01 0.3	0.01 0.15		0.01 0.04	0.01 0.04
RCCB Type G (Short-time-delay) Surge current-proof 3 kA	>30	Min. non actuating time(s) Max. tripping time (s)	0.01 0.3	0.01 0.15	0.01 0.04		0.01 0.04
RCCB Type S (Selective) Surge current-proof 5 kA	>30	Min. non actuating time(s) Max. tripping time (s)	0.13 0.5	0.06 0.2	0.05 0.15		0.04 0.15

Break time for half-wave pulsating residual currents (r.m.s. values) for type A RCCB

Classification	$I_{\Delta n}$ mA		$1.4xI_{\Delta n}$	$2xI_{\Delta n}$	$2.8xI_{\Delta n}$	$4xI_{\Delta n}$	$7 x I_{\Delta n}$	0.35 A	0.5 A	350A
Standard RCD Conditionally surge current-proof 250 A	<30	Max. tripping time (s)		0.3		0.15			0.04	0.04
Standard RCD Conditionally surge current-proof 250 A	30	Max. tripping time (s)	0.3		0.15			0.04		0.04
Standard RCD Conditionally surge current-proof 250 A	>30	Max. tripping time (s)	0.3		0.15		0.04			0.04
RCCB Type G (Short-time-delay) Surge current-proof 3 kA	30	Max. tripping time (s)	0.3		0.15			0.04		0.04
RCCB Type G (Short-time-delay) Surge current-proof 3 kA	>30	Max. tripping time (s)	0.3		0.15		0.04			0.04
RCCB Type S (Selective) Surge current-proof 5 kA	>30	Max. tripping time (s)	0.5		0.2		0.15			0.15

Tripping Characteristics (IEC/EN 61008)

Tripping characteristics, tripping time range and selectivity of instantaneous, surge current-proof „G“ and surge current-proof - selective „S“ residual current devices.

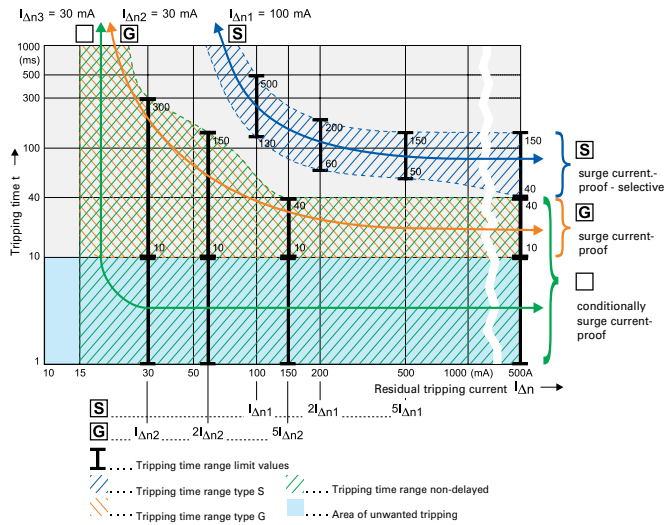

IEC 60364-4-41 deals with additional protection: The use of RCDs with a rated residual operating current not exceeding 30 mA, is recognized in a.c. systems as additional protection in the event of failure of the provision for basic protection and/or the provision for fault protection or carelessness by users.

This means when using RCDs for fault current/residual current protection two RCDs must be connected in series.

Testing:

RCDs with tripping time delay (Types -G and -S) may be function tested with conventional testing equipment which must be set according to the instructions for operation of the testing device. Due to reasons inherent in the measuring process, the tripping time determined in this way may be longer than expected in accordance with the specifications of the manufacturer of the measuring instrument.

However, the device is ok if the result of measurement is within the time range specified by the manufacturer of the measuring instrument.

Applications with frequency converters:

Due to the currents flowing off through the filters (designated IF), the sum of currents through the RCD is not exactly zero, which causes unwanted tripping.

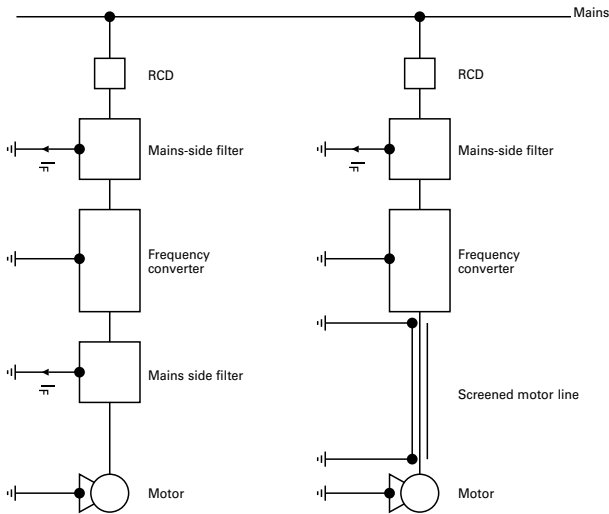

Frequency converters are used in a wide variety of systems and equipment requiring variable speed, such as lifts, escalators, conveyor belts, and large washing machines. Using them for such purposes in circuits with conventional residual current devices causes frequent problems with unwanted tripping.

The technical root cause of this phenomenon is the following: Fast switching operations involving high voltages cause high interference levels which propagate through the lines on the one hand, and in the form of interfering radiation on the other. In order to eliminate this problem, a mains-side filter (also referred to as input filter or EMC-filter) is connected between the RCD and frequency converter. The anti-interference capacitors in the filters produce discharge currents against earth which may cause unwanted tripping of the RCD due to the apparent residual currents. Connecting a filter on the output side between frequency converter and 3-phase AC motor results in the same behaviour.

Tripping characteristic

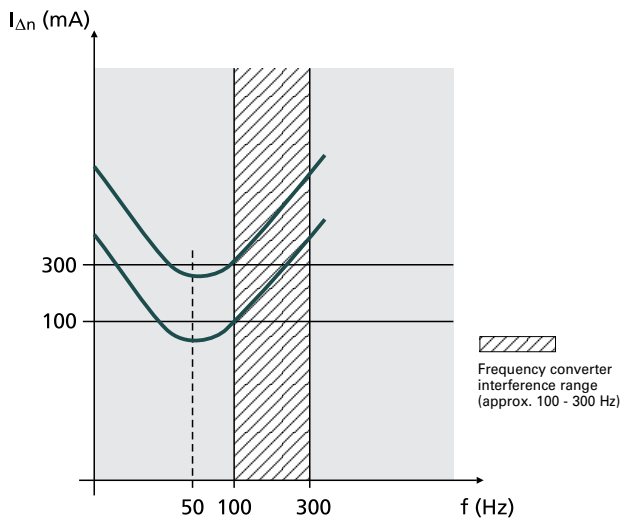

This sample tripping characteristic of a 100 mA RCD and a 300 mA RCD shows the following: In the frequency range around 50 Hz, the RCDs trip as required (50 - 100 % of the indicated $I_{\Delta n}$).

In the range shown hatched in the diagram, i. e. from approx. 100 to 300 Hz, unwanted tripping occurs frequently due to the use of frequency converters. Type F RCCBs are designed to reliably sense higher frequency residual currents, which leads to an enormous increase in the reliability and availability of electrical systems.

Therefore, we recommend to use RCDs designed for applications with frequency converter!

These special residual current devices can be recognised by an extension of the type designation („-F“). They meet the requirements of compatibility between RCDs and frequency converters with respect to unwanted tripping.

Eaton stands for highest availability of your system also in applications where frequency drives are used. Therefore a full suite of Type F RCCBs (mechanical and digital assisted) are available in all feasible ratings to assist you in your application needs.

Our RCDs of type „-F“ are characterized by:

- Improved capabilities of reliably sensing residual currents up to 1 kHz
- Improved capabilities of withstanding 10 mA DC offset
- 10 ms short time delay minimum (G/F)
- Surge current proofness of 3 kA (G/F) and 5 kA (S/F)

wa_sg08020_1



Description

- Line voltage independent RCCB for fault protection, additional protection as well as fire protection
- Additional digital functionality for improved system availability as well as system monitoring
- Live status of the system communicated through an integrated auxiliary contact as well as on the device itself
- Digital assisted sensing of residual current to achieve highest levels of system availability
- FRCdM reduces running costs due to a yearly test interval
- Fault current tripping indicator enables to determine the tripping reason
- Comprehensive accessories available
- Suitable to be put into rail rolling stock applications due to additional certification

$I_n/I_{\Delta n}$ (A)	Type Designation	Article No.	Units per package
---------------------------	---------------------	-------------	----------------------

Type G/A

Surge current-proof 3 kA, sensitive to residual pulsating DC, Type G/A (ÖVE E 8601) 

4-poles

25/0.03	FRCdM-25/4/003-G/A	168646	1/30
25/0.1	FRCdM-25/4/01-G/A	501257	1/30
25/0.3	FRCdM-25/4/03-G/A	168647	1/30
40/0.03	FRCdM-40/4/003-G/A	168648	1/30
40/0.1	FRCdM-63/4/01-G/A	501261	1/30
40/0.3	FRCdM-40/4/03-G/A	168649	1/30
63/0.03	FRCdM-63/4/003-G/A	168650	1/30
63/0.1	FRCdM-63/4/01-G/A	501268	1/30
63/0.3	FRCdM-63/4/03-G/A	168651	1/30
80/0.03	FRCdM-80/4/003-G/A	168634	1/30
80/0.1	FRCdM-80/4/01-G/A	501275	1/30
80/0.3	FRCdM-80/4/03-G/A	168635	1/30

wa_sg08020_1



Type S/A

Selective + surge current-proof typ. 5 kA, sensitive to residual pulsating DC, Type S/A 

4-poles

40/0.1	FRCdM-40/4/01-S/A	501263	1/30
40/0.3	FRCdM-40/4/03-S/A	168637	1/30
63/0.1	FRCdM-63/4/01-S/A	501270	1/30
63/0.3	FRCdM-63/4/03-S/A	168638	1/30
80/0.1	FRCdM-80/4/01-S/A	501277	1/30
80/0.3	FRCdM-80/4/03-S/A	168639	1/30

wa_sg07020_1



$I_n/I_{\Delta n}$ (A)	Type Designation	Article No.	Units per package
---------------------------	---------------------	-------------	----------------------

Type G/F

Surge current-proof 3 kA, sensitive to residual pulsating DC, frequency mixture and 10 mA DC offset, Type G/F (ÖVE E 8601)  



wa_sg08020_1



4-poles

25/0.03	FRCdM-25/4/003-G/F	501256	1/30
25/0.1	FRCdM-25/4/01-G/F	501258	1/30
25/0.3	FRCdM-25/4/03-G/F	501259	1/30
40/0.03	FRCdM-40/4/003-G/F	501260	1/30
40/0.1	FRCdM-63/4/01-G/F	501262	1/30
40/0.3	FRCdM-40/4/03-G/F	501265	1/30
63/0.03	FRCdM-63/4/003-G/F	501267	1/30
63/0.1	FRCdM-63/4/01-G/F	501269	1/30
63/0.3	FRCdM-63/4/03-G/F	501272	1/30
80/0.03	FRCdM-80/4/003-G/F	501274	1/30
80/0.1	FRCdM-80/4/01-G/F	501276	1/30
80/0.3	FRCdM-80/4/03-G/F	501279	1/30

Type S/F

Selective current-proof 5 kA, selective, sensitive to residual pulsating DC, frequency mixture and 10 mA DC offset, Type S/F (ÖVE E 8601)  

wa_sg07020_1



4-poles

40/0.1	FRCdM-40/4/01-S/F	501264	1/30
40/0.3	FRCdM-40/4/03-S/F	501266	1/30
63/0.1	FRCdM-63/4/01-S/F	501271	1/30
63/0.3	FRCdM-63/4/03-S/F	501273	1/30
80/0.1	FRCdM-80/4/01-S/F	501278	1/30
80/0.3	FRCdM-80/4/03-S/F	501280	1/30

Type R PHASE OUT

Surge current-proof 3 kA, X-ray application, Type R 

wa_sg06920_1



4-poles

63/0.03	FRCdM-63/4/003-R	168636	1/30
---------	------------------	--------	------

Specifications | Residual Current Devices FRCdM

Description

Design

- Digital Residual Current Circuit Breakers (RCCBs)
- Designed and suitable to be put into an xEffect-System
- Twin-purpose terminal (lift/open-mouthed) above and below
- Contact position indicator red - green
- Tripping indicator white - blue
- Additional safety due:
 - possibility to seal the toggle
 - possibility to lock the toggle
- The device functions irrespective of the position of installation

Accessories

- Busbar positioning optionally above or below
- Free terminal space despite installed busbar
- Auxiliary contacts to be mounted onto the device:
 - Universal tripping signal switch, also suitable for FAZ, FRBmM-1N
 - Auxiliary switch Z-HK can be mounted subsequently

Additional information for the application

- Delayed types suitable for being used with standard fluorescent tubes with or without electronical ballast
 - 30mA-RCCBs: 30 units per phase conductor
 - 100mA RCCBs: 90 units per phase conductor

Note: Depending on the fluorescent lamp manufacturer, partly more units possible. Symmetrical allocation of the fluorescent lamp ballasts on all phases favorably. Please still consider the technical data provided by the manufacturer of the lamps.
- Tripping is line voltage independent (VI) and therefore suitable for all BA-classes.

The RCD is suitable for fault protection, additional protection, fire protection within the regulations of the applicable wiring regulations (e.g.: IEC/EN 60364)
- Independent supply side except applications according to connection diagram (2)
- The 4-pole device can also be used for 3-pole and 2 pole applications. Please refer to published connection diagrams

Test Button

- The test button "T" must be pressed once every 12 months. The system operator must be informed of this obligation and his responsibility in a way that can be proven.

Under special conditions (e.g.: dampy and/or dusty environments, environments with polluting and/or corroding conditions, environments with large temperature fluctuations, installations with a risk of overvoltage due to switching of equipment and/or atmospheric discharges, portable equipment, ...), it's recommended to test in monthly intervals. Regulations according IEC/EN 60364 or wiring regulations still apply.

If red and yellow LED are present simultaneously, please press the test button and follow the instruction stated in the instruction leaflet.
- The test button "T" tests the function of the RCCB itself. This test does not measure a "suitable" fault loop or if requirements of such are kept. Testing your fault loop (earth rod resistance, continuity of fault loop,...) requires special tests performed separately.

Status Indication of digital RCCB





- System status as seen on the RCCB:
 - The green LED becomes active at 0-30% $I_{\Delta n}$
 - The yellow LED becomes active at 30-50% $I_{\Delta n}$, as well as the integrated auxiliary contact
 - The red LED becomes active at >50% $I_{\Delta n}$
 - Tolerance of system status indication: $\pm 5\%$

- The internal potential-free auxiliary contact (NO, terminals 13/14) for external communication is actuated starting at 30 $I_{\Delta n}$. The contact will stay "active" even after the breaker trips

The integrated auxiliary contact provides basic insulation from the main terminals of the RCCB. Without any additional protective measures (eg.: isolation transformer 1:1 according to IEC/EN 60664) the integrated auxiliary contact may only be supplied from the terminals 2, 4, 6, N. See also connection diagrams (2) and (3) for further details

- **Type A:** These types are capable of sensing pulsating residual currents and are not negatively affected by a DC overlay of up to 6mA. These devices (depend on the range) are also available as:
 - G/A short time delayed devices which are surge current proof up to 3kA. These devices enable a reliable and safe installation with increased system availability
 - S/A selective RCCBs with improved surge current capabilities up to 5kA. These devices are selective (conditions apply) to other RCDs and enable special applications and root installations.
- **Type F:** These types are capable of sensing pulsating residual currents, residual currents up to 1kHz and are not negatively affected by a DC overlay of up to 10mA. They also offer improved availability of your system. These devices (depend on the range) are also available as:
 - G/F short time delayed devices which are surge current proof up to 3kA. These devices enable a reliable and safe installation with increased system availability
 - S/F selective RCCBs with improved surge current capabilities up to 5kA. These devices are selective (conditions apply) to other RCDs and enable special applications and root installations.
- **Type G:** G Types offer a 10ms time delayed tripping curve and surge current proof capabilities up to 3kA and are highly recommended to be used for applications and installations where system availability is an important factor. Since "G" states a tripping curve and not a sensitivity, these devices (depend on the range) will be found as
 - AC sensitive devices (-G)
 - A Type RCCBs (-G/A)
 - F Type RCCBs (-G/F)
 - B/Bfq/B+ Type RCCBs (-G/B(fq/+))
- **Type S:** S Types offer a 40ms time delayed tripping curve and surge current proof capabilities up to 5kA and are known as "selective" types. These devices are mainly used in root applications with additional RCDs deployed in series in the system. Since "S" states a tripping curve and not a sensitivity, these devices (depend on the range) will be found as:
 - AC sensitive devices (-S)
 - A Type RCCBs (-S/A)
 - F Type RCCBs (-S/F)
 - B/Bfq/B+ Type RCCBs (-S/B(fq/+))

Local status indication provided by the digital RCCB

LED signals		red / yellow / green
Permanent light green		Normal operation
Permanent light yellow		The currently measured residual current is higher than 30% I _{Δn} . The system is currently drawing a fault current, and actions should be taken accordingly.
Permanent light red		The currently measured residual current is higher than 50% I _{Δn} . The system is currently drawing a critical amount of fault current, and actions should be taken immediately.
Flashing yellow/red		Please press the test button (T). If the LEDs are still present, please refer to the instruction leaflet.

Remotely communicated status indication provided by the digital RCCB

Integrated contact for use in control circuits. Please adhere to the electrical limits of the NO contacts (0,25A ohmic load @ 240V). Without any additional protective measures (eg.: isolation transformer 1:1 according to IEC/EN 60664) the integrated auxiliary contact may only be supplied from the terminals 2, 4, 6, N. See also connection diagrams (2) and (3) for further details.

Accessories:

Auxiliary contact to be mounted on the left side	Z-HK	248432
Auxiliary contact to be mounted on the right side	Z-NHK	248434
Automatic restarting device	Z-FW/LP	248296
	Z-FW-LPD	265244
	Z-FW-MO	284730
	Z-FW-LP/MO	290171
	Z-FW-LPD/MO	290172
I _{Δn} testing module	Z-FW/003	248298
	Z-FW/010	248299
	Z-FW/030	248300
Terminal cover 4-poles	Z-RC/AK-4TE	101062

Technical Data

		FRCdM
Electrical		
Design according to		IEC/EN 61008 Type G (G/A, G/F,...) acc. to ÖVE 8601 Type F acc. to IEC/EN 62423
Classified according to		IEC 61373, EN 45545-2
Current test marks as printed onto the device		
Tripping		instantaneous
Type G , R		10 ms delay
Type S		40 ms delay - with selective disconnecting function
Rated voltage	U_n	240/415 V AC, 50/60 Hz
Limits of operation voltage digital functions		50 – 264V AC
Limits of operation voltage test circuit		
Rated tripping current	$I_{\Delta n}$	30, 100, 300 mA
Sensitivity		AC and pulsating DC
Rated insulation voltage	U_i	440 V
Rated impulse withstand voltage	U_{imp}	4 kV (1.2/50 μ s)
Rated short circuit capacity	I_{cn}	10 kA with back-up fuse
Peak withstand current		
Type G (G/A, G/F)		3 kA (8/20 μ s) surge current-proof
Type S (S/A, S/F)		5 kA (8/20 μ s) selective + surge current-proof
Rated breaking capacity or rated fault breaking capacity	I_m $I_{\Delta m}$	
$I_n = 25-40$ A		500 A
$I_n = 63$ A		630 A
$I_n = 80$ A		800 A
Endurance		
electrical components		$\geq 4,000$ operating cycles
mechanical components		$\geq 20,000$ operating cycles
Mechanical		
Frame size		45 mm
Device height		80 mm
Device width		70 mm (4MU)
Mounting		quick fastening with 2 lock-in positions on DIN rail IEC/EN 60715
Degree of protection, built-in		IP40
Degree of protection in moisture-proof enclosure		IP54
Upper and lower terminals		open mouthed/lift terminals
Terminal protection		finger and hand touch safe, DGUV VS3, EN 50274
Terminal capacity		1.5 - 35 mm ² single wire 2 x 16 mm ² multi wire
Terminal screw		M5 (with slotted screw acc. to EN ISO 4757-Z2, Pozidriv PZ2)
Terminal torque		2 - 2.4 Nm
Busbar thickness		0.8 - 2 mm
Operation temperature		-25°C to +40°C (for higher values see table on ambient temperature)
Storage- and transport temperature		-35°C to +60°C
Resistance to climatic conditions		acc. to IEC/EN 61008
Contact position indicator		red / green
Tripping indicator		white / blue
Internal contact		
Rated breaking capacity @ 30 V DC (resistive load)		2 A
Rated breaking capacity @ 240 V AC (resistive load)		0.25 A
Maximum switching power (resistive load)		60 W
Maximum switching voltage DC		220 V
Maximum switching voltage AC		240 V
Maximum switching current		2 A
Minimum switching capacity (reference value)		10 μ A, 10 mV DC
Endurance		
Electrical (at 20 cpm) 2 A 30 V DC resistive load)		$>10^5$
Electrical (at 20 cpm) 1 A 30 V DC resistive load)		$>5 \times 10^5$
Terminal capacity		0.25 - 1.5 mm ²

Connection diagram

4-poles

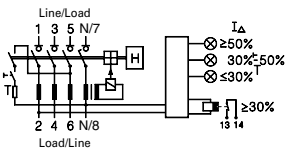

① Without use of auxiliary contact line/load side free selectable

4-poles

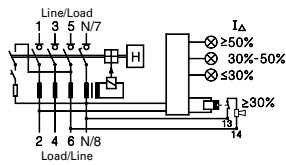

② Signalisation without Isolation Transformer 1:1 (IEC/EN 60664)

4-poles

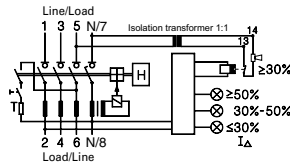

③ Signalisation with Isolation Transformer 1:1 (IEC/EN 60664)

Dimensions (mm)

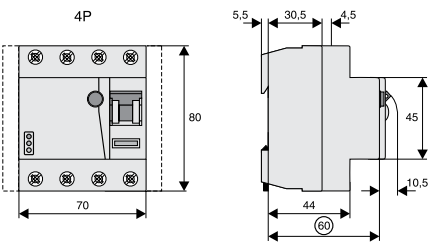

Correct connection

30, 300mA Types:

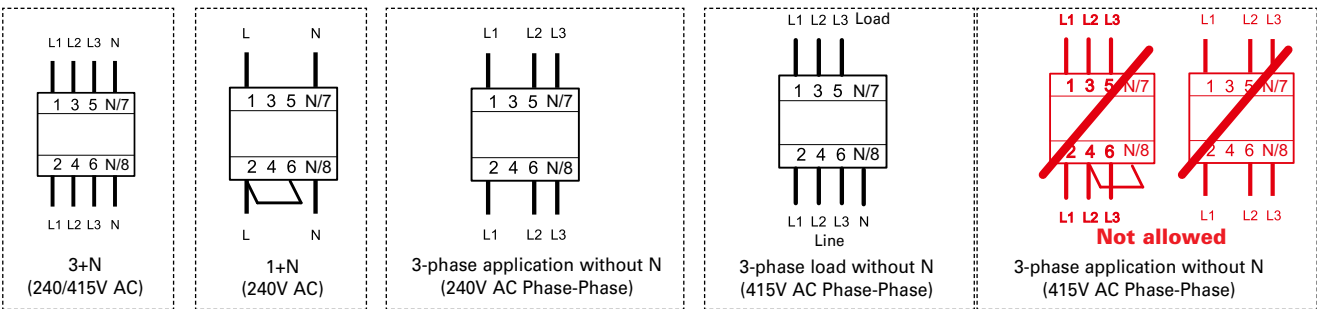

Electronic works within 50-264V AC!

- Disconnect load side of the switch gear, if you make a insulation test of the installation!

Internal Resistance FRCdM

At room temperature (single pole)

In [A]	Z* [mΩ]
25	0.66
40	0.64
63	0.64
80	0.62

* 50Hz

Power Loss at In FRCdM

(entire unit)

In [A]	P* [W]
25	2.2
40	3.8
63	8.5
80	12.9

* 50Hz

Impact of ambient temperature on the maximum permanent current allowed (A) FRCdM type A and F

Ambient temperature	25A	40A	63A	80A
	4p	4p	4p	4p
40°	25	40	63	80
45°	25	35	55	71
50°	25	30	47	63
55°	23	28	38	54
60°	20	25	30	45
65°	-	-	-	-
70°	-	-	-	-
75°	-	-	-	-

Note: Please make sure that these values are not exceeded and that any upstream thermal overload protection switches off in time.

Max. back-up fuse FRCDM

Rating In [A]	Fuses		MCB's (Characteristic B/C)	
	Short Circuit [A]	Overload [A]	Short Circuit [A]	Overload [A]
25	63 gG/gI	25 gG/gI	FAZ-C40	FAZ-C25
40	63 gG/gI	40 gG/gI	FAZ-C40	FAZ-C40
63	63 gG/gI	63 gG/gI	FAZ-C40	FAZ-C40
80	80 gG/gI	80 gG/gI	-	-

Important:

In the case that the maximal possible operating current of the electrical installation don't exceed the rated current of the RCD only short circuit protection must be implemented. Overload protection must be implemented in the case if the maximal possible operating current of the electrical installation can exceed the rated current of the RCD.

wa_sg04320_1





Description

- All current sensitive RCCBs to fulfil highest safety standards
- Line voltage independent 2 and 4 pole RCCB for fault protection, additional protection as well as fire protection
- As also stated in IEC/EN 62423, the B sensitivity relies on line voltage
- Additional digital functionality for improved system availability as well as system monitoring
- Live status of the system communicated through an integrated auxiliary contact as well as on the device itself
- Digital assisted sensing of residual current to achieve highest levels of system availability
- FRCdM reduce running costs due to a yearly test interval
- Fault current tripping indicator enables to determine the tripping reason
- Comprehensive accessories available
- Suitable to be put into rail rolling stock applications due to additional certification
- B+ types also meet the requirements of superior fire-protection systems according to VDE 0664-400

$I_n/I_{\Delta n}$ (A)	Operating frequency (Hz)	Type Designation	Article No.	Units per package
---------------------------	-----------------------------	---------------------	-------------	----------------------

Type G/B

Surge current-proof 3 kA, AC-DC sensitive, Type G/B (ÖVE E 8601)   

2-Pole (4MU)

25/0.03	50	FRCdM-25/2/003-G/B	300638	1/30
25/0.3	50/60	FRCdM-25/2/03-G/B	302638	1/30
40/0.03	50	FRCdM-40/2/003-G/B	300639	1/30
40/0.3	50/60	FRCdM-40/2/03-G/B	302639	1/30
63/0.03	50	FRCdM-63/2/003-G/B	300640	1/30
63/0.3	50/60	FRCdM-63/2/03-G/B	302640	1/30

wa_sg10420_1





wa_sg05320_1



4-poles

25/0.03	50	FRCdM-25/4/003-G/B	167892	1/30
25/0.3	50/60	FRCdM-25/4/03-G/B	167896	1/30
40/0.03	50	FRCdM-40/4/003-G/B	167893	1/30
40/0.3	50/60	FRCdM-40/4/03-G/B	167897	1/30
63/0.03	50	FRCdM-63/4/003-G/B	167894	1/30
63/0.3	50/60	FRCdM-63/4/03-G/B	167898	1/30

Type S/B

Selective + surge current-proof 5 kA, Type S/B   

2-Pole (4MU)

25/0.3	50	FRCdM-25/2/03-S/B	302635	1/30
40/0.3	50	FRCdM-40/2/03-S/B	302636	1/30
63/0.3	50	FRCdM-63/2/03-S/B	302637	1/30

wa_sg11620_1



4-poles

25/0.3	50	FRCdM-25/4/03-S/B	167900	1/30
40/0.3	50	FRCdM-40/4/03-S/B	167901	1/30
63/0.3	50	FRCdM-63/4/03-S/B	167902	1/30

wa_sg05920_1



Type G/Bfq

Surge current-proof 3 kA, AC-DC sensitive, Type G/Bfq (ÖVE E 8601)   

4-poles



25/0.03	50	FRCdM-25/4/003-G/Bfq	179530	1/30
25/0.03	50	FRCdM-25/4/003-G/Bfq-400	306415	1/30
25/0.3	50/60	FRCdM-25/4/03-G/Bfq	167904	1/30
40/0.03	50	FRCdM-40/4/003-G/Bfq	179531	1/30
40/0.03	50	FRCdM-40/4/003-G/Bfq-400	306418	1/30
40/0.3	50/60	FRCdM-40/4/03-G/Bfq	167905	1/30
63/0.03	50	FRCdM-63/4/003-G/Bfq	179532	1/30
63/0.03	50	FRCdM-63/4/003-G/Bfq-400	306421	1/30
63/0.3	50/60	FRCdM-63/4/03-G/Bfq	167906	1/30

wa_sg09220_1



$I_n/\Delta n$ (A)	Operating frequency (Hz)	Type Designation	Article No.	Units per package
-----------------------	-----------------------------	---------------------	-------------	----------------------

Type S/Bfq

Selective + surge current-proof 5 kA, Type S/Bfq   

4-poles

25/0.3	50	FRCdM-25/4/03-S/Bfq	167908	1/30
40/0.3	50	FRCdM-40/4/03-S/Bfq	167909	1/30
63/0.3	50	FRCdM-63/4/03-S/Bfq	167910	1/30

wa_sg06520_1



Type G/B+

Surge current-proof 3 kA, Type G/B+ (ÖVE E 8601)   kHz



4-poles

25/0.03	50	FRCdM-25/4/003-G/B+	167880	1/30
25/0.03	50	FRCdM-25/4/003-G/B+-400	306422	1/30
25/0.3	50/60	FRCdM-25/4/03-G/B+	167884	1/30
40/0.03	50	FRCdM-40/4/003-G/B+	167881	1/30
40/0.03	50	FRCdM-40/4/003-G/B+-400	306423	1/30
40/0.3	50/60	FRCdM-40/4/03-G/B+	167885	1/30
63/0.03	50	FRCdM-63/4/003-G/B+	167882	1/30
63/0.03	50	FRCdM-63/4/003-G/B+-400	306424	1/30
63/0.3	50/60	FRCdM-63/4/03-G/B+	167886	1/30

wa_sg04420_1



Type S/B+

Selective + surge current-proof 5 kA, Type S/B+   kHz

4-poles



25/0.3	50	FRCdM-25/4/03-S/B+	167888	1/30
40/0.3	50	FRCdM-40/4/03-S/B+	167889	1/30
63/0.3	50	FRCdM-63/4/03-S/B+	167890	1/30

wa_sg05020_1



$I_n/I_{\Delta n}$ (A)	Operating frequency (Hz)	Type Designation	Article No.	Units per package
---------------------------	-----------------------------	---------------------	-------------	----------------------

Type G/B

Surge current-proof 3 kA, AC-DC sensitive, Type G/B (ÖVE E 8601)   

4-poles

25/0.03	60	FRCdM-25/4/003-G/B/60Hz	180418	1/30
40/0.03	60	FRCdM-40/4/003-G/B/60Hz	180421	1/30
63/0.03	60	FRCdM-63/4/003-G/B/60Hz	180424	1/30

wa_sg09720_1



Type G/Bfq

Surge current-proof 3 kA, AC-DC sensitive, Type G/Bfq (ÖVE E 8601)   

4-poles

25/0.03	60	FRCdM-25/4/003-G/Bfq/60Hz	180420	1/30
40/0.03	60	FRCdM-40/4/003-G/Bfq/60Hz	180423	1/30
63/0.03	60	FRCdM-63/4/003-G/Bfq/60Hz	180426	1/30

wa_sg09920_1



Type G/B+

Surge current-proof 3 kA, Type G/B+ (ÖVE E 8601)   kHz

4-poles

25/0.03	60	FRCdM-25/4/003-G/B+/60Hz	180419	1/30
25/0.3	50/60	FRCdM-25/4/03-G/B+	167884	1/30
40/0.03	60	FRCdM-40/4/003-G/B+/60Hz	180422	1/30
40/0.3	50/60	FRCdM-40/4/03-G/B+	167885	1/30
63/0.03	60	FRCdM-63/4/003-G/B+/60Hz	180425	1/30
63/0.3	50/60	FRCdM-63/4/03-G/B+	167886	1/30

wa_sg04720_1



Specifications | Residual Current Devices FRCdM - digital, Type B, Bfq and B+

Description

Design

- Digital Residual Current Circuit Breakers (RCCBs)
- Designed and suitable to be put into an xEffect-System
- Twin-purpose terminal (lift/open-mouthed) above and below
- Contact position indicator red - green
- Tripping indicator white - blue
- Additional safety due:
 - possibility to seal the toggle
 - possibility to lock the toggle
- The device functions irrespective of the position of installation

Accessories

- Busbar positioning optionally above or below. (Please adhere to the supply side of the RCCB)
- Free terminal space despite installed busbar
- Auxiliary contacts to be mounted onto the device:
 - Universal tripping signal switch, also suitable for FAZ, FRBmM-1N
 - Auxiliary switch Z-HK can be mounted subsequently

Additional information for the application

- Delayed types suitable for being used with standard fluorescent tubes with or without electronical ballast
 - 30mA-RCCBs: 30 units per phase conductor
 - 100mA RCCBs: 90 units per phase conductor

Note: Depending on the fluorescent lamp manufacturer, partly more units possible. Symmetrical allocation of the fluorescent lamp ballasts on all phases favorably. Please still consider the technical data provided by the manufacturer of the lamps.
- Tripping is line voltage independent (VI) and therefore suitable for all BA-classes.

The RCD is suitable for fault protection, additional protection, fire protection within the regulations of the applicable wiring regulations (e.g.: IEC/EN 60364)
- Independent supply side except applications according to connection diagram (2))
- The 4-pole device can also be used for 3-pole and 2 pole applications. Please refer to published connection diagrams

Test Button

- The test button "T" must be pressed once every 12 months. The system operator must be informed of this obligation and his responsibility in a way that can be proven.

Under special conditions (e.g.: damply and/or dusty environments, environments with polluting and/or corroding conditions, environments with large temperature fluctuations, installations with a risk of overvoltage due to switching of equipment and/or atmospheric discharges, portable equipment, ...), it's recommended to test in monthly intervals. Regulations according IEC/EN 60364 or wiring regulations still apply.

If red and yellow LED are present simultaneously, please press the test button and follow the instruction stated in the instruction leaflet.
- The test button "T" tests the function of the RCCB itself. This test does not measure a "suitable" fault loop or if requirements of such are kept. Testing your fault loop (earth rod resistance, continuity of fault loop,...) requires special tests performed separately.

Status Indication of digital RCCB

- System status as seen on the RCCB:
 - The green LED becomes active at 0-30% $I_{\Delta n}$
 - The yellow LED becomes active at 30-50% $I_{\Delta n}$, as well as the integrated auxiliary contact
 - The red LED becomes active at >50% $I_{\Delta n}$
 - Tolerance of system status indication: $\pm 5\%$

- The internal potential-free auxiliary contact (NO, terminals 13/14) for external communication is actuated starting at 30 $I_{\Delta n}$. The contact will stay "active" even after the breaker trips





The integrated auxiliary contact provides basic insulation from the main terminals of the RCCB. Without any additional protective measures (eg.: isolation transformer 1:1 according to IEC/EN 60664) the integrated auxiliary contact may only be supplied from the terminals 2, 4, 6, N. See also connection diagrams (2) and (3) for further details.

- **Type B (fq, +):** These types offer the highest safety levels in electrical systems due to their all-current sensitivity and best in class reliability and system availability. Special type B from Eaton are available:
 - B+ limit the possibility of electrical ignited fires and should be considered for fire hazard applications as also mentioned in VDE-0664-400
 - Bfq are capable of reliably sensing residual currents up to 50 kHz
- **Type G:** G Types offer a 10 ms time delayed tripping curve and surge current proof capabilities up to 3 kA and are highly recommended to be used for applications and installations where system availability is an important factor. Since "G" states a tripping curve and not a sensitivity, these devices (dependent on the range) will be found as:
 - B/Bfq/B+ Type RCCBs (-G/B(fq/+))
- **Type S:** S Types offer a 40ms time delayed tripping curve and surge current proof capabilities up to 5kA and are known as "selective" types. These devices are mainly used in root applications with additional RCDs deployed in series in the system.

Since "S" states a tripping curve and not a sensitivity, these devices (dependent on the range) will be found as:

 - B/Bfq/B+ Type RCCBs (-S/B(fq/+))

Local status indication provided by the digital RCCB

LED signals		red / yellow / green
Permanent light green		Normal operation
Permanent light yellow		The currently measured residual current is higher than 30% I Δ n. The system is currently drawing a fault current, and actions should be taken accordingly.
Permanent light red		The currently measured residual current is higher than 50% I Δ n. The system is currently drawing a critical amount of fault current, and actions should be taken immediately.
Flashing yellow/red		Please press the test button (T). If the LEDs are still present, please refer to the instruction leaflet.

Remotely communicated status indication provided by the digital RCCB

Integrated contact for use in control circuits. Please adhere to the electrical limits of the NO contacts (0,25A ohmic load @ 240V). Without any additional protective measures (eg.: isolation transformer 1:1 according to IEC/EN 60664) the integrated auxiliary contact may only be supplied from the terminals 2, 4, 6, N. See also connection diagrams (2) and (3) for further details.

Accessories:

Auxiliary contact to be mounted on the left side	Z-HK	248432
Auxiliary contact to be mounted on the right side	Z-NHK	248434
Automatic restarting device	Z-FW/LP	248296
	Z-FW-LPD	265244
Remote control unit	Z-FW-MO	284730
Sets (Device + remote control unit)	Z-FW-LP/MO	290171
	Z-FW-LPD/MO	290172
I Δ n testing module	Z-FW/003	248298
	Z-FW/010	248299
	Z-FW/030	248300
Terminal cover 4-poles	Z-RC/AK-4TE	101062

Technical Data

		FRCdM Type B, Bfq and B+
Electrical		
Design according to		Types B and Bfq acc. to IEC/EN 61008, IEC/EN 62423 Types B+ acc. to VDE 0664-400, formerly known as VDE V 0664-110 Type G/B, G/Bfq and G/B+ additional acc. to ÖVE E 8601 IEC 61373, EN 45545-2
Classified according to		
Current test marks as printed onto the device		
Tripping		
Type G		10 ms delay @ 50 Hz
Type S		40 ms delay @ 50 Hz - with selective disconnecting function
Rated voltage	U_n	240/415 V AC 50 Hz and/or 60 Hz – see individual article for operating frequency
Limits operation voltage electronic		50 – 456V AC
Limits operation voltage test circuit		
30 mA		196 - 264V AC
30 mA -400		353 - 456V AC
300 mA		196 - 456V AC
Rated tripping current	$I_{\Delta n}$	30, 300 mA
Sensitivity		All types of current
Rated insulation voltage	U_i	440 V
Rated impulse withstand voltage	U_{imp}	4 kV (1.2/50µs)
Rated short circuit capacity	I_{cn}	10 kA with back-up fuse
Peak withstand current		
Type G/B, G/B+ and G/Bfq		3 kA (8/20 µs) surge current-proof
Type S/B, S/B+ and S/Bfq		5 kA (8/20 µs) selective + surge current-proof
Rated breaking capacity or rated fault breaking capacity	I_m $I_{\Delta m}$	
$I_n = 25-40$ A		500 A
$I_n = 63$ A		630 A
Endurance		
electrical components		≥ 4,000 operating cycles
mechanical components		≥ 20,000 operating cycles
Mechanical		
Frame size		45 mm
Device height		80 mm
Device width		70 mm (4MU)
Mounting		quick fastening with 2 lock-in positions on DIN rail IEC/EN 60715
Degree of protection, built-in		IP40
Degree of protection in moisture-proof enclosure		IP54
Upper and lower terminals		open mouthed/lift terminals
Terminal protection		finger and hand touch safe, DGUV VS3, EN 50274
Terminal capacity		1.5 - 35 mm ² single wire 2 x 16 mm ² multi wire
Terminal screw		M5 (with slotted screw acc. to EN ISO 4757-Z2, Pozidriv PZ2)
Terminal torque		2 - 2.4 Nm
Busbar thickness		0.8 - 2 mm
Operation temperature		-25°C to +40°C (for higher values see table on ambient temperature)
Storage- and transport temperature		-35°C to +60°C
Resistance to climatic conditions		25-55°C/90-95% relative humidity acc. to IEC 60068-2
Contact position indicator		red / green
Tripping indicator		white / blue
Internal contact		
Rated breaking capacity @ 30 V DC (resistive load)		2 A
Rated breaking capacity @ 240 V AC (resistive load)		0.25 A
Maximum switching power (resistive load)		60 W
Maximum switching voltage DC		220 V
Maximum switching voltage AC		240 V
Maximum switching current		2 A
Minimum switching capacity (reference value)		10 µA, 10 mV DC
Endurance		
Electrical (at 20 cpm) 2 A 30 V DC resistive load)		>10 ⁵
Electrical (at 20 cpm) 1 A 30 V DC resistive load)		>5 x 10 ⁵
Terminal capacity		0.25 - 1.5 mm ²

Connection diagram

4-poles (2-Pole)

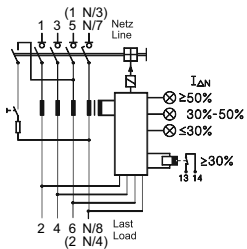

① Basic diagram

4-poles (30mA-400 Types)

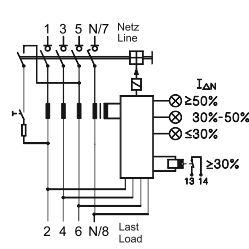

① Basic diagram

4-poles (2-Pole)

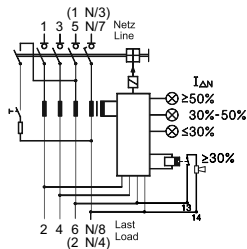

② Signalisation without Isolation Transformer 1:1 (IEC/EN 60664)

4-poles (2-Pole)

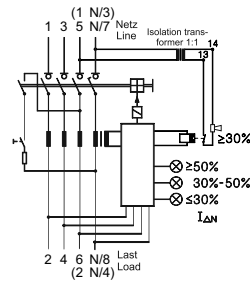

③ Signalisation with Isolation Transformer 1:1 (IEC/EN 60664)

Dimensions (mm)

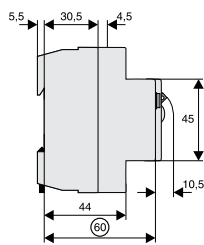
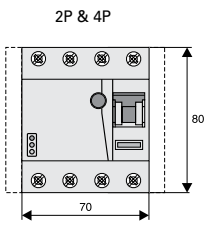

Correct connection

2-pole
30, 300mA Types:

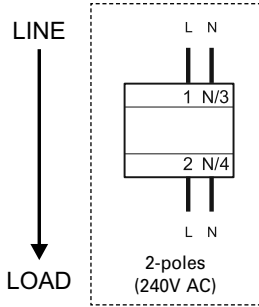

4-pole
30mA -400 Types:

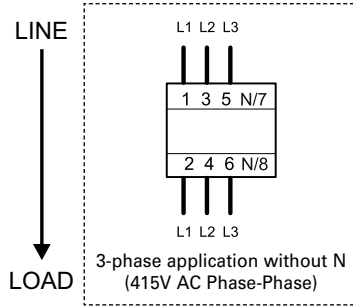

4-pole
30mA Types:

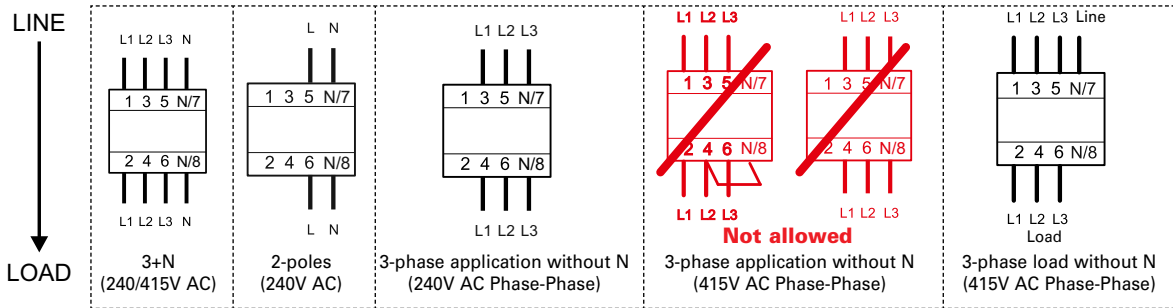

300mA Types:

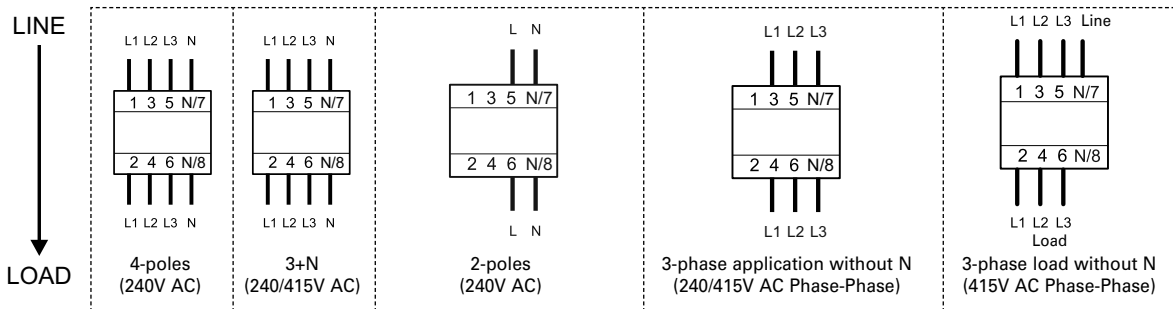

- Disconnect load side of the switch gear, if you make a insulation test of the installation!
- Please take care of supply side and load side!

Tripping current frequency response FRCdM Type B, Bfq and B+

Type B 30mA

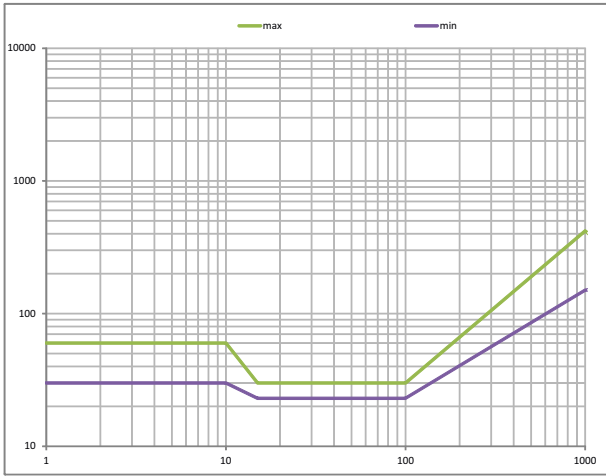

Type B 300mA

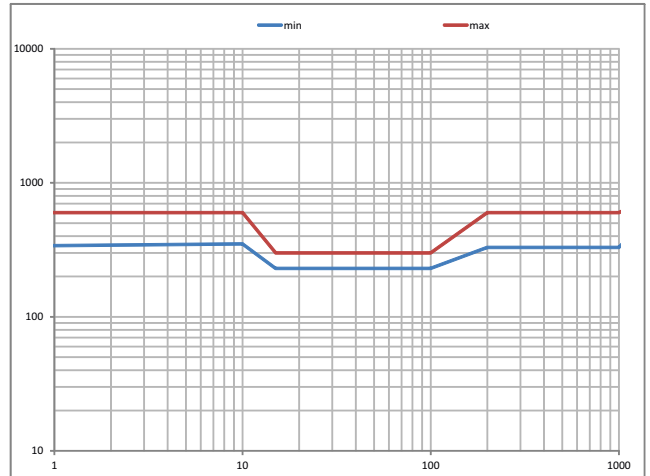

Type B+ 30mA

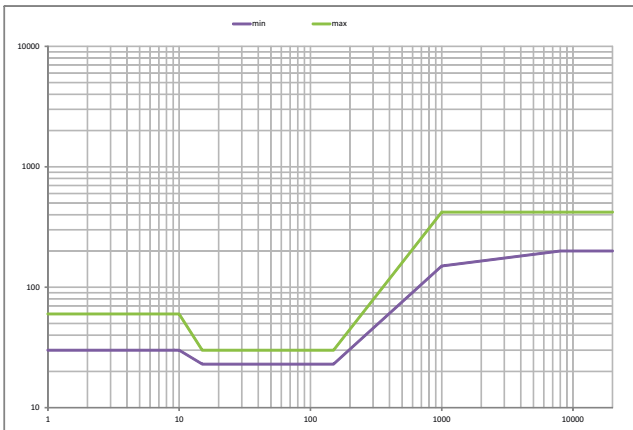

Type B+ 300mA

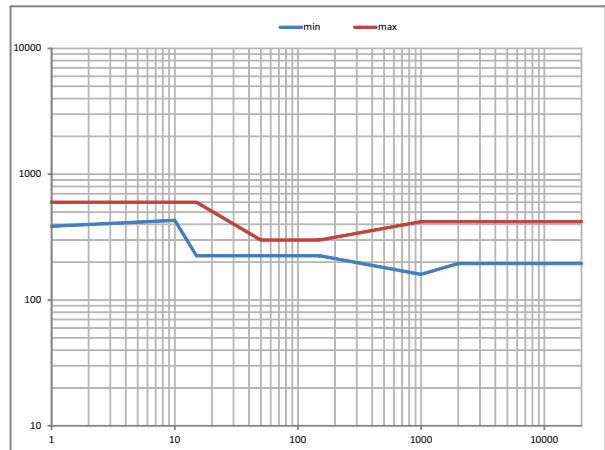

Type Bfq 30mA

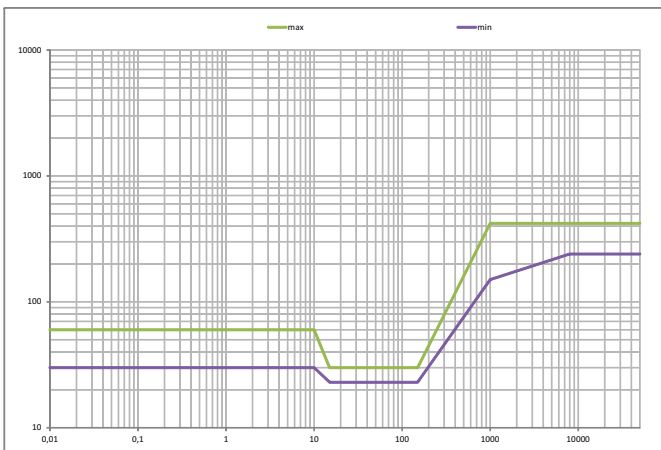

Type Bfq 300mA

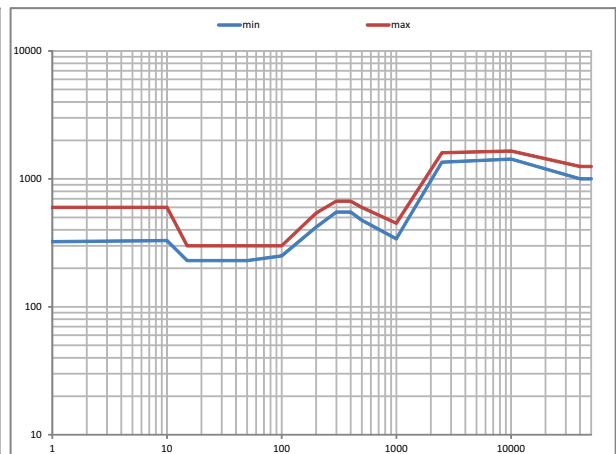

Power Loss at I_n FRCdM

(entire unit)

In [A]	P* [W]	
	2p	4p
25	3.1	4.6
40	4.1	6.2
63	6.7	10

* 50Hz

Impact of ambient temperature on the maximum permanent current allowed (A) FRCdM Type B, Bfq and B+

Ambient temperature	25A	40A	63A
	2p & 4p	2p & 4p	2p & 4p
40°	25	40	63
45°	25	40	56
50°	25	40	50
55°	25	35	45
60°	25	30	40
65°	-	-	-
70°	-	-	-
75°	-	-	-

Note: Please make sure that these values are not exceeded and that any upstream thermal overload protection switches off in time.

Max. back-up fuse FRCdM Type B

Rating In [A]	Fuses		MCB's (Characteristic B/C)	
	Short Circuit [A]	Overload [A]	Short Circuit [A]	Overload [A]
25	63 gG/gI	25 gG/gI	FAZ-C40	FAZ-C25
40	63 gG/gI	40 gG/gI	FAZ-C40	FAZ-C40
63	63 gG/gI	63 gG/gI	FAZ-C40	FAZ-C40

Important:

In the case that the maximal possible operating current of the electrical installation don't exceed the rated current of the RCD only short circuit protection must be implemented. Overload protection must be implemented in the case if the maximal possible operating current of the electrical installation can exceed the rated current of the RCD.

Eaton's electrical business is a global leader with deep regional application expertise in power distribution and circuit protection; power quality, backup power and energy storage; control and automation; life safety and security; structural solutions; and harsh and hazardous environment solutions. Through end-to-end services, channel and an integrated digital platform & insights Eaton is powering what matters across industries and around the world, helping customers solve their most critical electrical power management challenges.

For more information, visit [Eaton.com](https://www.eaton.com).



Eaton Industries (Austria) GmbH
Scheydgasse 42
1210 Vienna
Austria

Eaton
EMEA Headquarters
Route de la Longeraie 7
1110 Morges, Switzerland

© 2022 Eaton
All Rights Reserved
Publication No. CA001017EN
Article number 302001-MK
June 2022

Changes to the products, to the information contained in this document, and to prices are reserved; as are errors and omissions. Only order confirmations and technical documentation by Eaton is binding. Photos and pictures also do not warrant a specific layout or functionality. Their use in whatever form is subject to prior approval by Eaton. The same applies to trademarks (especially Eaton, Moeller, and Cutler-Hammer). The Terms and Conditions of Eaton apply, as referenced on Eaton Internet pages and Eaton order confirmations.

Eaton is a registered trademark.

All other trademarks are property of their respective owners.

Follow us on social media to get the latest product and support information.

