

xEffect - Industrial Switchgear Range Residual Current Devices FRCmM







Catalog





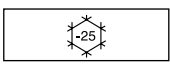
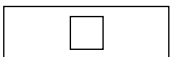
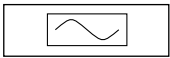

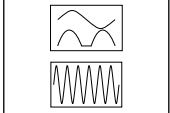

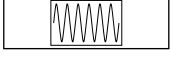
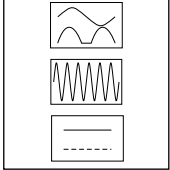
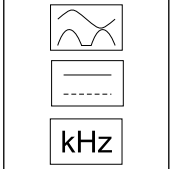
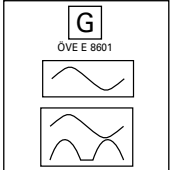
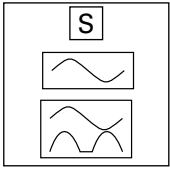















Powering Business Worldwide

Residual Current Devices - General Data

Short description of the most important RCD types

Symbol	Description
	Eaton standard. Suitable for outdoor installation (distribution boxes for outdoor installation and building sites) up to -25° C.
	Conditionally surge-current proof (>250 A, 8/20 μs) for general application.
	Type AC: AC current sensitive RCCB
	Type A: AC and pulsating DC current sensitive RCCB, not affected by smooth DC fault currents up to 6 mA
	Type F: AC and pulsating DC current sensitive RCCB, trips also at frequency mixtures (10 Hz, 50 Hz, 1000 Hz), min. 10 ms time-delayed, min. 3 kA surge current proof, higher load capacity with smooth DC fault currents up to 10 mA
	Frequency range up to 20 kHz
	Trips also at frequency mixtures (10 Hz, 50 Hz, 1000 Hz)
	Type B: All-current sensitive RCD switchgear for applications where DC fault currents may occur. Non-selective, non-delayed. Protection against all kinds of fault currents.
	Type B+: All-current sensitive RCD switchgear for applications where DC fault currents may occur. Non-selective, non-delayed. Protection against all kinds of fault currents. Provides enhanced fire safety.
	RCD of type G (min 10 ms time delay) surge current-proof up to 3 kA. For system components where protection against unwanted tripping is needed to avoid personal injury and damage to property. Also for systems involving long lines with high capacitive reactance. Some versions are sensitive to pulsating DC. Some versions are available in all-current sensitive design.
	RCD of type S (selective, min 40 ms time delay) surge current-proof up to 5 kA. Mainly used as main switch, as well as in combination with surge arresters. This is the only RCD suitable for series connection with other types if the rated tripping current of the downstream RCD does not exceed one third of the rated tripping current of the device of type S. Some versions are sensitive to pulsating DC. Some versions are available in all-current sensitive design.

Kind of residual current and correct use of RCD Types

Kind of current	Current profile	Correct use / application field of RCCB types						Tripping current
		AC	A	F	B	/ B+		
Sinusoidal AC residual current							0.5 to 1.0 $I_{\Delta n}$	
Pulsating DC residual current (positive or negative half-wave)		-					0.35 to 1.4 $I_{\Delta n}$	
Cut half-wave current		-					Lead angle 90°: 0.25 to 1.4 $I_{\Delta n}$ Lead angle 135°: 0.11 to 1.4 $I_{\Delta n}$	
Half-wave with smooth DC current of 6 mA		-					max. 1.4 $I_{\Delta n}$ + 6 mA	
Half-wave with smooth DC current of 10 mA		-	-				max. 1.4 $I_{\Delta n}$ + 10 mA	
Smooth DC current		-	-	-			0.5 to 2.0 $I_{\Delta n}$	

Tripping time

Break time and non-actuating time for alternating residual currents (r.m.s. values) for type AC and A RCCB

Classification	$I_{\Delta n}$ mA		$I_{\Delta n}$	$2xI_{\Delta n}$	$5xI_{\Delta n}$	$5 x I_{\Delta n}$ or 0.25A	500A
Standard RCD Conditionally surge current-proof 250 A	≤30	Max. tripping time (s)	0.3	0.15		0.04	0.04
Standard RCD Conditionally surge current-proof 250 A	>30	Max. tripping time (s)	0.3	0.15	0.04		0.04
RCCB Type G (Short-time-delay) Surge current-proof 3 kA	30	Min. non actuating time(s) Max. tripping time (s)	0.01 0.3	0.01 0.15		0.01 0.04	0.01 0.04
RCCB Type G (Short-time-delay) Surge current-proof 3 kA	>30	Min. non actuating time(s) Max. tripping time (s)	0.01 0.3	0.01 0.15	0.01 0.04		0.01 0.04
RCCB Type S (Selective) Surge current-proof 5 kA	>30	Min. non actuating time(s) Max. tripping time (s)	0.13 0.5	0.06 0.2	0.05 0.15		0.04 0.15

Break time for half-wave pulsating residual currents (r.m.s. values) for type A RCCB

Classification	$I_{\Delta n}$ mA		$1.4xI_{\Delta n}$	$2xI_{\Delta n}$	$2.8xI_{\Delta n}$	$4xI_{\Delta n}$	$7 x I_{\Delta n}$ 0.35 A	0.5 A	350A
Standard RCD Conditionally surge current-proof 250 A	<30	Max. tripping time (s)		0.3		0.15			0.04
Standard RCD Conditionally surge current-proof 250 A	30	Max. tripping time (s)	0.3		0.15		0.04		0.04
Standard RCD Conditionally surge current-proof 250 A	>30	Max. tripping time (s)	0.3		0.15		0.04		0.04
RCCB Type G (Short-time-delay) Surge current-proof 3 kA	30	Max. tripping time (s)	0.3		0.15		0.04		0.04
RCCB Type G (Short-time-delay) Surge current-proof 3 kA	>30	Max. tripping time (s)	0.3		0.15		0.04		0.04
RCCB Type S (Selective) Surge current-proof 5 kA	>30	Max. tripping time (s)	0.5		0.2		0.15		0.15

Tripping Characteristics (IEC/EN 61008)

Tripping characteristics, tripping time range and selectivity of instantaneous, surge current-proof „G“ and surge current-proof - selective „S“ residual current devices.

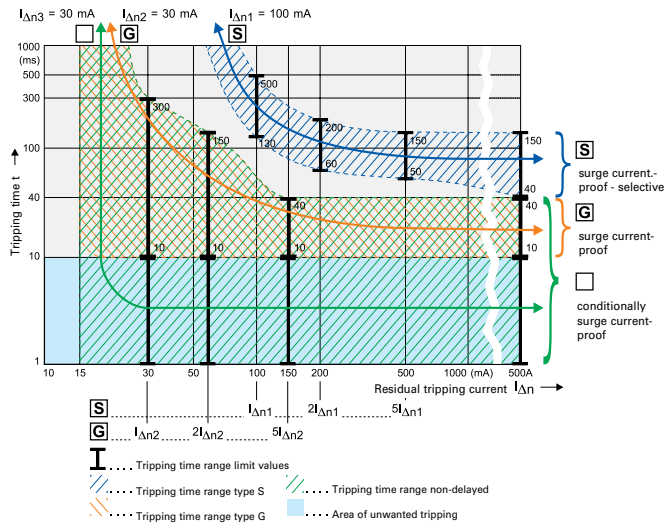

IEC 60364-4-41 deals with additional protection: The use of RCDs with a rated residual operating current not exceeding 30 mA, is recognized in a.c. systems as additional protection in the event of failure of the provision for basic protection and/or the provision for fault protection or carelessness by users.

This means when using RCDs for fault current/residual current protection two RCDs must be connected in series.

Testing:

RCDs with tripping time delay (Types -G and -S) may be function tested with conventional testing equipment which must be set according to the instructions for operation of the testing device. Due to reasons inherent in the measuring process, the tripping time determined in this way may be longer than expected in accordance with the specifications of the manufacturer of the measuring instrument.

However, the device is ok if the result of measurement is within the time range specified by the manufacturer of the measuring instrument.

Applications with frequency converters:

Due to the currents flowing off through the filters (designated IF), the sum of currents through the RCD is not exactly zero, which causes unwanted tripping.

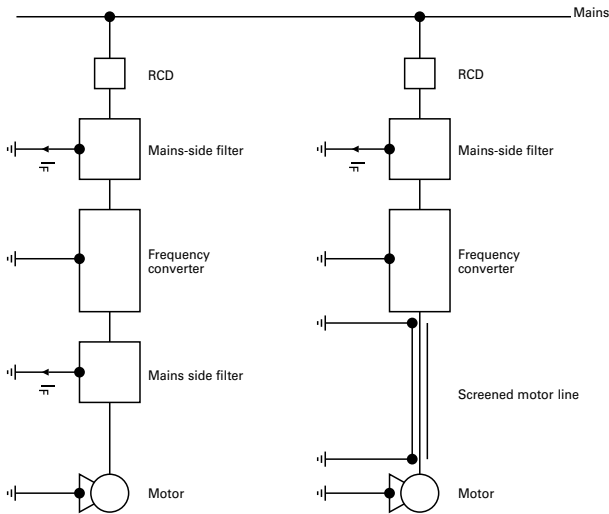

Frequency converters are used in a wide variety of systems and equipment requiring variable speed, such as lifts, escalators, conveyor belts, and large washing machines. Using them for such purposes in circuits with conventional residual current devices causes frequent problems with unwanted tripping.

The technical root cause of this phenomenon is the following: Fast switching operations involving high voltages cause high interference levels which propagate through the lines on the one hand, and in the form of interfering radiation on the other. In order to eliminate this problem, a mains-side filter (also referred to as input filter or EMC-filter) is connected between the RCD and frequency converter. The anti-interference capacitors in the filters produce discharge currents against earth which may cause unwanted tripping of the RCD due to the apparent residual currents. Connecting a filter on the output side between frequency converter and 3-phase AC motor results in the same behaviour.

Tripping characteristic

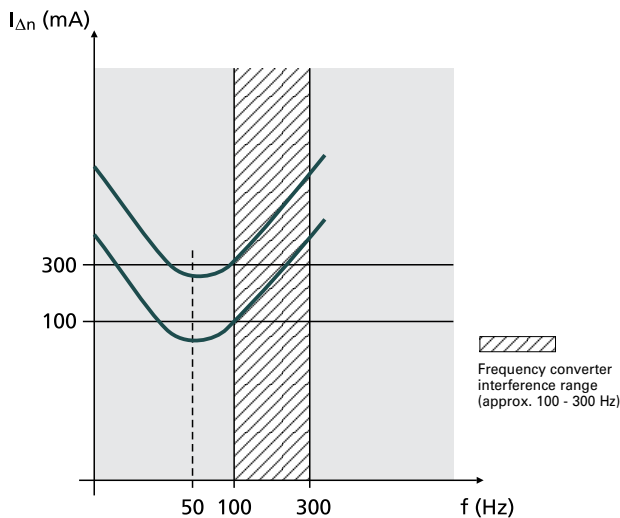

This sample tripping characteristic of a 100 mA RCD and a 300 mA RCD shows the following: In the frequency range around 50 Hz, the RCDs trip as required (50 - 100 % of the indicated $I_{\Delta n}$). In the range shown hatched in the diagram, i. e. from approx. 100 to 300 Hz, unwanted tripping occurs frequently due to the use of frequency converters. Type F RCCBs are designed to reliably sense higher frequency residual currents, which leads to an enormous increase in the reliability and availability of electrical systems.

Therefore, we recommend to use RCDs designed for applications with frequency converter!

These special residual current devices can be recognised by an extension of the type designation („-F“). They meet the requirements of compatibility between RCDs and frequency converters with respect to unwanted tripping.

Eaton stands for highest availability of your system also in applications where frequency drives are used. Therefore a full suite of Type F RCCBs (mechanical and digital assisted) are available in all feasible ratings to assist you in your application needs.

Our RCDs of type „-F“ are characterized by:

- Improved capabilities of reliably sensing residual currents up to 1 kHz
- Improved capabilities of withstanding 10 mA DC offset
- 10 ms short time delay minimum (G/F)
- Surge current proofness of 3 kA (G/F) and 5 kA (S/F)

SG02613



Description

- Line voltage independent RCCB for fault protection, additional protection as well as fire protection
- Complete range of RCCBs available to fulfil all application needs
- Fault current tripping indicator enables to determine the tripping reason
- Comprehensive accessories available
- Suitable to be put into rail rolling stock applications due to additional certification

Residual Current Devices FRCmM

$I_n/I_{\Delta n}$ (A)	Operating frequency (Hz)	Type Designation	Article No.	Units per package
---------------------------	-----------------------------	---------------------	-------------	----------------------

Type AC

Conditionally surge current-proof 250 A, Type AC

2-poles

16/0.03	50	FRCmM-16/2/003	170390	1/60
16/0.1	50	FRCmM-16/2/01	170396	1/60
16/0.3	50	FRCmM-16/2/03	170402	1/60
16/0.5	50	FRCmM-16/2/05	170405	1/60
25/0.03	50	FRCmM-25/2/003	170391	1/60
25/0.1	50	FRCmM-25/2/01	170397	1/60
25/0.3	50	FRCmM-25/2/03	170403	1/60
25/0.5	50	FRCmM-25/2/05	170406	1/60
40/0.03	50	FRCmM-40/2/003	170392	1/60
40/0.1	50	FRCmM-40/2/01	170398	1/60
40/0.3	50	FRCmM-40/2/03	170404	1/60
40/0.5	50	FRCmM-40/2/05	170407	1/60
63/0.03	50	FRCmM-63/2/003	170393	1/60
63/0.1	50	FRCmM-63/2/01	170399	1/60
63/0.5	50	FRCmM-63/2/05	170408	1/60
80/0.03	50	FRCmM-80/2/003	170394	1/60
80/0.1	50	FRCmM-80/2/01	170400	1/60
100/0.03	50	FRCmM-100/2/003	170395	1/60
100/0.1	50	FRCmM-100/2/01	170401	1/60

SG02713



4-poles

16/0.03	50	FRCmM-16/4/003	170409	1/30
16/0.1	50	FRCmM-16/4/01	170415	1/30
16/0.3	50	FRCmM-16/4/03	170418	1/30
16/0.5	50	FRCmM-16/4/05	170424	1/30
25/0.03	50	FRCmM-25/4/003	170410	1/30
25/0.1	50	FRCmM-25/4/01	170416	1/30
25/0.3	50	FRCmM-25/4/03	170419	1/30
25/0.5	50	FRCmM-25/4/05	170425	1/30
40/0.03	50	FRCmM-40/4/003	170411	1/30
40/0.1	50	FRCmM-40/4/01	170417	1/30
40/0.3	50	FRCmM-40/4/03	170420	1/30
40/0.5	50	FRCmM-40/4/05	170426	1/30
63/0.03	50	FRCmM-63/4/003	170412	1/30
63/0.3	50	FRCmM-63/4/03	170421	1/30
63/0.5	50	FRCmM-63/4/05	170427	1/30
80/0.03	50	FRCmM-80/4/003	170413	1/30
80/0.3	50	FRCmM-80/4/03	170422	1/30
80/0.5	50	FRCmM-80/4/05	170428	1/30
100/0.03	50	FRCmM-100/4/003	170414	1/30
100/0.3	50	FRCmM-100/4/03	170423	1/30
100/0.5	50	FRCmM-100/4/05	170429	1/30

SG02613



$I_n/I_{\Delta n}$ (A)	Operating frequency (Hz)	Type Designation	Article No.	Units per package
---------------------------	-----------------------------	---------------------	-------------	----------------------

Type A

Conditionally surge current-proof 250 A, sensitive to residual pulsating DC, Type A

SG02713



2-poles

16/0.03	50/60	FRCmM-16/2/003-A	170430	1/60
16/0.1	50/60	FRCmM-16/2/01-A	170436	1/60
16/0.3	50/60	FRCmM-16/2/03-A	170278	1/60
16/0.5	50	FRCmM-16/2/05-A	170281	1/60
25/0.03	50/60	FRCmM-25/2/003-A	170431	1/60
25/0.1	50/60	FRCmM-25/2/01-A	170437	1/60
25/0.3	50/60	FRCmM-25/2/03-A	170279	1/60
25/0.5	50	FRCmM-25/2/05-A	170282	1/60
40/0.03	50/60	FRCmM-40/2/003-A	170432	1/60
40/0.1	50/60	FRCmM-40/2/01-A	170274	1/60
40/0.3	50/60	FRCmM-40/2/03-A	170280	1/60
40/0.5	50	FRCmM-40/2/05-A	170283	1/60
63/0.03	50/60	FRCmM-63/2/003-A	170433	1/60
63/0.1	50/60	FRCmM-63/2/01-A	170275	1/60
63/0.3	50/60	FRCmM-63/2/03-A	304063	1/60
63/0.5	50	FRCmM-63/2/05-A	170284	1/60
80/0.03	50/60	FRCmM-80/2/003-A	170434	1/60
80/0.1	50/60	FRCmM-80/2/01-A	170276	1/60
80/0.3	50/60	FRCmM-80/2/03-A	304064	1/60
100/0.03	50/60	FRCmM-100/2/003-A	170435	1/60
100/0.1	50/60	FRCmM-100/2/01-A	170277	1/60
100/0.3	50/60	FRCmM-100/2/03-A	304065	1/60

SG02613



4-poles

16/0.03	50/60	FRCmM-16/4/003-A	170285	1/30
16/0.03	50/60	FRCmM-16/4/003-A-400	304101	1/30
16/0.1	50/60	FRCmM-16/4/01-A	170337	1/30
16/0.3	50/60	FRCmM-16/4/03-A	170340	1/30
16/0.5	50	FRCmM-16/4/05-A	170346	1/30
25/0.03	50/60	FRCmM-25/4/003-A	170332	1/30
25/0.03	50/60	FRCmM-25/4/003-A-400	304102	1/30
25/0.1	50/60	FRCmM-25/4/01-A	170338	1/30
25/0.3	50/60	FRCmM-25/4/03-A	170341	1/30
25/0.5	50	FRCmM-25/4/05-A	170347	1/30
40/0.03	50/60	FRCmM-40/4/003-A	170333	1/30
40/0.03	50/60	FRCmM-40/4/003-A-400	304116	1/30
40/0.1	50/60	FRCmM-40/4/01-A	170339	1/30
40/0.3	50/60	FRCmM-40/4/03-A	170342	1/30
40/0.5	50	FRCmM-40/4/05-A	170348	1/30
63/0.03	50/60	FRCmM-63/4/003-A	170334	1/30
63/0.03	50/60	FRCmM-63/4/003-A-400	304167	1/30
63/0.3	50/60	FRCmM-63/4/03-A	170343	1/30
63/0.5	50	FRCmM-63/4/05-A	170349	1/30
80/0.03	50/60	FRCmM-80/4/003-A	170335	1/30
80/0.03	50/60	FRCmM-80/4/003-A-400	304186	1/30
80/0.3	50/60	FRCmM-80/4/03-A	170344	1/30
80/0.5	50	FRCmM-80/4/05-A	170350	1/30
100/0.03	50/60	FRCmM-100/4/003-A	170336	1/30
100/0.03	50/60	FRCmM-100/4/003-A-400	304194	1/30
100/0.3	50/60	FRCmM-100/4/03-A	170345	1/30
100/0.5	50	FRCmM-100/4/05-A	170351	1/30

$I_n/I_{\Delta n}$ (A)	Operating frequency (Hz)	Type Designation	Article No.	Units per package
---------------------------	-----------------------------	---------------------	-------------	----------------------

Type G

Surge current-proof 3 kA, Type G (ÖVE E 8601)

2-poles

16/0.03	50/60	FRCmM-16/2/003-G	170352	1/60
16/0.1	50/60	FRCmM-16/2/01-G	170358	1/60
16/0.3	50/60	FRCmM-16/2/03-G	170364	1/60
25/0.03	50/60	FRCmM-25/2/003-G	170353	1/60
25/0.1	50/60	FRCmM-25/2/01-G	170359	1/60
25/0.3	50/60	FRCmM-25/2/03-G	170365	1/60
40/0.03	50/60	FRCmM-40/2/003-G	170354	1/60
40/0.1	50/60	FRCmM-40/2/01-G	170360	1/60
40/0.3	50/60	FRCmM-40/2/03-G	170366	1/60
63/0.03	50/60	FRCmM-63/2/003-G	170355	1/60
63/0.1	50/60	FRCmM-63/2/01-G	170361	1/60
80/0.03	50/60	FRCmM-80/2/003-G	170356	1/60
80/0.1	50/60	FRCmM-80/2/01-G	170362	1/60
100/0.03	50/60	FRCmM-100/2/003-G	170357	1/60
100/0.1	50/60	FRCmM-100/2/01-G	170363	1/60

SG02713



4-poles

16/0.03	50/60	FRCmM-16/4/003-G	170367	1/30
16/0.1	50/60	FRCmM-16/4/01-G	170373	1/30
16/0.3	50/60	FRCmM-16/4/03-G	170376	1/30
25/0.03	50/60	FRCmM-25/4/003-G	170368	1/30
25/0.1	50/60	FRCmM-25/4/01-G	170374	1/30
25/0.3	50/60	FRCmM-25/4/03-G	170377	1/30
40/0.03	50/60	FRCmM-40/4/003-G	170369	1/30
40/0.1	50/60	FRCmM-40/4/01-G	170375	1/30
40/0.3	50/60	FRCmM-40/4/03-G	170378	1/30
63/0.03	50/60	FRCmM-63/4/003-G	170370	1/30
63/0.3	50/60	FRCmM-63/4/03-G	170379	1/30
80/0.03	50/60	FRCmM-80/4/003-G	170371	1/30
80/0.3	50/60	FRCmM-80/4/03-G	170380	1/30
100/0.03	50/60	FRCmM-100/4/003-G	170372	1/30
100/0.3	50/60	FRCmM-100/4/03-G	170381	1/30

SG02613



$I_n/I_{\Delta n}$ (A)	Operating frequency (Hz)	Type Designation	Article No.	Units per package
---------------------------	-----------------------------	---------------------	-------------	----------------------

Type G/A

Surge current-proof 3 kA, sensitive to residual pulsating DC, Type G/A (ÖVE E 8601)

SG02713



2-poles

16/0.03	50/60	FRCmM-16/2/003-G/A	170382	1/60
16/0.1	50/60	FRCmM-16/2/01-G/A	170388	1/60
16/0.3	50/60	FRCmM-16/2/03-G/A	170290	1/60
25/0.03	50/60	FRCmM-25/2/003-G/A	170383	1/60
25/0.1	50/60	FRCmM-25/2/01-G/A	170389	1/60
25/0.3	50/60	FRCmM-25/2/03-G/A	170291	1/60
40/0.03	50/60	FRCmM-40/2/003-G/A	170384	1/60
40/0.1	50/60	FRCmM-40/2/01-G/A	170286	1/60
40/0.3	50/60	FRCmM-40/2/03-G/A	170292	1/60
63/0.03	50/60	FRCmM-63/2/003-G/A	170385	1/60
63/0.1	50/60	FRCmM-63/2/01-G/A	170287	1/60
80/0.03	50/60	FRCmM-80/2/003-G/A	170386	1/60
80/0.1	50/60	FRCmM-80/2/01-G/A	170288	1/60
100/0.03	50/60	FRCmM-100/2/003-G/A	170387	1/60
100/0.1	50/60	FRCmM-100/2/01-G/A	170289	1/60

SG02613



4-poles

16/0.03	50/60	FRCmM-16/4/003-G/A	170293	1/30
16/0.1	50/60	FRCmM-16/4/01-G/A	170299	1/30
16/0.3	50/60	FRCmM-16/4/03-G/A	170302	1/30
25/0.03	50/60	FRCmM-25/4/003-G/A	170294	1/30
25/0.1	50/60	FRCmM-25/4/01-G/A	170300	1/30
25/0.3	50/60	FRCmM-25/4/03-G/A	170303	1/30
40/0.03	50/60	FRCmM-40/4/003-G/A	170295	1/30
40/0.1	50/60	FRCmM-40/4/01-G/A	170301	1/30
40/0.3	50/60	FRCmM-40/4/03-G/A	170304	1/30
63/0.03	50/60	FRCmM-63/4/003-G/A	170296	1/30
63/0.3	50/60	FRCmM-63/4/03-G/A	170305	1/30
80/0.03	50/60	FRCmM-80/4/003-G/A	170297	1/30
80/0.3	50/60	FRCmM-80/4/03-G/A	170306	1/30
100/0.03	50/60	FRCmM-100/4/003-G/A	170298	1/30
100/0.3	50/60	FRCmM-100/4/03-G/A	170307	1/30

Residual Current Devices FRCmM

$I_n/I_{\Delta n}$ (A)	Operating frequency (Hz)	Type Designation	Article No.	Units per package
---------------------------	-----------------------------	---------------------	-------------	----------------------

Type S

Selective + surge current-proof 5 kA, Type S

2-poles

16/0.1	50/60	FRCmM-16/2/01-S	170314	1/60
25/0.1	50/60	FRCmM-25/2/01-S	170315	1/60
40/0.1	50/60	FRCmM-40/2/01-S	170316	1/60
63/0.1	50/60	FRCmM-63/2/01-S	170317	1/60
80/0.1	50/60	FRCmM-80/2/01-S	170318	1/60
100/0.1	50/60	FRCmM-100/2/01-S	170319	1/60

4-poles

16/0.1	50/60	FRCmM-16/4/01-S	170320	1/30
16/0.3	50/60	FRCmM-16/4/03-S	170324	1/30
25/0.1	50/60	FRCmM-25/4/01-S	170321	1/30
25/0.3	50/60	FRCmM-25/4/03-S	170325	1/30
40/0.1	50/60	FRCmM-40/4/01-S	170322	1/30
40/0.3	50/60	FRCmM-40/4/03-S	170326	1/30
63/0.1	50/60	FRCmM-63/4/01-S	170323	1/30
63/0.3	50/60	FRCmM-63/4/03-S	170327	1/30
80/0.3	50/60	FRCmM-80/4/03-S	170328	1/30
100/0.3	50/60	FRCmM-100/4/03-S	170329	1/30

Type S/A

Selective + surge current-proof 5 kA, sensitive to residual pulsating DC, Type S/A

2-poles

16/0.1	50/60	FRCmM-16/2/01-S/A	170330	1/60
25/0.1	50/60	FRCmM-25/2/01-S/A	170331	1/60
40/0.1	50/60	FRCmM-40/2/01-S/A	170438	1/60
63/0.1	50/60	FRCmM-63/2/01-S/A	170439	1/60
80/0.1	50/60	FRCmM-80/2/01-S/A	170440	1/60
100/0.1	50/60	FRCmM-100/2/01-S/A	170441	1/60

4-poles

16/0.1	50/60	FRCmM-16/4/01-S/A	170442	1/30
16/0.3	50/60	FRCmM-16/4/03-S/A	170446	1/30
25/0.1	50/60	FRCmM-25/4/01-S/A	170443	1/30
25/0.3	50/60	FRCmM-25/4/03-S/A	170447	1/30
40/0.1	50/60	FRCmM-40/4/01-S/A	170444	1/30
40/0.3	50/60	FRCmM-40/4/03-S/A	170448	1/30
63/0.1	50/60	FRCmM-63/4/01-S/A	170445	1/30
63/0.3	50/60	FRCmM-63/4/03-S/A	170449	1/30
80/0.3	50/60	FRCmM-80/4/03-S/A	170450	1/30
100/0.3	50/60	FRCmM-100/4/03-S/A	170451	1/30

SG02713



SG02613



SG02713



SG02613



$I_n/I_{\Delta n}$
(A)

Type
Designation

Article No.

Units per
package

Type G/F

Surge current-proof 3 kA, sensitive to residual pulsating DC, Type G/F (ÖVE E 8601)  

sg01516



2-poles

16/0.03	FRCMM-16/2/003-G/F	187365	1/60
16/0.1	FRCMM-16/2/01-G/F	187371	1/60
16/0.3	FRCMM-16/2/03-G/F	187377	1/60
25/0.03	FRCMM-25/2/003-G/F	187366	1/60
25/0.1	FRCMM-25/2/01-G/F	187372	1/60
25/0.3	FRCMM-25/2/03-G/F	187378	1/60
40/0.03	FRCMM-40/2/003-G/F	187367	1/60
40/0.1	FRCMM-40/2/01-G/F	187373	1/60
40/0.3	FRCMM-40/2/03-G/F	187379	1/60
63/0.03	FRCMM-63/2/003-G/F	187368	1/60
63/0.1	FRCMM-63/2/01-G/F	187374	1/60
63/0.3	FRCMM-63/2/03-G/F	187380	1/60
80/0.03	FRCMM-80/2/003-G/F	187369	1/60
80/0.1	FRCMM-80/2/01-G/F	187375	1/60
80/0.3	FRCMM-80/2/03-G/F	187381	1/60
100/0.03	FRCMM-100/2/003-G/F	187370	1/60
100/0.1	FRCMM-100/2/01-G/F	187376	1/60
100/0.3	FRCMM-100/2/03-G/F	187382	1/60

sg01616





4-poles

16/0.03	FRCMM-16/4/003-G/F	187407	1/30
16/0.1	FRCMM-16/4/01-G/F	187413	1/30
16/0.3	FRCMM-16/4/03-G/F	187419	1/30
25/0.03	FRCMM-25/4/003-G/F	187408	1/30
25/0.1	FRCMM-25/4/01-G/F	187414	1/30
25/0.3	FRCMM-25/4/03-G/F	187420	1/30
40/0.03	FRCMM-40/4/003-G/F	187409	1/30
40/0.1	FRCMM-40/4/01-G/F	187415	1/30
40/0.3	FRCMM-40/4/03-G/F	187421	1/30
63/0.03	FRCMM-63/4/003-G/F	187410	1/30
63/0.1	FRCMM-63/4/01-G/F	187416	1/30
63/0.3	FRCMM-63/4/03-G/F	187422	1/30
80/0.03	FRCMM-80/4/003-G/F	187411	1/30
80/0.1	FRCMM-80/4/01-G/F	187417	1/30
80/0.3	FRCMM-80/4/03-G/F	187423	1/30
100/0.03	FRCMM-100/4/003-G/F	187412	1/30
100/0.1	FRCMM-100/4/01-G/F	187418	1/30
100/0.3	FRCMM-100/4/03-G/F	187424	1/30

$I_n/I_{\Delta n}$ (A)	Type Designation	Article No.	Units per package
---------------------------	---------------------	-------------	----------------------

Type S/F

Selective + surge current-proof 5 kA, sensitive to residual pulsating DC, Type S/F  

sg01516



2-poles

16/0.1	FRCMM-16/2/01-S/F	187389	1/60
16/0.3	FRCMM-16/2/03-S/F	187395	1/60
25/0.1	FRCMM-25/2/01-S/F	187390	1/60
25/0.3	FRCMM-25/2/03-S/F	187396	1/60
40/0.1	FRCMM-40/2/01-S/F	187391	1/60
40/0.3	FRCMM-40/2/03-S/F	187397	1/60
63/0.1	FRCMM-63/2/01-S/F	187392	1/60
63/0.3	FRCMM-63/2/03-S/F	187398	1/60
80/0.1	FRCMM-80/2/01-S/F	187393	1/60
80/0.3	FRCMM-80/2/03-S/F	187399	1/60
100/0.1	FRCMM-100/2/01-S/F	187394	1/60
100/0.3	FRCMM-100/2/03-S/F	187400	1/60

sg01616



4-poles

16/0.1	FRCMM-16/4/01-S/F	187431	1/30
16/0.3	FRCMM-16/4/03-S/F	187437	1/30
25/0.1	FRCMM-25/4/01-S/F	187432	1/30
25/0.3	FRCMM-25/4/03-S/F	187438	1/30
40/0.1	FRCMM-40/4/01-S/F	187433	1/30
40/0.3	FRCMM-40/4/03-S/F	187439	1/30
63/0.1	FRCMM-63/4/01-S/F	187434	1/30
63/0.3	FRCMM-63/4/03-S/F	187440	1/30
80/0.1	FRCMM-80/4/01-S/F	187435	1/30
80/0.3	FRCMM-80/4/03-S/F	187441	1/30
100/0.1	FRCMM-100/4/01-S/F	187436	1/30
100/0.3	FRCMM-100/4/03-S/F	187442	1/30

SG02613



Description

- Line voltage independent RCCB for fault protection, additional protection as well as fire protection
- Complete range of RCCBs available to fulfill all application needs
- Special design to allow ring tongues to be fitted easily (terminal screws are removable)
- Fault current tripping indicator enables to determine the tripping reason
- Comprehensive accessories available
- Suitable to be put into rail rolling stock applications due to additional certification

$I_n/I_{\Delta n}$ (A)	Operating frequency (Hz)	Type Designation	Article No.	Units per package
---------------------------	-----------------------------	---------------------	-------------	----------------------

Type A

Conditionally surge current-proof 250 A, sensitive to residual pulsating DC, Type A

2-poles

16/0.03	50/60	FRCmM-16/4/003-A-RT	305061	1/30
25/0.03	50/60	FRCmM-25/4/003-A-RT	305062	1/30
40/0.03	50/60	FRCmM-40/4/003-A-RT	305063	1/30
63/0.03	50/60	FRCmM-63/4/003-A-RT	305064	1/30
16/0.3	50/60	FRCmM-16/4/03-A-RT	305067	1/30
25/0.3	50/60	FRCmM-25/4/03-A-RT	305068	1/30
40/0.3	50/60	FRCmM-40/4/03-A-RT	305069	1/30
63/0.3	50/60	FRCmM-63/4/03-A-RT	305070	1/30

4-poles

16/0.03	50/60	FRCMM-16/4/003-A-RT	305081	1/30
25/0.03	50/60	FRCMM-25/4/003-A-RT	305082	1/30
40/0.03	50/60	FRCMM-40/4/003-A-RT	305083	1/30
63/0.03	50/60	FRCMM-63/4/003-A-RT	305084	1/30
16/0.3	50/60	FRCMM-16/4/03-A-RT	305088	1/30
25/0.3	50/60	FRCMM-25/4/03-A-RT	305090	1/30
40/0.3	50/60	FRCMM-40/4/03-A-RT	305101	1/30
63/0.3	50/60	FRCMM-63/4/03-A-RT	305102	1/30

Type S

Selective + surge current-proof 5 kA, Type S

2-poles

16/0.3	50/60	FRCMM-16/2/03-S/A-RT	305071	1/30
25/0.3	50/60	FRCMM-25/2/03-S/A-RT	305073	1/30
40/0.3	50/60	FRCMM-40/2/03-S/A-RT	305076	1/30
63/0.3	50/60	FRCMM-63/2/03-S/A-RT	305077	1/30

4-poles

16/0.3	50/60	FRCMM-16/4/03-S/A-RT	305104	1/30
25/0.3	50/60	FRCMM-25/4/03-S/A-RT	305109	1/30
40/0.3	50/60	FRCMM-40/4/03-S/A-RT	305110	1/30
63/0.3	50/60	FRCMM-63/4/03-S/A-RT	305111	1/30

SG02613



SG02613



SG02613



SG02613



Specifications | Residual Current Devices FRCmM

Description

Design

- Residual Current Circuit Breakers (RCCBs) for industrial and commercial applications
- Designed and suitable to be put into an xEffect-System
- Twin-purpose terminal (lift/open-mouthed) above and below
- Tripping indicator white - blue
- Additional safety due:
 - possibility to seal the toggle
 - possibility to lock the toggle
- The device functions irrespective of the position of installation

Accessories

- Busbar positioning optionally above or below
- Free terminal space despite installed busbar
- Auxiliary contacts to be mounted onto the device:
 - Universal tripping signal switch, also suitable for FAZ, FRBmM-1N
 - Auxiliary switch Z-HK can be mounted subsequently

Additional information for the application

- Delayed types suitable for being used with standard fluorescent tubes with or without electronical ballast
 - 30 mA-RCCBs: 30 units per phase conductor
 - 100 mA RCCBs: 90 units per phase conductor

Note: Depending on the fluorescent lamp manufacturer, partly more units possible. Symmetrical allocation of the fluorescent lamp ballasts on all phases favorably. Please still consider the technical data provided by the manufacturer of the lamps.

- Tripping is line voltage independent (VI) and therefore suitable for all BA-classes.

The RCD is suitable for fault protection, additional protection, fire protection within the regulations of the applicable wiring regulations (e.g.: IEC/EN 60364)

- The 4-pole device can also be used for 3-pole and 2 pole applications. Please refer to published connection diagrams

Test Button

- The test button "T" must be pressed once every 6 months. The system operator must be informed of this obligation and his responsibility in a way that can be proven.

Under special conditions (e.g.: damply and/or dusty environments, environments with polluting and/or corroding conditions, environments with large temperature fluctuations, installations with a risk of overvoltage due to switching of equipment and/or atmospheric discharges, portable equipment, ...), it's recommended to test in monthly intervals. Regulations according IEC/EN 60364 or wiring regulations still apply.
- The test button "T" tests the function of the RCCB itself. This test does not measure a "suitable" fault loop or if requirements of such are kept. Testing your fault loop (earth rod resistance, continuity of fault loop,...) requires special tests performed separately.

- **Type A:** These types are capable of sensing pulsating residual currents and are not negatively affected by a DC overlay of up to 6mA. These devices (depended on the range) are also available as:
 - G/A short time delayed devices which are surge current proof up to 3kA. These devices enable a reliable and safe installation with increased system availability
 - S/A selective RCCBs with improved surge current capabilities up to 5kA. These devices are selective (conditions apply) to other RCDs and enable special applications and root installations.
- **Type F:** These types are capable of sensing pulsating residual currents, residual currents up to 1kHz and are not negatively affected by a DC overlay of up to 10mA. They also offer improved availability of your system. These devices (depended on the range) are also available as:
 - G/F short time delayed devices which are surge current proof up to 3 kA. These devices enable a reliable and safe installation with increased system availability
 - S/F selective RCCBs with improved surge current capabilities up to 5kA. These devices are selective (conditions apply) to other RCDs and enable special applications and root installations.
- **Type G:** G Types offer a 10ms time delayed tripping curve and surge current proof capabilities up to 3kA and are highly recommended to be used for applications and installations where system availability is an important factor. Since "G" states a tripping curve and not a sensitivity, these devices (dependent on the range) will be found as:
 - AC sensitive devices (-G)
 - A Type RCCBs (-G/A)
 - F Type RCCBs (-G/F)
 - B/Bfq/B+ Type RCCBs (-G/B(fq/+))
- **Type S:** S Types offer a 40ms time delayed tripping curve and surge current proof capabilities up to 5kA and are know as "selective" types. These devices are mainly used in root applications with additional RCDs deployed in series in the system.

Since "S" states a tripping curve and not a sensitivity, these devices (dependent on the range) will be found as:

 - AC sensitive devices (-S)
 - A Type RCCBs (-S/A)
 - F Type RCCBs (-S/F)

Accessories:

Auxiliary contact to be mounted on the left side	Z-HK	248432
Auxiliary contact to be mounted on the right side	Z-NHK	248434
Automatic restarting device	Z-FW/LP	248296
	Z-FW-LPD	265244
Remote control unit	Z-FW-MO	284730
Sets (Device + remote control unit)	Z-FW-LP/MO	290171
	Z-FW-LPD/MO	290172
IΔn testing module	Z-FW/003	248298
	Z-FW/010	248299
	Z-FW/030	248300
Terminal cover 4-poles	Z-RC/AK-4TE	101062

Technical Data

		FRCmM
Electrical		
Design according to		IEC/EN 61008, IEC/EN 62423 for Type F only Type G acc. to ÖVE E 8601 IEC 61373, EN 45545-2
Classified according to		
Current test marks as printed onto the device		
Tripping		instantaneous
Type G ,		10 ms delay @ 50 Hz
Type S		40 ms delay @ 50 Hz - with selective disconnecting function
Rated voltage	U_n	240/415 V AC 50 Hz and/or 60 Hz – see individual article for operating frequency
Limits operation voltage test circuit		
2-poles		196 - 264 V~
4-poles 30 mA		196 - 264 V~
4-poles 30 mA -400		353 - 456 V~
4-poles 100, 300, 500 mA		196 - 456 V~
Rated tripping current	$I_{\Delta n}$	30, 100, 300, 500 mA
Sensitivity		> AC, Type A and Type F
Rated insulation voltage	U_i	440 V
Rated impulse withstand voltage	U_{imp}	4 kV (1.2/50 μ s)
Rated short circuit capacity	I_{cn}	10 kA with back-up fuse
Peak withstand current		
Type AC, A		250 A (8/20 μ s) surge current-proof
Type G, G/A, G/F		3 kA (8/20 μ s) surge current-proof, 10 ms delay
Type S, S/A, S/F		5 kA (8/20 μ s) surge current-proof, 40 ms delay
Rated breaking capacity or rated fault breaking capacity	I_m $I_{\Delta m}$	
$I_n = 16-40$ A		500 A
$I_n = 63$ A		630 A
$I_n = 80$ A		800 A
$I_n = 100$ A		1,000 A
Endurance		
electrical components		$\geq 4,000$ operating cycles
mechanical components		$\geq 20,000$ operating cycles
Mechanical		
Frame size		45 mm
Device height		80 mm
Device width		35 mm (2MU), 70 mm (4MU)
Mounting		quick fastening with 2 lock-in positions on DIN rail IEC/EN 60715
Degree of protection, built-in		IP40
Degree of protection in moisture-proof enclosure		IP54
Upper and lower terminals		open mouthed/lift terminals
Terminal protection		finger and hand touch safe, DGUV VS3, EN 50274
Terminal capacity		1.5 - 35 mm ² single wire 2 x 16 mm ² multi wire
Terminal screw		M5 (with slotted screw acc. to EN ISO 4757-Z2, Pozidriv PZ2)
Terminal torque		2 - 2.4 Nm
Busbar thickness		0.8 - 2 mm
Operation temperature		-25°C to +40°C (for higher values see table on ambient temperature)
Storage- and transport temperature		-35°C to +60°C
Resistance to climatic conditions		acc. to IEC/EN 61008
Contact position indicator		red / green
Tripping indicator		white / blue

Connection diagram

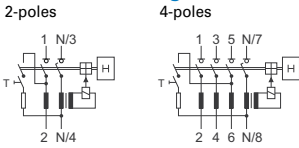

Dimensions (mm)

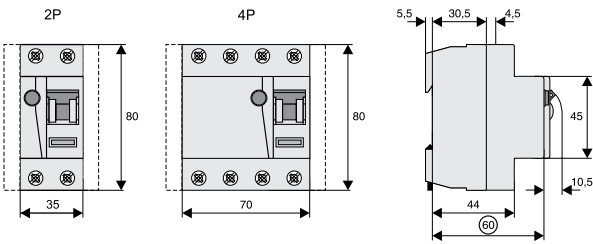

Connection of ring cable lugs (only FRC...RT)

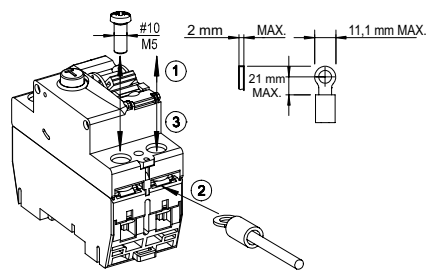

Correct connection

2-poles

30, 100, 300, 500mA Types:

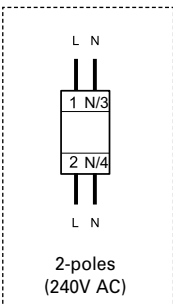

4-poles

30mA -400 Types:

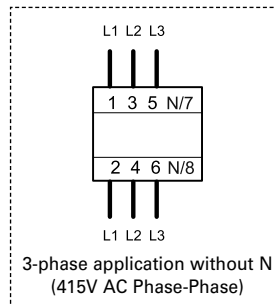

4-poles

30mA Types:

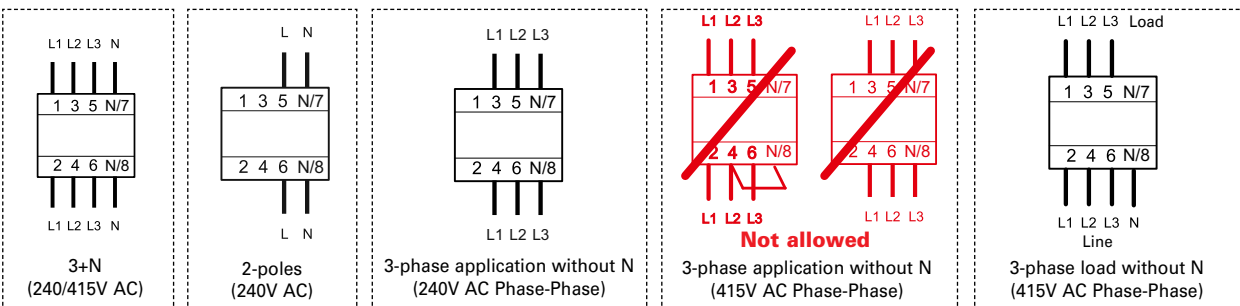

100, 300, 500mA Types:

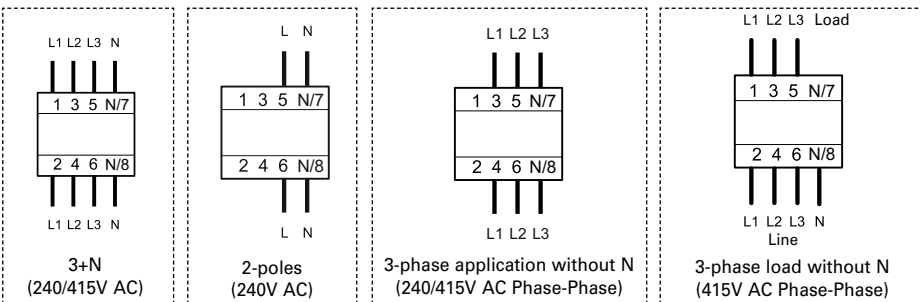

Power Loss at I_n FRCmM

(entire unit)

Tripping: AC

I_n [A]	$I_{\Delta n}$ [mA]	P [W]
2-poles		
16	10	2.9
25	30	2.0
25	100, 300, 500	1.3
40	30	7.8
40	100, 300, 500	5.5
63	30	9.7
63	100, 300, 500	7.2
80	30	13.5
80	100, 300, 500	8.6
100	30, 100, 300	13.6
4-poles		
25	30	3.1
25	100, 300, 500	2.8
40	30	13.1
40	100, 300, 500	8.8
63	30	13.4
63	100, 300, 500	10.5
80	30, 100, 300, 500	11.4
100	30, 100, 300, 500	18.8

Tripping: G, G/A, G/F

I_n [A]	$I_{\Delta n}$ [mA]	P [W]
2-poles		
25	30, 100 (G)	2.0
40	30, 100 (G)	7.8
4-poles		
40	30 (G)	13.1
40	100 (G, G/A)	8.8
40	30 (G/A)	13.1
63	30 (G)	13.4
63	100 (G, G/A)	10.5
63	30 (G/A)	13.4
100	30, 300 (G/A)	18.8

Tripping: A

I_n [A]	$I_{\Delta n}$ [mA]	P [W]
2-poles		
16	10	2.9
16	30	1.2
25	30	2.0
25	100, 300	1.3
40	30	7.8
40	100, 300, 500	5.5
63	30	9.7
63	100, 300, 500	7.2
100	30, 100, 300	13.6
4-poles		
25	30	3.1
25	100, 300, 500	2.8
40	30	13.1
40	100, 300, 500	8.8
63	30, 100, 300, 500	10.5
80	30, 300	11.4
100	30, 100, 300, 500	18.8

Tripping: S, S/A, S/F

I_n [A]	$I_{\Delta n}$ [mA]	P [W]
2-poles		
40	100 (S, S/A)	7.8
40	300 (S)	5.5
4-poles		
25	100, 300 (S)	2.8
25	100 (S/A)	2.8
40	100, 300 (S, S/A)	8.8
63	100, 300 (S)	10.5
63	100, 300 (S/A)	10.5
80	100, 300 (S)	11.4
80	300 (S/A)	11.4
100	300 (S/A)	18.8

Impact of ambient temperature on the maximum permanent current allowed (A) FRCmM

Ambient temperature	25A		40A		63A		80A		100A	
	2p	4p	2p	4p	2p	4p	2p	4p	2p	4p
40°	25	25	40	40	63	63	80	80	100	100
45°	21	22	37	37	59	59	76	76	95	95
50°	18	19	33	34	55	55	72	72	90	90
55°	14	16	30	31	50	50	68	68	85	85
60°	–	–	26	27	45	45	64	64	80	80
65°	–	–	20	24	40	41	60	60	75	75
70°	–	–	14	19	34	37	56	56	70	70
75°	–	–	8	15	28	32	52	52	65	65

Note: Please make sure that these values are not exceeded and that any upstream thermal overload protection switches off in time.

Max. back-up fuse FRCmM

Rating In [A]	Fuses		MCB's (Characteristic B/C)	
	Short Circuit [A]	Overload [A]	Short Circuit [A]	Overload [A]
25	63 gG/gI	25 gG/gI	FAZ-C40	FAZ-C25
40	63 gG/gI	40 gG/gI	FAZ-C40	FAZ-C40
63	63 gG/gI	63 gG/gI	FAZ-C40	FAZ-C40
80	80 gG/gI	80 gG/gI	-	-
100	100 gG/gI	80 gG/gI	-	-

Important:

In the case that the maximal possible operating current of the electrical installation don't exceed the rated current of the RCD only short circuit protection must be implemented. Overload protection must be implemented in the case if the maximal possible operating current of the electrical installation can exceed the rated current of the RCD.

SG02613



Description

- Line voltage independent RCCB for fault protection, additional protection as well as fire protection
- For use in 110V applications
- Complete range of RCCBs available to fulfil all application needs
- Fault current tripping indicator enables to determine the tripping reason
- Comprehensive accessories available
- Suitable to be put into rail rolling stock applications due to additional certification

$I_n/I_{\Delta n}$ (A)	Type Designation	Article No.	Units per package
---------------------------	---------------------	-------------	----------------------

Type AC

Conditionally surge current-proof 250 A, Type AC 

SG02713



2-poles

25/0.03	FRCmM-25/2/003-110	180585	1/60
25/0.3	FRCmM-25/2/03-110	180586	1/60
40/0.03	FRCmM-40/2/003-110	180587	1/60
40/0.3	FRCmM-40/2/03-110	180588	1/60
63/0.03	FRCmM-63/2/003-110	180589	1/60
63/0.3	FRCmM-63/2/03-110	180590	1/60
80/0.03	FRCmM-80/2/003-110	180591	1/60
80/0.3	FRCmM-80/2/03-110	180592	1/60
100/0.03	FRCmM-100/2/003-110	180593	1/60
100/0.3	FRCmM-100/2/03-110	180594	1/60

SG02613



4-poles

25/0.03	FRCmM-25/4/003-110	180595	1/30
25/0.3	FRCmM-25/4/03-110	180596	1/30
40/0.03	FRCmM-40/4/003-110	180597	1/30
40/0.3	FRCmM-40/4/03-110	180598	1/30
63/0.03	FRCmM-63/4/003-110	180599	1/30
63/0.3	FRCmM-63/4/03-110	180600	1/30
80/0.03	FRCmM-80/4/003-110	180601	1/30
80/0.3	FRCmM-80/4/03-110	180602	1/30
100/0.03	FRCmM-100/4/003-110	180603	1/30
100/0.3	FRCmM-100/4/03-110	180604	1/30

Type A

Conditionally surge current-proof 250 A, sensitive to residual pulsating DC, Type A 

SG02713



2-poles

25/0.03	FRCmM-25/2/003-A-110	180605	1/60
25/0.3	FRCmM-25/2/03-A-110	180606	1/60
40/0.03	FRCmM-40/2/003-A-110	180607	1/60
40/0.3	FRCmM-40/2/03-A-110	180608	1/60
63/0.03	FRCmM-63/2/003-A-110	180609	1/60
80/0.03	FRCmM-80/2/003-A-110	180610	1/60
100/0.03	FRCmM-100/2/003-A-110	180611	1/60

SG02613



4-poles

25/0.03	FRCmM-25/4/003-A-110	180612	1/30
25/0.3	FRCmM-25/4/03-A-110	180613	1/30
40/0.03	FRCmM-40/4/003-A-110	180614	1/30
40/0.3	FRCmM-40/4/03-A-110	180615	1/30
63/0.03	FRCmM-63/4/003-A-110	180616	1/30
63/0.3	FRCmM-63/4/03-A-110	180617	1/30
80/0.03	FRCmM-80/4/003-A-110	180618	1/30
80/0.3	FRCmM-80/4/03-A-110	180619	1/30
100/0.03	FRCmM-100/4/003-A-110	180620	1/30
100/0.3	FRCmM-100/4/03-A-110	180621	1/30

Specifications | Residual Current Devices FRCmM-110

Description

Design

- Residual Current Circuit Breakers (RCCBs) for industrial and commercial applications which operate with 110V
- Designed and suitable to be put into an xEffect-System
- Twin-purpose terminal (lift/open-mouthed) above and below
- Contact position indicator red - green
- Tripping indicator white - blue
- Additional safety due:
 - possibility to seal the toggle
 - possibility to lock the toggle
- The device functions irrespective of the position of installation

Accessories

- Busbar positioning optionally above or below
- Free terminal space despite installed busbar
- Auxiliary contacts to be mounted onto the device:
 - Universal tripping signal switch, also suitable for FAZ, FRBmM-11N
 - Auxiliary switch Z-HK can be mounted subsequently

Additional information for the application

- Tripping is line voltage independent (VI) and therefore suitable for all BA-classes.

The RCD is suitable for fault protection, additional protection, fire protection within the regulations of the applicable wiring regulations (e.g.: IEC/EN 60364)

- The 4-pole device can also be used for 3-pole and 2 pole applications. Please refer to published connection diagrams

Test Button

- The test button "T" must be pressed once every 6 months. The system operator must be informed of this obligation and his responsibility in a way that can be proven.

Under special conditions (e.g.: damply and/or dusty environments, environments with polluting and/or corroding conditions, environments with large temperature fluctuations, installations with a risk of overvoltage due to switching of equipment and/or atmospheric discharges, portable equipment, ...), it's recommended to test in monthly intervals. Regulations according IEC/EN 60364 or wiring regulations still apply.

- The test button "T" tests the function of the RCCB itself. This test does not measure a "suitable" fault loop or if requirements of such are kept. Testing your fault loop (earth rod resistance, continuity of fault loop,...) requires special tests performed separately.
- **Type A** These types are capable of sensing pulsating residual currents and are not negatively affected by a DC overlay of up to 6 mA.

Accessories:

Auxiliary contact to be mounted on the left side	Z-HK	248432
Auxiliary contact to be mounted on the right side	Z-NHK	248434
Automatic restarting device	Z-FW/LP	248296
	Z-FW-LPD	265244
Remote control unit	Z-FW-MO	284730
Sets (Device + remote control unit)	Z-FW-LP/MO	290171
	Z-FW-LPD/MO	290172
IΔn testing module	Z-FW/003	248298
	Z-FW/010	248299
	Z-FW/030	248300
	Z-RC/AK-4TE	101062
Terminal cover 4-poles	Z-RC/AK-4TE	101062

Technical Data

		FRCmM-110
Electrical		
Design according to		IEC/EN 61008
Classified according to		IEC 61373, EN 45545-2
Current test marks as printed onto the device		
Tripping		instantaneous
Rated voltage	U_n	110/190V AC, Type AC: 50 Hz, Type A: 50/60 Hz
Limits operation voltage test circuit		2-poles 94 - 121 V~ 4-poles 30 mA 94 - 121 V~ 4-poles 300 mA 94 - 210 V~
Rated tripping current	$I_{\Delta n}$	30, 300 mA
Sensitivity		AC and pulsating DC
Rated insulation voltage	U_i	440 V
Rated impulse withstand voltage	U_{imp}	4 kV (1.2/50µs)
Rated short circuit capacity	I_{cn}	10 kA with back-up fuse
Peak withstand current		
Type AC, A		250 A (8/20 µs) surge current-proof
Rated breaking capacity	I_m	
or rated fault breaking capacity	$I_{\Delta m}$	
$I_n = 16-40$ A		500 A
$I_n = 63$ A		630 A
$I_n = 80$ A		800 A
$I_n = 100$ A		1,000 A
Endurance		
electrical components		≥ 4,000 operating cycles
mechanical components		≥ 20,000 operating cycles
Mechanical		
Frame size		45 mm
Device height		80 mm
Device width		35 mm (2MU), 70 mm (4MU)
Mounting		quick fastening with 2 lock-in positions on DIN rail IEC/EN 60715
Degree of protection, built-in		IP40
Degree of protection in moisture-proof enclosure		IP54
Upper and lower terminals		open mouthed/lift terminals
Terminal protection		finger and hand touch safe, DGUV VS3, EN 50274
Terminal capacity		1.5 - 35 mm ² single wire 2 x 16 mm ² multi wire
Terminal screw		M5 (with slotted screw acc. to EN ISO 4757-Z2, Pozidriv PZ2)
Terminal torque		2 - 2.4 Nm
Busbar thickness		0.8 - 2 mm
Operation temperature		-25°C to +40°C (for higher values see table on ambient temperature)
Storage- and transport temperature		-35°C to +60°C
Resistance to climatic conditions		acc. to IEC/EN 61008
Contact position indicator		red / green
Tripping indicator		white / blue

Connection diagram

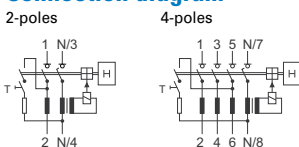

Dimensions (mm)

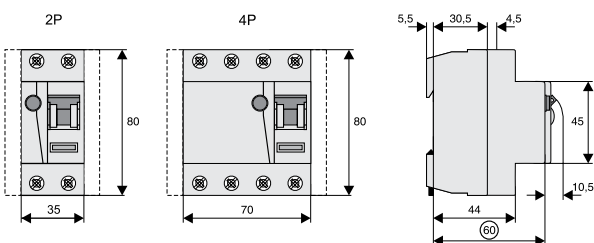

Correct connection

2-poles

30, 300mA Types:

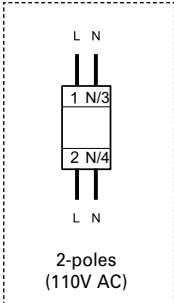

4-poles

30mA Types:

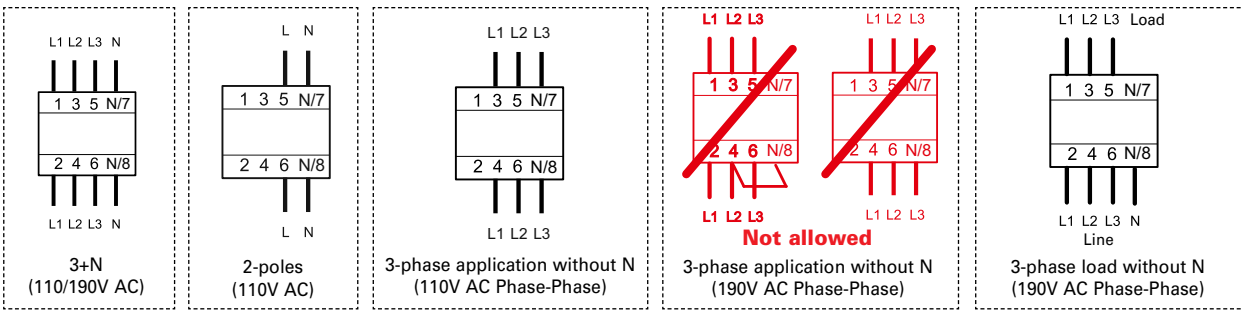

100, 300, 500mA Types:

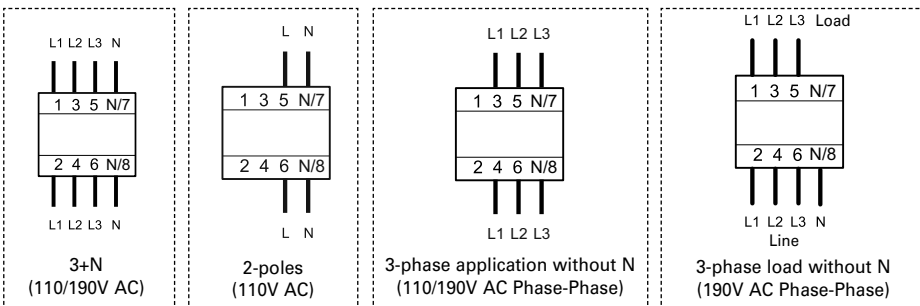

Power Loss at I_n FRCmM-110

(entire unit)

Tripping: AC

I_n [A]	$I_{\Delta n}$ [mA]	P [W]
2-poles		
25	30	2.0
25	100, 300, 500	1.3
40	30	7.8
40	100, 300, 500	5.5
63	30	9.7
63	100, 300, 500	7.2
80	30	13.5
80	100, 300, 500	8.6
100	30, 100, 300	13.6
4-poles		
25	30	3.1
25	100, 300, 500	2.8
40	30	13.1
40	100, 300, 500	8.8
63	30	13.4
63	100, 300, 500	10.5
80	30, 100, 300, 500	11.4
100	30, 100, 300, 500	18.8

Tripping: A

I_n [A]	$I_{\Delta n}$ [mA]	P [W]
2-poles		
16	30	1.2
25	30	2.0
25	100, 300	1.3
40	30	7.8
40	100, 300, 500	5.5
63	30	9.7
63	100, 300, 500	7.2
100	30, 100, 300	13.6
4-poles		
25	30	3.1
25	100, 300, 500	2.8
40	30	13.1
40	100, 300, 500	8.8
63	30, 100, 300, 500	10.5
80	30, 300	11.4
100	30, 100, 300, 500	18.8

Eaton's electrical business is a global leader with deep regional application expertise in power distribution and circuit protection; power quality, backup power and energy storage; control and automation; life safety and security; structural solutions; and harsh and hazardous environment solutions. Through end-to-end services, channel and an integrated digital platform & insights Eaton is powering what matters across industries and around the world, helping customers solve their most critical electrical power management challenges.

For more information, visit [Eaton.com](https://www.eaton.com).



Eaton Industries (Austria) GmbH
Scheydgasse 42
1210 Vienna
Austria

Eaton
EMEA Headquarters
Route de la Longeraie 7
1110 Morges, Switzerland

© 2022 Eaton
All Rights Reserved
Publication No. CA003018EN
Article number 302003-MK
June 2022

Changes to the products, to the information contained in this document, and to prices are reserved; as are errors and omissions. Only order confirmations and technical documentation by Eaton is binding. Photos and pictures also do not warrant a specific layout or functionality. Their use in whatever form is subject to prior approval by Eaton. The same applies to trademarks (especially Eaton, Moeller, and Cutler-Hammer). The Terms and Conditions of Eaton apply, as referenced on Eaton Internet pages and Eaton order confirmations.

Eaton is a registered trademark.

All other trademarks are property of their respective owners.

Follow us on social media to get the latest product and support information.

