

Eaton's P1-40 Switch-disconnectors



EATON

Powering Business Worldwide



We make what matters work.*



At Eaton, we believe that power is a fundamental part of just about everything people do. That's why we're dedicated to helping our customers find new ways to manage electrical, hydraulic and mechanical power more efficiently, safely and sustainably. To improve people's lives, the communities where we live and work, and the planet our future generations depend upon. Because this is what really matters. And we're here to make sure it works.

To learn more go to: [Eaton.com/whatmatters](https://www.eaton.com/whatmatters)

EATON

Powering Business Worldwide

We make what matters work.

Eaton's P1-40 Switch-disconnectors

Eaton's P1-40 Switch-disconnectors bridges the gap between the P1's previous maximum rating of 32 A and the P3's lowest rating of 63 A. It allows for a greater current rating in the compact P1 size.

Eaton's world expertise in the design, manufacture and specifications of switch-disconnectors ensure your application will be protected by the best switching solutions available.

Contact buletechnical@eaton.com for further information.



P1-40 Switch-disconnectors - Overview

Description

Eaton's P1-40 Switch-disconnectors bridges the gap between the P1's previous maximum rating of 32 A and the P3's lowest rating of 63 A. It allows for a greater current rating in the compact P1 size. It is the ideal solution for machine control, automation, production lines, emergency switching and power switching applications.

Mounting options

- Center mounting
- Distribution board mounting
- Flush mounting
- Rear mounting
- Rear mounting with metal extension handle
- Surface mounting in Ci-K Polycarbonate enclosure
- Surface mounting in Ci-K Polycarbonate enclosure with pre-assembled EMC screen
- Surface mounting in steel enclosures

Standards/Approvals

- IEC/EN 60947-3
- IEC/EN 60204

Technical data

- Rated voltage: 690 V a.c.
- Rated current: 40 A
- Utilisation category: AC-21, AC-22, AC-23 and AC-3

Features and benefits

- Compact solution with a 40 Amp current rating allows for higher power applications, future proofing your installation
- Variety of mounting and configuration options available to suit the majority of applications
- Compatible with all existing P1 accessories
- Set of four fork terminals included in box as standard for Main switches and enclosed switches for connection to the additional earth and neutral terminals to accommodate the larger wire sizes at 40 A, ensuring ease of installation



P1-40/EA/SVB/H11
Main switch with auxiliary contacts



P1-40/I2H/N
Surface mounting, switch fitted in polycarbonate
Ci-K Enclosure with metric knockouts



P1-40/IVS-RT
Distribution board On-Off switch

P1-40 Switch-disconnectors - Range overview

		Main switch		On-Off switch	
		With emergency switching off/ emergency stop function	Without emergency switching off/ emergency stop function	On-Off switch	With emergency switching off/ emergency stop function
Center mounting /EZ					
	Without auxiliary contacts			✓	
	With auxiliary contacts				
Distribution board mounting /IVS					
	Without auxiliary contacts			✓	✓
	With auxiliary contacts			✓	
Flush mounting /EA (Main switch) /E (On-off switch)					
	Without auxiliary contacts	✓	✓	✓	✓
	With auxiliary contacts	✓	✓	✓	
Rear mounting /V (Main switch / Z (On-Off switch)					
	Without auxiliary contacts	✓	✓	✓	
	With auxiliary contacts	✓	✓	✓	
Rear mounting with metal extension handle /M4					
	Without auxiliary contacts	✓	✓		
	With auxiliary contacts	✓	✓		
Surface mounting in Ci-K Polycarbonate enclosure /I2					
	Without auxiliary contacts	✓	✓	✓	✓
	With auxiliary contacts	✓	✓	✓	
Surface mounting in Ci-K Polycarbonate enclosure with pre-assembled EMC screen /MBS					
	Without auxiliary contacts	✓	✓		
	With auxiliary contacts	✓	✓		
Surface mounting in steel enclosures /SE1					
	Without auxiliary contacts	✓	✓	✓	
	With auxiliary contacts	✓	✓		

P1-40 Switch-disconnectors - Catalogue number system

Flush mounting 'E' and 'EA'

P	-	Rated current (Amps)	/	Mounting form, switch type, handle type	Options			
					/	Nb of poles	/	Accessories
P1		40		EA/SVB: Flush mounting, main switch with red/yellow handle EA/SVB-SW: Flush mounting, main switch with black handle E: Flush mounting with black thumb grip and front plate E-RT: Flush mounting with red thumb grip		N: 3-pole + Neutral		HI11: With auxiliary contacts with 1 NO/1 NC

Centre mounting 'EZ'

P	-	Rated current (Amps)	/	Switch type, mounting form, handle type	Option	
					/	Nb of poles
P1		40		EZ: Centre mounting, ON-OFF switch with black thumb-grip and front plate EZ-RT: Centre mounting, ON-OFF switch with red thumb grip		N: 3-pole + Neutral

Surface mounting 'I2', switch-disconnector fitted in Ci-K Polycarbonate enclosure

P	-	Rated current (Amps)	/	Mounting form	Ci-K Enclosure size (H x W mm)	H	Options			
							/	Switch type, handle type	/	Nb of poles
P1		40		I: Surface mounting in Ci-K enclosure	2(181 x 100 mm)	H: Hard knockouts	SVB: Main switch with red/yellow handle SVB-SW: Main switch with black handle MBS/SVB: Main switch with red/yellow handle and pre-assembled EMC screen MBS/SVB-SW: Main switch with black handle and pre-assembled EMC screen (Blank) Switch with ON-OFF function		N: 3-pole + Neutral	HI11: With auxiliary contacts with 1 NO/1 NC RT: Red Thumb grip

Surface mounting 'SE1', switch-disconnector fitted in steel enclosure

P	-	Rated current (Amps)	/	Steel enclosure type	Options			
					/	Switch type, handle type	/	Nb of poles
P1		40		SE1	SVB: Main switch with red/yellow handle SVB-SW: Main switch with black handle (Blank) Switch with ON-OFF function		N: 3-pole + Neutral	HI11: With auxiliary contacts with 1 NO/1 NC

Service distribution board mounting 'IVS' switch-disconnectors

P	-	Rated current (Amps)	/	Mounting form, switch type, handle type ⁵	/	Nb of poles
P1		40		IVS: ON-OFF Distribution board mounting switch with black thumb grip and front plate IVS-RT: ON-OFF Distribution board mounting switch with red thumb grip		N: 3-pole + Neutral

P1-40 Switch-disconnectors - Catalogue number system

Rear mounting 'V/SVB', 'M4' and 'Z' switch-disconnectors

P	-	Rated current (Amps)	/	Mounting form, switch type, handle type	/	Options	/	Accessories
P1		40		<p>V/SVB: Rear mounting, main switch with red/yellow handle</p> <p>V/SVB-SW: Rear mounting, main switch with black handle</p> <p>M4/SVB: Rear mounting, main switch with 400 mm extension shaft with red/yellow handle</p> <p>M4/SVB-SW: Rear mounting, main switch with 400 mm extension shaft with blank handle</p> <p>Z : Rear mounting ON-OFF switch with black thumb grip and front plate</p> <p>Z/SVB : Rear mounting ON-OFF main switch with red/yellow handle</p> <p>Z/RT : Rear mounting ON-OFF main switch with red thumb grip</p>		N: 3-pole + Neutral		<p>HI11: With auxiliary contacts with 1 NO/1 NC</p> <p>HI10: With auxiliary contacts with 1 NO/0 NC</p> <p>ZAV/ZVV: with 480 mm aluminium shaft and interlock extension</p> <p>ZAV(X4)/ZVV(X4): with 4 480 mm aluminium shaft and 4 interlock extensions</p>

Accessories - FORKTERM-P1

Description

Eaton's P1-40 Switch-disconnectors Flush mounting Main switch, Rear mounting Main switch and Surface mounting in Ci-K Polycarbonate enclosures come with 4 Fork terminals as standard. They are the ideal solution for connection to the additional earth and neutral terminals to accommodate the larger wire sizes at 40 A.

Eight additional fork terminal FORKTERM-P1 (Y7-400136) can be ordered separately for use with the body terminals and additional terminals such as auxiliary and neutral units.

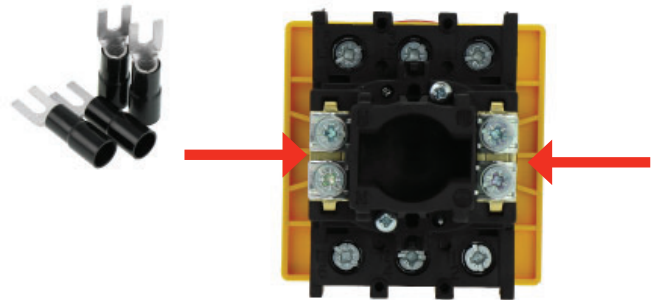

Set of 4 fork terminal to fit on the additional earthing and neutral terminal









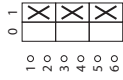
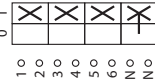
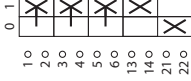
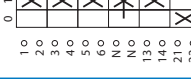

FORKTERM-P1

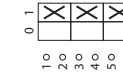
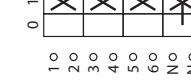
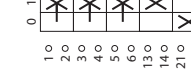
P1-40 Main switches

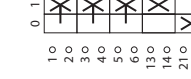
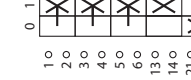
P1-40 Main switch with emergency switching off/emergency stop function - Flush, Rear and Surface mounting

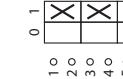
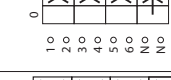
- With red rotary handle and yellow locking collar
- Lockable in the 0 (Off position)
- Front IP65

Front plate	Contact sequence	Auxiliary contacts		Number of poles	Rated current	Part number	Article number	Pack qty	Suitable for export to North America (US) and Canada
		N/O	N/C						
Flush mounting, front IP65									
 FS 908				3	40 A	P1-40/EA/SVB*	199894	1	N/A
				3 + N	40 A	P1-40/EA/SVB/N*	199896	1	N/A
		1	1	3	40 A	P1-40/EA/SVB/HI11*	199895	1	N/A
		1	1	3 + N	40 A	P1-40/EA/SVB/N/HI11*	199897	1	N/A
Surface mounting, switch fitted in Ci-K Polycarbonate enclosure, front IP65, totally insulated									
 FS 908				3	40 A	P1-40/I2/SVB*	199909	1	N/A
					40 A	P1-40/I2H/SVB*	199922	1	N/A
				3 + N	40 A	P1-40/I2/SVB/N*	199911	1	N/A
					40 A	P1-40/I2H/SVB/N*	199924	1	N/A
		1	1	3	40 A	P1-40/I2/SVB/HI11*	199910	1	N/A
					40 A	P1-40/I2H/SVB/HI11*	199923	1	N/A
Surface mounting, switch fitted in Ci-K Polycarbonate enclosure with pre-assembled EMC screen, front IP65, totally insulated									
 FS 908				3	40 A	P1-40/I2H/MBS/SVB*	199917	1	N/A
		1	1	3	40 A	P1-40/I2H/MBS/SVB/HI11*	199918	1	N/A
Surface mounting, switch fitted in steel enclosures, front IP65									
 FS 908				3	40 A	PI-40/SE1/SVB	199946	1	N/A
				3 + N	40 A	PI-40//SE1/SVB/N	199948	1	N/A
		1	1	3	40 A	P1-40/SE1/SVB/HI11	199947	1	N/A



P1-40/EA/SVB



P1-40/I2H/SVB



P1-40/I2H/MBS/SVB



P1-40/SE1/SVB/HI11

* Comes with 4 Fork Terminals as standard

P1-40 Main switches

P1-40 Main switch with emergency switching off/emergency stop function - Rear mounting

- With red rotary handle and yellow locking collar
- Lockable in the 0 (Off position)
- Front IP65

Front plate	Contact sequence	Auxiliary contacts		Number of poles	Rated current	Part number	Article number	Pack qty	Suitable for export to North America (US) and Canada
		N/O	N/C						
Rear mounting, front IP65									
FS 908				3	40 A	P1-40/V/SVB*	199952	1	N/A
				3	40 A	P1-40/V/SVB/ZAV/ZVV	199957	1	N/A
				3	40 A	P1-40/V/SVB/HI11/ZAV/ZVV	199954	1	N/A
				3 + N	40 A	P1-40/V/SVB/N*	199955	1	N/A
		1	1	3	40 A	P1-40/V/SVB/HI11*	199953	1	N/A
		1	1	3 + N	40 A	P1-40/V/SVB/N/HI11*	199956	1	N/A
Rear mounting with 400 mm metal extension handle, front IP65									
FS 908				3	40 A	P1-40/M4/SVB	199936	1	N/A
				3 + N	40 A	P1-40/M4/SVB/N	199938	1	N/A
		1	1	3	40 A	PI-40/M4/SVB/HI11	199937	1	N/A
		1	1	3 + N	40 A	PI-40/M4/SVB/N/HI11	199939	1	N/A



P1-40/V/SVB/HI11









PI-40/M4/SVB/HI11

* Comes with 4 Fork Terminals as standard

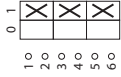
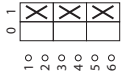
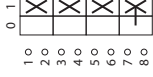
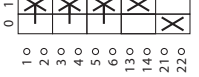
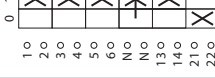
P1-40 Main switches

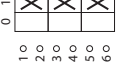
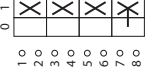
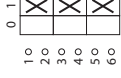
P1-40 Main switch without emergency switching off/emergency stop function - Flush and Surface mounting

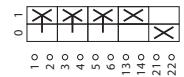
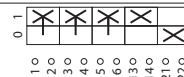
- With black rotary handle and black locking collar
- Lockable in the 0 (Off position)

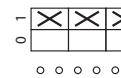
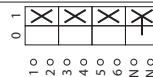
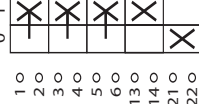

Front plate	Contact sequence	Auxiliary contacts		Number of poles	Rated current	Part number	Article number	Pack qty	Suitable for export to North America (US) and Canada
		N/O	N/C						
Flush mounting, front IP65									
 FS 908				3	40 A	P1-40/EA/SVB-SW*	199898	1	N/A
				3	40 A	P1-40/E/SVB-SW	199893	1	N/A
				3 + N	40 A	P1-40/EA/SVB-SW/N*	199900	1	N/A
		1	1	3	40 A	P1-40/EA/SVB-SW/HI11*	199899	1	N/A
		1	1	3 + N	40 A	P1-40/EA/SVB-SW/N/HI11*	199901	1	N/A
Surface mounting, switch fitted in Ci-K Polycarbonate enclosure, front IP65, totally insulated									
 FS 908				3	40 A	P1-40/I2/SVB-SW*	199912	1	N/A
					40 A	P1-40/I2H/SVB-SW*	199925	1	N/A
				3 + N	40 A	P1-40/I2/SVB-SW/N*	199914	1	N/A
					40 A	P1-40/I2H/SVB-SW/N*	199927	1	N/A
		1	1	3	40 A	P1-40/I2/SVB-SW/HI11*	199913	1	N/A
				40 A	P1-40/I2H/SVB-SW/HI11*	199926	1	N/A	
Surface mounting, switch fitted in Ci-K Polycarbonate enclosure with pre-assembled EMC screen, front IP65 totally insulated									
 FS 908				3	40 A	P1-40/I2H/MBS/SVB-SW*	199919	1	N/A
		1	1	3	40 A	P1-40/I2H/MBS/SVB-SWHI11*	199920	1	N/A
Surface mounting, switch fitted in steel enclosures, front IP65									
 FS 908				3	40 A	P1-40/SE1/SVB-SW	199949	1	N/A
				3 + N	40 A	P1-40/SE1/SVB-SW/N	199951	1	N/A
		1	1	3	40 A	P1-40/SE1/SVB-SW/HI11	199950	1	N/A

* Comes with 4 Fork Terminals as standard

P1-40 Main switches

P1-40 Main switch without emergency switching off/emergency stop function - Rear mounting

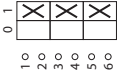
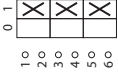
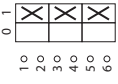
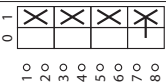
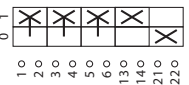
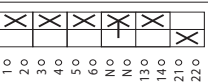
- With black rotary handle and black locking collar
- Lockable in the 0 (Off position)

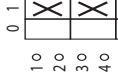
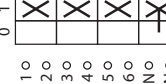
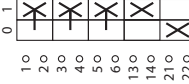
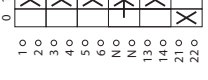
Front plate	Contact sequence	Auxiliary contacts		Number of poles	Rated current	Part number	Article number	Pack qty	Suitable for export to North America (US) and Canada
		N/O	N/C						
Rear mounting, front IP65									
				3	40 A	P1-40/V/SVB-SW*	199958	1	N/A
FS 908				3	40 A	P1-40/V/SVB-SW/ZAV/ZVV	199963	1	N/A
				3	40 A	P1-40/V/SVB-SW/H111/ZAV(X4)/ZVV(X4)	199960	1	N/A
				3 + N	40 A	P1-40/V/SVB-SW/N*	199961	1	N/A
		1	1	3	40 A	P1-40/V/SVB-SW/HI11*	199959	1	N/A
		1	1	3 + N	40 A	P1-40/V/SVB-SW/N/HI11*	199962	1	N/A
Rear mounting with 400 mm metal extension handle, front IP65									
				3	40 A	P1-40/M4/SVB-SW	199940	1	N/A
FS 908				3 + N	40 A	P1-40/M4/SVB-SW/N	199942	1	N/A
		1	1	3	40 A	PI-40/M4/SVB-SW/HI11	199941	1	N/A
		1	1	3 + N	40 A	PI-40/M4/SVB-SW/N/HI11	199943	1	N/A



P1-40/V/SVB-SW/N







PI-40/M4/SVB-SW/N/HI11

* Comes with 4 Fork Terminals as standard

P1-40 On-Off switches

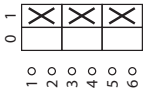
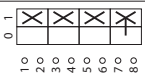
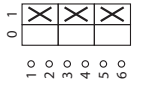
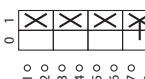
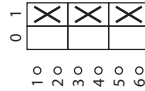
P1-40 On-off switch - Flush , Center and Surface mounting

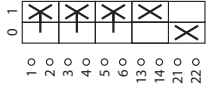
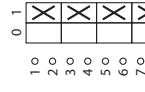
- With black thumb grip and front plate

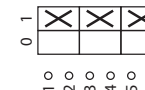
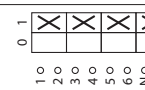
Front plate	Contact sequence	Auxiliary contacts		Number of poles	Rated current	Part number	Article number	Pack qty	Suitable for export to North America (US) and Canada
		N/O	N/C						
Flush mounting, front IP65									
FS 908				3	40 A	P1-40/E	199889	1	N/A
				3 + N	40 A	P1-40/E/N	199891	1	N/A
Center mounting, front IP65									
FS 908				3	40 A	P1-40/EZ	199903	1	N/A
				3 + N	40 A	P1-40/EZ/N	199904	1	N/A
Surface mounting, switch fitted in Ci-K Polycarbonate enclosure, front IP65 totally insulated									
FS 908				3	40 A	P1-40/I2*	199906	1	N/A
				3	40 A	P1-40/I2H*	199915	1	N/A
				3	40 A	P1-40-I2H/Hi11*	199916	1	N/A
				3 + N	40 A	P1-40/I2/N*	199908	1	N/A
				3 + N	40 A	P1-40/I2H/N*	199921	1	N/A
Surface mounting, switch fitted in steel enclosures, front IP65									
FS 908				3	40 A	P1-40/SE1	199944	1	N/A
				3 + N	40 A	P1-40/SE1/N	199945	1	N/A



P1-40/E/N



P1-40/EZ/N



P1-40/I2/N



P1-40-I2H/Hi11





P1-40/SE1/N

* Comes with 4 Fork Terminals as standard

P1-40 On-Off switches

P1-40 On-off switch - Distribution board and Rear mounting

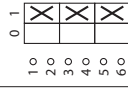
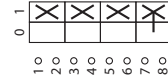
- With black thumb grip and front plate

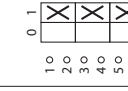
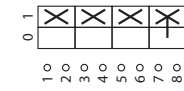
Front plate	Contact sequence	Auxiliary contacts		Number of poles	Rated current	Part number	Article number	Pack qty	Suitable for export to North America (US) and Canada
		N/O	N/C						
Service distribution board mounting, front IP30									
				3	40 A	P1-40/IVS	199931	1	N/A
FS 908				3 + N	40 A	P1-40/IVS/N	199933	1	N/A
Rear mounting, front IP65									
				3	40 A	P1-40/Z	199964	1	N/A
FS 908				3 + N	40 A	P1-40/Z/N	199966	1	N/A











P1-40/IVS

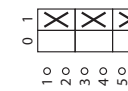

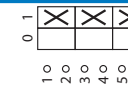
P1-40/Z

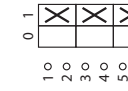
P1-40 On-off switch with an emergency switching off/emergency stop function

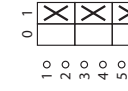
- With red thumb grip and yellow front plate

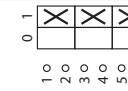
Front plate	Contact sequence	Auxiliary contacts		Number of poles	Rated current	Part number	Article number	Pack qty	Suitable for export to North America (US) and Canada
		N/O	N/C						
Flush mounting, front IP65									
				3	40 A	P1-40/E-RT	199902	1	N/A
FS 908									
Center mounting, front IP65									
				3	40 A	P1-40/EZ/RT	199905	1	N/A
FS 908									
Rear mounting, front IP65									
				3	40 A	P1-40/Z/RT	199968	1	N/A
FS 908									
Surface mounting, switch fitted in Ci-K Polycarbonate enclosure, front IP65, totally insulated									
				3	40 A	P1-40/I2-RT	199930	1	N/A
FS 908									
Service distribution board mounting, front IP30									
				3	40 A	P1-40/IVS-RT	199935	1	N/A
FS 908									

Dimensions - Outline drawings

P1 Flush mounting main switch /EA/SVB

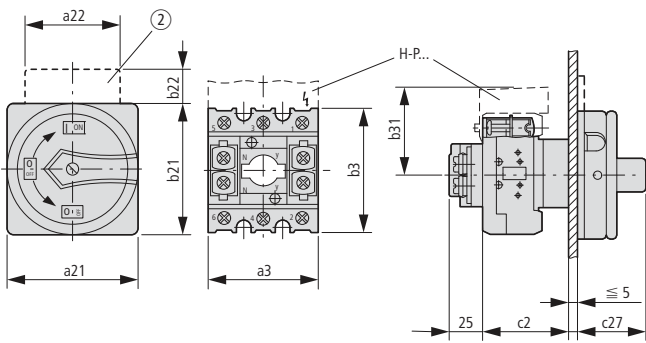

Drilling dimensions door

P1...

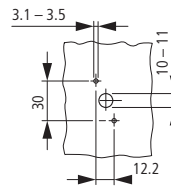

P1 Rear mounting /Z

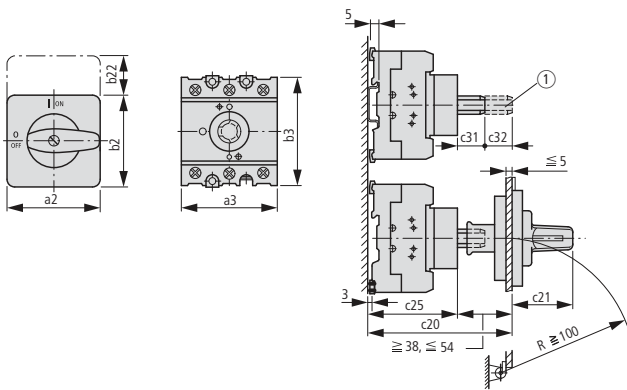

Drilling dimensions base
P1.../Z

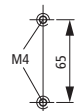

Drilling dimensions door

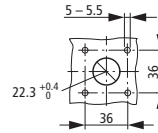

① Shaft extension with ZAV-... possible $\leq 4 \times 25 = 100$ mm

Part no.	a2	a3	a4	a21	a22	a23	a31	a32	a33	b2	b3	b21	b22	b23	b24	b31
P1	48	49	53.5	65	48	87	15	15	83	48	70	65	17	180	32	49

Part no.	c2	c3	c20 \cong/\leq	c20 with ≤ 4 ZAV/ZVV	c21	c22	c23	c24	c25	c27	c28	c31	c32	c33
P1	59	86	96 - 112	212	35	32	65	68	58	35	77	25	25	27

P1 Rear mounting main switch /V/SVB

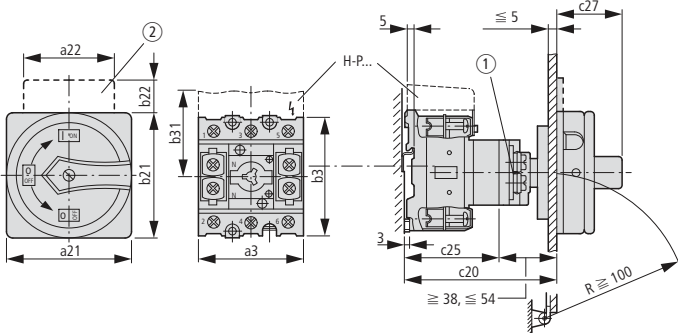

Drilling dimensions base

P1/V/SVB

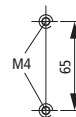

Drilling dimensions door

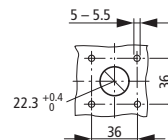

① Interlock extension with ZVV-...+ZAV... possible $\leq 4 \times 25 = 100$ mm

② Not included as standard

Dimensions - Outline drawings

P1 Centre mounting /EZ

P1.../EZ

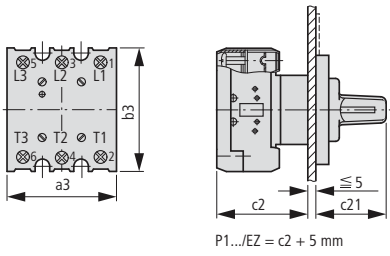

Drilling dimensions door

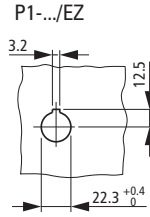

P1 Service distribution board mounting /IVS

P1.../IVS

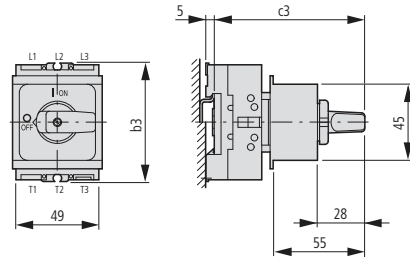

P1 Surface mounting /I2

Surface mounting

P1.../I2

Surface mounting main switches/safety switches

P1.../I2/SVB / P1.../I2/SI

Drilling dimensions

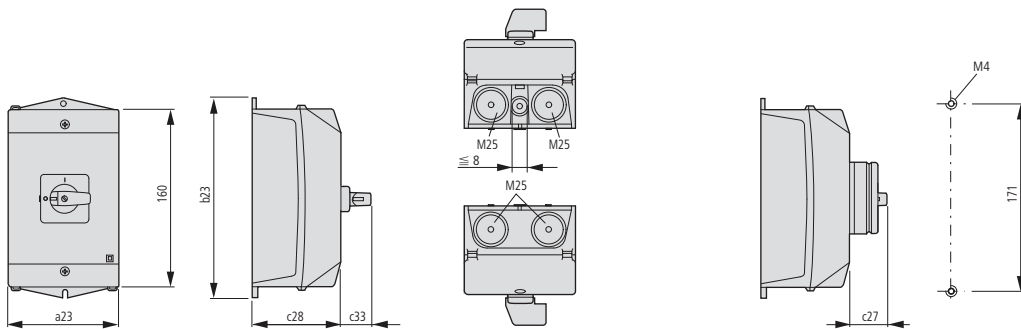

Part no.	a2	a3	a4	a21	a22	a23	a31	a32	a33	b2	b3	b21	b22	b23	b24	b31
P1.../I2	48	49	53.5	65	48	100	15	15	83	48	70	65	17	180	35.5	49

Part no.	c2	c3	c20 ≧/≦	c20 with ≦ 4 ZAV/ZVV	c21	c22	c23	c24	c25	c27	c28	c31	c32	c33
P1...	59	86	96 - 112	212	35	32	65	68	58	35	80	25	25	27

P1 Surface mounting main switch /I2H/MBS/SVB with pre-assembled EMC screen

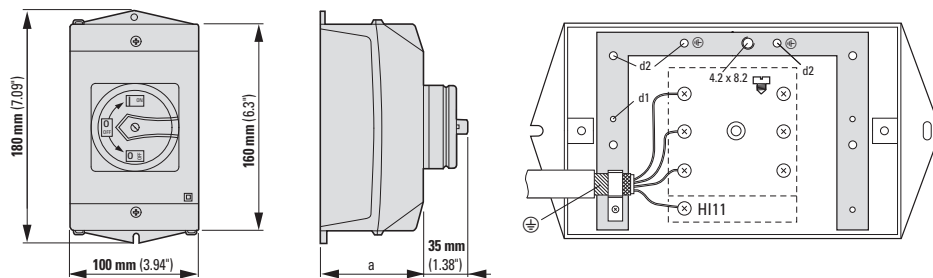

a = 101 mm (3.98")

mm	in	mm	Ø	mm	in
7	0.28	2 x 4.2 x 8.2	d1	3.5	0.14
8	0.32	2 x 4.2 x 8.2	d1	3.5	0.14
10	0.39	2 x 4.2 x 8.2	d1	3.5	0.14
12	0.47	2 x 4.8 x 10.5	d2	4.1	0.16

Technical data

				P1-40
General				
Standards		IEC/EN 60947, IEC/EN 60204, switch-disconnector to IEC/EN 60947-3		
Lifespan mechanical	Operations	x 10 ⁶	0.3	
Maximum operating frequency	Operations/h	50		
Climatic proofing		Damp heat, constant to IEC 60068-2-78 Damp heat, cyclical to IEC 60068-2-30		
Ambient temperature	Open	°C	-25 - 50	
	Enclosed	°C	-25 - 40	
Mounting position		Any		
Mechanical shock resistance (IEC/EN 60068-2-27)	Half-sinusoidal shock 20 ms	g	15	
Contacts				
Rated operational voltage	U _e	V A C	690	
Rated impulse withstand voltage	U _{imp}	V A C	6000	
Overvoltage category/pollution degree		III/3		
Rated uninterrupted current	I _u	A	40	
Maximum fuse rating	Fuse	A gG/gL	50	
Rated short-time withstand current (1s current)	I _{cw}	A _{rms}	640	
Isolating characteristics to IEC/EN 60947		V A C	≤ 690	
Safe isolation according to EN 61140 between the auxiliary contacts and main circuits		V A C	440	
Switching angle		°	90	
Contacts		Number	Max. 3 (+N)	
Current heat loss per contact at I _e		W	1.9	
Terminal				
Solid or stranded		mm ²	1 x (1.5-10) 2 x (1.5-10)	
Flexible with ferrule to DIN 46228		mm ²	1 x (1-4) 2 x (1-4)	
Fork terminal		mm ²	1 x (1.5-10) 2 x (1.5-10)	
Terminal screw		M4		
Tightening torque		Nm	1.6	
Switching capacity				
AC Voltage				
Rated making capacity cos φ = 0.45		A	360	
Rated breaking capacity, motor load switch cos φ = 0.45	400/415 V	A	290	
	690 V	A	130	
Rated operational current 440V, load-break switch AC-21A		I _e	A	40
AC-3 motor load switch motor load	230 V	P	kW	7.5
	400/415 V	P	kW	15
	690 V	P	kW	15
AC-23A motor load switch motor load	230 V	P	kW	11
	400/415 V	P	kW	22
	690 V	P	kW	18.5

Note: Main switch characteristics to IEC/EN 60204; positive opening of contacts, operator element positively located on shaft. Rated uninterrupted current I_u is specified for max cross-section. For terminal capacity solid, stranded and flexible and fork terminal: Max. 2 cross-section sizes difference admissible when using 2 conductors.

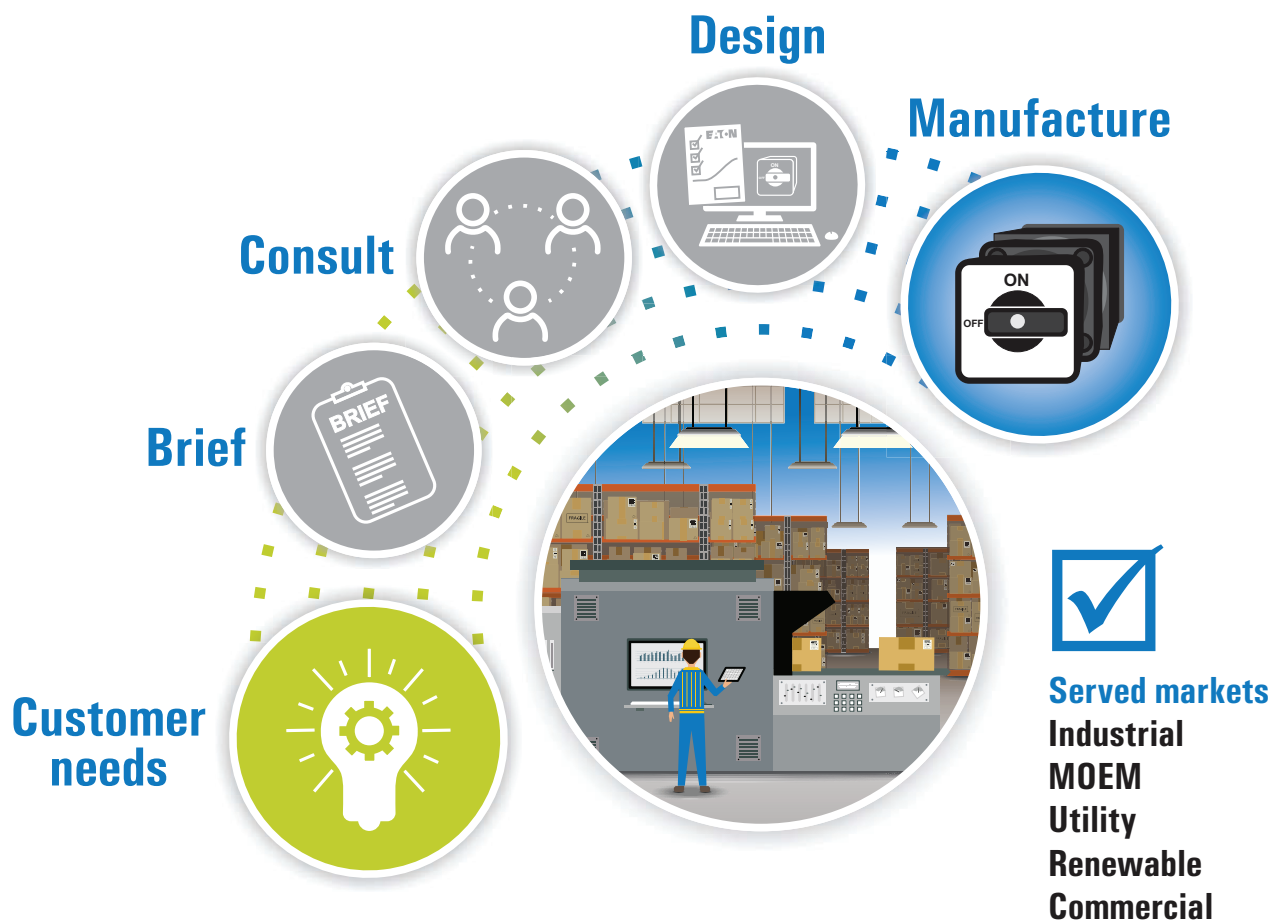

Our services include:

- Customised mounting connections.
- Acquire UL/IEC/CCC/CSA certificates.
- Customised testing such as temperature rise or vibration.
- Special plating for connection terminal.
- Modification of enclosures.
- Additional earthing arrangements.
- Custom printed face plates.
- Unique control switching configurations.

Contact us today...
 buletechnical@eaton.com

Eaton is an intelligent power management company dedicated to improving the quality of life and protecting the environment for people everywhere. We are guided by our commitment to do business right, to operate sustainably and to help our customers manage power - today and well into the future. By capitalizing on the global growth trends of electrification and digitalization, we're accelerating the planet's transition to renewable energy, helping to solve the world's most urgent power management challenges, and doing what's best for our stakeholders and all of society.

Founded in 1911, Eaton has been listed on the NYSE for nearly a century. We reported revenues of \$19.6 billion in 2021 and serve customers in more than 170 countries. For more information, visit www.eaton.com. Follow us on Twitter and LinkedIn.

Eaton

EMEA Headquarters
Route de la Longeraie 7
1110 Morges, Switzerland

Electrical Sector
Eaton Electrical Products Limited
Unit 1, Hawker Business Park
Melton Road
Burton-on-the-Wolds
LE12 5TH
UK

Changes to the products, to the information contained in this document, and to prices are reserved; so are errors and omissions. Only order confirmations and technical documentation by Eaton is binding. Photos and pictures also do not warrant a specific layout or functionality. Their use in whatever form is subject to prior approval by Eaton. The same applies to Trademarks (especially Eaton, Moeller, and Cutler-Hammer). The Terms and Conditions of Eaton apply, as referenced on Eaton Internet pages and Eaton order confirmations.

© 2022 Eaton
All Rights Reserved
PDF only
Publication No. CA04200EN
December 2022

Eaton is a registered trademark.

All other trademarks are property of their respective owners.

Follow us on social media to get the latest product and support information.

