

xEffect - Industrial Switchgear Range Combined RCD/MCB Devices FRBm6









Catalog



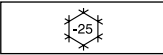

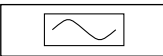

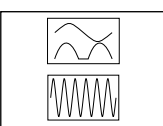

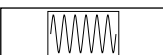
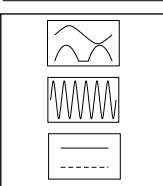
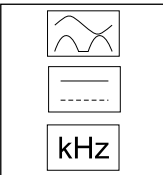
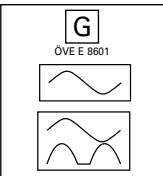
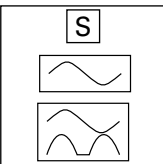

















Powering Business Worldwide

Residual Current Devices - General Data

Short description of the most important RCD types

Symbol	Description
	Eaton standard. Suitable for outdoor installation (distribution boxes for outdoor installation and building sites) up to -25° C.
	Conditionally surge-current proof (>250 A, 8/20 μs) for general application.
	Type AC: AC current sensitive RCCB
	Type A: AC and pulsating DC current sensitive RCCB, not affected by smooth DC fault currents up to 6 mA
	Type F: AC and pulsating DC current sensitive RCCB, trips also at frequency mixtures (10 Hz, 50 Hz, 1000 Hz), min. 10 ms time-delayed, min. 3 kA surge current proof, higher load capacity with smooth DC fault currents up to 10 mA
	Frequency range up to 20 kHz
	Trips also at frequency mixtures (10 Hz, 50 Hz, 1000 Hz)
	Type B: All-current sensitive RCD switchgear for applications where DC fault currents may occur. Non-selective, non-delayed. Protection against all kinds of fault currents.
	Type B+: All-current sensitive RCD switchgear for applications where DC fault currents may occur. Non-selective, non-delayed. Protection against all kinds of fault currents. Provides enhanced fire safety.
	RCD of type G (min 10 ms time delay) surge current-proof up to 3 kA. For system components where protection against unwanted tripping is needed to avoid personal injury and damage to property. Also for systems involving long lines with high capacitive reactance. Some versions are sensitive to pulsating DC. Some versions are available in all-current sensitive design.
	RCD of type S (selective, min 40 ms time delay) surge current-proof up to 5 kA. Mainly used as main switch, as well as in combination with surge arresters. This is the only RCD suitable for series connection with other types if the rated tripping current of the downstream RCD does not exceed one third of the rated tripping current of the device of type S. Some versions are sensitive to pulsating DC. Some versions are available in all-current sensitive design.

Kind of residual current and correct use of RCD Types

Kind of current	Current profile	Correct use / application field of RCCB types						Tripping current
		AC	A	F	B	/ B+		
Sinusoidal AC residual current								0.5 to 1.0 $I_{\Delta n}$
Pulsating DC residual current (positive or negative half-wave)		-						0.35 to 1.4 $I_{\Delta n}$
Cut half-wave current		-						Lead angle 90°: 0.25 to 1.4 $I_{\Delta n}$ Lead angle 135°: 0.11 to 1.4 $I_{\Delta n}$
Half-wave with smooth DC current of 6 mA		-						max. 1.4 $I_{\Delta n}$ + 6 mA
Half-wave with smooth DC current of 10 mA		-	-					max. 1.4 $I_{\Delta n}$ + 10 mA
Smooth DC current		-	-	-				0.5 to 2.0 $I_{\Delta n}$

Tripping time

Break time and non-actuating time for alternating residual currents (r.m.s. values) for type AC and A RCCB

Classification	$I_{\Delta n}$ mA		$I_{\Delta n}$	$2xI_{\Delta n}$	$5xI_{\Delta n}$	$5 x I_{\Delta n}$ or 0.25A	500A
Standard RCD Conditionally surge current-proof 250 A	≤30	Max. tripping time (s)	0.3	0.15		0.04	0.04
Standard RCD Conditionally surge current-proof 250 A	>30	Max. tripping time (s)	0.3	0.15	0.04		0.04
RCCB Type G (Short-time-delay) Surge current-proof 3 kA	30	Min. non actuating time(s) Max. tripping time (s)	0.01 0.3	0.01 0.15		0.01 0.04	0.01 0.04
RCCB Type G (Short-time-delay) Surge current-proof 3 kA	>30	Min. non actuating time(s) Max. tripping time (s)	0.01 0.3	0.01 0.15	0.01 0.04		0.01 0.04
RCCB Type S (Selective) Surge current-proof 5 kA	>30	Min. non actuating time(s) Max. tripping time (s)	0.13 0.5	0.06 0.2	0.05 0.15		0.04 0.15

Break time for half-wave pulsating residual currents (r.m.s. values) for type A RCCB

Classification	$I_{\Delta n}$ mA		$1.4xI_{\Delta n}$	$2xI_{\Delta n}$	$2.8xI_{\Delta n}$	$4xI_{\Delta n}$	$7 x I_{\Delta n}$	0.35 A	0.5 A	350A
Standard RCD Conditionally surge current-proof 250 A	<30	Max. tripping time (s)		0.3		0.15			0.04	0.04
Standard RCD Conditionally surge current-proof 250 A	30	Max. tripping time (s)	0.3		0.15		0.04			0.04
Standard RCD Conditionally surge current-proof 250 A	>30	Max. tripping time (s)	0.3		0.15		0.04			0.04
RCCB Type G (Short-time-delay) Surge current-proof 3 kA	30	Max. tripping time (s)	0.3		0.15		0.04			0.04
RCCB Type G (Short-time-delay) Surge current-proof 3 kA	>30	Max. tripping time (s)	0.3		0.15		0.04			0.04
RCCB Type S (Selective) Surge current-proof 5 kA	>30	Max. tripping time (s)	0.5		0.2		0.15			0.15

Tripping Characteristics (IEC/EN 61008)

Tripping characteristics, tripping time range and selectivity of instantaneous, surge current-proof „G“ and surge current-proof - selective „S“ residual current devices.

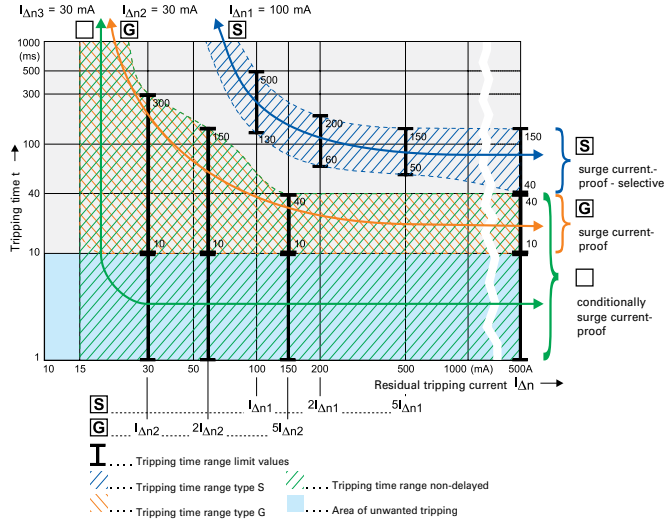

IEC 60364-4-41 deals with additional protection: The use of RCDs with a rated residual operating current not exceeding 30 mA, is recognized in a.c. systems as additional protection in the event of failure of the provision for basic protection and/or the provision for fault protection or carelessness by users.

This means when using RCDs for fault current/residual current protection two RCDs must be connected in series.

Testing:

RCDs with tripping time delay (Types -G and -S) may be function tested with conventional testing equipment which must be set according to the instructions for operation of the testing device. Due to reasons inherent in the measuring process, the tripping time determined in this way may be longer than expected in accordance with the specifications of the manufacturer of the measuring instrument.

However, the device is ok if the result of measurement is within the time range specified by the manufacturer of the measuring instrument.

Applications with frequency converters:

Due to the currents flowing off through the filters (designated IF), the sum of currents through the RCD is not exactly zero, which causes unwanted tripping.

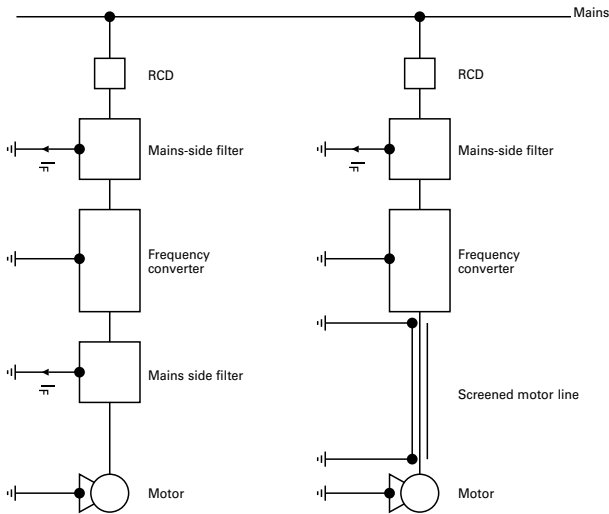

Frequency converters are used in a wide variety of systems and equipment requiring variable speed, such as lifts, escalators, conveyor belts, and large washing machines. Using them for such purposes in circuits with conventional residual current devices causes frequent problems with unwanted tripping.

The technical root cause of this phenomenon is the following: Fast switching operations involving high voltages cause high interference levels which propagate through the lines on the one hand, and in the form of interfering radiation on the other. In order to eliminate this problem, a mains-side filter (also referred to as input filter or EMC-filter) is connected between the RCD and frequency converter. The anti-interference capacitors in the filters produce discharge currents against earth which may cause unwanted tripping of the RCD due to the apparent residual currents. Connecting a filter on the output side between frequency converter and 3-phase AC motor results in the same behaviour.

Tripping characteristic

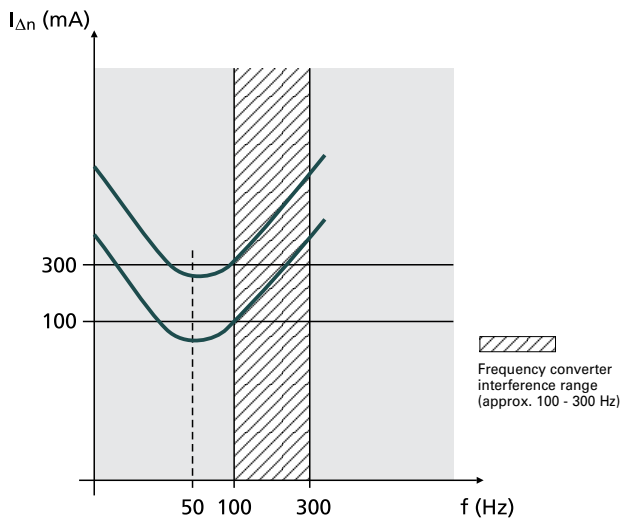

This sample tripping characteristic of a 100 mA RCD and a 300 mA RCD shows the following: In the frequency range around 50 Hz, the RCDs trip as required (50 - 100 % of the indicated $I_{\Delta n}$).

In the range shown hatched in the diagram, i. e. from approx. 100 to 300 Hz, unwanted tripping occurs frequently due to the use of frequency converters. Type F RCCBs are designed to reliably sense higher frequency residual currents, which leads to an enormous increase in the reliability and availability of electrical systems.

Therefore, we recommend to use RCDs designed for applications with frequency converter!

These special residual current devices can be recognised by an extension of the type designation („-F“). They meet the requirements of compatibility between RCDs and frequency converters with respect to unwanted tripping.

Eaton stands for highest availability of your system also in applications where frequency drives are used. Therefore a full suite of Type F RCCBs (mechanical and digital assisted) are available in all feasible ratings to assist you in your application needs.

Our RCDs of type „-F“ are characterized by:

- Improved capabilities of reliably sensing residual currents up to 1 kHz
- Improved capabilities of withstanding 10 mA DC offset
- 10 ms short time delay minimum (G/F)
- Surge current proofness of 3 kA (G/F) and 5kA (S/F)

SG03013



Description

- High-quality residual current device / miniature circuit breaker combination, line voltage-independent
- Increased protection in applications with 1-phase frequency converter due to the detection of mixed frequencies (type F)
- Reduction of nuisance tripping (type F, G, or G/A) thanks to
 - time delayed tripping
 - increased current withstand capability >3 kA
- Higher load rating with DC residual currents up to 10 mA (type F)
- Contact position indicator red - green
- Fault current tripping indicator
- Guide for secure terminal connection
- 3-position DIN rail clip, permits removal from existing busbar system
- Comprehensive range of accessories suitable for subsequent installation
- Wide variety of rated tripping currents
- Rated currents up to 40 A
- Tripping characteristics B, C, D
- Rated breaking capacity acc. to IEC/EN 61009 10 kA
- Rated breaking capacity acc. to IEC/EN 60947-2 up to 15 kA
- Classified for the use in rail rolling stock

Type G/A

6 kA, 1+N-poles

Surge current-proof 3 kA, sensitive to residual pulsating DC, Type G/A (ÖVE E 8601) 

SG03013



Characteristic B

13/003	FRBm6-B13/1N/003-G/A	177847	1/60
16/003	FRBm6-B16/1N/003-G/A	177848	1/60
20/003	FRBm6-B20/1N/003-G/A	177849	1/60
25/003	FRBm6-B25/1N/003-G/A	177850	1/60
32/003	FRBm6-B32/1N/003-G/A	177851	1/60
40/003	FRBm6-B40/1N/003-G/A	177852	1/60

SG03013



Characteristic C

13/003	FRBm6-C13/1N/003-G/A	177853	1/60
16/003	FRBm6-C16/1N/003-G/A	177854	1/60
20/003	FRBm6-C20/1N/003-G/A	177855	1/60
25/003	FRBm6-C25/1N/003-G/A	177856	1/60
32/003	FRBm6-C32/1N/003-G/A	177857	1/60
40/003	FRBm6-C40/1N/003-G/A	177858	1/60

SG03013



Characteristic D

13/003	FRBm6-D13/1N/003-G/A	177859	1/60
16/003	FRBm6-D16/1N/003-G/A	177860	1/60
20/003	FRBm6-D20/1N/003-G/A	177861	1/60

Specifications | Combined RCD/MCB Devices FRBm., 1+N-poles

Description

- Combined RCD/MCB device
- Line voltage-independent tripping
- Compatible with standard busbar
- Twin-purpose terminal (lift/open-mouthed) above and below
- Busbar positioning optionally above or below
- Free terminal space despite installed busbar
- Guide for secure terminal connection
- Contact position indicator red - green
- Comprehensive range of accessories suitable for subsequent installation
- Nameplate
- The test key "T" must be pressed every 6 months. The system operator must be informed of this obligation and his responsibility in a way that can be proven. Under special conditions (e.g. damply and/or dusty environments, environments with polluting and/or corroding conditions, environments with large temperature fluctuations, installations with a risk of overvoltages due to switching of equipment and/or atmospheric discharges, portable equipment ...), it's recommended to test in monthly intervals.
- Pressing the test key "T" serves the only purpose of function testing the residual current device (RCD). This test does not make earthing resistance measurement (R_E), or proper checking of the earth conductor condition redundant, which must be performed separately.
- **Type -A:** Protects against special forms of residual pulsating DC which have not been smoothed.
- **Type -G:** High reliability against unwanted tripping. Suitable for any circuit where personal injury or damage to property may occur in case of unwanted tripping.
- **Type -F:** Increased protection in applications with 1phase frequency converter due to the detection of mixed frequencies, higher load capacity with smooth DC fault currents up to 10 mA.

Accessories:

Auxiliary switch for subsequent installation	ZP-IHK	286052
	ZP-WHK	286053
Tripping signal switch for subsequent installation	ZP-NHK	248437
Shunt trip release	ZP-ASA/..	248438, 248439
Tripping module	Z-KAM	248294
Terminal cover 2-poles	Z-TC/SD-2P	178099

Technical Data

		FRBm., 1+N-poles	
Electrical			
Design according to		IEC/EN 61009	
Classified according to		IEC 61373, EN 45545-2	
Current test marks as printed onto the device			
Tripping line voltage-independent		instantaneous 250A (8/20µs), surge current-proof	
Type G, F		10 ms delay 3kA (8/20µs), surge current-proof	
Rated voltage	U_n	240 V AC, 50 Hz AC, A types: 50/60 Hz	
Rated tripping current	$I_{\Delta n}$	10, 30, 100, 300 mA	
Rated non-tripping current	$I_{\Delta no}$	0.5 $I_{\Delta n}$	
Sensitivity		AC and pulsating DC	
Selectivity class		3	
FRBm6	Rated short circuit capacity		
	acc. to IEC/EN 61009	I_{cn}	6 kA
	acc. to IEC/EN 60947-2: 2A...20A	I_{cu}	6 kA
		I_{cs}	6 kA
	acc. to IEC/EN 60947-2: 25A...40A	I_{cu}	6 kA
		I_{cs}	5 kA
		I_{cs}	5 kA
Rated current		2 - 40 A	
Rated impulse withstand voltage	U_{imp}	4 kV (1.2/50µs)	
Characteristic		B, C, D	
Maximum back-up fuse (short circuit protection)		100 A gL (>10 kA)	
Endurance			
	electrical components	≥ 4,000 operating cycles	
	mechanical components	≥ 10,000 operating cycles	
Mechanical			
Frame size		45 mm	
Device height		80 mm	
Device width		35 mm (2MU)	
Mounting		3-position DIN rail clip, permits removal from existing busbar system	
Degree of protection switch		IP20	
Degree of protection, built-in		IP40	
Upper and lower terminals		open mouthed/lift terminals	
Terminal protection		finger and hand touch safe, DGVV V3, EN 50274	
Terminal capacity		1 - 25 mm ²	
Terminal torque		2 - 2.4 Nm	
Busbar thickness		0.8 - 2 mm	
Operation temperature		-25°C to +40°C	
Storage- and transport temperature		-35°C to +70°C	
Resistance to climatic conditions		acc. to IEC 60068-2-30 (25..55°C / 90..95% RH)	

Connection diagram

1+N-poles

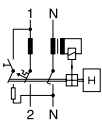

Dimensions (mm)

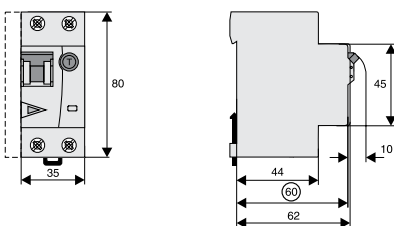

Anschluss von Ringkabelschuhen (nur FRB...RT)

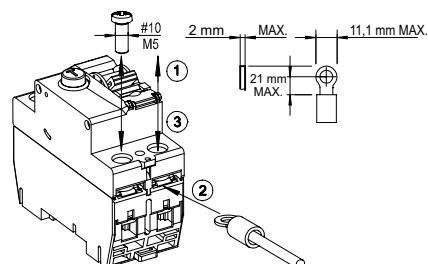

Tripping Characteristic FRBm-./1N/, Characteristics B, C and D

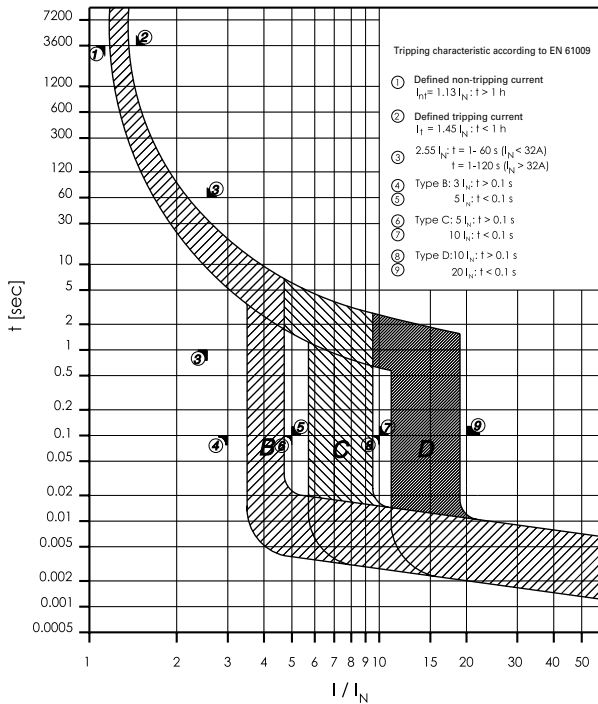

Effect of ambient temperature FRBm-./1N/

Effect of ambient temperature (MCB component)

I_n [A]	Ambient Temperature T [°C]										
	-25	-15	-5	10	30	40	45	55	60	65	70
2	2.3	2.3	2.2	2.1	2	1.9	1.9	1.8	1.7	1.7	1.6
4	4.8	4.7	4.5	4.3	4	3.8	3.7	3.6	3.5	3.4	3.3
6	7.0	6.8	6.6	6.4	6	5.7	5.6	5.3	5.2	5.1	4.9
10	12.3	11.9	11.4	10.8	10	9.5	9.3	8.8	8.6	8.4	8.1
13	15.1	14.7	14.3	13.7	13	12.5	12.3	11.8	11.6	11.3	11.1
16	19.1	18.6	18.0	17.1	16	15.2	14.9	14.1	13.8	13.4	13.0
20	24.8	23.9	23.0	21.7	20	19.0	18.5	17.5	17.0	16.5	16.1
25	31.4	30.2	29.1	27.3	25	23.9	23.3	22.1	21.6	21.1	20.4
32	40.1	38.6	37.1	34.9	32	30.4	29.6	28.0	27.3	26.5	25.7
40	51.0	49.0	47.0	44.0	40	38.1	37.1	35.1	34.1	33.1	32.1

SG02913



Description

- High-quality residual current device / miniature circuit breaker combination, line voltage-independent
- Increased protection in applications with 1-phase frequency converter due to the detection of mixed frequencies (type F)
- Reduction of nuisance tripping (type F or G/A) thanks to
 - time delayed tripping
 - increased current withstand capability (3 kA)
- Higher load rating with DC residual currents up to 10 mA (type F)
- Contact position indicator red - green
- Fault current tripping indicator white - blue
- Guide for secure terminal connection
- 3-position DIN rail clip, permits removal from existing busbar system
- Comprehensive range of accessories suitable for subsequent installation
- Wide variety of rated tripping currents
- Rated currents up to 40 A
- Tripping characteristics B, C
- Rated breaking capacity 10 kA and 6 kA
- Classified for the use in rail rolling stock

$I_n/I_{\Delta n}$
(A)

Type
Designation

Article No. Units per
package

Type F

6 kA, 2-poles

Sensitive to residual pulsating DC, surge current proof 3000 A, Type F  

SG02913



Characteristic B

32/0.03	FRBm6-B32/2/003-F	196981	1/60
40/0.03	FRBm6-B40/2/003-F	196982	1/60

SG02913



Characteristic C

32/0.03	FRBm6-C32/2/003-F	196973	1/60
40/0.03	FRBm6-C40/2/003-F	196974	1/60

Type G/A

6 kA, 2-poles

Sensitive to residual pulsating DC, surge current proof 3000 A, Type G/A 

SG02913



Characteristic B

32/0.03	FRBm6-B32/2/003-G/A	196965	1/60
40/0.03	FRBm6-B40/2/003-G/A	196966	1/60

SG02913



Characteristic C

32/0.03	FRBm6-C32/2/003-G/A	196957	1/60
40/0.03	FRBm6-C40/2/003-G/A	196958	1/60

$I_n/I_{\Delta n}$ (A)	Type Designation	Article No.	Units per package
---------------------------	---------------------	-------------	----------------------

Type Super A

6 kA, 2-poles

Conditionally surge current-proof 250 A, sensitive to residual pulsating DC, short-time delayed, Type Super A 

SG02913



Characteristic B

32/0.03	FRBm6-B32/2/003-LiA	170891	1/60
40/0.03	FRBm6-B40/2/003-LiA	170718	1/60
32/0.1	FRBm6-B32/2/01-LiA	170815	1/60
40/0.1	FRBm6-B40/2/01-LiA	170816	1/60

SG02913



Characteristic C

32/0.03	FRBm6-C32/2/003-LiA	170801	1/60
40/0.03	FRBm6-C40/2/003-LiA	170802	1/60
32/0.1	FRBm6-C32/2/01-LiA	170835	1/60
40/0.1	FRBm6-C40/2/01-LiA	170836	1/60

Type A

6 kA, 2-poles

Conditionally surge current-proof 250 A, sensitive to residual pulsating DC, Type A 

SG02913



Characteristic B

32/0.03	FRBm6-B32/2/003-A	170884	1/60
40/0.03	FRBm6-B40/2/003-A	170885	1/60
32/0.1	FRBm6-B32/2/01-A	170808	1/60
40/0.1	FRBm6-B40/2/01-A	170809	1/60
32/0.3	FRBm6-B32/2/03-A	170849	1/60
40/0.3	FRBm6-B40/2/03-A	170850	1/60

SG02913



Characteristic C

32/0.03	FRBm6-C32/2/003-A	170791	1/60
40/0.03	FRBm6-C40/2/003-A	170792	1/60
32/0.1	FRBm6-C32/2/01-A	170825	1/60
40/0.1	FRBm6-C40/2/01-A	170826	1/60
32/0.3	FRBm6-C32/2/03-A	170731	1/60
40/0.3	FRBm6-C40/2/03-A	170732	1/60

$I_n/I_{\Delta n}$
(A)

Type
Designation

Article No. Units per
package

Type AC

6 kA, 2-poles

Conditionally surge current-proof 250 A, Type AC 

SG02913



Characteristic B

32/0.03	FRBm6-B32/2/003	170877	1/60
40/0.03	FRBm6-B40/2/003	170878	1/60
32/0.3	FRBm6-B32/2/03	170842	1/60
40/0.3	FRBm6-B40/2/03	170843	1/60

SG02913



Characteristic C

32/0.03	FRBm6-C32/2/003	170727	1/60
40/0.03	FRBm6-C40/2/003	170728	1/60
32/0.3	FRBm6-C32/2/03	170859	1/60
40/0.3	FRBm6-C40/2/03	170860	1/60

Specifications | Combined RCD/MCB Devices FRBm6, 2-poles

Description

- Combined RCD/MCB device
- Line voltage-independent tripping
- Compatible with standard busbar
- Twin-purpose terminal (lift/open-mouthed) above and below
- Busbar positioning optionally above or below
- Free terminal space despite installed busbar
- Guide for secure terminal connection
- Contact position indicator red - green
- Fault current tripping indicator white - blue
- Comprehensive range of accessories suitable for subsequent installation
- The test key "T" must be pressed every 6 months. The system operator must be informed of this obligation and his responsibility in a way that can be proven. Under special conditions (e.g. damply and/or dusty environments, environments with polluting and/or corroding conditions, environments with large temperature fluctuations, installations with a risk of overvoltages due to switching of equipment and/or atmospheric discharges, portable equipment ...), it's recommended to test in monthly intervals.
- Pressing the test key "T" serves the only purpose of function testing the residual current device (RCD). This test does not make earthing resistance measurement (R_E), or proper checking of the earth conductor condition redundant, which must be performed separately.
- **Type -A:** Protects against special forms of residual pulsating DC which have not been smoothed.
- **Type -Super A:** High reliability against unwanted tripping. Suitable for any circuit where personal injury or damage to property may occur in case of unwanted tripping.
- **Type -G/A:** High reliability against unwanted tripping. Suitable for any circuit where personal injury or damage to property may occur in case of unwanted tripping. Additionally protects against special forms of residual pulsating DC which have not been smoothed.
- **Type -F:** Sensitive to pulsating DC residual current and detection of multifrequency residual currents up to 1 kHz
 - Increased protection due to the detection of mixed frequencies
 - Higher load rating with DC residual currents up to 10mA
 - Reduction of nuisance tripping thanks to time delayed tripping and increased current withstand capability of 3 kA
 Recommended for washing machines, dish washers, or motor applications with single-phase drives.

Accessories:

Auxiliary switch for subsequent installation	ZP-IHK	286052
	ZP-WHK	286053
Tripping signal switch for subsequent installation	ZP-NHK	248437
Shunt trip release	ZP-ASA/..	248438, 248439
Terminal cover 2-poles	Z-TC/SD-2P	178099

Technical Data

		FRBm6, 2-poles
Electrical		
Design according to		IEC/EN 61009 Type G according to ÖVE E 8601 IEC 61373, EN 45545-2
Classified according to		
Current test marks as printed onto the device		
Tripping line voltage-independent		instantaneous tripping, conditional surge current proof 250 A (8/20 µs) surge current proof 3 kA (8/20 µs) (F, -G/A)
Rated voltage	U_n	240 V AC, 50 Hz
Rated tripping current	$I_{\Delta n}$	30, 100, 300 mA
Rated non-tripping current	$I_{\Delta no}$	$0.5 I_{\Delta n}$
Sensitivity		AC and pulsating DC, Type F according to IEC/EN 62423
Selectivity class		3
Rated short circuit capacity	I_{cn}	6 kA
FRBm6		
Rated current		6 - 40 A
Rated impulse withstand voltage	U_{imp}	4 kV (1.2/50µs)
Characteristic		B, C
Maximum back-up fuse (short circuit protection)		100 A gL (>10 kA)
Endurance		
electrical components		≥ 4,000 operating cycles
mechanical components		≥ 10,000 operating cycles
Mechanical		
Frame size		45 mm
Device height		80 mm
Device width		35 mm (2MU)
Mounting		3-position DIN rail clip, permits removal from existing busbar system
Degree of protection switch		IP20
Degree of protection, built-in		IP40
Upper and lower terminals		open mouthed/lift terminals
Terminal protection		finger and hand touch safe, DGUV VS3, EN 50274
Terminal capacity		1 - 25 mm ²
Terminal torque		2 - 2.4 Nm
Busbar thickness		0.8 - 2 mm
Operation temperature		-25°C to +40°C
Storage- and transport temperature		-35°C to +60°C
Resistance to climatic conditions		acc. to IEC 60068-2-30 (25..55°C / 90..95% RH)

Connection diagram

2-poles

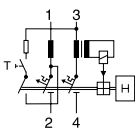

Dimensions (mm)

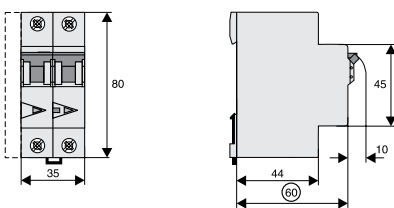

Tripping Characteristic FRBm. 2-poles, Characteristics B and C

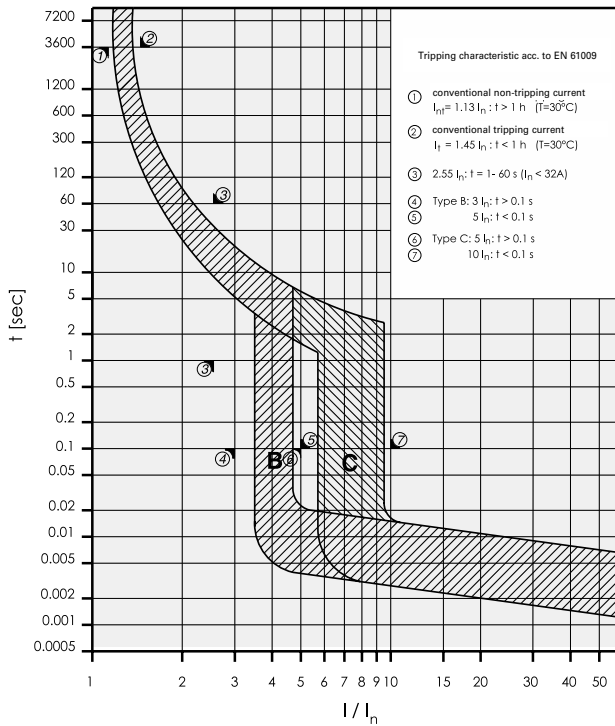

Internal Resistance FRBm6 2-poles

Type B/C	
At room temperature (single pole)	
I_n [A]	R^* [mΩ]
10	36.1
13	25.9
16	18.6
20	14.2
25	8.0
32	7.3
40	5.6

* 50Hz

Power Loss at I_n FRBm6 2-poles

Type B/C	
(entire unit)	
I_n [A]	P^* [W]
10	4.1
13	5.2
16	5.7
20	7.0
25	5.6
32	8.7
40	10.9

* 50Hz and ambient temperature

FRBm6: Influence of ambient temperature on load carrying capacity

- Values = max. allowed current in Ampere at the specific temperature
- Temperature factor (%/K) = 0.5

I _n [A]	Ambient temperature / °C									
	-40	-30	-25	-20	-10	0	10	20	30	40
25	33.8	32.5	31.9	31.3	30.0	28.8	27.5	26.3	25.0	23.8
32	43.2	41.6	40.8	40.0	38.4	36.8	35.2	33.6	32.0	30.4
40	54.0	52.0	51.0	50.0	48.0	46.0	44.0	42.0	40.0	38.0

Let-through Energy FRBm6 2-poles

Let-through Energy FRBm6, Characteristic B, 2polig

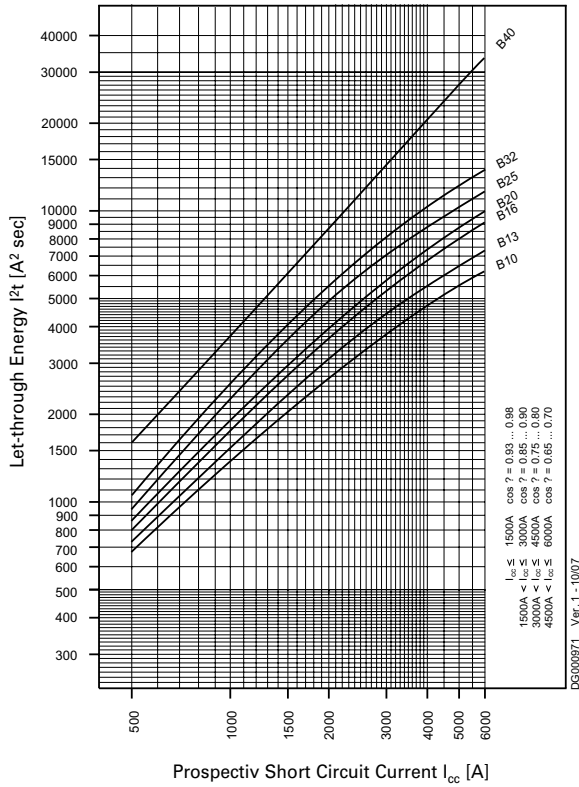

Let-through Energy FRBm6, Characteristic C, 2polig

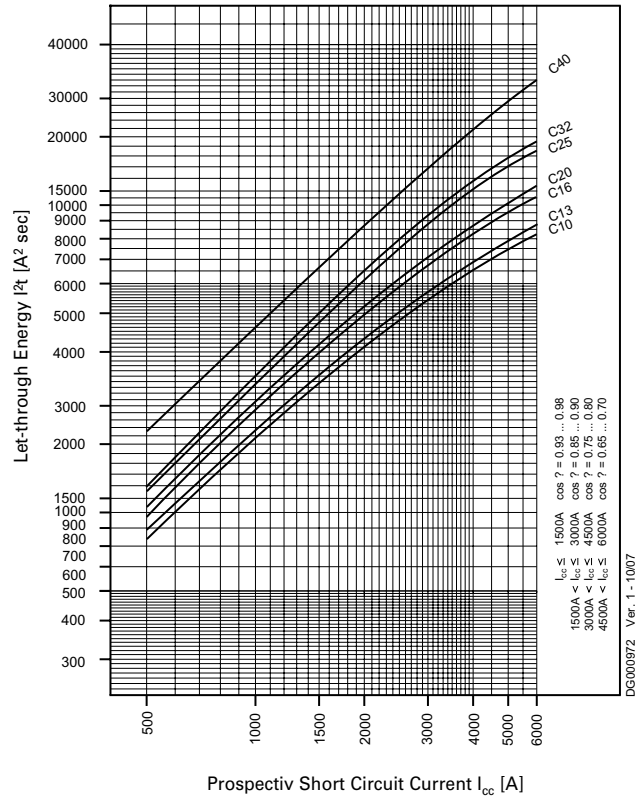

Let-through Current FRBm6 2-poles

Characteristic B

230V

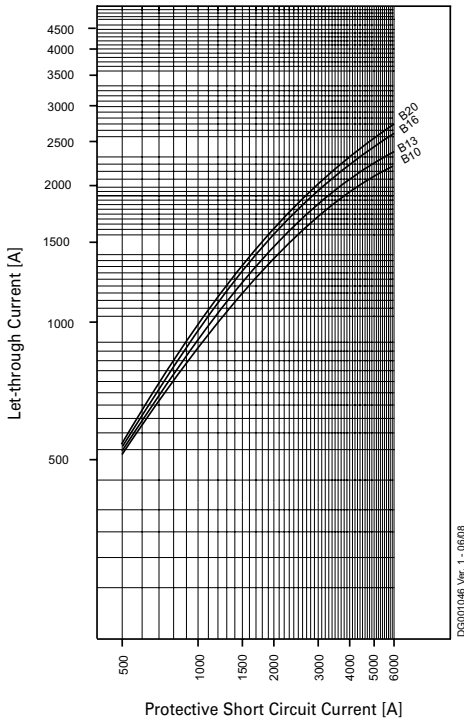

Characteristic C

230V

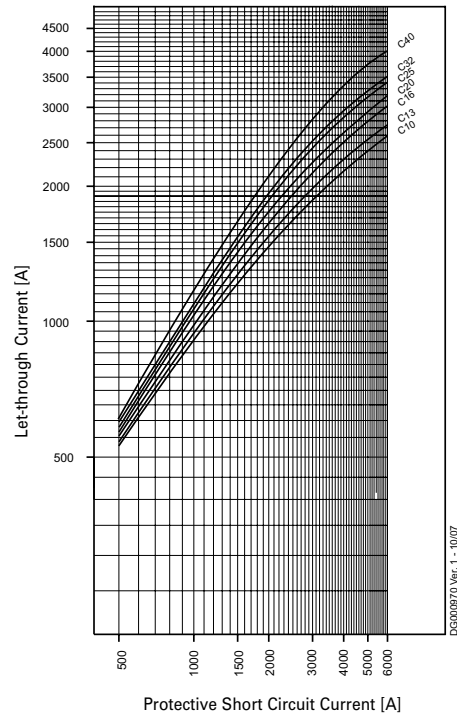

FRBm6 2-poles and NZM1/NZM2

Short circuit currents in kA, rated currents of fuses in A.

Overload and short-circuit release unit NZM at max. value

FRBm6	NZMB(C)(N)(H)1-A...					
	$I_{cu} = 25 (36)(50)(100) \text{ kA}$					
	40	50	63	80	100	125
B10	1	1.3	1.6	1.6	3.5	6
B13	0.9	1.3	1.6	1.6	3.5	6
B16	0.9	1	1.5	1.6	2.5	6
B20	0.6	1	1.3	1.3	2.5	6
B25	0.6	1	1.3	1.3	2.5	6
B32	-	1	0.9	1.3	1.6	5
B40	-	-	0.9	1.3	1.6	4.3
C10	1	1.3	1.6	1.6	3.5	6
C13	0.9	1.3	1.6	1.6	3.5	6
C16	0.9	1	1.5	1.6	2.5	6
C20	0.6	1	1.3	1.3	2.5	6
C25	0.6	1	1.3	1.3	2.5	6
C32	-	1	0.9	1.3	1.6	5
C40	-	-	0.9	1.3	1.6	4.3

FRBm6	NZMB(C)(N)(H)2-A...									
	$I_{cu} = 25 (36)(50)(150) \text{ kA}$									
	40	50	63	80	100	125	160	200	250	
B10	0.9	1.3	2.5	2.5	6	6	6	6	6	
B13	0.9	1	1.6	2.5	6	6	6	6	6	
B16	0.9	1	1.3	2.1	6	6	6	6	6	
B20	0.9	1	1.3	1.3	6	6	6	6	6	
B25	0.6	0.9	1.3	1.6	6	6	6	6	6	
B32	-	0.9	1.3	1.6	6	6	6	6	6	
B40	-	-	1	1.3	5	5	5	5	6	
C10	0.9	1.3	2.5	2.5	6	6	6	6	6	
C13	0.9	1	1.6	2.5	6	6	6	6	6	
C16	0.9	1	1.3	2.1	6	6	6	6	6	
C20	0.9	1	1.3	1.3	6	6	6	6	6	
C25	0.6	0.9	1.3	1.6	6	6	6	6	6	
C32	-	0.9	1.3	1.6	6	6	6	6	6	
C40	-	-	1	1.3	5	5	5	5	6	

FRBm6 2-poles and PLSM-OV/PLHT-OV

Short circuit currents in kA, rated currents of fuses in A.

FRBm6	PLSM-OV/PLHT-OV						
	$I_{cu} = 10 \text{ kA}$						
	25	32	40	50	56	63	80
B+C10	1.5	1.5	1.5	1.5	1.5	1.5	1.5
B+C13	1.5	1.5	1.5	1.5	1.5	1.5	1.5
B+C16	1.5	1.5	1.5	1.5	1.5	1.5	1.5
B+C20	-	1.5	1.5	1.5	1.5	1.5	1.5
B+C25	-	-	1.5	1.5	1.5	1.5	1.5
B+C32	-	-	-	1.5	1.5	1.5	1.5
B+C40	-	-	-	-	1.5	1.5	1.5

FRBm6 2-poles and Neozed¹⁾ / Diazed²⁾ / NH00³⁾

Short circuit currents in kA, Rated currents of fuses in A

Short-circuit Selectivity **FRBm6** towards fuse link **Neozed** ¹⁾

FRBm6	Neozed ¹⁾									
	16	20	25	32	35	40	50	63	80	100
B25	-	-	-	1,2	1,3	1,8	3,1	4,7	6	6
B32	-	-	-	-	1,2	1,7	2,7	3,8	5,5	6
B40	-	-	-	-	-	1,3	1,7	2,2	2,7	4,2
C25	-	-	-	1,1	1,3	1,8	2,8	3,9	5,6	6
C32	-	-	-	-	1,2	1,7	2,6	3,6	5,1	6
C40	-	-	-	-	-	1,3	1,9	3,3	3,2	5,8

Short-circuit Selectivity **FRBm6** towards fuse link **Diazed** ¹⁾

FRBm6	Diazed ²⁾									
	16	20	25	32	35	50	63	80	100	
B25	-	-	-	1,1	1,5	2,4	5,5	6	6	
B32	-	-	-	-	1,4	2,1	4,3	6	6	
B40	-	-	-	-	-	1,4	2,4	2,9	5,1	
C25	-	-	-	1,1	1,5	2,3	4,4	6	6	
C32	-	-	-	-	1,4	2,2	4,1	5,6	6	
C40	-	-	-	-	-	1,6	2,8	3,6	6	

Short-circuit Selectivity **FRBm6** towards fuse link **NH00** ³⁾

FRBm6	NH00 ³⁾											
	16	20	25	32	35	40	50	63	80	100	125	160
B25	-	-	-	0,9	1,2	1,6	2,4	3,4	5,5	6	6	6
B32	-	-	-	-	1,1	1,4	2,1	2,9	4,3	6	6	6
B40	-	-	-	-	-	-	1,4	1,9	2,8	4,1	6	6
C25	-	-	-	0,9	1,2	1,6	2,3	3	4,6	6	6	6
C32	-	-	-	-	1,1	1,5	2,1	2,8	4,3	6	6	6
C40	-	-	-	-	-	-	1,5	2,1	3,1	5,4	6	6

¹⁾ SIEMENS Type 5SE2; Size: D01, D02, D03; Operating class gG; Rated voltage: AC 400 V/DC 250 V

²⁾ SIEMENS Type 5SB2, 5SB4, 5SC2; Size: DII, DIII, DIV; Operating class gG; Rated voltage: AC 500 V/DC 500 V

³⁾ SIEMENS Type 3NA3 8, 3NA6 8, 3NA7 8; Size: 000, 00; Operating class gG; Rated voltage: AC 500 V/DC 250 V

Back-up Protection FRBm6, 2-poles

The up-stream protective devices will protect the down-stream FRBm6 up to the short-circuit current specified.

FRBm6, 2-poles and NZM1

Short circuit currents in kA.

FRBm6	NZMB1-A...
IT-system U = 230 V	
B, C, D	
10	20
13	20
16	20
20	15
25	15
32	15
40	15

$U_e = 230\text{ V}$: I_{cu} (FRBm62) = 6 kA (acc. to IEC/EN 61009)

$U_e = 400/415\text{ V}$: I_{cu} (NZMB1) = 25 kA (acc. to IEC/EN 60947-2)

Short circuit currents in kA.

FRBm6	NZMN1-A...
IT-system U = 230 V	
B, C, D	
10	25
13	25
16	25
20	20
25	20
32	20
40	20

$U_e = 230\text{ V}$: I_{cu} (FRBm62) = 6 kA (acc. to IEC/EN 61009)

$U_e = 400/415\text{ V}$: I_{cu} (NZMN1) = 50 kA (acc. to IEC/EN 60947-2)

Backup tests acc. to IEC/EN 60947-2, app. A: $U = 1.05 U_e$, (O - t - CO)

Short circuit currents in kA.

FRBm6	NZMC1-A...
IT-system U = 230 V	
B, C, D	
10	20
13	20
16	20
20	20
25	20
32	20
40	20

$U_e = 230\text{ V}$: I_{cu} (FRBm62) = 6 kA (acc. to IEC/EN 61009)

$U_e = 400/415\text{ V}$: I_{cu} (NZMC1) = 36 kA (acc. to IEC/EN 60947-2)

Short circuit currents in kA.

FRBm6	NZMH1-A...
IT-system U = 230 V	
B, C, D	
10	20
13	20
16	20
20	15
25	15
32	15
40	15

$U_e = 230\text{ V}$: I_{cu} (FRBm62) = 6 kA (acc. to IEC/EN 61009)

$U_e = 400/415\text{ V}$: I_{cu} (NZMH1) = 100 kA (acc. to IEC/EN 60947-2)

FRBm6 2-poles and NZM2

Short circuit currents in kA.

FRBm6	NZMB2-A...
IT-system U = 230 V	
B, C, D	
10	20
13	20
16	20
20	15
25	15
32	15
40	10

$U_e = 230\text{ V}$: I_{cu} (FRBm62) = 6 kA (acc. to IEC/EN 61009)

$U_e = 400/415\text{ V}$: I_{cu} (NZMB2) = 25 kA (acc. to IEC/EN 60947-2)

Short circuit currents in kA.

FRBm6	NZMN2-A...
IT-system U = 230 V	
B, C, D	
10	30
13	30
16	30
20	20
25	20
32	20
40	10

$U_e = 230\text{ V}$: I_{cu} (FRBm62) = 6 kA (acc. to IEC/EN 61009)

$U_e = 400/415\text{ V}$: I_{cu} (NZMN2) = 50 kA (acc. to IEC/EN 60947-2)

Backup tests acc. to IEC/EN 60947-2, app. A: $U = 1.05 U_e$, (O - t - CO)

Short circuit currents in kA.

FRBm6	NZMC2-A...
IT-system U = 230 V	
B, C, D	
10	25
13	25
16	25
20	20
25	20
32	20
40	10

$U_e = 230\text{ V}$: I_{cu} (FRBm62) = 6 kA (acc. to IEC/EN 61009)

$U_e = 400/415\text{ V}$: I_{cu} (NZMC2) = 36 kA (acc. to IEC/EN 60947-2)

Short circuit currents in kA.

FRBm6	NZMH2-A...
IT-system U = 230 V	
B, C, D	
10	30
13	30
16	30
20	25
25	25
32	25
40	10

$U_e = 230\text{ V}$: I_{cu} (FRBm62) = 6 kA (acc. to IEC/EN 61009)

$U_e = 400/415\text{ V}$: I_{cu} (NZMH2) = 100 kA (acc. to IEC/EN 60947-2)

FRBm6, 2-poles and LZM1

Short circuit currents in kA.

FRBm6	LZMB1-A... IT-system U = 230 V
B, C, D	
10	20
13	20
16	20
20	15
25	15
32	15
40	15

$U_e = 230\text{ V}$: I_{cu} (FRBm62) = 6 kA (acc. to IEC/EN 61009)
 $U_e = 400/415\text{ V}$: I_{cu} (LZMB1) = 25 kA (acc. to IEC/EN 60947-2)

Short circuit currents in kA.

FRBm6	LZMN1-A... IT-system U = 230 V
B, C, D	
10	25
13	25
16	25
20	20
25	20
32	20
40	20

$U_e = 230\text{ V}$: I_{cu} (FRBm62) = 6 kA (acc. to IEC/EN 61009)
 $U_e = 400/415\text{ V}$: I_{cu} (LZMN1) = 50 kA (acc. to IEC/EN 60947-2)

Backup tests acc. to IEC/EN 60947-2, app. A: $U = 1.05 U_e$, (O - t - CO)

Short circuit currents in kA.

FRBm6	LZMC1-A... IT-system U = 230 V
B, C, D	
10	20
13	20
16	20
20	20
25	20
32	20
40	20

$U_e = 230\text{ V}$: I_{cu} (FRBm62) = 6 kA (acc. to IEC/EN 61009)
 $U_e = 400/415\text{ V}$: I_{cu} (LZMC1) = 36 kA (acc. to IEC/EN 60947-2)

Short circuit currents in kA.

FRBm6	LZMS1-A... IT-system U = 230 V
B, C, D	
10	30
13	30
16	30
20	20
25	20
32	20
40	20

$U_e = 230\text{ V}$: I_{cu} (FRBm62) = 6 kA (acc. to IEC/EN 61009)
 $U_e = 400/415\text{ V}$: I_{cu} (LZMS1) = 70 kA (acc. to IEC/EN 60947-2)

FRBm6 2-poles and LZM2

Short circuit currents in kA.

FRBm6	LZMB2-A... IT-system U = 230 V
B, C, D	
10	20
13	20
16	20
20	15
25	15
32	15
40	10

$U_e = 230\text{ V}$: I_{cu} (FRBm62) = 6 kA (acc. to IEC/EN 61009)
 $U_e = 400/415\text{ V}$: I_{cu} (LZMB2) = 25 kA (acc. to IEC/EN 60947-2)

Short circuit currents in kA.

FRBm6	LZMN2-A... IT-system U = 230 V
B, C, D	
10	25
13	25
16	25
20	20
25	20
32	20
40	20

$U_e = 230\text{ V}$: I_{cu} (FRBm62) = 6 kA (acc. to IEC/EN 61009)
 $U_e = 400/415\text{ V}$: I_{cu} (LZMN2) = 50 kA (acc. to IEC/EN 60947-2)

Backup tests acc. to IEC/EN 60947-2, app. A: $U = 1.05 U_e$, (O - t - CO)

Short circuit currents in kA.

FRBm6	LZMC2-A... IT-system U = 230 V
B, C, D	
10	20
13	20
16	20
20	20
25	20
32	20
40	20

$U_e = 230\text{ V}$: I_{cu} (FRBm62) = 6 kA (acc. to IEC/EN 61009)
 $U_e = 400/415\text{ V}$: I_{cu} (LZMC2) = 36 kA (acc. to IEC/EN 60947-2)

Short circuit currents in kA.

FRBm6	LZMS2-A... IT-system U = 230 V
B, C, D	
10	30
13	30
16	30
20	20
25	20
32	20
40	20

$U_e = 230\text{ V}$: I_{cu} (FRBm62) = 6 kA (acc. to IEC/EN 61009)
 $U_e = 400/415\text{ V}$: I_{cu} (LZMS2) = 70 kA (acc. to IEC/EN 60947-2)

FRBm6 2-poles and PLSM-OV, NH00 gG/gL

Short circuit currents in kA.

FRBm6	PLSM-OV63/2, 3, 4, 3N
	IT-system U = 230 V
B, C, D	
10	10
13	10
16	10
20	10
25	10
32	10
40	10

 $U_e = 230 \text{ V}$: I_{cu} (FRBm62) = 6 kA (acc. to IEC/EN 61009) $U_e = 230/400 \text{ V}$: I_{cn} PLSM-OV63) = 10 kA (acc. to IEC/EN 60947-2)

Short circuit currents in kA.

FRBm6	NH00 100 A gG/gL
	IT-system U = 230 V
B, C, D	
10	40
13	40
16	40
20	40
25	40
32	40
40	40

 $U_e = 230 \text{ V}$: I_{cu} (FRBm62) = 6 kA (acc. to IEC/EN 61009)

AC 500 V: (NH00 125A gG/gL) = 120 kA (acc. to IEC60269)

Backup tests acc. to IEC/EN 60947-2, app. A: $U = 1.05 U_e$, (O - t - CO)

SG02213



Description

- High-quality residual current device / miniature circuit breaker combination, line voltage-independent
- Contact position indicator red - green
- Fault current tripping indicator white - blue
- Guide for secure terminal connection
- 3-position DIN rail clip, permits removal from existing busbar system
- Comprehensive range of accessories suitable for subsequent installation
- Wide variety of rated tripping currents
- Rated currents up to 32 A
- Tripping characteristics B, C, D
- Rated breaking capacity 6 kA acc. to IEC/EN 61009 & IEC/EN 60947
- Classified for the use in rail rolling stock

$I_n/I_{\Delta n}$
(A)

Type
Designation

Article No.

Units per
package

Type A

6 kA, 3+N-poles

Conditionally surge current-proof 250 A, sensitive to residual pulsating DC, Type A 

SG02213



Characteristic B

$I_n/I_{\Delta n}$ (A)	Type Designation	Article No.	Units per package
13/0.03	FRBm6-B13/3N/003-A	170987	1/30
16/0.03	FRBm6-B16/3N/003-A	170988	1/30
13/0.1	FRBm6-B13/3N/01-A	170898	1/30
16/0.1	FRBm6-B16/3N/01-A	170899	1/30
13/0.3	FRBm6-B13/3N/03-A	170945	1/30
16/0.3	FRBm6-B16/3N/03-A	170946	1/30

SG02213



Characteristic C

$I_n/I_{\Delta n}$ (A)	Type Designation	Article No.	Units per package
6/0.03	FRBm6-C6/3N/003-A	170996	1/30
10/0.03	FRBm6-C10/3N/003-A	170997	1/30
13/0.03	FRBm6-C13/3N/003-A	170998	1/30
16/0.03	FRBm6-C16/3N/003-A	170999	1/30
6/0.1	FRBm6-C6/3N/01-A	170926	1/30
10/0.1	FRBm6-C10/3N/01-A	170927	1/30
13/0.1	FRBm6-C13/3N/01-A	170928	1/30
16/0.1	FRBm6-C16/3N/01-A	170929	1/30
6/0.3	FRBm6-C6/3N/03-A	170954	1/30
10/0.3	FRBm6-C10/3N/03-A	170955	1/30
13/0.3	FRBm6-C13/3N/03-A	170956	1/30
16/0.3	FRBm6-C16/3N/03-A	170957	1/30

SG02213



Characteristic D

$I_n/I_{\Delta n}$ (A)	Type Designation	Article No.	Units per package
6/0.03	FRBm6-D6/3N/003-A	171008	1/30
10/0.03	FRBm6-D10/3N/003-A	170892	1/30
13/0.03	FRBm6-D13/3N/003-A	170893	1/30
16/0.03	FRBm6-D16/3N/003-A	170894	1/30
6/0.1	FRBm6-D6/3N/01-A	170938	1/30
10/0.1	FRBm6-D10/3N/01-A	170939	1/30
13/0.1	FRBm6-D13/3N/01-A	170940	1/30
16/0.1	FRBm6-D16/3N/01-A	170941	1/30
6/0.3	FRBm6-D6/3N/03-A	170966	1/30
10/0.3	FRBm6-D10/3N/03-A	170967	1/30
13/0.3	FRBm6-D13/3N/03-A	170968	1/30
16/0.3	FRBm6-D16/3N/03-A	170969	1/30

$I_n/I_{\Delta n}$
(A)

Type
Designation

Article No. Units per
package

Type AC

6 kA, 3+N-poles

Conditionally surge current-proof 250 A, Type AC 

SG02213



Characteristic B

$I_n/I_{\Delta n}$ (A)	Type Designation	Article No.	Units per package
13/0.03	FRBm6-B13/3N/003	170985	1/30
16/0.03	FRBm6-B16/3N/003	170986	1/30
13/0.1	FRBm6-B13/3N/01	170896	1/30
16/0.1	FRBm6-B16/3N/01	170897	1/30
13/0.3	FRBm6-B13/3N/03	170943	1/30
16/0.3	FRBm6-B16/3N/03	170944	1/30

SG02213



Characteristic C

$I_n/I_{\Delta n}$ (A)	Type Designation	Article No.	Units per package
6/0.03	FRBm6-C6/3N/003	170989	1/30
10/0.03	FRBm6-C10/3N/003	170990	1/30
13/0.03	FRBm6-C13/3N/003	170991	1/30
16/0.03	FRBm6-C16/3N/003	170992	1/30
6/0.1	FRBm6-C6/3N/01	170900	1/30
10/0.1	FRBm6-C10/3N/01	170901	1/30
13/0.1	FRBm6-C13/3N/01	170902	1/30
16/0.1	FRBm6-C16/3N/01	170903	1/30
6/0.3	FRBm6-C6/3N/03	170947	1/30
10/0.3	FRBm6-C10/3N/03	170948	1/30
13/0.3	FRBm6-C13/3N/03	170949	1/30
16/0.3	FRBm6-C16/3N/03	170950	1/30

SG02213



Characteristic D

$I_n/I_{\Delta n}$ (A)	Type Designation	Article No.	Units per package
6/0.03	FRBm6-D6/3N/003	171003	1/30
10/0.03	FRBm6-D10/3N/003	171004	1/30
13/0.03	FRBm6-D13/3N/003	171005	1/30
16/0.03	FRBm6-D16/3N/003	171006	1/30
6/0.1	FRBm6-D6/3N/01	170933	1/30
10/0.1	FRBm6-D10/3N/01	170934	1/30
13/0.1	FRBm6-D13/3N/01	170935	1/30
16/0.1	FRBm6-D16/3N/01	170936	1/30
6/0.3	FRBm6-D6/3N/03	170961	1/30
10/0.3	FRBm6-D10/3N/03	170962	1/30
13/0.3	FRBm6-D13/3N/03	170963	1/30
16/0.3	FRBm6-D16/3N/03	170964	1/30

Specifications | Combined RCD/MCB Devices FRBm6, 3+N-poles

Description

- Combined RCD/MCB device
 - Line voltage-independent tripping
 - Compatible with standard busbar
 - Twin-purpose terminal (lift/open-mouthed) above and below
 - Busbar positioning optionally above or below
 - Free terminal space despite installed busbar
 - Guide for secure terminal connection
 - Contact position indicator red - green
 - Fault current tripping indicator white - blue
 - Comprehensive range of accessories suitable for subsequent installation
 - The test key "T" must be pressed every 6 months. The system operator must be informed of this obligation and his responsibility in a way that can be proven. Under special conditions (e.g. damply and/or dusty environments, environments with polluting and/or corroding conditions, environments with large temperature fluctuations, installations with a risk of overvoltages due to switching of equipment and/or atmospheric discharges, portable equipment ...), it's recommended to test in monthly intervals.
 - Pressing the test key "T" serves the only purpose of function testing the residual current device (RCD). This test does not make earthing resistance measurement (R_E), or proper checking of the earth conductor condition redundant, which must be performed separately.
- **Type -A:** Protects against special forms of residual pulsating DC which have not been smoothed.

Accessories:

Auxiliary switch for subsequent installation	ZP-IHK	286052
	ZP-WHK	286053
Tripping signal switch for subsequent installation	ZP-NHK	248437
Shunt trip release	ZP-ASA/..	248438, 248439
Terminal cover 4-poles	Z-TC/SD-4P	178101

Technical Data

		FRBm6, 3+N-poles	
Electrical			
Design according to		IEC/EN 61009, IEC/EN 60947	
Classified according to		IEC 61373, EN 45545-2	
Current test marks as printed onto the device			
Tripping line voltage-independent		instantaneous 250A (8/20µs), surge current-proof, N protected	
Rated voltage	U_n	240/415V AC, 50Hz	
Rated tripping current	$I_{\Delta n}$	30, 100, 300 mA	
Rated non-tripping current	$I_{\Delta n0}$	0.5 $I_{\Delta n}$	
Sensitivity		AC and pulsating DC	
Selectivity class		3	
Rated short circuit capacity			
FRBm6 acc. to IEC/EN61009: 6A...16A	I_{cn}	6 kA	
acc. to IEC/EN60947-2: 6A...16A	I_{cu}	6 kA	
	I_{cs}	3 kA	
Rated current		6 - 32 A	
Rated impulse withstand voltage	U_{imp}	4 kV (1.2/50µs)	
Characteristic		B, C, D	
Maximum back-up fuse (short circuit protection)		100 A gL (>10 kA)	
Endurance			
electrical components		≥ 4,000 operating cycles	
mechanical components		≥ 10,000 operating cycles	
Mechanical			
Frame size		45 mm	
Device height		80 mm	
Device width		70 mm (4MU)	
Mounting		3-position DIN rail clip, permits removal from existing busbar system	
Degree of protection switch		IP20	
Degree of protection, built-in		IP40	
Upper and lower terminals		open mouthed/lift terminals	
Terminal protection		finger and hand touch safe, DGUV VS3, EN 50274	
Terminal capacity		1 - 25 mm ²	
Terminal torque		2 - 2.4 Nm	
Busbar thickness		0.8 - 2 mm	
Operation temperature		-25°C to +40°C	
Storage- and transport temperature		-35°C to +70°C	
Resistance to climatic conditions		acc. to IEC 68-2 (25..55°C / 90..95% RH)	

Connection diagram

3+N-poles

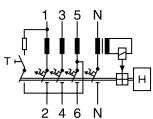

Dimensions (mm)

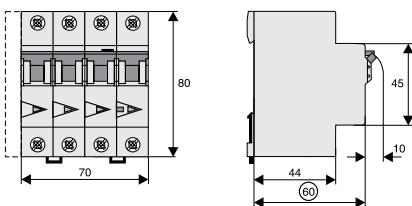

Tripping Characteristic FRBm. 3+N-poles, Characteristics B, C and D

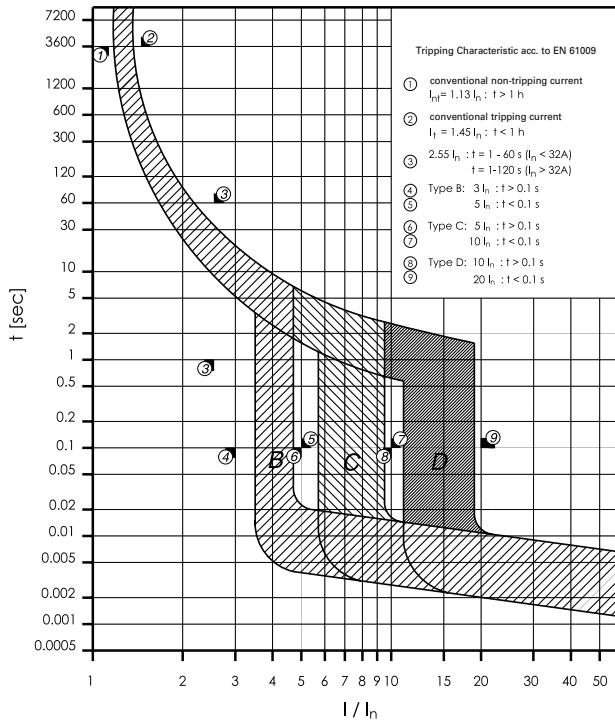

Internal Resistance FRBm. 3+N-poles

	Type B			Type C			Type D		
	L1, L2	L3	N	L1, L2	L3	N	L1, L2	L3	N
I_n [A]	R* [mΩ]	R* [mΩ]	R* [mΩ]	R* [mΩ]	R* [mΩ]	R* [mΩ]	R* [mΩ]	R* [mΩ]	R* [mΩ]
6	-	-	-	34.3	28.2	28.8	34.3	28.0	29.7
10	-	-	-	19.3	15.3	18.1	19.7	15.3	15.3
13	11.8	12.6	12.2	11.9	12.7	9.1	9.9	10.4	8.9
16	9.8	9.3	7.8	9.5	8.8	6.6	9.8	9.2	6.8
20	-	-	-	6.5	5.9	5.5	6.6	6.1	5.5
25	-	-	-	4.3	3.7	3.5	-	-	-

* 50Hz

Power Loss at I_n FRBm. 3+N-poles

(entire unit)	Type B	Type C	Type D	Ambient Temperature T [°C]											
				I_n [A]	-25	-15	-5	10	30	40	45	55	60	65	70
I_n [A]	P* [W]	P* [W]	P* [W]	6	7.7	7.4	7.1	6.6	6	5.7	5.6	5.2	5.1	4.9	4.8
6	-	4.8	4.8	10	12.6	12.1	11.6	10.9	10	9.5	9.3	8.8	8.6	8.3	8.1
10	-	8.2	7.8	13	16.8	16.1	15.4	14.4	13	12.4	12.1	11.4	11.0	10.7	10.3
13	10.2	9.4	7.7	16	19.8	19.1	18.4	17.4	16	15.3	14.9	14.2	13.9	13.5	13.2
16	11.6	10.9	11.2	20	24.8	23.9	23.1	21.7	20	19.1	18.6	17.8	17.3	16.9	16.4
20	-	11.8	12.0	25	32.9	31.4	30.1	27.8	25	23.5	22.7	21.3	20.6	19.8	19.1
25	-	11.6	-	32	40.2	38.7	37.2	35.0	32	30.5	29.7	28.2	27.5	26.7	26.0
32	-	15.6	-												

* 50Hz and ambient temperature

Back-up ProtectionFRBm6

The up-stream protective devices will protect the down-streamFRBm6 up to the short-circuit current specified.

FRBm and NZM1

Short circuit currents in kA.

FRBm4/ FRBm6	NZMB1(C1)(N1)(H1)-A...		
	U _e = 415 V		
	Type B	Type C	Type D
6	-	20	20
10	-	20	20
13	20	20	20
16	20	20	20
20	-	20	20
25	-	20	-

U_e = 415V: I_{cn} (FRBm4) = 4.5 kA (acc. to IEC/EN 61009)
 U_e = 415V: I_{cu} (FRBm6) = 6 kA (acc. to IEC/EN 61009)
 U_e = 400/415V: I_{cn} (NZMB1) = 25 kA (acc. to IEC/EN 60947-2)
 U_e = 400/415V: I_{cn} (NZMC1) = 36 kA (acc. to IEC/EN 60947-2)
 U_e = 400/415V: I_{cn} (NZMN1) = 50 kA (acc. to IEC/EN 60947-2)
 U_e = 400/415V: I_{cn} (NZMH1) = 100 kA (acc. to IEC/EN 60947-2)

FRBm and NZM2

Short circuit currents in kA.

FRBm4/ FRBm6	NZMB2(C2)(N2)(H2)-A...		
	U _e = 415 V		
	Type B	Type C	Type D
6	-	20	20
10	-	20	20
13	20	20	20
16	20	20	20
20	-	20	20
25	-	20	-

U_e = 415V: I_{cn} (FRBm4) = 4.5 kA (acc. to IEC/EN 61009)
 U_e = 415V: I_{cu} (FRBm6) = 6 kA (acc. to IEC/EN 61009)
 U_e = 400/415V: I_{cn} (NZMB2) = 25 kA (acc. to IEC/EN 60947-2)
 U_e = 400/415V: I_{cn} (NZMC2) = 36 kA (acc. to IEC/EN 60947-2)
 U_e = 400/415V: I_{cn} (NZMN2) = 50 kA (acc. to IEC/EN 60947-2)
 U_e = 400/415V: I_{cn} (NZMH2) = 150 kA (acc. to IEC/EN 60947-2)

FRBm6: Influence of ambient temperature on load carrying capacity

I _n [A]	Ambient temperature / °C											
	-25	-30	-5	10	30	40	45	50	55	60	65	70
6	7.7	7.4	7.1	6.6	6	5.7	5.6	5.4	5.2	5.1	4.9	4.8
10	12.6	12.1	11.6	10.9	10	9.5	9.3	9.1	8.8	8.6	8.3	8.1
13	16.8	16.1	15.4	14.4	13	12.4	12.0	11.7	11.4	11.0	10.7	10.3
16	19.8	19.1	18.4	17.4	16	15.3	14.9	14.6	14.2	13.9	13.5	13.2
20	24.8	23.9	23.0	21.7	20	19.1	18.6	18.2	17.8	17.3	16.9	16.4
25	32.9	31.4	30.0	27.8	25	23.5	22.7	22.0	21.3	20.6	19.8	19.1
32	40.2	38.7	37.2	35.0	32	30.5	29.7	29.0	28.2	27.5	26.7	26.0

Eaton's electrical business is a global leader with deep regional application expertise in power distribution and circuit protection; power quality, backup power and energy storage; control and automation; life safety and security; structural solutions; and harsh and hazardous environment solutions. Through end-to-end services, channel and an integrated digital platform & insights Eaton is powering what matters across industries and around the world, helping customers solve their most critical electrical power management challenges.

For more information, visit [Eaton.com](https://www.eaton.com).



Eaton Industries (Austria) GmbH
Scheydgasse 42
1210 Vienna
Austria

Eaton
EMEA Headquarters
Route de la Longeraie 7
1110 Morges, Switzerland

© 2022 Eaton
All Rights Reserved
Publication No. CA003015EN
Article number 301997-MK
May 2022

Changes to the products, to the information contained in this document, and to prices are reserved; as are errors and omissions. Only order confirmations and technical documentation by Eaton is binding. Photos and pictures also do not warrant a specific layout or functionality. Their use in whatever form is subject to prior approval by Eaton. The same applies to trademarks (especially Eaton, Moeller, and Cutler-Hammer). The Terms and Conditions of Eaton apply, as referenced on Eaton Internet pages and Eaton order confirmations.

Eaton is a registered trademark.

All other trademarks are property of their respective owners.

Follow us on social media to get the latest product and support information.

