

Approval body for construction products
and types of construction

Bautechnisches Prüfamt

An institution established by the Federal and
Laender Governments



European Technical Assessment

ETA-16/0123
of 25 April 2016

English translation prepared by DIBt - Original version in German language

General Part

Technical Assessment Body issuing the
European Technical Assessment:

Trade name of the construction product

Product family
to which the construction product belongs

Manufacturer

Manufacturing plant

This European Technical Assessment
contains

This European Technical Assessment is
issued in accordance with Regulation (EU)
No 305/2011, on the basis of

Deutsches Institut für Bautechnik

TSM high performance, TSM high performance A4, TSM
high performance HCR

Concrete screw size 5 and 6 mm for multiple use for non-
structural applications in concrete and in prestressed
hollow core slabs

TOGE Dübel GmbH & Co. KG
Illesheimer Straße 10
90431 Nürnberg
DEUTSCHLAND

TOGE Dübel GmbH & Co. KG

15 pages including 3 annexes which form an integral part
of this assessment

Guideline for European technical approval of "Metal
anchors for use in concrete", ETAG 001 Part 6: "Anchors
for multiple use for non-structural applications",
August 2010,
used as European Assessment Document (EAD)
according to Article 66 Paragraph 3 of Regulation (EU)
No 305/2011.

The European Technical Assessment is issued by the Technical Assessment Body in its official language. Translations of this European Technical Assessment in other languages shall fully correspond to the original issued document and shall be identified as such.

Communication of this European Technical Assessment, including transmission by electronic means, shall be in full. However, partial reproduction may only be made with the written consent of the issuing Technical Assessment Body. Any partial reproduction shall be identified as such.

This European Technical Assessment may be withdrawn by the issuing Technical Assessment Body, in particular pursuant to information by the Commission in accordance with Article 25(3) of Regulation (EU) No 305/2011.

Specific Part

1 Technical description of the product

The TOGE concrete screw TSM high performance in sizes of 5 and 6 mm is an anchor made of zinc-plated steel respectively steel with zinc flake coating and stainless steel. The anchor is screwed into a predrilled cylindrical drill hole. The special thread of the anchor cuts an internal thread into the member while setting. The anchorage is characterised by mechanical interlock in the special thread.

Product and product description is given in Annex A.

2 Specification of the intended use in accordance with the applicable European Assessment Document

The performances given in Section 3 are only valid if the anchor is used in compliance with the specifications and conditions given in Annex B.

The verifications and assessment methods on which this European Technical Assessment is based lead to the assumption of a working life of the anchor of at least 50 years. The indications given on the working life cannot be interpreted as a guarantee given by the producer, but are to be regarded only as a means for choosing the right products in relation to the expected economically reasonable working life of the works.

3 Performance of the product and references to the methods used for its assessment

3.1 Mechanical resistance and stability (BWR 1)

The essential characteristics regarding mechanical resistance and stability are included under the Basic Works Requirement Safety in use.

3.2 Safety in case of fire (BWR 2)

Essential characteristic	Performance
Reaction to fire	Anchorage satisfies requirements for Class A1
Resistance to fire	See Annex C 3

3.3 Safety in use (BWR 4)

Essential characteristic	Performance
Characteristic resistance for tension and shear loads as well as bending moments in concrete	See Annex C 1 and C 2
Edge distances and spacing	See Annex C 1

4 Assessment and verification of constancy of performance (AVCP) system applied, with reference to its legal base

In accordance with guideline for European technical approval ETAG 001, April 2013 used as European Assessment Document (EAD) according to Article 66 Paragraph 3 of Regulation (EU) No 305/2011 the applicable European legal act is: [97/161/EC].

The system to be applied is: 2+

5 Technical details necessary for the implementation of the AVCP system, as provided for in the applicable European Assessment Document

Technical details necessary for the implementation of the AVCP system are laid down in the control plan deposited at Deutsches Institut für Bautechnik.

Issued in Berlin on 25 April 2016 by Deutsches Institut für Bautechnik

Andreas Kummerow
p. p. Head of Department

beglaubigt:
Tempel

product and installed condition

Toge concrete screw TSM high performance TSM 5 and TSM 6

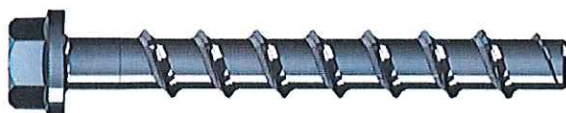

carbon steel



stainless steel A4 and HCR

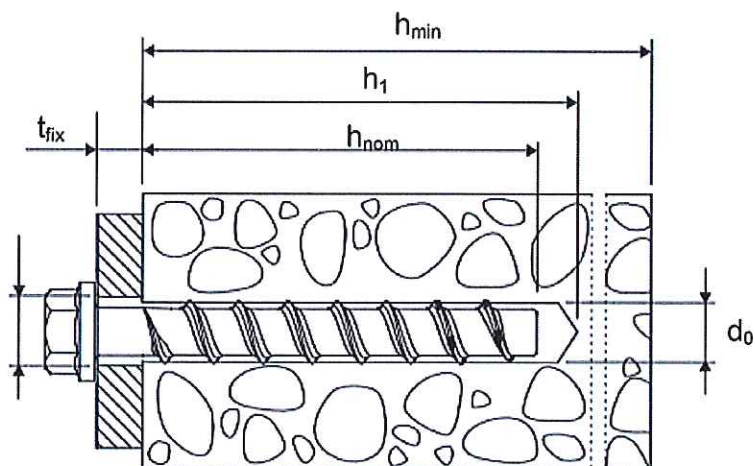

- d_0 = nominal drill bit diameter
- h_{nom} = nominal anchorage depth
- h_1 = depth of the drill hole
- h_{min} = minimum thickness of member
- t_{fix} = thickness of fixture

TOGE concrete screw TSM high performance

Product description

Installed condition

Annex A 1

installed condition in precast prestressed hollow core slabs

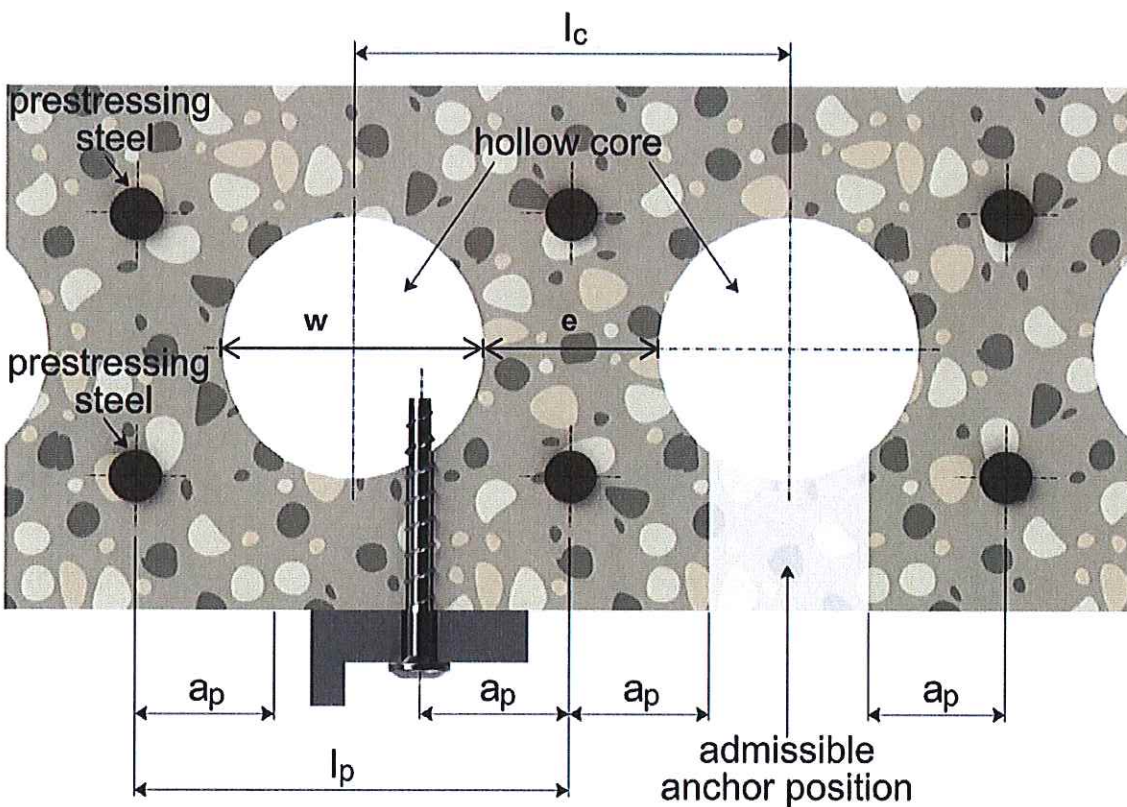

$$w / e \leq 4,2$$

w core width
e web thickness

core distance	l_c	≥ 100 mm
prestressing steel	l_p	≥ 100 mm
distance between anchor position and prestressing steel	a_p	≥ 50 mm

TOGE concrete screw TSM high performance























Product description

Installed condition

Annex A 2

Table A1: Materials and variants

part	name	Material		
1, 2, 3, 4, 5, 6, 7, 8, 9, 10, 11	Concrete screw	TSM high performance	Steel EN 10263-4 galvanized acc. To EN ISO 4042 or zinc flake coating acc. To EN ISO 10683 ($\geq 5\mu\text{m}$)	
		TSM high performance A4	1.4401, 1.4404, 1.4571, 1.4578	
		TSM high performance HCR	1.4529	
				TSM high performance TSM high performance A4 TSM high performance HCR
		nominal characteristic steel yield strength	f_{yk} [N/mm ²]	560
		nominal characteristic steel ultimate strength	f_{uk} [N/mm ²]	700
		elongation at rupture	A_5 [%]	≤ 8

		1)	Anchor version with connection thread and hexagon socket e.g. TSM 8x105 M10 SW5
		2)	Anchor version with connection thread and hexagon drive e.g. TSM 8x105 M10 SW7
		3)	Anchor version with washer, hexagon head and TORX e.g. TSM 8x80 SW13 VZ 40
		4)	Anchor version with washer and hexagon head e.g. TSM 8x80 SW13
		5)	Anchor version with washer, hexagon head and e.g. TSM 8x80 SW13 OS
		6)	Anchor version with countersunk head e.g. TSM 8x80 C VZ 40
		7)	Anchor version with pan head e.g. TSM 8x80 P VZ 40
		8)	Anchor version with large pan head e.g. TSM 8x80 LP VZ 40
		9)	Anchor version with countersunk head and connection thread e.g. TSM 6x55 AG M8
		10)	Anchor version with hexagon drive and connection thread e.g. TSM 6x55 M8 SW10
		11)	Anchor version with internal thread and hexagon drive e.g. TSM 6x55 IM M8/10





TOGE concrete screw TSM high performance

Product descriptions
Materials and variants

Annex A 3

Table A2: Dimensions and markings

Anchorsize			TSM 5	TSM 6
Length of the anchor	$L \leq$	[mm]	200	
Diameter of shaft	d_k	[mm]	4,0	5,1
Diameter of thread	d_s	[mm]	6,5	7,5

	<p>Marking: TSM high performance Anchor type: TSM Anchor size: 10 Length of the anchor: 100</p>	
	<p>TSM high performance A4 Anchor type: TSM Anchor size: 10 Length of the anchor: 100 Material: A4</p>	
	<p>TSM high performance HCR Anchor type: TSM Anchor size: 10 Length of the anchor: 100 Material: HCR</p>	
	<p>Marking "k" or "x" for anchors with connection thread and $h_{nom} = 35$ mm</p>	

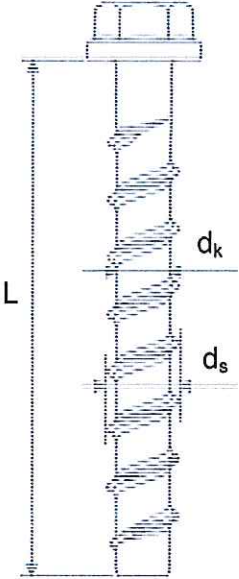

TOGE concrete screw TSM high performance

Product descriptions
Dimensions and markings

Annex A 4

Intended use

Anchorage subject to:

- static and quasi static loads
- Used only for multiple use for non structural application acc. to ETAG 001, Part 6: TSM 5, TSM 6
- Used for anchorages in prestressed hollow core slabs: TSM 6
- Used for anchorages with requirements related to resistance of fire (not for using in prestressed hollow core slabs): TSM 6

Base materials:

- reinforced and unreinforced concrete according to EN 206-1:2000
- strength classes C20/25 to C50/60 according to EN 206-1:2000
- cracked and uncracked concrete

Use conditions (Environmental conditions):

- The anchor may only be used in dry internal conditions: All screw types
- Structural subject to external atmospheric exposure (including industrial and marine environment) and to permanently damp internal condition no particular aggressive conditions exists: screw types made of stainless steel with marking A4
- Structural subject to external atmospheric exposure (including industrial and marine environment) and to permanently damp internal condition if particular aggressive conditions exists: screw types made of stainless steel with marking HCR

Note: Such particular aggressive conditions are e.g. permanent, alternating immersion in seawater or the splash zone of seawater, chloride atmosphere of indoor swimming pools or atmosphere with chemical pollution (e.g. in desulphurization plants or road tunnels where de-icing materials are used)

Design:

- Anchorages are designed under the responsibility of an engineer experienced in anchorages and concrete work.
- Verifiable calculation notes and drawings are prepared taking account of the loads to be anchored. The position of the anchor is indicated on the design drawings (e.g. position of the anchor relative to reinforcement or to supports, etc.).
- Anchorages under static or quasi-static actions are designed for design method A in accordance with:
 - ETAG 001, Annex C, Edition August 2010
 - CEN/TS 1992-4:2009.
- Anchorages under fire exposure are designed in accordance with
 - EOTA Technical Report TR 020, Edition May 2004
 - CEN/TS 1992-4:2009, Annex D (it must be ensured that local spalling of the concrete cover does not occur).

Installation:

- Hammer drilling only.
- Anchor installation carried out by appropriately qualified personal and under the supervision of the person responsible for technical matters of the site.
- After installation further turning of the anchor is not possible. The head of the anchor is supported on the fixture and is not damaged.

TOGE concrete screw TSM high performance

Intended use
Specifications

Annex B 1

Table B1: Installation parameters

Anchorsize		TSM 5	TSM 6	
Nominal embedment depth		$h_{nom} = 35 \text{ mm}$	$h_{nom} = 35 \text{ mm}$	$h_{nom} = 55 \text{ mm}$
nominal drill bit diameter	d_0 [mm]	5	6	
cutting diameter of drill bit	$d_{cut} \leq$ [mm]	5,40	6,40	
depth of drill hole	$h_1 \geq$ [mm]	40	40	60
Nominal embedment depth	$h_{nom} \geq$ [mm]	35	35	55
diameter of clearing hole in the fixture	$d_f \leq$ [mm]	7	8	
Installation torque	$T_{inst} \leq$ Nm	8	10	
Maximum nominal torque for installation with an impact screwdriver		[Nm]	120	150

Table B2: Minimum thickness of member, minimum edge distance and minimum spacing

Anchorsize		TSM 5	TSM 6	
Nominal embedment depth		$h_{nom} = 35 \text{ mm}$	$h_{nom} = 35 \text{ mm}$	$h_{nom} = 55 \text{ mm}$
minimum thickness of member	h_{min} [mm]	80	80	100
minimum edge distance	c_{min} [mm]	35	35	40
minimum spacing	s_{min} [mm]	35	35	40

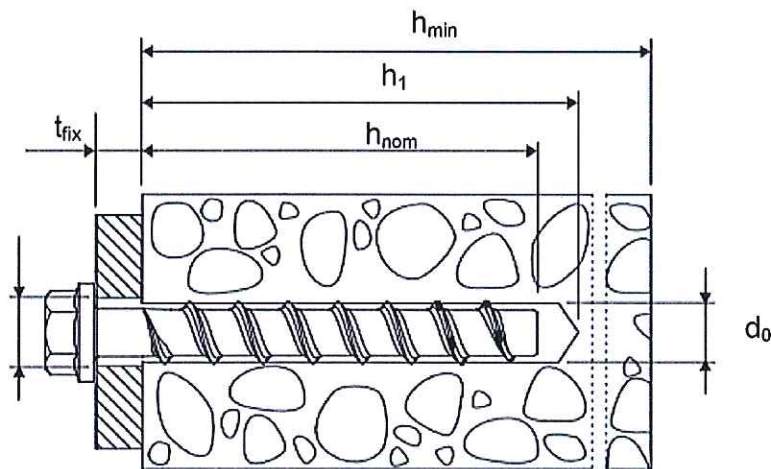

TOGE concrete screw TSM high performance

Intended use

Installation parameters

Annex B 2

Installation parameters for anchorages in precast prestressed hollow core slabs

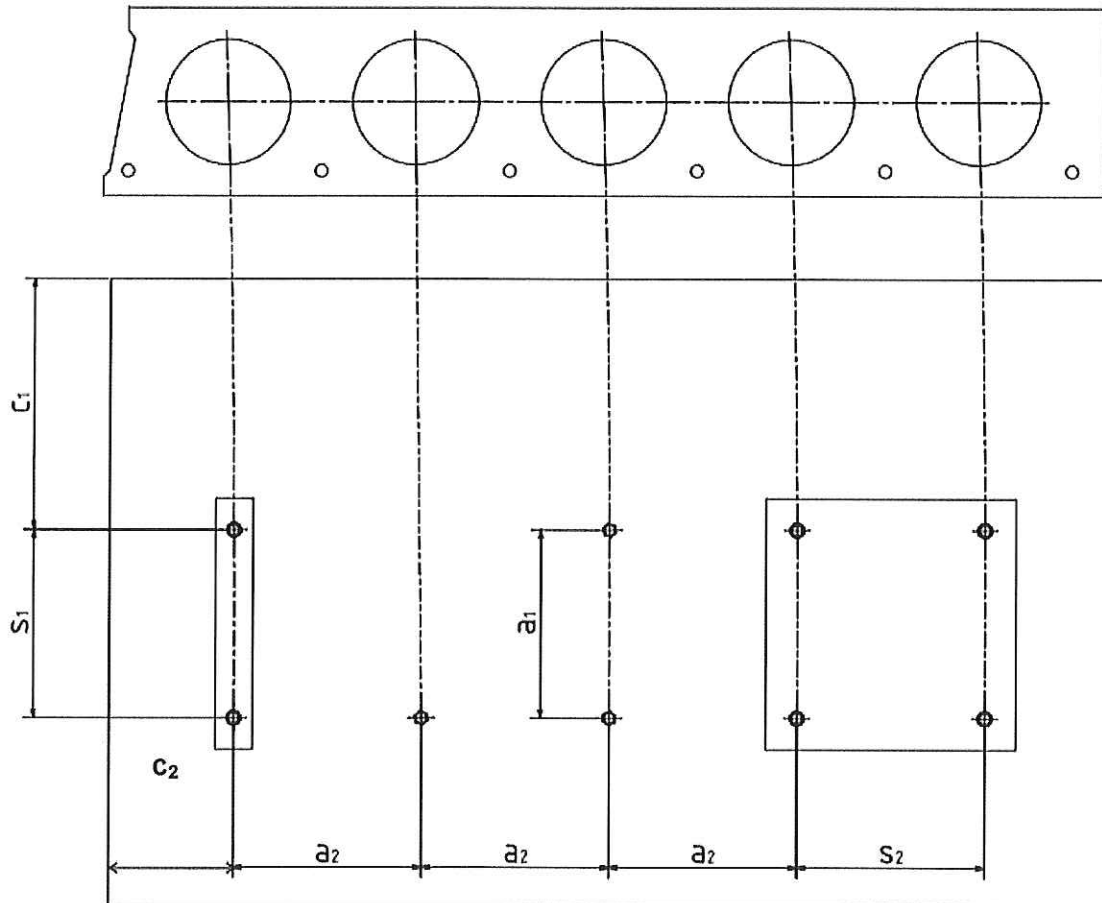

c_1, c_2 edge distance
 s_1, s_2 anchor spacing
 a_1, a_2 distance between anchor groups

Minimum edge distance $c_{min} \geq 100 \text{ mm}$

Minimum anchor spacing $s_{min} \geq 100 \text{ mm}$

Minimum distance between anchor groups $a_{min} \geq 100 \text{ mm}$

TOGE concrete screw TSM high performance

Intended use

Installation parameters for anchorages in precast prestressed hollow slabs

Annex B 3

Installation instructions

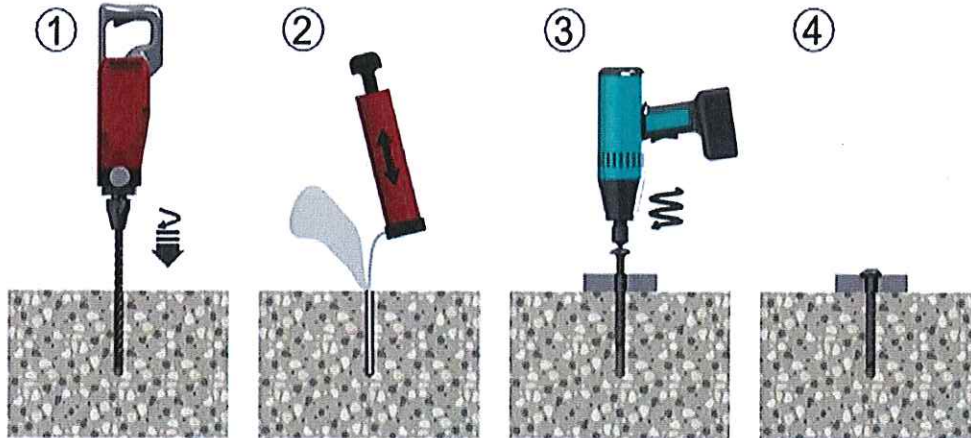

Installation instructions for anchorages in prestressed hollow slabs

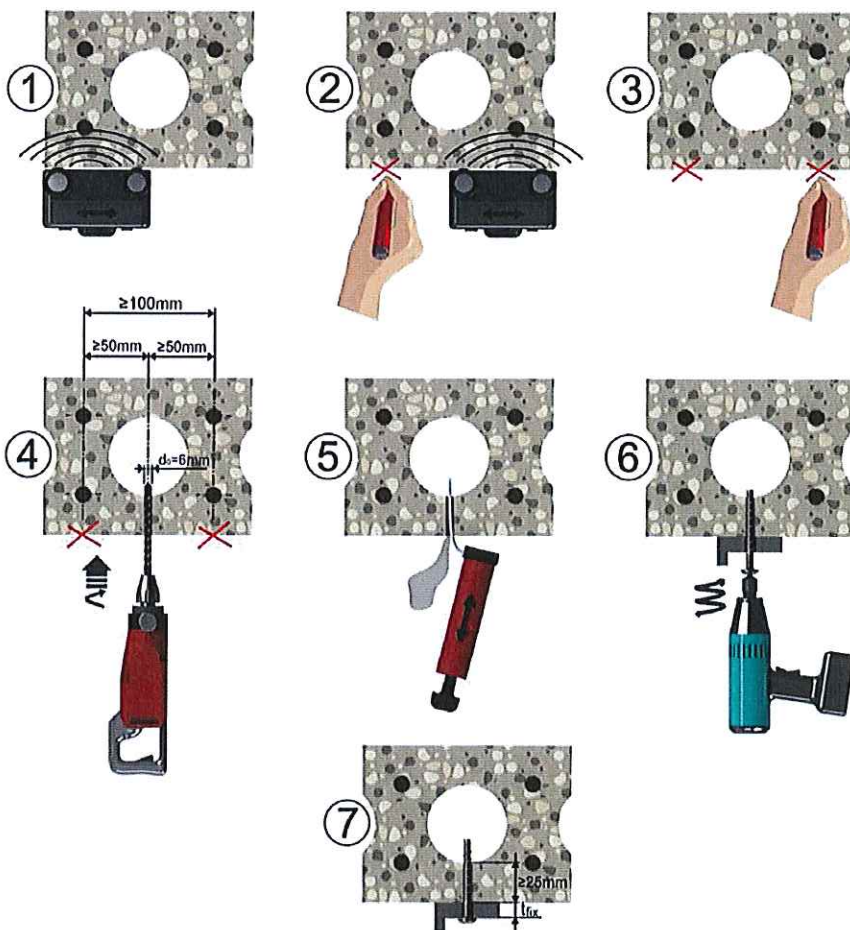

TOGE concrete screw TSM high performance

Intended use
Installation instructions

Annex B 4

**Table C1: Characteristic values for design method A according to ETAG 001, Annex C
or CEN/TS 1992-4**

Anchorsize			TSM 5		TSM 6	
Nominal embedment depth			$h_{nom} = 35 \text{ mm}$		$h_{nom} = 35 \text{ mm}$	$h_{nom} = 55 \text{ mm}$
steel failure for tension- and shear load						
characteristic load	$N_{Rk,s}$	[kN]	8,7	14,0		
	$V_{Rk,s}$	[kN]	4,4	7,0		
	$k_2^{1)}$	[-]	0,8	0,8		
	$M^0_{Rk,s}$	[Nm]	5,3	10,9		
pull-out failure						
characteristic tension load in cracked and uncracked concrete C20/25	$N_{Rk,p}$	[kN]	1,5	1,5	7,5	
increasing factor concrete for $N_{Rk,p}$	ψ_C	C30/37	1,22			
		C40/50	1,41			
		C50/60	1,55			
concrete cone and splitting failure						
effective anchorage depth	h_{ef}	[mm]	27	27	44	
factor for	cracked	$k_{cr}^{1)}$	[-]	7,2		
	non cracked	$k_{ucr}^{1)}$	[-]	10,1		
concrete cone failure	spacing	$s_{cr,N}$	[mm]	$3 \times h_{ef}$		
	edge distance	$c_{cr,N}$	[mm]	$1,5 \times h_{ef}$		
splitting failure	spacing	$s_{cr,Sp}$	[mm]	120	120	160
	edge distance	$c_{cr,Sp}$	[mm]	60	60	80
installation safety factor	$\gamma_2^{2)} = \gamma_{inst}^{1)}$	[-]	1,2	1,2	1,0	
concrete pry out failure (pry-out)						
k-Factor	$k^{2)} = k_3^{1)}$	[-]	1,0			
concrete edge failure						
effective length of anchor	$l_f = h_{ef}$	[mm]	27	27	44	
outside diameter of anchor	d_{nom}	[-]	5	6		

¹⁾ Parameter relevant only for design according to CEN/TS 1992-4:2009

²⁾ Parameter relevant only for design according to ETAG 001, Annex C

TOGE concrete screw TSM high performance

Performances

Characteristic values for design method A

Annex C 1

**Table C2: Characteristic values of resistance in precast prestressed hollow core slabs
C30/37 to C50/60**

Anchorsize			TSM 6		
bottom flange thickness	d_b	[mm]	≥ 25	≥ 30	≥ 35
characteristic resistance	F_{Rk}^0	[kN]	1	2	3
installation safety factor	$\gamma_2^{1)} = \gamma_{inst}^{2)}$	[-]	1,2		

¹⁾ Parameter relevant only for design according to ETAG 001, Annex C

²⁾ Parameter relevant only for design according to CEN/TS 1992-4:2009

TOGE concrete screw TSM high performance

Performances

Characteristic values for anchorages in precast prestressed hollow core slabs

Annex C 2

Table C3: Characteristic values of resistance to fire exposure ¹⁾

Anchor size		TSM 6			
		TSM high performance		TSM high performance A4/HCR	
Nominal embedment depth		$h_{nom,1} = 35 \text{ mm}$	$h_{nom,2} = 55 \text{ mm}$	$h_{nom,2} = 35 \text{ mm}$	$h_{nom,2} = 55 \text{ mm}$
Steel failure for Tension- and shear load ($F_{Rk,s,fi} = N_{Rk,s,fi} = V_{Rk,s,fi}$)					
Fire resistance class					
R30	Characteristic resistance	$F_{Rk,s,fi30}$	[kN]	0,9	1,2
R60		$F_{Rk,s,fi60}$	[kN]	0,8	1,2
R90		$F_{Rk,s,fi90}$	[kN]	0,6	1,2
R120		$F_{Rk,s,fi120}$	[kN]	0,4	0,8
R30	Characteristic resistance	$M_{Rk,s,fi30}^0$	[Nm]	0,7	0,9
R60		$M_{Rk,s,fi60}^0$	[Nm]	0,6	0,9
R90		$M_{Rk,s,fi90}^0$	[Nm]	0,5	0,9
R120		$M_{Rk,s,fi120}^0$	[Nm]	0,3	0,6
Edge distance					
R30 bis R120		$c_{cr, fi}$	[mm]	$2 \times h_{ef}$	
Spacing					
R30 bis R120		$s_{cr, fi}$	[mm]	$4 \times h_{ef}$	

The characteristic resistance for pull-out failure, concrete cone failure, concrete pry-out failure and concrete edge failure shall be calculated according to TR 020 or CEN/TS 1992-4.

¹⁾ Not for using in prestressed hollow core slabs

TOGE concrete screw TSM high performance

Performances

Characteristic values under fire exposure

Annex C 3