



SIGNALLING DEVICES

GROTHE
URMET | GROUP



2020

Dear customers and friends,

We have on thing in our minds when we put together a new catalogue - you! Your help is essential to ensure that we give you the information needed on the quality that you have come to expect for a price which is appreciated.

The feedback from our friends and customers is highly valued as it is with your help that we can ensure that our catalogue contains the information you need. If the information you are seeking is not available, please do not hesitate to contact us. We will be glad to be of assistance.

In this edition you will find an extensive innovation especially in the range of our movement detectors but also in the range of chimes.

Enjoy the catalogue and we look forward to hearing from you soon.

The Grothe Export Team

Alexandra De Backer

Advisor Export

Phone: +49 (0)2242 8890-42

Fax: +49 (0)2242 8890-35

Email: adebacker@grothe.de

Daniela Faust

Advisor Export

Phone: +49 (0)2242-8890-118

Fax: +49 (0)2242-8890-35

Email: dfaust@grothe.de

□ CONTENT	3
□ DOORBELLS / CHIMES	4
Wireless Doorbells / Accessories	6
Electronic Doorbells / Chimes	18
Electromechanical Chimes	29
□ SOUND DEVICES / BELLS / BUZZERS / HORNS	31
Acoustic signalling devices / Bells	33
Bells / buzzers - domestic use	37
Bells / buzzers - industrial use	39
Horns / Combi-Horns (with optical signalling)	40
□ OPTICAL AND ACOUSTIC SIGNALLING DEVICES	44
Warning posts as a modular system / System M	48
Warning posts as a modular system / System T	52
Warning posts as a modular system / System T-Mini	56
Small warning / flashing beacons / Mounting parts	58
Middle / large flashing / combi flashing / rotating mirror beacons	60
Accessories	65
□ MOTION SENSORS / LED LIGHTNING	66
McGuard Series	70
Floodlights	73
□ TRANSFORMERS / RAIL MOUNTED DEVICES	74
Standard bell transformers / Safety transformers	78
Safety transformers / Staircase light time switches	79
□ BELL BUTTONS / CONTACTS / STOREY PLATES	80
Contacts for extra low voltage PROTACT	84
Storey plates / Gate contact / Contacts shells / Buttons	87
	88
□ DOOR OPENERS	96
Door opener	98
□ SPARE PARTS DOORSTATIONS/ SPECIAL PANELS / MODEL LIST / DISTRIBUTION	100
Spare parts	100
Request for special panels	101
GTC	103
List of types	105
International Distribution	Cover

Doorbells – Wireless / Electronic / Electromechanical

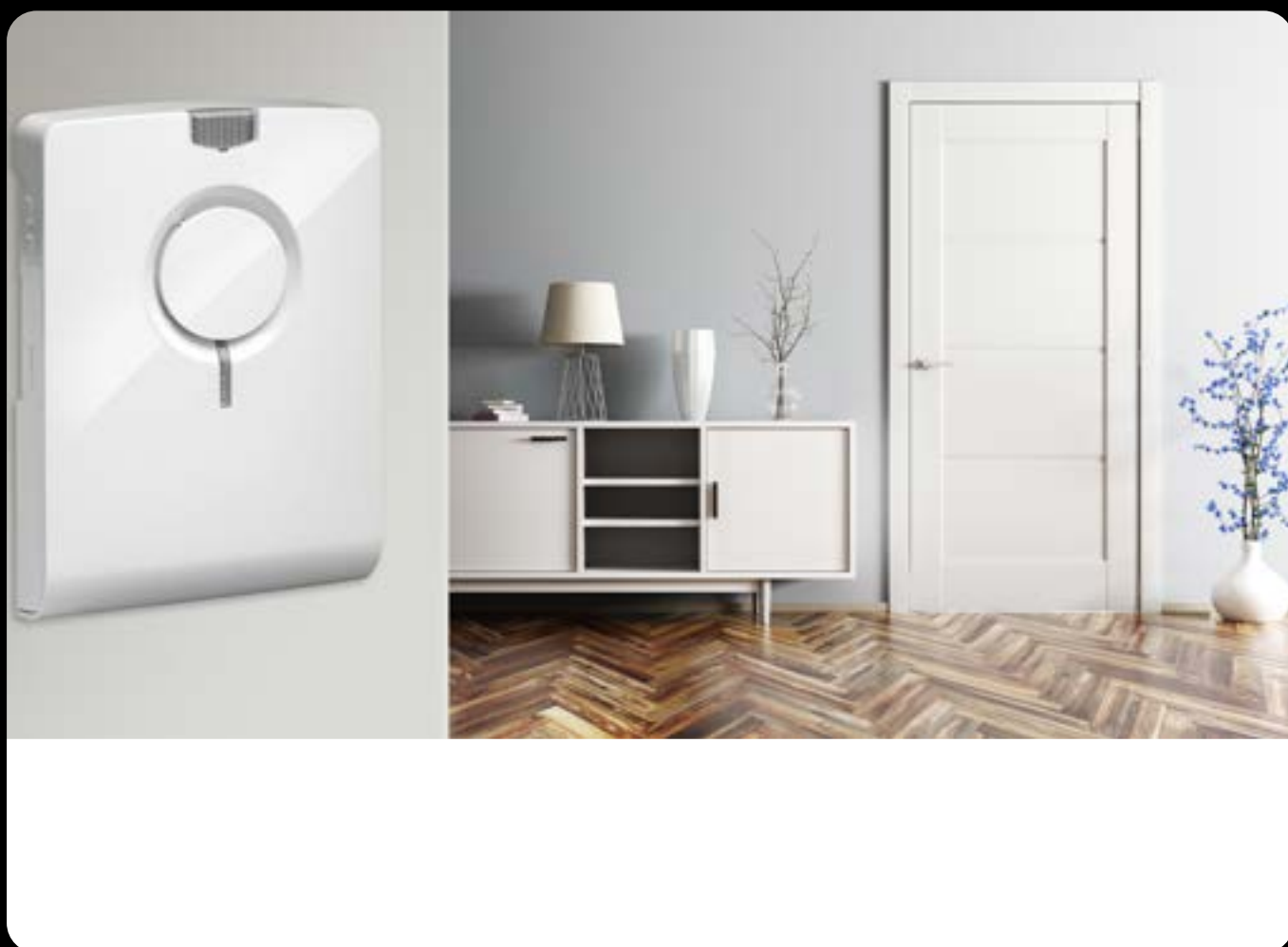

Doorbells – Wireless / Electronic / Electromechanical

The right doorbell to suit all tastes!

GROTHE doorbells sound good and look good. Choose your doorbell from a diverse product range – whether classically electromechanical, innovatively electronic or in combination with state-of-the-art wireless technology!

Wireless Doorbell Set – CALIMA 200



Our new Wireless Doorbell CALIMA 200

- Wireless
- Rapid operation
- 13 superb melodies / tunes
- Easy menu function
Voice display
- Multi-coloured LED Halo light
- Mute function with display
- Snooze mode
Pre-set time function

Our wireless doorbell means you can work either in the house or in the garden and still hear your visitors.

The CALIMA wireless doorbell is not only quick and easy to operate but it is also extremely flexible. Simply place the wireless doorbell in a desired place and due to the variable melody/tune programming, easy to see, colourful LED Halo light of CALIMA you will be notified reliably of every visitor.

CALIMA is a team player. Several wireless bell buttons and wireless doorbells are supplemented either via individual, central or matrix call and can be combined together without any transmission interference due to the individual codes available.

The settings on the CALIMA offer distinctions which are not only made on the melody but also the colour of the LED Halo light depending on which bell button is being used.

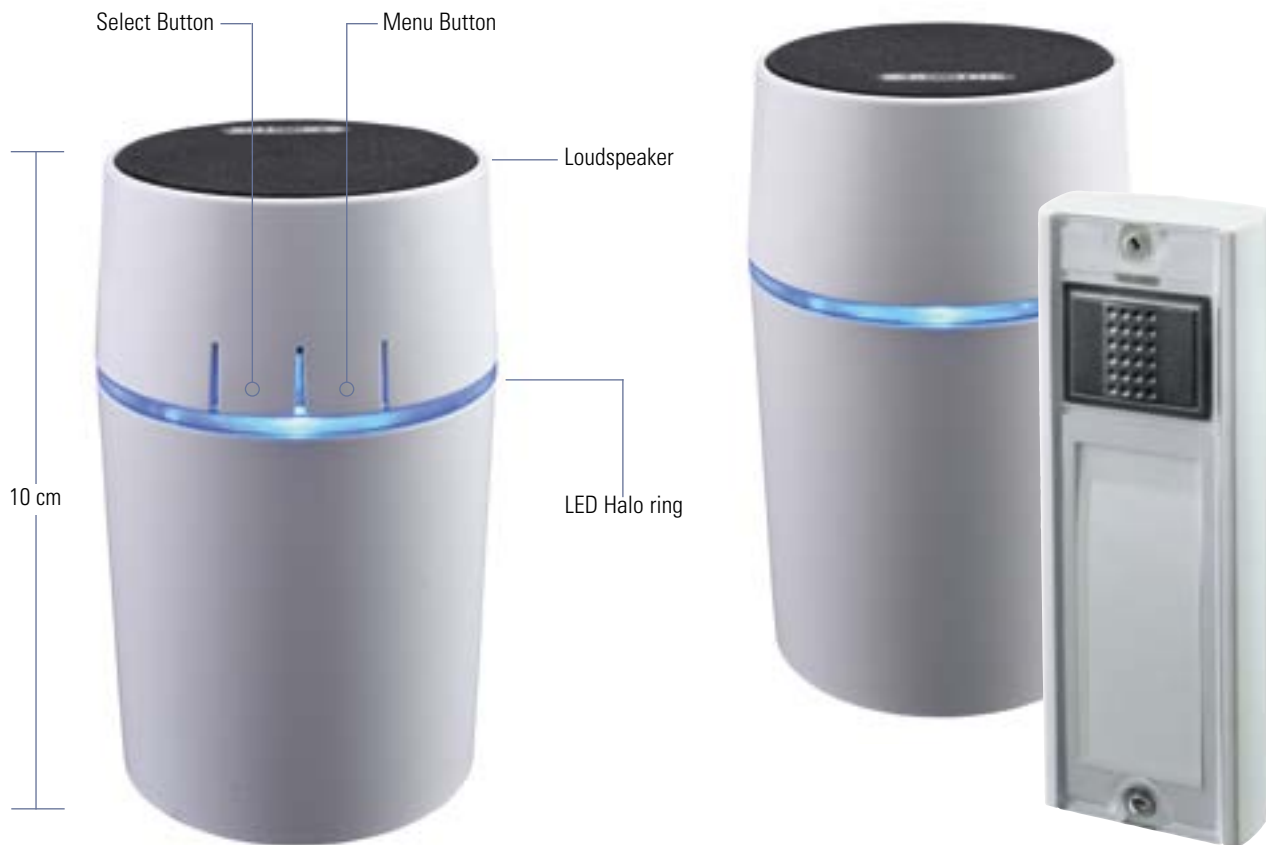

CALIMA 200 Set: Wireless doorbell and wireless bell button

Features / Operation / Functions

- Wireless doorbell and wireless bell button already coupled
- Dual touch (menu and select button)
- Menu navigation with voice output (languages depending on model) *
- Optical call signaling with LED Halo light blinking coloured (adjustable colour)
- 13 polyphone melodies
- Slumber function: mute for 1, 3 or 9 hours with optical indication as reminder
- Mute function with optical indication as reminder
- Large range 250 m: in combination with wireless bell button MISTRAL-SE03 range can be extended up to 500 m (optional / included in delivery, depending on model *, order no. 43441)
- Central call: One wireless bell button can be coupled with several wireless doorbells ECHO, MISTRAL CALIMA series
- Individual call: Up to 11 wireless bell buttons can be coupled with one wireless doorbell
- Matrix call: Several wireless bell buttons are coupled with several wireless doorbells
- Optical and acoustic Low Battery notification (wireless bell button MISTRAL SE03 only)
- Expandable system: additional wireless bell buttons and wireless doorbells can be coupled easily
- Colour of the LED Halo light and melody can be set individually for each wireless bell button
- Interference-free radio connection (each wireless bell button sends an individual code)
- Possibility to combine with existing door bells in combination with wireless bell button type MISTRAL SE03 (optional / included in delivery, depending on model) *
- Compatible to all wireless bell buttons type MISTRAL
- Optional alarm function (only in combination with wireless bell button type MISTRAL SE03, depending on model)

Technical Information

- Frequency: 868,35 MHz
 - Operating Range: 250 m
 - Dimensions
Receiver: Ø 60 x 102 mm
Sender: 36 x 100 x 17 mm
 - Wireless doorbell Calima 200**
 - Colour: White
 - Wall mount: No
 - Call differentiation: 11-fold
 - Volume: up to 83 dB(A) depending on melody
 - Dimensions: 60 (D) x 102 mm
 - Power supply: 4 batteries 1.5 V type AA (LR6)* (approx. 2 years battery life span)
 - Temperature range: 5 to 40 °C
 - Use: Indoors only
 - Wireless bell button**
 - Colour: white
 - Wall mounting: Yes
 - Frequency: 868.35 MHz
 - Maximum transmitting power: < 25 mW
 - Range 250 m / 500 m
 - Dimensions: 36 x 100 x 17 mm
 - Power supply: 2 batteries 1.5 V type AAA (LR03)* (approx. 7 years battery life span)
 - Protection degree: IP54
 - Use: Indoor / Outdoor
 - Temperature range: -15 to 50 °C
- *Batteries not included in delivery

Model	Order no.	Description / Features*	Model	Order no.	Description / Features*
CALIMA 200	43560	Wireless doorbell set • Voice output: German	CALIMA 200 NL	43563	Wireless doorbell set • Voice output: Dutch
CALIMA 200 GB	43561	Wireless doorbell set • Voice output: English	CALIMA 200 BE	43564	Wireless doorbell set • Voice output: Dutch / French

Wireless doorbells – ECHO Series



- Set individual ring tones
- MicroSD-Card slot
- Superb sound
- LED Flash
- Variable call combination
- Gloss finish
- Software included
- Pre-installed melodies / tunes

Add your favorite song as a Ring Tone! With the premium HiFi wireless doorbell ECHO, favorite melodies become ring tones via the use of a MicroSD-Card. Individual and flexible.

Variable call combinations allow a myriad of different ring tones to be set.

Enclosed in an elegant gloss casing with dual colour variation, the wireless doorbell ECHO not only adds visual style, but – whether used as a wall mount or in use as a stand alone appliance – makes it optimal for all entry areas and leaves room for change if required.

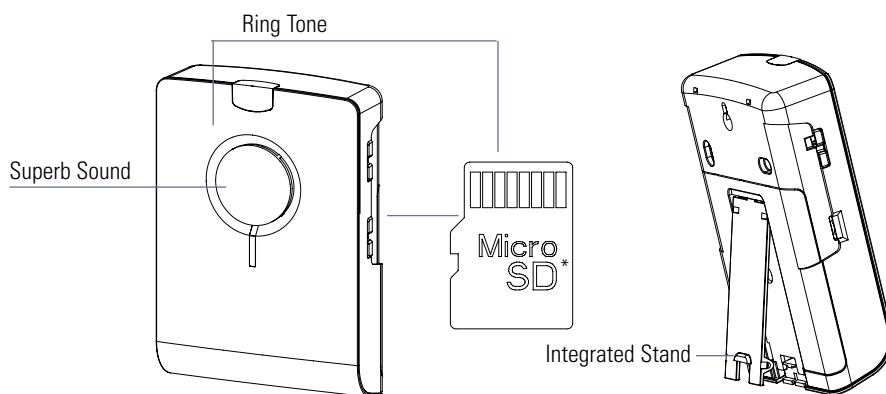

NOTE:
The HiFi wireless doorbell is also available as an electronic doorbell in 8–12 V AC/DC and 230 V AC.

HiFi Wireless Doorbell ECHO M / BM	
Features / Operation / Functions	Technical Information
<ul style="list-style-type: none"> • Gloss finish • Superb Sound • Bright LED-flash • Independent activation / deactivation of sound and light function • Central system: one wireless bell button is linked with several wireless doorbells • Individual system: several wireless bell buttons are linked with one wireless doorbell • Matrix call: several wireless bell buttons are linked with several wireless doorbells • Optic and acoustic Low Battery notification • Up to 20 wireless bell buttons can be coupled with one wireless doorbell • Individual wireless bell button ring tone • 20-fold call differentiation • Ring tone transmission via Micro-SD-Card* • Up to 90 seconds total playing time of ring tones • Incl. software for compilation of ring tones • Pre-installed melodies 	<ul style="list-style-type: none"> • Wireless doorbell ECHO: • Wall mounted: yes, or use integrated stand • Variable volume control max. 86 dB(A) • Dimensions: 180 x 120 x 50 mm • Power supply: batteries 4 x 1.5 V LR14 (AAA) (not incl.) or 8–12 V AC/DC with wall mount (order no. 43505) • Temperature range: 5 °C to 40 °C • Use: in dry rooms only • Wireless bell button MISTRAL SE03: • Colour: White • Power supply: 2 x 1.5 V LR03 (AA) (incl.) or 8–12 V DC • Frequency: 868.35 MHz • Range: 500 m open area • Degree of protection: IP54 • Dimensions: 36 x 100 x 17 mm • Temperature range: –15 to 50 °C

Model	Order no.	Description
ECHO M SW	43501	HiFi wireless doorbell Set <ul style="list-style-type: none"> • Colour: Black/ White • Incl. wireless bell button MISTRAL SE03
ECHO M WS	43502	HiFi wireless doorbell set <ul style="list-style-type: none"> • Colour: White • Incl. wireless bell button MISTRAL SE03
ECHO BM SW	43515	HiFi Wireless doorbell set <ul style="list-style-type: none"> • Colour: Black / White • Incl. motion sensor MISTRAL BM03
ECHO BM WS	43516	HiFi Wireless doorbell set <ul style="list-style-type: none"> • Colour White • Incl. motion sensor MISTRAL BM03
MH ECHO 120/M	43505	Wall Mount Echo M <ul style="list-style-type: none"> • Adapts to power supply socket and up to 2 conventional bell buttons on wireless doorbell ECHO M • Colour: White

* MicroSD-Card not included



Wireless doorbells – MISTRAL Series

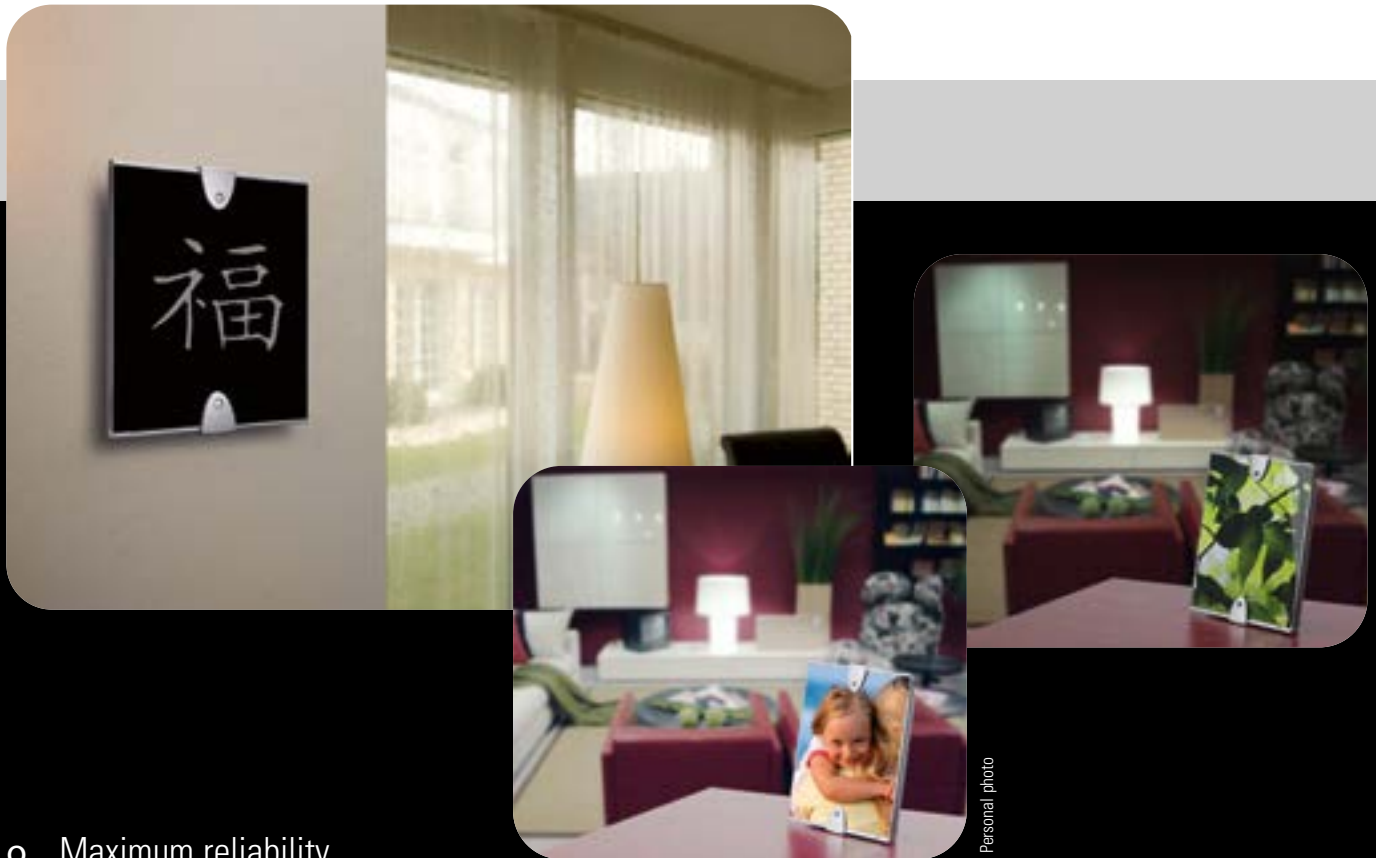

- Maximum reliability
- Signals to suit your style
- Motion sensor
- Flexible installation
- Pre-programmed wireless bell button and wireless doorbell
- 868.35 MHz transmission frequency

MISTRAL

Since its market launch, the wireless doorbell Mistral Series has won the heart of every electrician due to both its uncompromising quality and sophisticated technology.

It is not only cell freaks who are astounded by the new polyphone ring tones as the effective "System easyTIP" makes it easy to seek and find your favourite melodies quickly and easily.

The 5 to 10 year battery life span of the MISTRAL Series not only ensures years of reliable functions but also helps conserve the environment. MISTRAL wireless bell buttons and wireless doorbells announce punctually, optically and acoustically when a battery change is required.

SET MISTRAL 600



LED Flash

17 polyphone melodies/tunes

12 Designs

Frequency: 868.35 MHz
Operating range:
500 metres open area



LED Flash



Personalised Nameplate

Waterproof Combination wireless bell button
Degree of protection IP54

SET MISTRAL 650 SW



12 polyphone melodies/tunes



MISTRAL Accessories



MISTRAL RELAISBOX

A potential free contact in the MISTRAL series can be switched on via radio in the relaisbox. This potential free contact switches on charges up to 10 A and can be pre-timed which makes it ideal for exterior lighting, automatic doors or blinds.



MISTRAL MAGNETIC CONTACT

The window and door magnetic contact activates not only the MISTRAL wireless bell button but also electronic doorbells such as the CROMA 50, 100, 150 and 250 or ECHO 120. Ideal for alarm systems, eg: garden shed security.



MISTRAL WIRELESS REPEATER

The Mistral repeater increases the operating range of the MISTRAL wireless door bells series by 500 metres. Up to 20 MISTRAL wireless bell buttons can be tuned in to the repeater.



MISTRAL 800 MOBILE

Be reachable everywhere in the house with the mobile receiver MISTRAL 800. In addition to the acoustic and optic signal, a vibration effect is generated in loud environments.

MISTRAL 300M und 200M - New with a stylish and coloured acrylic front



White



Black



Silver



Red



Green



Silver/White



MISTRAL 650 SW Set



MISTRAL 650 WS Set



MISTRAL 350 SW Set



MISTRAL 350 WS Set



MISTRAL 350 SW



MISTRAL 350 WS

Functions

- Gloss finish
- 12 polyphone ring tones
- Bright LED flash
- Independent activation / deactivation of sound and light function
- Variable volume control max. 86 dB(A)
- Adjustable mute function / time limit setting
- Central call: multiple wireless doorbells coupled with one wireless bell button
- Individual call: several wireless doorbells coupled with one wireless bell button
- Matrix Call: Central and individual call combination
- Optic and acoustic Low battery display
- 12 wireless bell button combinations
- Individual wireless bell button ring tone
- 12-fold call differentiation

Technical Information:

- Power Supply
Wireless doorbell:
Batteries 4 x 1.5 V LR14/C (not included) or 8–12 V AC/DC
Wireless bell button:
Batteries 2 x 1.5 V LR03 / AA (included) or 8–12 V DC
- Frequency: 868.35 MHz
- Operating Range: 500 m open area
- Dimensions
Wireless doorbell: 180 x 120 x 50 mm
Wireless bell button: 36 x 100 x 17 mm

Sets

Model	Order no.	Description
MISTRAL 650 SW	43552	Wireless doorbell set <ul style="list-style-type: none"> • Colour: Black / White • 12-fold Call differentiation, 14-fold with a cable connection • Incl. wireless bell button MISTRAL SE03
MISTRAL 650 WS	43553	Wireless doorbell set <ul style="list-style-type: none"> • Colour: White • 12-fold Call differentiation, 14-fold with a cable connection • Incl. wireless bell button MISTRAL SE03
MISTRAL 350 SW	43550	Wireless doorbell set <ul style="list-style-type: none"> • Colour: Black/ White • 12-fold Call Differentiation • Incl. wireless bell button MISTRAL SE03
MISTRAL 350 WS	43551	Wireless doorbell set <ul style="list-style-type: none"> • Colour: White • 12-fold Call differentiation • Incl. wireless bell button MISTRAL SE03
MISTRAL 350E SW	43558	Wireless doorbell <ul style="list-style-type: none"> • Colour: Black / White • 12-fold Call differentiation
MISTRAL 350E WS	43559	Wireless doorbell <ul style="list-style-type: none"> • Colour: White • 12-fold Call differentiation

Wireless doorbells MISTRAL 600 – Product overview / MISTRAL 200M / 300M



Functions:

- 17 polyphone Ring Tones
- Independent activation/deactivation of sound and light function
- Variable volume control max. 86 dB(A)
- Alarm Setting: Emergency Tone
- Central call: one wireless bell button is linked with several wireless doorbells
- Individual call: several wireless bell buttons are linked with one wireless doorbell
- Matrix call: several wireless bell buttons are linked to several wireless doorbells
- Optic and acoustic LowBatt- Display
- 20 wireless bell button combination
- Individual call tone for wireless bell buttons
- 17-fold call differentiation

Technical Information:

- Power supply
- Wireless doorbell: Batteries 4 x 1.5 V LR14/C (not included) or 8–12 V AC/DC, Wireless bell button MISTRAL SE03 Batteries 2 x 15 V LR03 / AA (included) or 8–12 V DC
- Motion Sensor MISTRAL BM03: Lithium battery CR123A (included) or 8–12 V DC/AC
- Frequency: 868.35 MHz
- Operating range: 500 m open area
- Dimensions
- Wireless doorbell: 180 x 140 x 50 mm
- Wireless bell button MISTRAL SE03: 36 x 100 x 17 mm
- Motion sensor BM03: 69 x 124 x 54 mm

Model	Order no.	Description
MISTRAL 600	43400	Deluxe wireless doorbell Set • 12 design selections • LED-Flash • Incl. wireless bell button MISTRAL SE03
MISTRAL 600ws	43410	Deluxe wireless doorbell Set • 12 design selections • Casing/ White • LED-Flash • Incl. wireless bell button MISTRAL SE03
MISTRAL 300M	43300	Wireless doorbell Set • Colour: White • LED Flash • Incl. wireless bell button MISTRAL SE03
MISTRAL 300M ws	43142	Wireless doorbell Set • Acrylic cover: Colour: White • LED Flash • Incl. wireless bell button MISTRAL SE03
MISTRAL 300M sw	43143	Wireless doorbell Set • Acrylic cover: Black • LED Flash • Incl. Wireless bell button MISTRAL SE03
MISTRAL 300M si	43144	Wireless doorbell set • Acrylic cover: Silver • LED Flash • Incl. Wireless bell button MISTRAL SE03
MISTRAL 300M rt	43145	Wireless doorbell Set • Acrylic cover: Red • LED Flash • Incl. Wireless bell button MISTRAL SE03
MISTRAL 300M gn	43146	Wireless doorbell Set • Acrylic cover: Green • LED Flash • Incl. Wireless bell button MISTRAL SE03
MISTRAL 300M ws/si	43372	Wireless doorbell Set • Acrylic cover: White/Silver • LED Flash • Incl. Wireless bell button MISTRAL SE03
MISTRAL 300M BM	43315	Wireless doorbell Set • Door colour: White/Silver • LED Flash • Incl: Wireless motions sensor MISTRAL BM03
MISTRAL 200M	43305	Wireless doorbell Set • Door colour: White/Silver • Incl: Wireless bell button MISTRAL SE03 • External power supply unavailable
MISTRAL 200M ws	43182	Wireless doorbell Set • Acrylic colour: White • Incl: Wireless bell button MISTRAL SE03 • External power supply unavailable
MISTRAL 200M sw	43183	Wireless doorbell Set • Acrylic door cover: Black • Incl: Wireless bell button MISTRAL SE03 • External power supply unavailable
MISTRAL 200M si	43184	Wireless doorbell Set • Acrylic door colour: Silver • Incl: Wireless bell button MISTRAL SE03 • External power supply unavailable
MISTRAL 200M rt	43185	Wireless doorbell Set • Acrylic door: Red • Incl: Wireless bell button MISTRAL SE03 • External power supply unavailable
MISTRAL 200M gn	43186	Wireless doorbell Set • Acrylic door colour: Green • Incl: Wireless bell button MISTRAL SE03 • External power supply unavailable
MISTRAL 200M ws-si	43371	Wireless doorbell Set • Acrylic door colour: White/Silver • Incl: Wireless bell button MISTRAL SE03 • External power supply unavailable

Please note: walls, doors, metal components etc. may considerably reduce operating range

Wireless doorbell MISTRAL 210 M / 300M E / 400M / 600E / SE03 / BM03

Set

Model	Order no.	Description
MISTRAL 210M	43303	Wireless doorbell Set <ul style="list-style-type: none"> Cover colour: Grey External power supply unavailable Incl. wireless door bell MISTRAL SE03

Wireless doorbells

Model	Order no.	Description
MISTRAL 600E	43401	Deluxe Wireless doorbell <ul style="list-style-type: none"> 12 interchangeable designs Casing: Silver LED-Flash
MISTRAL 600E ws	43411	Deluxe Wireless doorbell <ul style="list-style-type: none"> 12 interchangeable designs Casing: White LED-Flash
MISTRAL 300M E	43301	Wireless doorbell <ul style="list-style-type: none"> Colour White/Silver LED-Flash

Plug-in wireless doorbells (Set / Single)

Functions:

- 17 polyphone Ring Tones
- Slide switch for function mode selection (Flash / Melody / Melody + Flash / Mute)
- Variable volume control max. 80 dB(A)
- Alarm setting: Emergency tone
- LED-Flash
- Central call: one wireless bell button is linked with several wireless doorbells
- Individual call: several wireless bell buttons are linked with one wireless doorbell
- Matrix call: several wireless bell buttons are linked to several wireless doorbells
- 20 wireless bell button combination

- Individual call tone for senders
- 17-fold call differentiation
- Call forwarding on wireless bell button MISTRAL SE03

Technical Information:

- Power Supply
- Wireless doorbell: 230 V AC / 50 Hz,
- Wireless bell button MISTRAL SE03:
- Batteries 2 x 1,5 V LR03 / AA (incl.) or 8–12 V DC
- Frequency: 868.35 MHz
- Operating range: 500 m open area
- Dimensions
- Wireless doorbell: 127 x 62 x 78 mm
- Wireless bell button SE03: 36 x 100 x 17 mm

Model	Order no.	Description
MISTRAL 400M	43310	Plug-in wireless doorbell Set <ul style="list-style-type: none"> 230 V Euro socket LED-Flash Incl. wireless bell button MISTRAL SE03
MISTRAL 400M E	43311	Plug-in wireless doorbell <ul style="list-style-type: none"> 230 V Euro socket LED-Flash
MISTRAL 400M UK	43314	Plug-in wireless doorbell Set <ul style="list-style-type: none"> 230 V UK socket LED-Flash Incl. wireless bell button MISTRAL SE03
MISTRAL 400M UK S	43318	Plug-in wireless doorbell <ul style="list-style-type: none"> 230 V UK socket LED-Flash

Wireless bell buttons / motion sensor

Model	Order no.	Description
MISTRAL SE03-s	43440	Wireless bell button <ul style="list-style-type: none"> Colour: Silver/Anthracite finish All MISTRAL, ECHO M, CALIMA Chimes 868.35 MHz 500 m Operating range-open area Call forwarding Degree of protection IP54 LED Function control Incl. Batteries 2 x 1,5 V (Typ LR03/AAA Alkaline) Long life -15 to +50 °C External power 8–12 V DC
MISTRAL SE03	43441	Wireless bell button <ul style="list-style-type: none"> Colour: White All MISTRAL, ECHO M, CALIMA Doorbells 868.35 MHz 500 m Operating range open area Call forwarding Degree of protection IP54 LED Function control Incl. Batteries 2 x 1,5 V (Typ LR03/AAA Alkaline) Long life -15 to +50 °C External power 8–12 V DC
MISTRAL BM03	43445	Wireless motion sensor <ul style="list-style-type: none"> Colour: White All MISTRAL, ECHO M, CALIMA Doorbells 868.35 MHz 500 m Operating range-open area Max. monitoring range 108°/15 m operating range Motion tested LED Display Adjustable delay time 3–60 s Incl. Lithium battery 3 V (Type CR123A) External power 8–12 V AC/DC Degree of protection IP20 -15 to +50 °C Dimensions 69 x 124 x 54 mm Mounting hinge

Please note: Walls, Doors, Metal components etc. may considerably reduce operating range



MISTRAL 600E interchangeable design



MISTRAL 300M E



MISTRAL 400M



MISTRAL SE 03-s



MISTRAL SE 03



MISTRAL BM 03

POLO 100 / MISTRAL RB, MK, WR, 800 Mobile / NA / AL



Accessories

Model	Order no.	Description
MISTRAL RB	43385	<p>MISTRAL Relaisbox</p> <ul style="list-style-type: none"> • Suitable for MISTRAL Series • Electric consumer switch • Switch contact: 203 V, 10 A • Timer 1–1000 s • 16 wireless bell button combination • Power supply 8–12 V AC/DC or 3 V Lithium Battery CR123A (not included) <ul style="list-style-type: none"> • Frequency 868 MHz • Operating range open area 500 m • Operating temperature –5 to +40 °C • Degree of protection IP66 • Dimensions: 110 x 110 x 70 mm • Colour: Grey
MISTRAL RB Set	43386	<p>MISTRAL Relaisbox Set</p> <ul style="list-style-type: none"> • All features of 43385 as Set with wireless bell button MISTRAL SE03
MISTRAL MK	43394	<p>MISTRAL Magnetic contact</p> <ul style="list-style-type: none"> • Activates MISTRAL wireless bell button or electronic doorbells • Compatible with: MISTRAL wireless bell button SE03 ECHO, CROMA 50 CROMA 100 und 150 und 250 FM-Doorbell 120 (DC power supply) <ul style="list-style-type: none"> • 2 m connection cable • Dimensions: 60 x 17 x 11 mm • Colour: White
MISTRAL WR	43480	<p>MISTRAL Repeater</p> <ul style="list-style-type: none"> • Suitable for MISTRAL Series • 500m operating range increase on MISTRAL wireless bell buttons • 20 wireless bell button combination • Power supply 8 – 12 V AC/DC Batteries (2 x 1,5 V LR6/AA) not included <ul style="list-style-type: none"> • Frequency: 868.35 MHz • Operating range: 500 m open area • Protection: IP20 • Dimensions: 83 x 85 x 30 mm • Colour: White
MISTRAL 800 Mobile SW	43380	<p>MISTRAL Mobile</p> <ul style="list-style-type: none"> • MISTRAL Wireless doorbell • Suitable for MISTRAL Series • Portable/Belt clip • Optic/acoustic signal Vibration • 4 Call tones • 4-fold Call differentiation • Battery life span ECO mode approx. 5 years Normal usage approx. 2 years <ul style="list-style-type: none"> • Frequency: 868.35 MHz • Operating range: 500 m open area • Degree of protection: IP20 • Dimensions 80 x 60 x 30 mm • Colour: Black/White • Missed call display • 15 wireless bell button combination • Power supply 9 V Block battery (not included)
MISTRAL 800 Mobile SW Set	43382	<p>MISTRAL Mobile Set</p> <ul style="list-style-type: none"> • All features of 43380 as Set with MISTRAL SE03 wireless bell button 43441
MISTRAL 800 Mobile WS	43381	<p>MISTRAL Mobile</p> <ul style="list-style-type: none"> • Features of 43380/White casing
NA 9V-GPE	43399	<p>Net Adapter</p> <ul style="list-style-type: none"> • Suitable for MISTRAL 600, 300 and wireless bell button/ Relay box, repeater • Incl. suitable plug/socket • Wireless bell button/Relay box and repeater usage: separate plug and plug directly to terminal • Power supply 9 V DC, maximum 0,5 A (4,5 W) • Cable approx. 1,75 m
AL 1057/614	39013	<p>Lithium battery 3 V CR123 A</p> <ul style="list-style-type: none"> • Suitable for motion sensor MISTRAL BM und Relaisbox

Wireless doorbells POLO 100

Model	Order no.	Description
POLO 100 W/W	43251	Wireless doorbell set (white) <ul style="list-style-type: none"> • LED indication • 16 melodies • 80 db (A), adjustable • Mute function • Batteries wireless bell button AAA LR03 1.5 V (not incl.) • 250 m range (free field) • Frequency 868.35 MHz • Batteries wireless doorbell AA 1,5 V (not incl.) • Incompatible with Mistral
POLO 100 W/S	43252	Wireless doorbell set (black) <ul style="list-style-type: none"> • like 43251 but black colour • Incompatible with Mistral



Please note: Walls, doors, metal components etc. may considerably reduce operating range
 To increase the range in difficult conditions, use MISTRAL WR (order No. 43480);

Wireless doorbells MISTRAL– Circuit overview

The figures show some of the possible combinations. Among other things, each wireless doorbell can be activated individually or centrally.

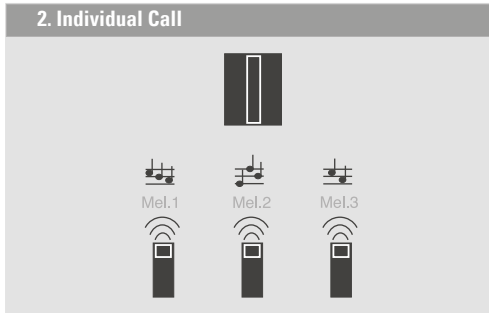
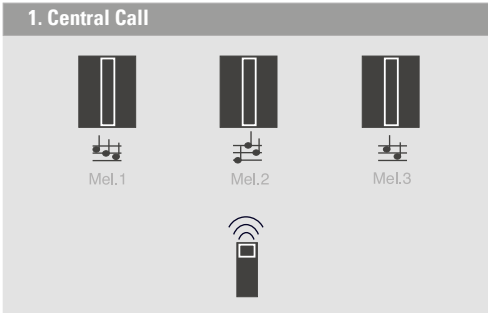

Central call

One wireless bell button can activate any number of wireless chimes:
One wireless bell button is coupled with several wireless chimes in different rooms.

Individual call

Up to 11 wireless bell buttons can activate 1 wireless chime:
Several wireless bell buttons at different doors/gates are coupled with one wireless chime in one room.

Matrix call

Several wireless chimes can be activated individually.
Several wireless bell buttons at different doors/gates are coupled with several wireless chimes in different rooms – including with multiple coupling.

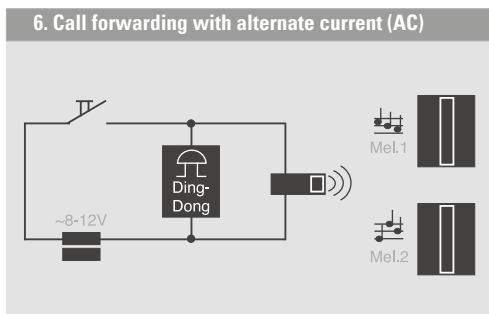
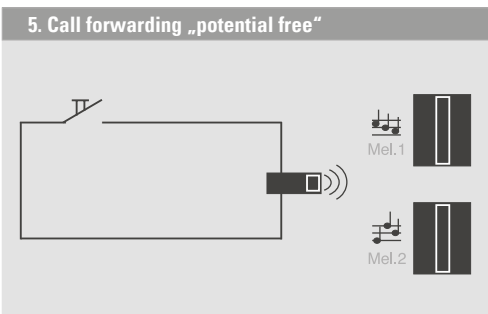
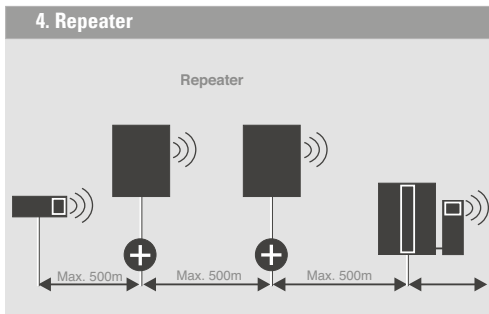
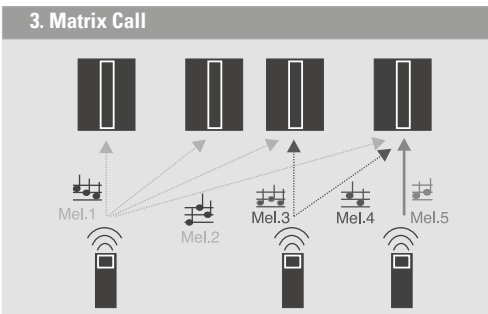

Note: Walls, doors, metal parts, etc. can reduce the range significantly.

Overview: Reduction of range by different materials

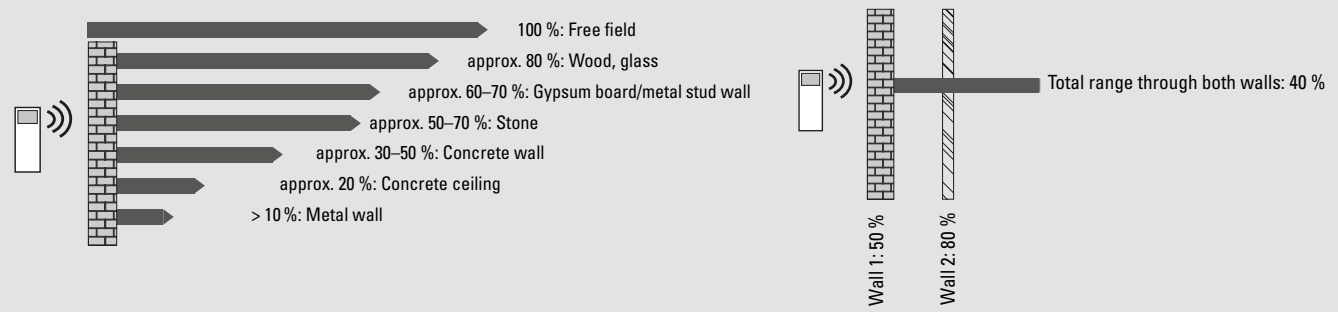

Electronic doorbells – CROMA Series / ECHO 120 / 230



CROMA

- o User-friendly *easyTIP* control unit
- o Optimal pre-assembly
- o Multi-volt operation
- o MUTE function

Electronic doorbells in the CROMA Series offer a large choice of melodies/tunes to announce guests. The integrated *easy-TIP*-unit behind the design element allows for simple changes to the Ring Tone, Alarm Function and the Silent function (Mute button).

The 230 Volt-Doorbell with its integrated Transformer is ideal for mixed installation and renovations. For instance, by using the existing 230 V-supply in the corridor.

CROMA 100A

CROMA 150 and CROMA 250



Batteries 4x 1.5 V LR 14
or 8-12 V AC/DC

12 polyphone
melodies/tunes



LED Flash

Snooze function

17 polyphone
melodies/tunes

CROMA 230



CROMA 50



3 melodies/tunes

Doorbell with battery mode
and standard function



Volume Control

easyTIP



Multi-Volt-Operation 8/12 V
AC/DC or 230 V AC
Integrated Transformer
VDE-approved 

CROMA 50 - New with a stylish and coloured acrylic front



White



Black



Silver



Red



Green

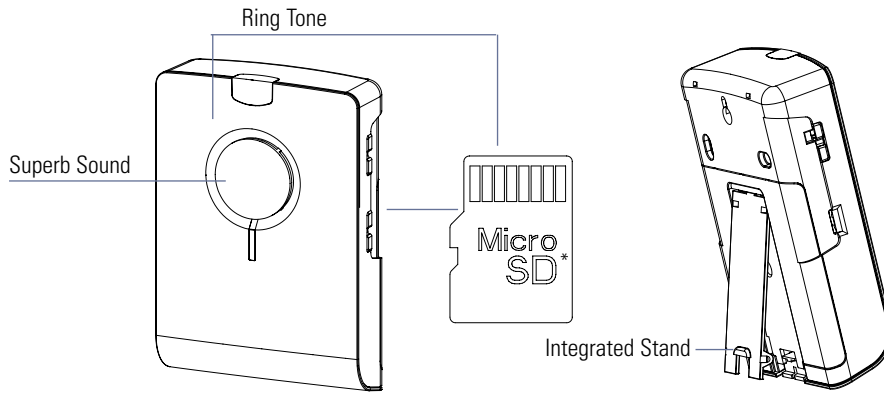

Electronic doorbells ECHO 120 / 230

Feature / Operations / Functions

- Gloss Finish
- Superb Sound
- Bright LED-Flash
- Independent activation/deactivation sound and light function
- Variable volume control max. 86 dB(A)
- Optic and acoustic LowBatt- Display
- 2 Button connection
- Individual ring tone for wireless bell buttons
- 2-fold Call differentiation
- Call tone transmission by Micro-SD-Card*
- Up to 90 seconds total playing time of Ring Tones
- Incl. Software for compilation of Ring Tones
- Pre-installed Melodies

Technical information

- Dimensions: 180 x 120 x 50 mm

Model	Order no.	Description
ECHO 120 SW	43530	HiFi-Doorbell <ul style="list-style-type: none"> • Colour: Black / White • Power supply Batteries 4 x 1,5 V LR14/C (not included) or 8 - 12 V AC/DC
ECHO 120 WS	43531	HiFi-Doorbell <ul style="list-style-type: none"> • Colour: White • Power supply Batteries 4 x 1,5 V LR14/C (not included) or 8 - 12 V AC/DC
ECHO 230 SW	43540	HiFi-Doorbell <ul style="list-style-type: none"> • Colour: Black / White • Power supply 230 V / 50 Hz (VDE Power supply board) or 8 - 12 V AC/DC
ECHO 230 WS	43541	HiFi-Doorbell <ul style="list-style-type: none"> • Colour: White • Power supply 230 V / 50 Hz (VDE power supply board) or 8 - 12 V AC/DC

*MicroSD-Card not included.



Electronic doorbells CROMA 150 / 250



CROMA 150 SW



CROMA 150 WS



CROMA 250 SW



CROMA 250 WS

Feature / Operations / Functions

- Gloss finish
- 12 polyphone Ring tones
- Bright LED-Flash
- Independent activation/deactivation sound and light function
- Variable Volume Control max. 86 dB(A)
- Adjustable Mute function/time limit setting
- 2 Button connection
- Individual Ring Tone for Buttons
- 2-fold Call Differentiation
- Dimensions: 180 x 120 x 50 mm

Model	Order no.	Description
CROMA 150 SW	43554	Wireless doorbell Set • Colour: Black / White • Power supply: Batteries 4 x 1,5 V LR14/C or 8 – 10 V AC/DC
CROMA 150 WS	43555	Wireless doorbell Set • Colour: White • Power supply: Batteries 4 x 1,5 V Model LR14/C or 8 – 10 V AC/DC
CROMA 250 SW	43556	Wireless doorbell Set • Colour: Black / White • Power supply: 230 V / 50 Hz or 8 – 10 V AC/DC
CROMA 250 WS	43557	Wireless doorbell Set • Colour: White Power supply: 230 V / 50 Hz or 8 – 10 V AC/DC

CROMA 100A



CROMA 100A



CROMA 100A ws/ws



CROMA 100A ws/si



CROMA 100A ws/sw

The designer chime with a large selection of melodies and additional ALARM function – a „jewel“ in any room!

Functions

- 17 brilliant polyphone sounds (2/3 tone, Westminster, pop, special tone seq. for people with hearing difficulties, classical etc.)
- Switchable from melody to ALARM tone (optimal for use in combination with motion sensors in a shop, for example, when a melody should sound during the day and an ALARM tone at night)
- Volume adjustable up to max. 86 dB(A)
- 2 different paging signals for optimum access control
- SILENCE function (one-button mute function) with LED indicator
- User-friendly *easyTIP* control unit for all functions (fold-up cover)

Installation

- Operated with 4 x 1.5 V batteries (model LR14/C, alkaline baby cell, not incl. in delivery) or 8–12 V AC/DC (250 mA)
- Safe ring tone activation with potential-free contact or with 8–12 V AC/DC
- Can also be used for mixed installations and renovation (e.g.

existing 8 V power supply from a customer-supplied bell transformer and triggering with a potential-free contact)

- Optimum pre-assembly (screw distances correspond to flush-mounting box diameter)
- Parallel circuit to further CROMA chimes or to electromechanical chimes possible

Technical data

- Voltages/Currents: see above (minimal standby losses for long battery life — in normal use approx. 3 years incl. LowBatt display)
- Max. 86 dB(A)
- 191 x 163 x 51 mm
- Temperature range +5 °C to +40 °C
- VDE-tested 
- Frosted semi-transparent 4 mm perspex pane; high-grade silver or grey-painted ABS plastic
- IP range IP40

Model	Order no.	Description
CROMA 100A	43170	Electronic doorbell • Silver/Grey
CROMA 100A ws/ws	43172	Electronic doorbell • White/White
CROMA 100A ws/si	43173	Electronic doorbell • White/Silver
CROMA 100A ws/sw	43174	Electronic doorbell • White/Black
NA 9V-GPE	43399	Mains adapter • Black • Disconnect angled plug and put 9 V directly to input terminal <i>(without illustration)</i> • 9 V DC • Max. 0.5 A (4.5 W) • With 1.75 m lead

CROMA 230 / 231A



CROMA 230A



CROMA 230A-a/w



CROMA 231A



CROMA 231A ws/ws



CROMA 231A ws/si



CROMA 231A ws/sw

Deluxe electronic doorbell with a large selection of melodies and additional ALARM function — multi-volt operation up to 230 V makes it particularly attractive

Functions

- 17 brilliant polyphone sounds (2/3 tone, Westminster, pop, special tone sequence for people with hearing difficulties, classical etc.)
- Switchable from melody to ALARM tone (optimal for use in combination with movement detectors in a shop, for example, when a melody should sound during the day and an ALARM tone at night)
- Volume adjustable up to max. 86 dB(A)
- 2 different paging signals for optimum access control
- SILENCE function (one-button mute function) with LED indicator
- User-friendly *easyTIP* control unit for all functions (fold-up cover)

Installations

- Multi-volt operation with 8–12 V AC/DC (250 mA) or 230 V AC (15 mA)
- Safe ring tone activation with potential-free contact or with 8–12 V AC/DC or 230 V AC (opto-coupler input for max. safety)
- Thanks to integrated transformer, can also be used for mixed installations and renovation (e.g. 230 V power supply and triggering over 8 V of an existing bell transformer)
- Optimum pre-assembly (screw distances correspond to flush-mounting box diameter)
- Parallel circuit to further CROMA chimes or to electromechanical chimes possible

nical chimes possible

Technical data

- Voltages/Currents: see above (ecologically sound operation due to minimal standby losses)
- Max. 86 dB(A)
- Dimension 150 x 115 x 45 mm
- Temperature range +5°C to +40°C
- VDE-tested
- High-grade, stable ABS plastic; white with silver-painted design
- Degree of protection IP40

Note

- If supplied with 230 V AC power, in accordance with the standard, an all-pole mains control switch must be provided in the building electrical installation!
- The integrated transformer is not suitable for this and is not designed for the operation of electrical door openers. If necessary, an additional transformer (e.g. GT 3148) must be supplied by the customer.
- When triggering with 230 V, use only suitable 230V buttons!

Model	Order no.	Description
CROMA 230A	43175	Electronic doorbell • White/Silver • 150 x 115 x 45 mm
CROMA 230A-a/w	43190	Electronic doorbell • White/Silver • 150 x 115 x 45 mm
CROMA 231A	43177	Electronic doorbell • Silver/Grey • 191 x 163 x 51 mm
CROMA 231A ws/ws	43195	Electronic doorbell • White/White • 191 x 163 x 51 mm
CROMA 231A ws/si	43196	Electronic doorbell • White/Silver • 191 x 163 x 51 mm
CROMA 231A ws/sw	43197	Electronic doorbell • White/Black • 191 x 163 x 51 mm

Electronic doorbells CROMA 50 / 225A

Inexpensive battery-operated electronic chime with standard functions

Functions

- 3 sounds (2/3 tone, Westminster)
- Volume adjustable up to max. 83 dB(A)
- 3 different paging signals
- Continuous tone only in the case of continuous non-isolated impulse

Installation

- Operated with 4 x 1.5 V batteries (model LR14/C, alkaline baby cell, not incl. in delivery)

- Safe ring tone activation with potential-free contact or with 8–12 V AC/DC
- Optimum pre-assembly (screw distances correspond to flush-mounting box diameter)
- Parallel circuit to further CROMA chimes or to electromechanical chimes possible

Technical data

- Voltages/Currents: see above (minimal standby losses for long battery life - in normal use approx. 3 years)
- Max. 83 dB(A)
- Temperature range +5°C to +40°C

Model	Order no.	Description
CROMA 50	43150	Electronic doorbell • White ABS plastic with silver-grey design • 150 x 115 x 40 mm
CHIME 225A	43225	Electronic doorbell • Timeless design (ABS plastic cover) • 160 x 160 x 65 mm
CROMA 50 ws	43152	Electronic doorbell • like CROMA 50 • acrylic door color white
CROMA 50 sw	43153	Electronic doorbell • like CROMA 50 • acrylic door color black
CROMA 50 si	43154	Electronic doorbell • like CROMA 50 • acrylic door color silver
CROMA 50 rt	43155	Electronic doorbell • like CROMA 50 • acrylic door color red
CROMA 50 gn	43156	Electronic doorbell • like CROMA 50 • acrylic door color green



Electronic doorbells CROMA 100 – Circuit overview

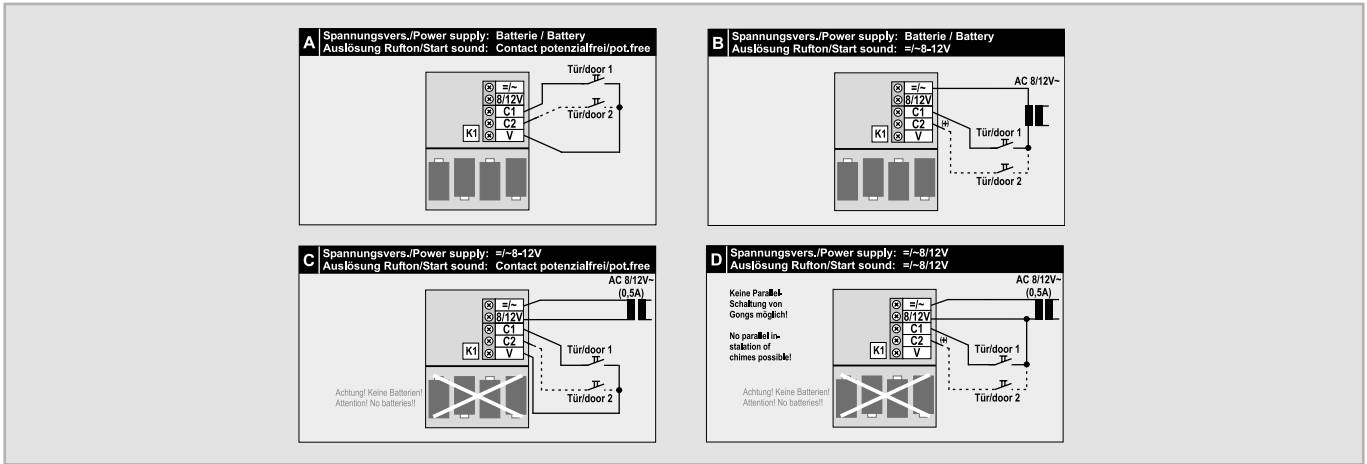

Electronic doorbell CROMA 230 – Circuit overview

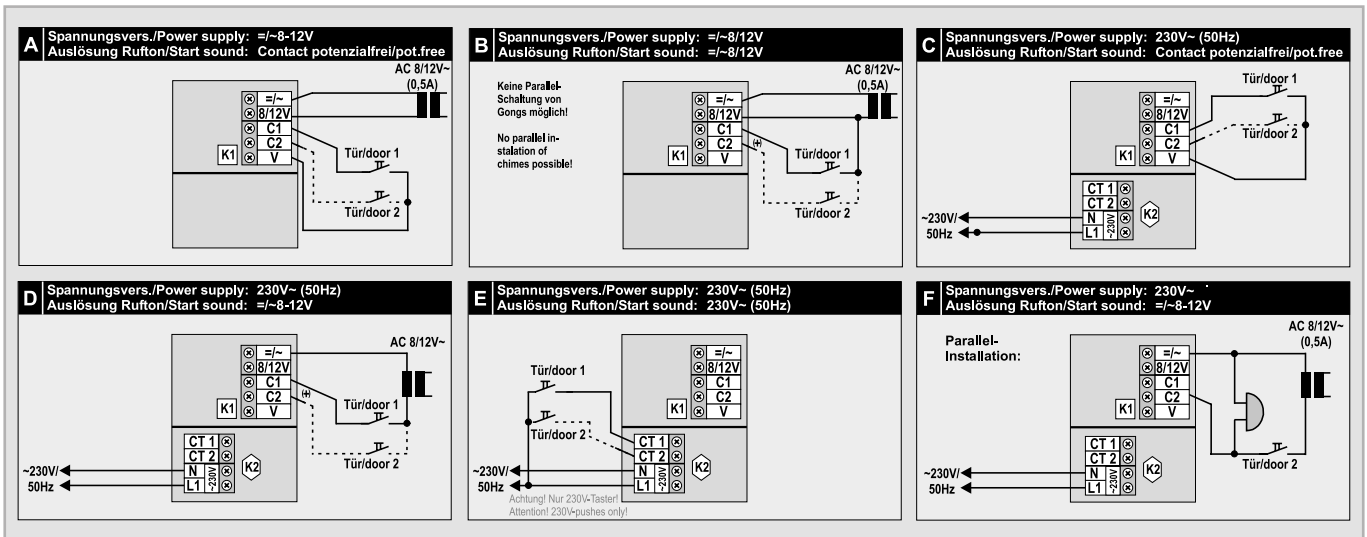

Electronic doorbells CROMA 50 / 225A – Circuit overview

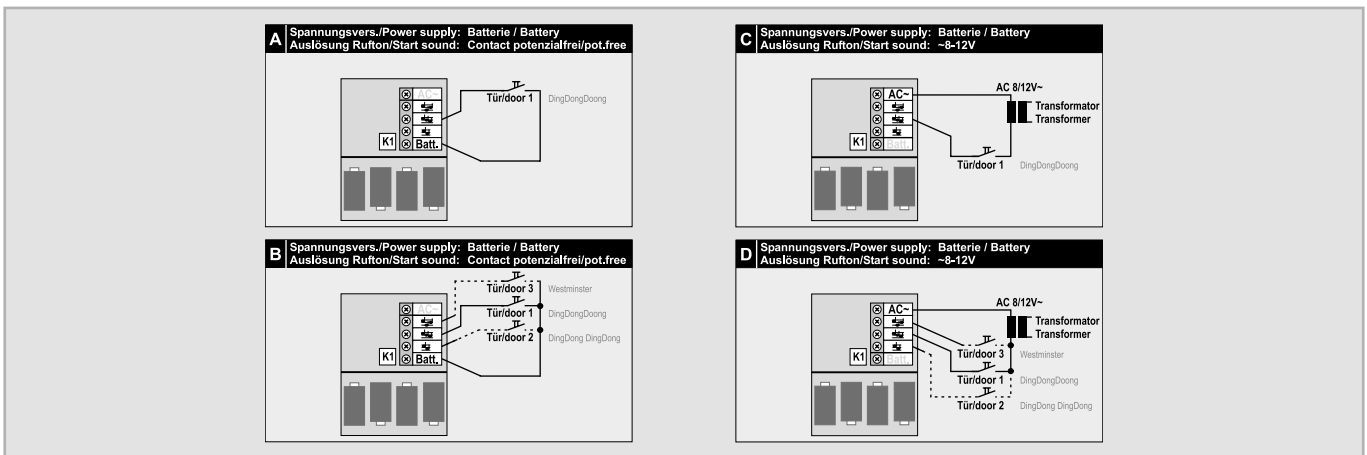

Electronic doorbell ECHO – Circuit overview

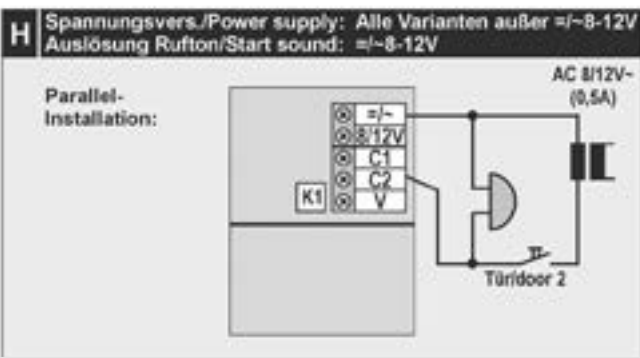
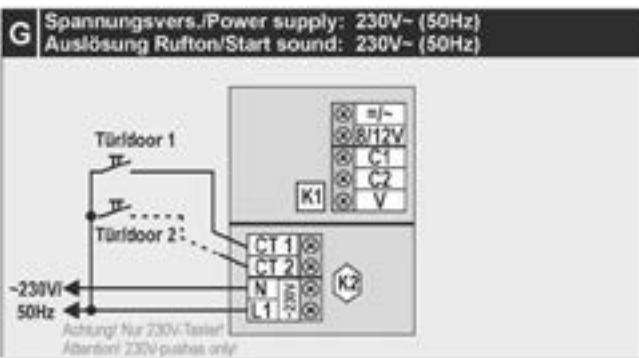
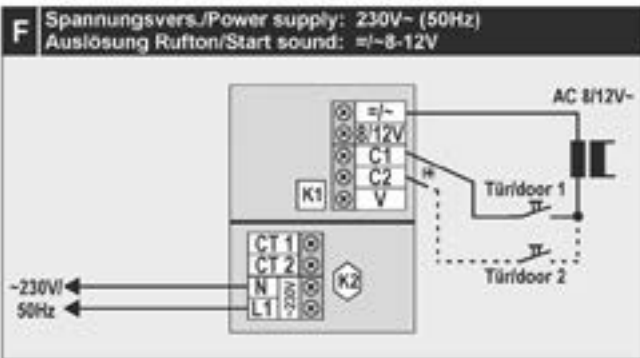
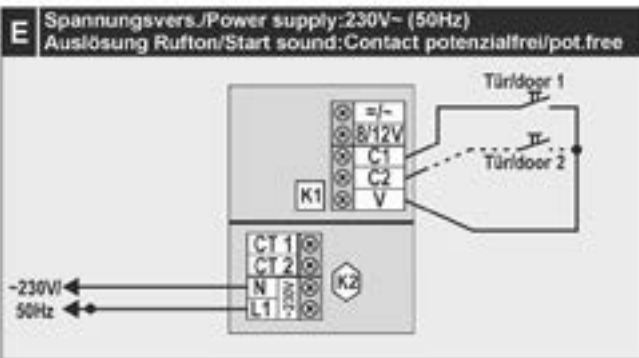
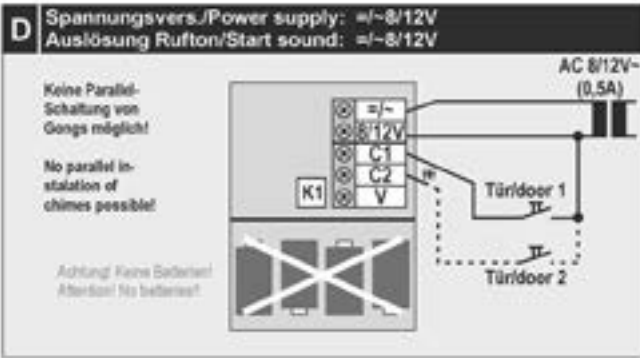
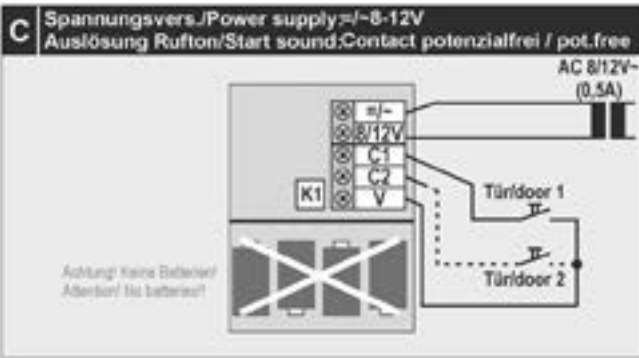
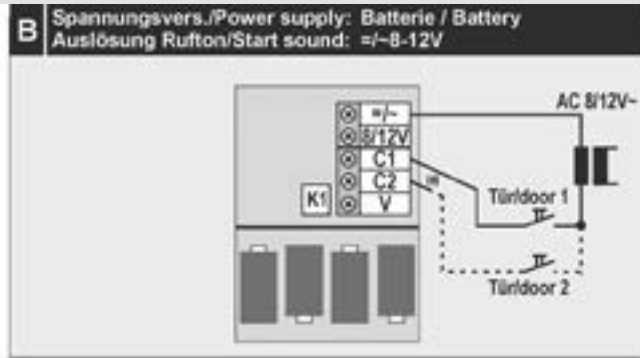
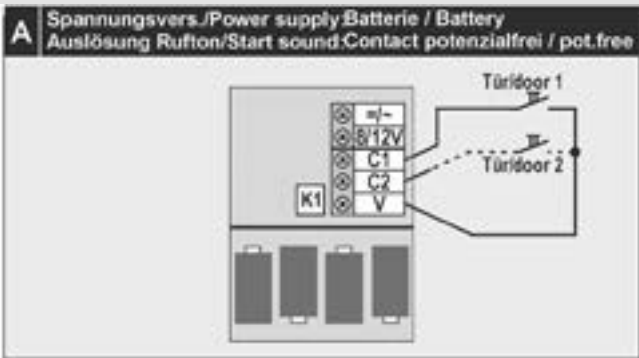

Flush mounted Series



- Installed in a flush mounted unit
- Integration in switch product ranges
- Series with flush mounted chime, bell and buzzer
- 8–12 V AC/DC, 230 V (permanent voltage)

The simple design of the flush mounted series doorbell, bell and buzzer can be integrated discretely with numerous products from leading manufacturers. Simply integrate flexibly on site.

With 17 polyphonic melodies, a volume of 83dB(A), double call differentiation as well as muting and melody selection on the front of the unit, the electronic flush mounted doorbell is a true sound and technological wonder. Everything that a doorbell should be – only in compact size.



Flush-type electronic chimes / bells / buzzers

Flush-type signalling:
 Series consisting of flush-type chime, flush-type bell mechanism and flush-type buzzer as single unit or for integration in standard switch product ranges (50x50 mm adapter frame of the switch manufacturer)

- Product features (chime)**
- 17 polyphone ring tones
 - Integration in switch product range possible

- Functions**
- Double call differentiation
 - Mute
 - Continuous volume adjustment

- Installation**
- Installation in flush-type box
 - Removable terminal makes installation easier

- Technical data**
- 80 x 80 x 40 mm (BXHXD)
 - Chime volume up to 83 dB(A)
 - volume LTW / SU up to 80 dB(A)

- Note**
- Recommendation: Use switch branching boxes (depth 60mm)
 - Supplied including mounting plate and frame



Model	Order no.	Description
UP CHIME 120ws	43701	Flush-type electronic chime <ul style="list-style-type: none"> • 17 polyphone ring tones • Mute function • cont. volume adjustment • incl. mounting plate & frame • mounting depth 31 mm • 8-12 AC/DC (0.280 A) • up to 83 dB(A) • 80 x 80 x 40 mm • Colour: white • permanent voltage
UP CHIME 230ws	43706	Flush-type electronic chime <ul style="list-style-type: none"> • as 43701 • mounting depth 31 mm • but: 230V AC, 50Hz (0.080 A) • permanent voltage
UP-LTW 120 ws	43711	Flush-type bell mechanism <ul style="list-style-type: none"> • Small bell • up to 80 db(A) • incl. mounting plate & frame • shout time operation 5/55 sec • 8-12 V AC (0.320 A) • 80 x 80 x 40 mm • Colour: white • mounting depth 31 mm
UP-LTW 230 ws	43716	Flush-type bell mechanism <ul style="list-style-type: none"> • as 43711 • shout time operation 5/55 sec • but: 230V AC, 50Hz / 0.045 A • mounting depth 31 mm
UP-SU 120 ws	43721	Flush-type buzzer <ul style="list-style-type: none"> • Small bell • up to 80 db(A) • incl. mounting plate & frame • shout time operation 5/55 sec • 8-12 V AC (0.210 A) • 80 x 80 x 40 mm • Colour: white • mounting depth 31 mm
UP-SU 230 ws	43726	Flush-type buzzer <ul style="list-style-type: none"> • as 43721 • shout time operation 5/55 sec • but: 230V AC, 50Hz / 0.036 A • mounting depth 31 mm

Flush-type Chime FT– Circuit overview

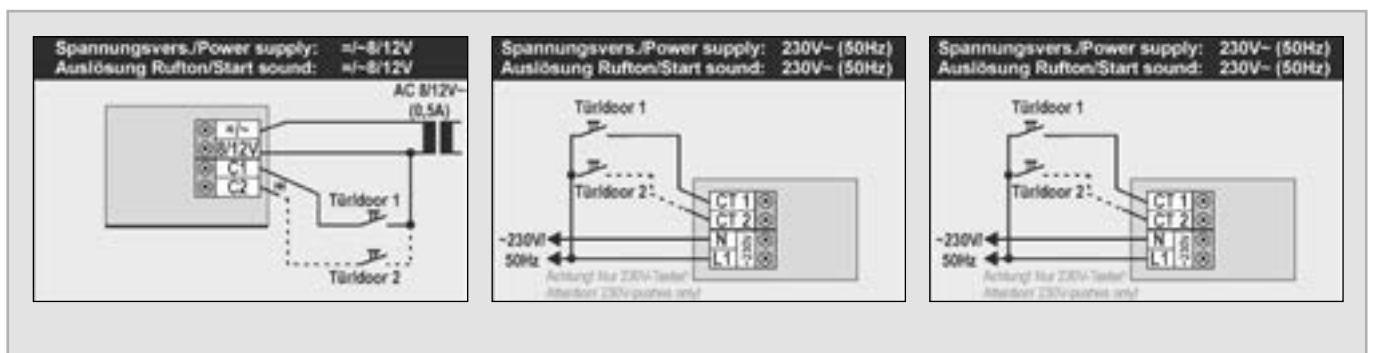



- Dual-Tone
- Bell steel sound plates
- External transformer operation
- Battery casing for a 9 V square battery (depends on model)

With its sound plates of real bell steel, the classical Grothe two-tone chime reliably ensures a clear, rich tone during signalling. Conventional technology with the highest quality and longest durability. The 8 to 12V doorbells can be operated via a transformer, but now have an additional compartment for 9 V square batteries as standard.

The 230 volt variations contain an additional transformer in order to save time during installation.

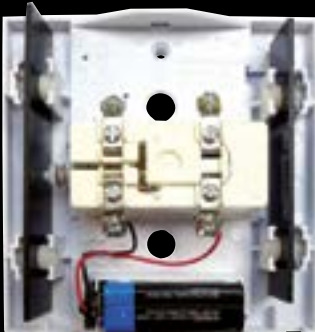

Electromechanical chimes

Model	Order no.	Description
CHIME 065 Bw	44065	Chime <ul style="list-style-type: none"> • Casing White, Front silver stainless steel effect • 8 –12 AC (12 VA) • Operation with external transformator possible • Max. 80 dB(A) • Short time load 5/15 s • Dimensions: 136 x 150 x 50 mm
CHIME 165 Bw	44165	Chime <ul style="list-style-type: none"> • Casing White • Operation with external transformator possible • Max. 80 dB(A) • Short time load 5/15 s • Dimensions: 118 x 118 x 47 mm
CHIME 169 BW	44169	Chime <ul style="list-style-type: none"> • Casing White • Operation with external transformator possible • Max. 80 dB(A) • Short time load 5/15 s • Dimensions: 169 x 104 x 49 mm
CHIME 169 DKw	44171	Chime <ul style="list-style-type: none"> • Casing White • Operation with external transformator possible • Max. 80 dB(A) • Cycle frequency approx. 2–3 Hz • Dimensions: 169 x 104 x 49 mm
CHIME 169 A TRw	44172	Chime <ul style="list-style-type: none"> • Casing White • Operation with integrated transformer • Max. 80 dB(A) • Dimensions: 169 x 104 x 49 mm
CHIME 265 w	44265	Chime <ul style="list-style-type: none"> • Casing White • Operation with external transformator possible • Max. 80 dB(A) • Short time load 5/15 s • Dimensions: 118 x 118 x 38 mm
CHIME 465A BW/sw	44465	Chime <ul style="list-style-type: none"> • Casing White, Front Black • Operation with external transformator possible • Max. 80 dB(A) • Short time load 5/15 s • Dimensions: 118 x 118 x 47 mm
CHIME 465A BW/w	44466	Chime <ul style="list-style-type: none"> • Casing Colour: white, Front: white • Operation with external transformator possible • Max. 80 dB(A) • Short time load 5/15 s • Dimensions: 118 x 118 x 47 mm
CHIME 465A-230 ws/sw	44475	Chime <ul style="list-style-type: none"> • Casing Colour: white, Front: black • Short time load 5/15 s • Max. 80 dB(A) • Dimensions: 118 x 118 x 47 mm
CHIME 465A-230 ws/ws	44476	Chime <ul style="list-style-type: none"> • Casing Colour: white, Front: white • Max. 80 dB(A) • Short time load 5/15 s • Dimensions: 118 x 118 x 47 mm
CHIME 565A Bw/sim	44565	Chime <ul style="list-style-type: none"> • Casing White • Operation with external transformator possible • Max. 80 dB(A) • Short time load 5/15 s • Dimensions: 136 x 150 x 50 mm
CHIME 569A Bw	44569	Chime <ul style="list-style-type: none"> • Casing White • Operation with external transformator possible • Max. 80 dB(A) • Short time load 5/15 s • Dimensions: 171 x 109 x 46 mm
CHIME 569-230V	44179	Chime <ul style="list-style-type: none"> • Casing White, base: black • Short time load 5/15 s • Max. 80 dB(A) • Dimensions: 170 x 105 x 50 mm
CHIME 665 Bw/bl	44665	Chime <ul style="list-style-type: none"> • Casing White • Operation with external transformator possible • Max. 80 dB(A) • Short time load 5/15 s • Dimensions: 136 x 150 x 50 mm

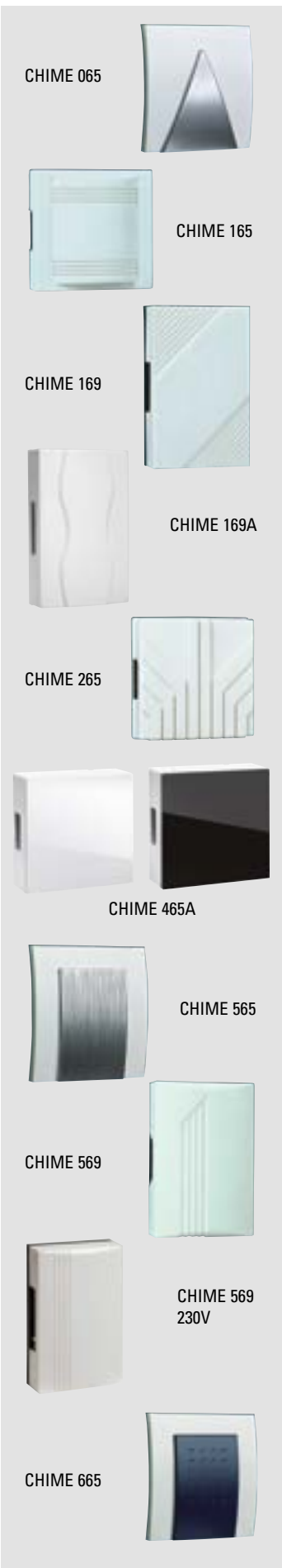

Note: Batteries are not included in the delivery

Sound devices – Bells / Buzzers / Horns



Sound devices – Bells / Buzzers / Horns

The choice is yours: the classic bell for domestic use or the professional version for industrial and commercial use!

A friendly welcome signal for visitors or a warning signal for enhanced security. GROTHE signal systems turn heads! Guaranteed! And when sheer volume is no longer enough – then it's a job for the PSG 4.0, whose ultra-bright LED flashing beacon is impossible to oversee.

Power Sound Generator 4.0



- High volume generated by the double pressure chamber loud speaker system
- Power-boost to 115 dB(A)
- Industrial, commercial or domestic use – universal.
- Table, wall or ceiling mounting (30°/60° angle)

Universally used sounder with a very high volume, many distinct signal tones and outstanding installation flexibility, for both indoor and outdoor use (e. g. schools, airports, industrial premises, public buildings, etc). The PSG can be attached to suit your requirements: Mount directly to a wall, tables or ceiling using the accessories available. Various angles of radius can also be set to suit.

No need to worry about wiring or device variants either!
The PGS 230 can do everything: Supply with either 12–24 AC/DC or 230 V AC, activation with the same voltages or potential free or criss-cross (see the installation manual for the possible options).



Power siren PSG 4.0

Model	Order no.	Description
PSG 4.0-100	37410	Power siren • Wiring options A, B, C • incl. LED flashing light • 12–24 V AC/DC (1.0 A)
PSG 4.0-230F	37430	Power siren • Incl. LED flashing light • 230 V AC (0.1 A), 12–24 V AC/DC (1.0 A) • Wiring options A, B, C, D, E, F, G, H



PSG – Circuit overview

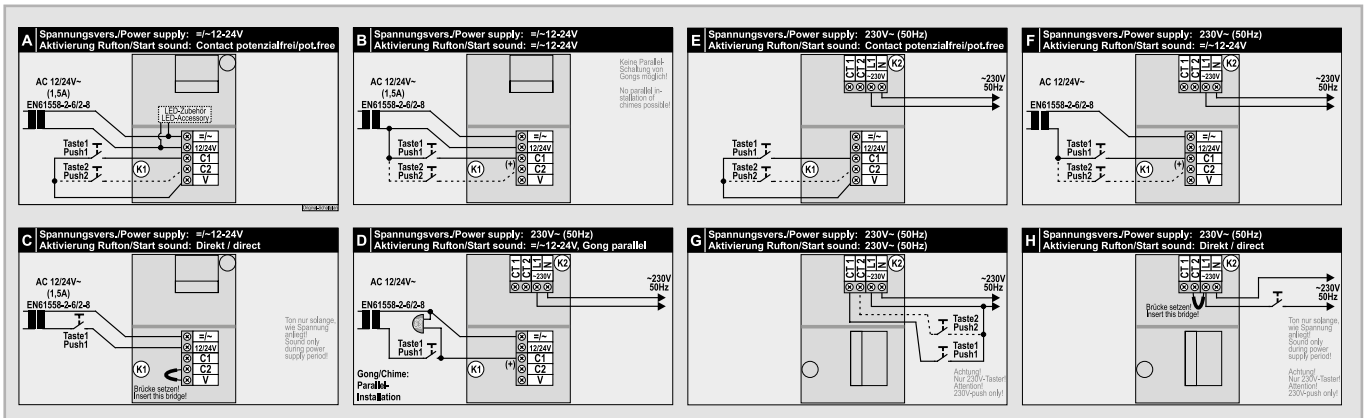

Bells



- High volume
- Robust design
- Proven technology

The mechanical bells from Grothe are characterised by their excellent sound quality. The advantage in residential applications, when compared with the classical two-tone bell, is that the sound generation continues as the bell button is pressed.

In industrial applications, the bells come into their own as danger warnings or as break signals.

Appropriate warning signals for industrial use are regulated according to international and domestic safety laws and installation is compulsory. Grothe alarm bell systems act as warnings in case of hazard where the health or safety of the worker is affected.

Small bell LTW 4477A



Large bell 742/754



Trumpf bell LTW 1171A

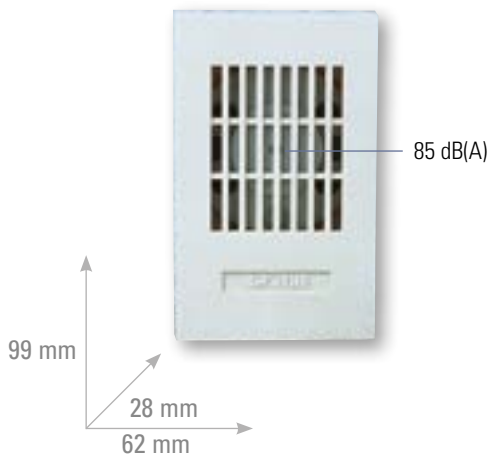

Signaller SG 851



Universal-use flush-mounted signaller with electronic alpha tone in modern installation device design

Product features

- Electronic alpha tone with subdued volume
- White plastic housing

Installation

- Flush-mounted installation (expander claw fastening or screw fastening in flush-mounting boxes)
- Parallel connection of several signallers possible

- Parallel connection to electromechanical chimes with the same rated voltage possible

Technical data

- Approx. 70 dB(A)
- For voltage variants, see ordering overview
- Degree of protection IP20
- Temperature range +5°C to 40°C
- 80 x 80 x 48 mm
- Duty cycle 100%

Model	Order no.	Description
SG 851 8-12V AC	24012	Signaller • 8–12 V AC / 50 Hz (0.45 VA)
SG 851 230V AC	24017	Signaller • 230 V AC / 50 Hz (0.90 VA)

Flush-type bell mechanism LTW / buzzer SU 120 / 230



Model	Order no.	Description
UP-LTW 120 ws	43711	Flush-type bell mechanism • Small bell • up to 80 db(A) • incl. mounting plate & frame • 8-12V AC (0.320A) • 80 x 80 x 40 mm • Colour: white
UP-LTW 230 ws	43716	Flush-type bell mechanism • as 43711 • but: 230V AC, 50Hz / 0.045
UP-SU 120 ws	43721	Flush-type buzzer • Small bell • up to 80 db(A) • incl. mounting plate & frame • 8-12V AC / 0.210 A • 80 x 80 x 40 mm • Colour: white
UP-SU 230 ws	43726	Flush-type buzzer • as 43721 • but: 230V AC, 50Hz / 0.036 A

Buzzer SU 1170A / Trumpf bell LTW 1171A



Product features

- White
- Flush-mounted installation

Technical data

- Max. 85 dB(A)
- Short-term load max. 10 s (KB 10 s)
- 99 x 62 x 28 mm

Model	Order no.	Description
SU 1170A 8-12V	24052	Buzzer • Reed-type buzzer with adjustable volume • 8–12 V AC / 0.37 A
LTW 1171A 8V AC	24081	Bell mechanism • 8 V AC / 0.83 A
LTW 1171A 12V AC	24082	Bell mechanism • 12 V AC / 0.38 A
LTW 1171A 24V AC	24083	Bell mechanism • 24 V AC / 0.17 A

Circular bell LTW 101A



Product features

- White plastic base
- Elegant tone shell

Technical data

- 85 dB(A)
- 8 V AC (0.86 A)
- Short-term load 10 s (KB 10 s)
- Shell diameter 70 mm
- 80 x 75 x 30 mm

Model	Order no.	Description
LTW 101A 8V AC	24071	Circular bell • 8 V AC (0.86 A)

Record bell LTW 1101A

Product features

- White plastic housing
- Contents of packaging: 2 items (price quotation per item)

Technical data

- 84 dB(A)
- 8 V AC (0.86 A)
- Short-term load 10 s (KB 10 s)
- Shell diameter 70 mm
- 114 x 70 x 30 mm



Model	Order no.	Description	PU
LTW 1101A 8V AC	24075	Small bell	2
			• 8 V AC(0.86 A)

Colonia bell LTW 4471A

Product features

- White plastic housing
- Contents of packaging: 2 items (price quotation per item)
- Flat shell

Technical data

- 80 dB(A)
- 8 V AC (1.0 A)
- Short-term load 10 s (KB 10 s)
- Shell diameter 70 mm
- 150 x 70 x 30 mm



Model	Order no.	Description	PU
LTW 4471A 8V AC	24111	Small bell	2
			• 8 V AC(1.0 A)

Colonia bell LTW 4477A

Product features

- White plastic casing
- Contents of packaging: 2 items (price quotation per item)

Technical data

- 8 - 12V AC (AC)
- 0,08 - 0,12 A
- Shell diameter 70 mm



Model	Order no.	Description	PU
LTW 4477A 8V AC	24113	Small bell	2
			• 85 dB(A)
			• 148 x 70 x 80 mm

Dome bell LTW 3371A

Product features

- White plastic housing
- Cover with screw fastening
- Double coil
- ÖVE-tested

Technical data

- 85 dB(A)
- 230 V AC (6 mA)
- Continuous operation
- 150 x 70 x 35 mm
- Shell diameter 70 mm



Model	Order no.	Description	PU
LTW 3371A 230V AC	24091	Small bell	2
			• 230 V AC (6 mA)

SOS alarm bell LTW 911A

Product features

- White plastic housing
- With watertight diaphragm-type grommet for cable insertion
- Tone shell made of painted steel

Technical data

- 98 dB(A)
- Short-term load 10 s (KB 10 s)
- 210 x 100 x 51 mm
- Shell diameter 100 mm
- Degree of protection IP54



Model	Order no.	Description	PU
LTW 911A 8V AC F	24311	Bell	2
			• 8 V (0.6 A)
LTW 911A 24V AC	24331	Bell	2
			• 24 V (0.23 A)
LTW 911A 230V AC	24376	Bell	2
			• With fine-wire fuse (0.05 A)
			• 230 V (0.025 A)

Large bells LTW 742 / 754



Product features

- Light-grey, impact-resistant, plastic housing
- With watertight diaphragm-type grommet for cable insertion
- Tone shell made of powder-coated cast steel, hammer finish

Technical data

- Degree of protection IP54 (outdoor use)
- 105 dB(A)
- 260 x 155 x 100 mm
- Shell diameter 150 mm
- Fastening hole spacing 136 mm

Model	Order no.	Description
LTW 742 12V AC	22512	Large bell • Continuous operation • 12 V AC (1.2 A)
LTW 742 24V AC	22513	Large bell • Continuous operation • 24 V AC (0.6 A)
LTW 742 42V AC	22514	Large bell • Continuous operation • 42 V AC (0.5 A)
LTW 742 230V AC	22517	Large bell • Continuous operation • VDE-tested • 230 V AC (0.05 A) • 50 Hz
LTW 754 12V/DC	22540	Large bell • Not suitable for installation in new automobiles (from year of manufacture 2002) (for technical authorisation purposes, not suitable for vehicles manufactured from 2002 on) • Intermittent operation 5/5 min • 12 V= (1.0 A)
LTW 754 24V/DC	22541	Large bell • Not suitable for installation in new automobiles (from year of manufacture 2002) (for technical authorisation purposes, not suitable for vehicles manufactured from 2002 on) • Intermittent operation 5/5 min • 24 V= (0.9 A)

Large bells LTW 781 / 793



Product features

- Light-grey impact-resistant plastic cover
- Sturdy cast steel housing
- With watertight diaphragm-type grommet for cable insertion
- Tone shell made of powder-coated cast steel, hammer finish

Technical data

- Degree of protection IP54 (outdoor use)
- DIN VDE 0700 / EN 60335-tested
- 110 dB(A)
- 360 x 250 x 110 mm
- Shell diameter 250 mm
- Fastening hole spacing 132 mm

Model	Order no.	Description
LTW 781 230V AC	22557	Large bell • Continuous operation • 230 V AC (0.05 A) • 50 Hz
LTW 793 12V/DC	22580	Large bell • Not suitable for installation in new automobiles (from year of manufacture 2002) (for technical authorisation purposes, not suitable for vehicles manufactured from 2002 on) • Intermittent operation 5/5 min • 12 V= (1.0 A)
LTW 793 24V/DC	22581	Large bell • Not suitable for installation in new automobiles (from year of manufacture 2002) (for technical authorisation purposes, not suitable for vehicles manufactured from 2002 on) • Intermittent operation 5/5 min • 24 V= (0.9 A)

Horns



- Compact high volume horns for indoor and outdoor use
- Volume of up to 100 dB(A)
- Industrial, commercial or domestic use
- Combihorn with integrated warning light

Due to an electromechanical sound produced through a membrane, horns are the ideal devices for warning signal for use in industry, as alarm systems or fire protection technology. Using a funnel for optimal sound focusing, Grothe horns can achieve up to 100 dB(A).

Also available in the programme is the so-called combi-horn, which not only emits an acoustic signal, but also a visual signal.

HORN 640



White, impact-resistant plastic casing, with funnel
Degree of protection IP54

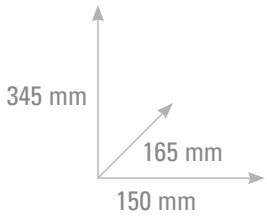

100 dB(A)

HORN 680



Aluminium casing with grey
hammer finish
Degree of protection IP54

HORN WL 63xx



Integrated warning light with
standard bulb 5 W for socket Ba 15d
or
SMD LED technology
Degree of protection IP43

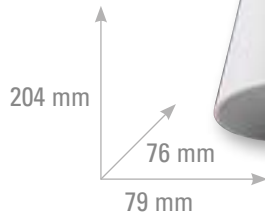

from 92 dB(A)

HORN 63x



Solid, light grey plastic casing
Degree of protection IP43

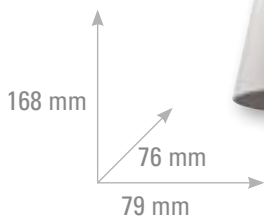

92 dB(A)

100 dB(A)

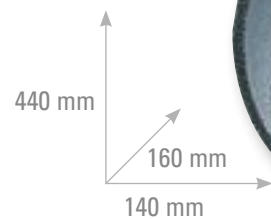

Horn 63x

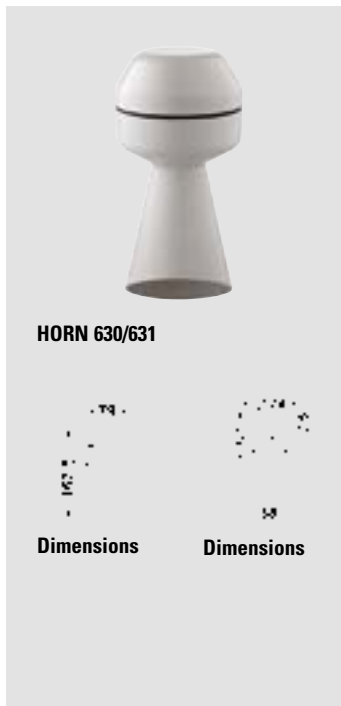

Compact horn with high volume for indoors and outdoors

Product features

- Electromechanical sound generation with a steel diaphragm
- With bell mouth for optimum sound concentration
- Sturdy light-grey plastic housing (ABS, self-extinguishing)

Installation

- Wall mounting (with bell mouth facing down)
- Terminals for max. 1.5 mm²

Technical data

- Duty cycle 100%
- Degree of protection IP43, protection class II
- -30°C to +50°C
- 168 x 79 x 74
- Weight 0.2 kg

Model	Order no.	Description
For alternating current (AC)		
HORN 630 8V AC	31041	Horn • 8 V DC (0.34 A), 92 dB(A)
HORN 630 24V AC	31043	Horn • 24 V AC (0.14 A), 93 dB(A)
HORN 630 110V AC	31045	Horn • 110 V AC (0.06 A) 95 dB(A)
HORN 630 240V AC	31047	Horn • 240 V AC (0.03 A), 95 dB(A)
For direct current (DC)		
HORN 631 12/24 V DC	31053	Horn • 12 V DC (0.05 A), 90 dB(A) • 24 V DC (0.14 A), 92 dB(A)

Horn WL 63xx

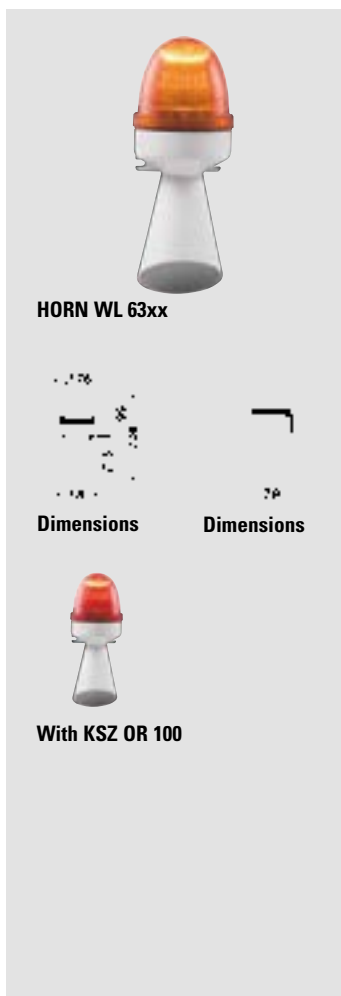

Compact horn with high volume and an additional visual signaller for indoors and outdoors

Product features

- Electromechanical sound generation with a steel diaphragm
- With integrated warning light
- Orange lens made of impact-resistant polycarbonate PC (red lens as accessory 31101)
- Duration of optic / acoustic signals as long as voltage applied (use an additional relay if required); operation of the optical signal independently of the acoustic signal possible
- With bell mouth for optimum sound concentration
- Sturdy light-grey plastic housing (ABS, self-extinguishing)

Installation

- Wall mounting (with bell mouth facing down)
- Terminals for max. 1.5 mm²

Technical data

- Duty cycle 100%
- Incl. 5W bulb for Ba15d socket
- Degree of protection IP43, protection class II
- -30 °C to +50°C
- 204 x 79 x 76
- Weight 0.25 kg
- Important: Please order LED-lamps separately

Model	Order no.	Description
HORN WL 6301 240V AC	31371	Combi horn • 240 V AC (0.06 A), 92 dB(A)
HORN WL 6311 24V DC	31341	Combi horn • 24 V DC (0.25 A), 96 dB(A)
Accessories/Spare parts		
KSZ 8596	38596	Bulb • For Ba15d socket • 24 V (5 W)
KSZ 8597	38597	Bulb • For Ba15d socket • 240 V (5 W)
KSZ OR 100	31101	Lens • Red

LED light			
for 24 V AC/DC			
KSZ-LED 8661	38661	LED light	Yellow-orange 24 V AC/DC (45 mA)
KSZ-LED 8662	38662	LED light	Red 24 V AC/DC (45 mA)
for 240 V AC			
KSZ-LED 8651	38651	LED light	Yellow-orange 230–240 V AC (50 mA)
KSZ-LED 8652	38652	LED light	Red 230–240 V AC (50 mA)

Horn BZ 63xx

Compact horn with high volume and an additional visual signaller for indoors and outdoors

Product features

- High warning effect thanks to xenon flash tube (included in scope of delivery)
- Orange lens made of impact-resistant polycarbonate PC (red lens as accessory 31101)
- High failure safety of the optical signaller as there are no moved parts
- Field of application: industrial hazard areas/alarm systems
- Electromechanical sound generation with a steel diaphragm
- Duration of optical/acoustic signals as long as voltage applied (use an additional relay if required); operation of the optical signal only possible together with acoustic signal

- With bell mouth for optimum sound concentration
- Sturdy light-grey plastic housing (ABS, self-extinguishing)

Installation

- Wall mounting (with bell mouth facing down)
- Terminals for max. 1.5 mm²

Technical data

- Duty cycle 100%
- Replaceable xenon tube 2 j
- Flash frequency: dual flash, 2x65 flashes/min.
- Degree of protection IP43, protection class II
- -30 °C to +40 °C
- 204 x 79 x 76
- Weight 0.25 kg

Model	Order no.	Description
HORN BZ 6301 240 V AC	31271	Combi horn <ul style="list-style-type: none"> • 240 V AC (0.05 A) • 92 dB(A)
HORN BZ 6311 24 V DC	31241	Combi horn <ul style="list-style-type: none"> • 24 V DC (0.65 A) • 96 dB(A)
Accessories / Spare parts		
KSZ OR 100	31101	Lens <ul style="list-style-type: none"> • Red

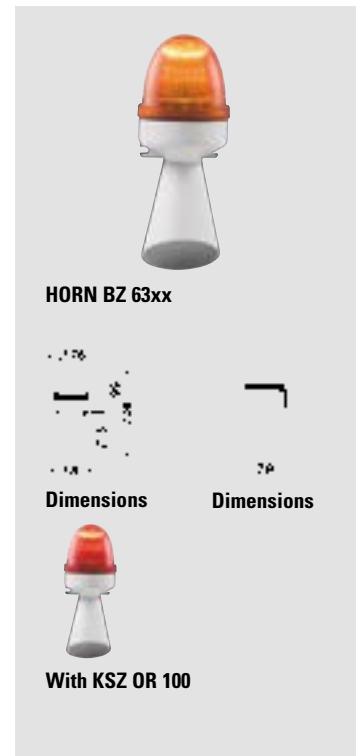

Horn 640 / 651

Product features

- White impact-resistant plastic housing, with bell mouth
- With watertight diaphragm-type grommet for cable insertion

Technical data

- 100 dB(A)
- 345 x 150 x 165 mm
- Degree of protection IP54 (outdoor use)
- -10 °C to +50 °C

Model	Order no.	Description
HORN 640 12 V AC	32012	Large horn <ul style="list-style-type: none"> • Continuous operation • 12 V AC (2.2 A)
HORN 640 24 V AC	32013	Large horn <ul style="list-style-type: none"> • Continuous operation • 24 V AC (1.1 A)
HORN 640 230 V AC	32017	Large horn <ul style="list-style-type: none"> • Continuous operation DIN 0700-tested • 230 V AC, 50 Hz (0.15 A)
HORN 651 24 V DC	32123	Large horn <ul style="list-style-type: none"> • Continuous operation 5/5 min • 24 V DC (0.4 A)



Horn 680

Product features

- Light-metal housing with grey hammer finish
- Suppressed
- With bell mouth
- With watertight diaphragm-type grommet for cable insertion

Technical data

- 230 V AC (0.15 A)
- 50 Hz (60 Hz on request)
- 100 dB(A)
- Continuous operation
- Degree of protection IP54 (outdoor use)
- DIN VDE 0700 / EN 60335-tested
- 440 x 140 x 160 mm
- -10 °C to +50 °C

Model	Order no.	Description
HORN 680 230V AC	33017	Large horn



Optical and Acoustic Signalling Devices

»A signal simply had to be set here«

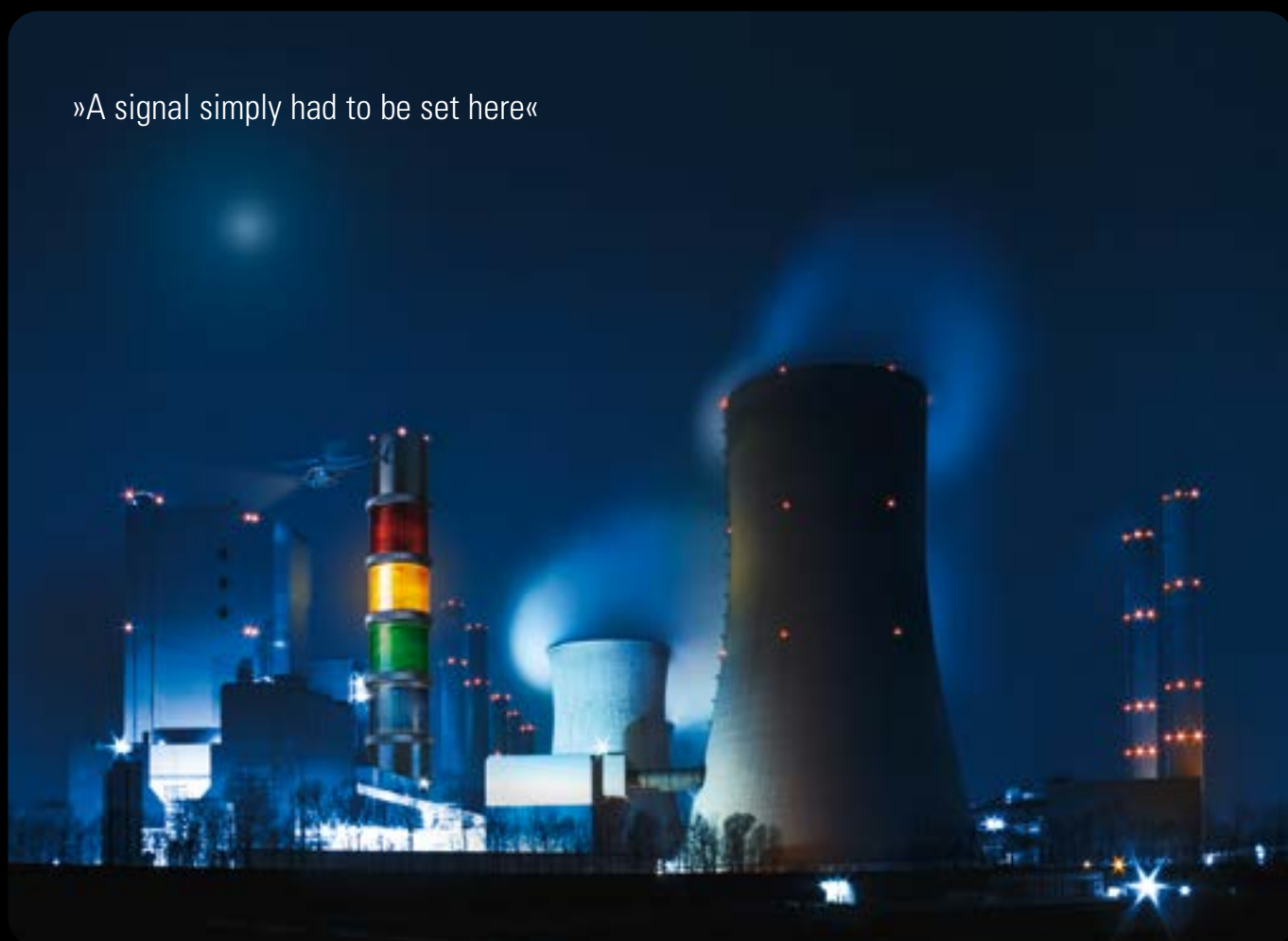

Optical and Acoustic Signalling Devices

Can be ideally adapted for use in industrial and commercial conditions and combined to suit!

The optical acoustic combinations „System T“ and „System T-Mini“ are, as modular systems, also fast to install and fit extremely well in the modern industrial environment. The universally applicable rotating mirror beacons with a wide selection of different light sources round off the programme perfectly.



- Module system T
- Module system M
- Warning and strobe lights
- Rotating mirror lights
- Rotating beacons

Define the appropriate signal for each (dangerous) situation and combine them with different colours and light combinations according to taste with the visual and acoustic signal devices from the Grothe company.

Whether you would like to install an individual warning light, or a column system, or rotating mirror light on the wall or a flat surface: You will always find the matching accessory.

System T (Ø 75 mm) / System T-mini (Ø 48 mm)

Compact modular beacon post with innovative, long-life LED technology and high light intensity for many applications for indoor and outdoor use.

Small warning and flashing light (Ø 76 mm)

Small cheap warning light for use with standard bulb in standard operating environments

Can be fitted to assembly bracket KSZ 8604/8605

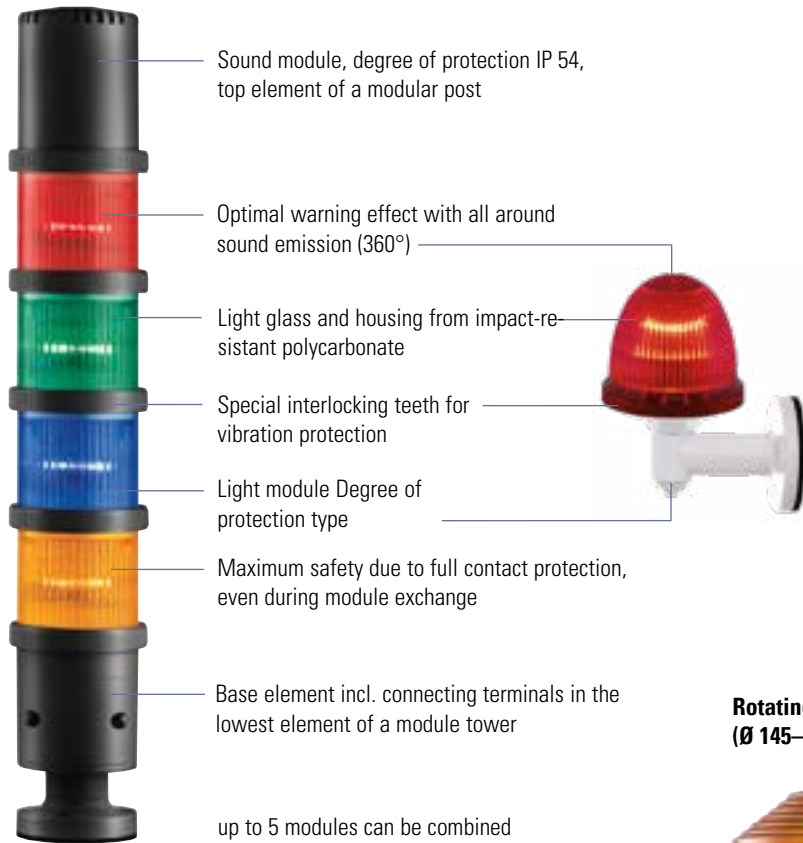

Large warning and strobe light (Ø 138 mm)



Mid-sized strobe light (Ø 96 mm)



Fixation onto horizontal or vertical surfaces
Including mounting seal
Degree of protection IP54 / protection class II

System M (Ø 92 mm)

System M is a compact, modular system consisting of basic modules, lighting and sound generators, which with its high optical performance and powerful sound makes the system a solution for all demanding applications. With the Sound module for very high protection (IP65), System M is ideal for outdoor applications.

The multi-stage technology allows the execution of different alert levels with a single device. This is the choice between different sounds, lights and flash.

Sound module, degree of protection IP65



Sound module based on module for wall mounting, degree of protection IP65



LED-combi-module on based module (flat) for surface mounting, degree of protection IP65



LED warning light on based module (deep) for surface mounting, degree of protection IP65



Rotating mirror beacon (Ø 145–152 mm)



High quality rotating mirror beacon with a halogen system for optimal light yield

Fixation onto horizontal surfaces

Ball-bearing mounted reflector made of corrosion resistant metal

Long-life gearwheel drive with life time seal

Optimal light yield with halogen, xenon or standard bulbs

Degree of protection IP55 / protection class II

System M



BMF 8911



**BMT8912
BMT 8914**



**BMW 8913
BMW 8915**



**BDW 8916
BDW 8917**



BMF 8991



**BMT 8992
BMT 8994**



**BME 8993
BME 8995**

Product features

- For all types 389x
- Multi-volt-mode
- Material: Black PC plastic

Technical data

- -30°C to +50°C

Model	Order no.	Description
BMF 8911	38911	Basic module wall • diameter 92 x 22 mm • suspended ceilings installation • 12/24 V AC/DC
BMT 8912	38912	Basic module wall • diameter 92 x 47 mm • suspended ceilings installation • 12/24 V AC/DC • M20 screw connection
BMW 8913	38913	Basic module wall • 100 x 61 x 115 mm • On wall installation • 12/24 V AC/DC
BMT 8914	38914	Basic module wall • diameter 92 x 47 mm • suspended ceilings installation • 90 - 240 V AC • M20 screw connection
BMW 8915	38915	Basic module wall • 100 x 61 x 115 mm • On wall installation • 90 - 240 V AC
BDW 8916	38916	Basic module wall • 100 x 95 x 115 mm • On wall installation • 112/24 V AC/DC
BDW 8917	38917	Basic module wall • 100 x 95 x 115 mm • On wall installation • 90 - 240 V AC
BMF 8991	38991	Basic module wall • diameter 92 x 22 mm • On wall installation • 12/24 V AC/DC
BMT 8992	38992	Basic module wall • diameter 92 x 47 mm • On wall installation • 12/24 V AC/DC

Product features

- For all types 389x
- Multi-volt-mode
- Material: White PC plastic

Technical data

- -30°C to +50°C

Model	Order no.	Description
BMT 8993	38993	Basic module wall • 100 x 95 x 115 mm • suspended ceilings installation • 12/24 V AC/DC • M20 screw connection
BMW 8994	38994	Basic module wall • diameter 145 x 70 mm • On wall installation • suspended ceilings installation • 12/24 V AC/DC • Flush mounted installation
BMT 8995	38995	Basic module wall • diameter 145 x 70 mm • suspended ceilings installation • 90 - 240 V AC • Flush mounted installation

System M

Product features

- For Multi-volt-basic-modules
- 2 functions (alarm 1, alarm 2)
- Independent control through different contacts
- Alarm 1: 64 tones selectable by DIP switch A
- Alarm 2: 64 tones selectable by DIP switch B

Technical data

- Multi-volt-mode
- max. 105dB(A)
- Duty cycle 100%
- -30°C to +50°C
- Diameter 92 x 63mm
- Degree of protection IP65, protection class II

Model	Order no.	Description
MSG 8921	38921	Module sounder • Material: Black plastic
MSG 8922	38922	Module sounder • Material: White plastic

Product features

- For Multi-volt-basic-modules
- 3 functions (warning, alarm 1 and alarm 2)
- Independent control through different contacts
- Warning: triple stroboscope flash effect
- Alarm 1: triple stroboscope flash effect and 64 tones selectable by DIP switch A
- Alarm 2: powerful warning light and 64 tones selectable by DIP switch B

Technical data

- Multi-volt-mode
- Flash frequency ca. 85/min
- max. 105dB(A)
- -30°C to +50°C
- Diameter 92 x 63mm
- Degree of protection IP65, protection class II

Model	Order no.	Description
MHZ 8931	38931	Module-multistrobe-LED Lamp • Orange • 15 Cd(p)
MHZ 8932	38932	Module-multistrobe-LED Lamp • Red • 10Cd(p)
MHZ 8933	38933	Module-multistrobe-LED Lamp • Green • 20Cd(p)
MHZ 8934	38934	Module-multistrobe-LED Lamp • Blue • 5Cd(p)

Product features

- For Multi-volt-basic-modules
- 3 functions (continuous, rotating and flash)
- Independent control through different contacts

- Flash frequency ca. 85/min
- Rotation frequency ca. 140/min
- Duty cycle 100%
- max. 105dB(A)
- -30°C to +50°C
- Diameter 92 x 126mm
- Degree of protection IP65, protection class II

Technical data

- Multi-volt-mode

Model	Order no.	Description
MWL 8941	38941	Module-warning-LED Lamp • Orange • 20Cd(p)
MWL 8942	38942	Module-warning-LED Lamp • Red • 13Cd(p)
MWL 8943	38943	Module-warning-LED Lamp • Green • 16Cd(p)
MWL 8944	38944	Module-warning-LED Lamp • Blue • 5Cd(p)

Product features

- For Multi-volt-basic-modules
- 3 functions (permanent, flash, double flash)
- Independant control through different contacts

Technical data

- Multi-volt-mode
- Flash frequency ca. 140/min
- Duty cycle 100%
- -30°C to +50°C
- Diameter 92 x 43mm
- Degree of protection IP65, protection class II

Model	Order no.	Description
MWL 8951	38951	Module warning LED lamp • Orange • 20 CDd(p)
MWL 8952	38952	Module-warning-LED Lamp • Red • 13 CDd(p)
MWL 8953	38953	Module-warning-LED Lamp • Green • 16 CDd(p)
MWL 8954	38954	Module-warning-LED Lamp • Blue • 5 CDd(p)



MSG 8921



MSG 8922



MSG 8931



MSG 8932



MSG 8933



MSG 8934



MWL 8941



MWL 8942



MWL 8943



MWL 8944



MWL 8951



MWL 8952



MWL 8953



MWL 8954

System M

Product features

- For Multi-volt-basic-modules
- 3 functions (permanent, flash, double flash)
- Independant control through different contacts

Technical data

- Multi-volt-mode
- Max. 20 Cd(p)
- Duty cycle 100 %
- -30 to +50 °C
- Diameter 92 x 43mm
- Degree of protection IP66, protection class II
- Blinking frequency 140/minute

Model	Order no.	Description
MML 8963	38963	Module-warning-LED Lamp <ul style="list-style-type: none"> • for signaling over longer distances • Integrated colours: red, orange, green, yellow, cyan, magenta, blue
MML 8962	38962	Module-warning-LED Lamp <ul style="list-style-type: none"> • for signalisation at close range • Integrated colours: red, orange, green

Product features

- For all types 389x
- Multi-volt-mode
- Material: PC gray plastic
- On wall installation

Technical data

- -25°C to +50°C

Model	Order no.	Description
AMP 8906	38906	Basic traffic lights 2 modules <ul style="list-style-type: none"> • 12 – 24 V AC/DC • Diameter 231 x 120 x 133 mm
AMP 8907	38907	Basic traffic lights 2 modules <ul style="list-style-type: none"> • 120 – 240 V AC • Diameter 231 x 120 x 133 mm
AMP 8908	38908	Basic traffic lights 3 modules <ul style="list-style-type: none"> • 12 – 24 V AC/DC • Diameter 342 x 120 x 133 mm
AMP 8909	38909	Basic traffic lights 3 modules <ul style="list-style-type: none"> • 120 – 240 V AC • Diameter 342 x 120 x 133 mm

Model	Order no.	Description
AMP 8966	38966	Traffic light module incl. 2 LED warning lamps consisting of: <ul style="list-style-type: none"> • 1x Base traffic lights module AMP 8906 • 1x Modul warning lamps LED MWL 8952 • 1x Modul warning lamps LED MWL 8953
AMP 8967	38967	Traffic light module incl. 2 LED warning lamps consisting of: <ul style="list-style-type: none"> • 1x Base traffic lights module AMP 8907 • 1x Warning lamps LED MWL 8952 • 1x Warning lamps LED MWL 8953
AMP 8968	38968	Signal module incl. 3 LED warning lamps consisting of: <ul style="list-style-type: none"> • 1x Base traffic lights module AMP 8908 • 1x Warning lamps LED MWL 8951 • 1x Warning lamps LED MWL 8952 • 1x Warning lamps LED MWL 8953
AMP 8969	38969	Traffic lights incl. LED warning lamps consisting of: <ul style="list-style-type: none"> • 1x Base traffic lights module AMP 8908 • 1x Warning lamps LED MWL 8951 • 1x Warning lamps LED MWL 8952 • 1x Warning lamps LED MWL 8953
AMP 8910	38910	Mount <ul style="list-style-type: none"> • for AMP 89xx • Swivelling • Dimensions: 136 x 88 x 30 mm • Metal



MML 8961



MML 8962



AMP 8906 / 8907



AMP 8908 / 8909



AMP 8966 / 8967



AMP 8968 / 8969



WHA 8910

Product features

- 2 functions
- Flush mounted installation (warning, alarm)
- Independent control through different contacts
- Warning: 12 tones selectable by DIP switch
- Alarm : fixed tone
- Diameter 92 x 102mm
- Flush mounted installation

Technical data

- max. 105dB(A)
- Duty cycle 100%
- -30°C to +50°C
- Diameter 92 x 102mm
- Degree of protection IP65, protection class II

Sirens

Model	Order no.	Description
SIR 8901RT	38901	Electronic siren <ul style="list-style-type: none"> • 12/24 V AC/DC (215/250 mA) • Material: Red Plastic
SIR 8902WS	38902	Electronic siren <ul style="list-style-type: none"> • 12/24 V AC/DC (215/250 mA) • Material: White Plastic
SIR 8903RT	38903	Electronic siren <ul style="list-style-type: none"> • 90 - 240 V AC (35 - 60 mA) • Material: Red Plastic
SIR 8904WS	38904	Electronic siren <ul style="list-style-type: none"> • 90 - 240 V AC (35 - 60 mA) • Material: Red Plastic



**SIR 8901RT
SIR 8903RT**

**SIR 8902WS
SIR 8904WS**

System T

Basic unit



Product features

- Bottom unit of stacking beacon
- Incl. cover for the top unit
- Incl. EPDM seal for degree of protection IP65
- Incl. base seal
- Black housing made from impact-resistant polycarbonate PC; circuit board: FR4
- Weight 0.12 kg
- Incl. 6-way terminal for max. 2.5 mm²
- The basic unit can be screwed directly onto horizontal surfaces or combined with mounting accessories

Model	Order no.	Description
TSZ 8600	38600	Basic unit

System T

Mounting parts



Product features

- For mounting on horizontal or vertical surfaces
- Incl. O ring for degree of protection IP65
- Material: Plastic PA 66
- Mounting base with 4 fixing holes for a strong hold and base seal

Model	Order no.	Description
KSZ 8601	38601	Mounting base <ul style="list-style-type: none"> • For horizontal mounting • Male thread • Weight 0.03 kg
KSZ 8603	38603	Extension tube <ul style="list-style-type: none"> • 100 mm extension • Diameter 25 mm • Weight 0.03 kg
KSZ 8604	38604	Mounting bracket <ul style="list-style-type: none"> • For vertical mounting • (wall mounting) • 1 connection • Weight 0.04 kg
KSZ 8605	38605	Mounting bracket <ul style="list-style-type: none"> • Vertical mounting • 2 connections • Weight 0.05 kg

System T

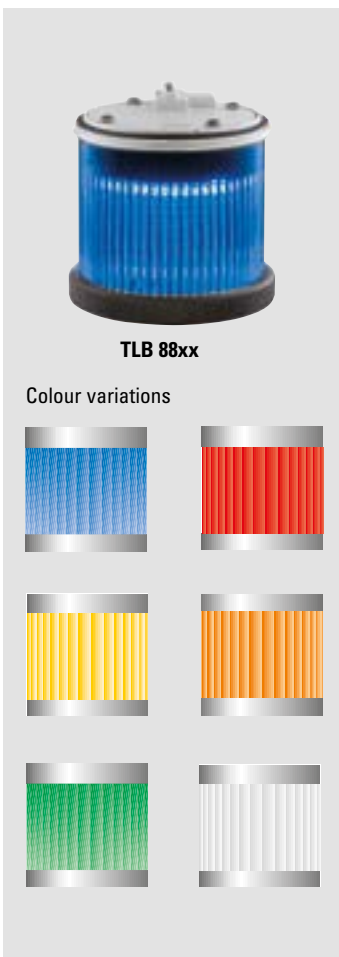

Extremely reliable flashing light module with high luminosity

Product features

- Good warning effect with even, all-round visibility (360°)
- Lenses and housing made from impact-resistant polycarbonate PC (self-extinguishing); circuit board: FR4
- Incl. bayonet closure with special interlocking teeth to prevent vibration
- Maximum safety thanks to full contact protection (even when modules are replaced)
- integrated super bright SMD LEDs
- highest reliability
- Functions: Permanent light, simple, double (xenon effect) or triple strobe adjustable using the DIP switch
- Maintenance-free, low power consumption

Technical data

- 24 V AC/DC (0.09 A)
- Duty cycle 100%
- Blink frequency approx. 150/min
- -30°C to +60°C
- Diameter 75 x 79 mm
- Weight 0,1 kg
- Degree of protection IP65, protection class II

Model	Order no.	Description
24 V AC/DC (0.09 A)		
TLB 8831	38831	LED multi flashing light <ul style="list-style-type: none"> • Orange • 5 Cd(p)
TLB 8832	38832	LED multi flashing light <ul style="list-style-type: none"> • Red • 3 Cd(p)
TLB 8834	38834	LED multi flashing light <ul style="list-style-type: none"> • Clear • 11 Cd(p)
TLB 8835	38835	LED multi flashing light <ul style="list-style-type: none"> • Blue • 1 Cd(p)
TLB 8836	38836	LED multi flashing light <ul style="list-style-type: none"> • Green • 7 Cd(p)
TLB 8837	38837	LED multi flashing light <ul style="list-style-type: none"> • Yellow • 5 Cd(p)

LED multi flashing light

System T

Model	Order no.	Description
240 V AC (0.02 A)		
TLB 8841	38841	LED multi flashing light • Orange • 5 Cd(p)
TLB 8842	38842	LED multi flashing light • Red • 3 Cd(p)
TLB 8844	38844	LED multi flashing light • Clear • 11 Cd(p)
TLB 8845	38845	LED multi flashing light • Blue • 1 Cd(p)
TLB 8846	38846	LED multi flashing light • Green • 7 Cd(p)
TLB 8847	38847	LED multi flashing light • Yellow • 5 Cd(p)

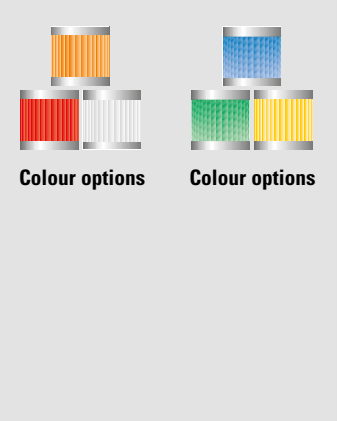

Caution: Please always order the basic unit (Order No. 38600) and mounting parts separately!

Warning light

System T

Extremely reliable flashing light module with high luminosity

Product features

- Good warning effect with even, all-round visibility (360°)
- Lenses and housing made from impact-resistant polycarbonate PC (self-extinguishing); circuit board: FR4
- Incl. bayonet closure with special interlocking teeth to pre-vent vibration
- Maximum safety thanks to full contact protection (even when modules are replaced)
- Accepts 12 to 240 V (5 W) filament bulbs and LED lights

Technical data

- 24 V AC/DC (0.09 A)
- Max. 240 V AC/DC (5 W)
- Socket: Ba15d
- Duty cycle 100 %
- Degree of protection IP65, protection class II
- -30 °C to +60 °C
- Diameter 75 mm x 79 mm
- Weight 0.09 kg



TWL 87xx

Model	Order no.	Description
TWL 8711	38711	Warning light • Orange • 3 Cd(p)
TWL 8712	38712	Warning light • Red • 1 Cd(p)
TWL 8714	38714	Warning light • Clear • 3 Cd(p)
TWL 8715	38715	Warning light • Blue • 1 Cd(p)
TWL 8716	38716	Warning light • Green • 1 Cd(p)
TWL 8717	38717	Warning light • Yellow • 3 Cd(p)

Caution: Please always order the basic unit (Order No. 38600) and mounting parts separately!

Please order filament bulbs and LED lights separately!

System T

Flashing light



TBL 872x / 873 x

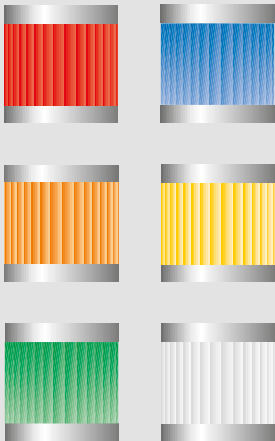

Colour options

Product features

- Good warning effect with even, all-round visibility (360°)
- Lenses and housing made from impact-resistant polycarbonate PC (self-extinguishing); circuit board: FR4
- Incl. bayonet closure with special interlocking teeth to pre-vent vibration
- Maximum safety thanks to full contact protection (even when modules are replaced)

Technical data

- Socket: Ba15D
- Flash frequency approx. 110/min.
- Duty cycle 100 %
- Degree of protection IP65, protection class II
- -30°C to +60°C
- Diameter 75 mm x 79 mm
- Weight 0.1 kg

Model	Order no.	Description
12 - 48 V DC (0.43 - 0.21 A)		
TBL 8721	38721	Flashing light • Orange • 3 Cd(p)
TBL 8722	38722	Flashing light • Red • 1 Cd(p)
TBL 8724	38724	Flashing light • Clear • 3 Cd(p)
TBL 8725	38725	Flashing light • Blue • 1 Cd(p)
TBL 8726	38726	Flashing light • Green • 1 Cd(p)
TBL 8727	38727	Flashing light • Yellow • 1 Cd(p)
24 / 240 V AC (0.21 A)		
TBL 8731	38731	Flashing light • Orange • 3 Cd(p)
TBL 8732	38732	Flashing light • Red • 1 Cd(p)
TBL 8734	38734	Flashing light • Clear • 3 Cd(p)
TBL 8735	38735	Flashing light • Blue • 1 Cd(p)
TBL 8736	38736	Flashing light • Green • 1 Cd(p)
TBL 8737	38737	Flashing light • Yellow • 3 Cd(p)

Caution: Please always order the basic unit (Order No. 38600) and mounting parts separately!
Please order filament bulbs and LED's separately!

System T

Sounder TSG 8785/6



TSG 8785/6

An inexpensive sounder for standard applications

Product features

- 6 tone sequences selectable by DIP switch
- Tone sequences: continuous, slow pulsed or rapid pulsed tone
- Reliable magneto-dynamic system for sound generation
- Incl. bayonet closure with special interlocking teeth to pre-vent vibration
- Maximum safety thanks to full contact protection (even when modules are replaced)
- The top unit of a stacking beacon (so 1 sounder per beacon is possible)

- Duration of acoustic signals as long as voltage applied (use an additional relay if required)

Technical data

- For voltages see ordering overview
- Max. 81 dB(A)
- Duty cycle 100%
- Degree of protection IP54, protection class II
- -30°C to +60°C
- Diameter 75 mm x 116 mm
- Weight 0.13 kg
- Adjustable volume

Model	Order no.	Description
TSG 8785	38785	Sounder • 12 - 48 V AC/DC (3 - 13 mA)
TSG 8786	38786	Sounder • 24 - 240 V AC (max. 8 mA)

Sounder TSG 8781/2

System T

A multifunction sounder with extremely high volume

Product features

- 32 tone sequences selectable by DIP switch
- Tone sequences/frequencies: see table below
- Reliable magneto-dynamic system for sound generation
- High acoustic pressure with low current consumption
- Incl. bayonet closure with special interlocking teeth to prevent vibration
- Maximum safety thanks to full contact protection (even when modules are replaced)
- The top unit of a stacking beacon (so 1 sounder per beacon is possible)

- Duration of acoustic signals as long as voltage applied (use an additional relay if required)

Technical data

- For voltages see ordering overview
- Max. 100 dB(A)
- Duty cycle 100%
- Degree of protection IP54, protection class II
- -30°C to +60°C
- Diameter 75 mm x 116 mm
- Weight 0.24 kg
- Adjustable volume and volume progression



Model	Order no.	Description
TSG 8781	38781	Sounder • 12 V/24 VAC/DC (0.4/1.0 A)
TSG 8782	38782	Sounder • 240 V AC (0.044 A)

TSG 8781/2 / Tone table

System T

Tone	Volume at 24 V	Frequency	Tone	Volume at 24 V	Frequency
Linear			Multitone		
Type A	94 dB(A)	1000 Hz	Normal	98 dB(A)	1000–1700 Hz
Type A	96 dB(A)	2850 Hz	Rapid Type A	95 dB(A)	800–970 Hz
Type A	95 dB(A)	500 Hz	Slow Type A	95 dB(A)	800–970 Hz
Type A	92 dB(A)	300 Hz	Rapid Type B	97 dB(A)	2400–2850 Hz
2-tone			Slow Type B	99 dB(A)	2400–2850 Hz
Normal	97 dB(A)	600/700 Hz	Intermittent	95 dB(A)	500–1200 Hz
Rapid	94 dB(A)	800/970 Hz	Falling	94 dB(A)	1200–500 Hz
Type A	97 dB(A)	2400/2850 Hz	Buzzer	96 dB(A)	800–970 Hz
Type B	96 dB(A)	800/970 Hz	Buzzer	97 dB(A)	2400–2850 Hz
Type C	94 dB(A)	440/550 Hz	Evacuation		
Type D	96 dB(A)	600/700 Hz	Type A	94 dB(A)	440/560 Hz
with pause	96 dB(A)	600/700 Hz	Intermittent		
with pause	99 dB(A)	1200/1700 Hz	Slow intermittent A	95 dB(A)	970 Hz
with pause	100 dB(A)	2400/2850 Hz	Slow intermittent A	93 dB(A)	660 Hz
Modulating			Rapid intermittent B	97 dB(A)	2850 Hz
Type A	99 dB(A)	1000–1700 Hz	Rapid intermittent B	96 dB(A)	2850 Hz
Type B	99 dB(A)	1400–1600 Hz	Type C	95 dB(A)	970 Hz
			Type D	91 dB(A)	660 Hz
			Type E	93 dB(A)	660 Hz

System T-Mini

General features



Compact, modular warning posts with innovative, long-life LED technology and high light intensity for a variety of applications indoors and outdoors

Product features

- Optimum warning effect due to super-bright LEDs with even, all-round visibility (360°) and reliable sounders
- High failure safety even in harsh industrial environments
- Maintenance-free
- Low power consumption and low heat generation
- Lenses and housing made from impact-resistant polycarbonate PC, FR4 circuit board
- Flashing light or warning light function that can be adjusted with a switch inside each individual module
- Housing colour black

Installation

- Incl. bayonet closure with special interlocking teeth to prevent vibration
- Maximum safety thanks to contact protection (even when modules are replaced)

System T-Mini

Mounting parts



Product features

- The basic unit can be screwed onto horizontal surfaces using the supplied base or combined with KSZ...

mounting accessories

- Material/colour: impact-resistant polycarbonate, black

Model	Order no.	Description
for 24 V AC/DC		
MSZ 8610	38610	Basic unit • Incl. base, cover and all required seals for degree of protection IP65 • The bottom unit of a stacking beacon • Incl. 6-way terminal for max. 1.5 mm ² • Weight 0.1 kg
KSZ 8603	38603	Extension tube • 100 mm extension • Incl. O ring for degree of protection IP65 • Diameter 25 mm • Weight 0.03 kg
KSZ 8604	38604	Mounting bracket • For vertical mounting/wall mounting • Incl. O ring for degree of protection IP65 • 1 connection • Weight 0.04 kg
KSZ 8605	38605	Mounting bracket • For vertical mounting/wall mounting • Incl. O ring for degree of protection IP65 • 2 connections • Weight 0.04 kg

System T-Mini

Sounder module



Product features

- 1 non-adjustable tone sequence (alternating frequency 800/1000 Hz)
- Reliable tone generation due to magneto-dynamic loudspeaker
- The top unit of a stacking beacon (1 sounder per beacon possible)
- Duration of acoustic signals as long as voltage applied (use an additional relay if required)

Technical data

- For voltages see ordering overview
- Max. 77 dB(A)
- Duty cycle 100%
- Degree of protection IP54, protection class II
- -30 °C to +50 °C
- Diameter 48 mm x 61 mm
- Weight 0.18 kg

Model	Order no.	Description
MSG 8620	38620	Sounder • 24 V AC/DC (130 mA)
MSG 8630	38630	Sounder • 240 V AC (15 mA)

Warning/flashing lights

System T-Mini

Technical data

- For voltages see ordering overview
- Flash frequency approx. 110/min +/- 20.
- Duty cycle 100%
- Degree of protection IP65, protection class II

- -30°C to +50°C
- Lens diameter 48 mm, height of each module when installed 48 mm
- Weight of each lens module approx. 0.05 kg

Model	Order no.	Description
<i>for 24 V AC/DC</i>		
MWB 8621	38621	LED warning/flashing light • Yellow-orange • 3 Cd(p) • 24 V AC/DC (30 mA)
MWB 8622	38622	LED warning/flashing light • Red • 1 Cd(p) • 24 V AC/DC (30 mA)
MWB 8624	38624	LED warning/flashing light • White • 3 Cd(p) • 24 V AC/DC (30 mA)
MWB 8625	38625	LED warning/flashing light • Blue • 1 Cd(p) • 24 V AC/DC (30 mA)
MWB 8626	38626	LED warning/flashing light • Green • 1 Cd(p) • 24 V AC/DC (30 mA)
<i>for 240 V AC</i>		
MWB 8631	38631	LED warning/flashing light • Yellow-orange • - 3 Cd(p) • 240 V AC (55 mA)
MWB 8632	38632	LED warning/flashing light • Red • 1 Cd(p) • 240 V AC (55 mA)
MWB 8634	38634	LED warning/flashing light • White • 3 Cd(p) • 240 V AC (55 mA)
MWB 8635	38635	LED warning/flashing light • Blue • 1 Cd(p) • 240 V AC (55 mA)
MWB 8636	38636	LED warning/flashing light • Green • 1 Cd(p) • 240 V AC (55 mA)



Small warning/flashing beacons

Mounting parts

Product features

- For mounting on horizontal or vertical surfaces
- Incl. O ring for degree of protection IP65
- Material: Plastic PA 66

Note

- The adapter base KSZ 8002 is needed if you wish to combine the beacon with the KSZ 8001/3/4/5 accessories!

Installation

- Mounting base with 4 fixing holes for a strong hold and base seal



Model	Order no.	Description
KSZ 8002	38002	Adapter base • Is screwed directly to beacon to enable combination with the remaining accessories • Female thread • Weight 0.01 kg
KSZ 8001	38001	Mounting base • For horizontal mounting • Male thread • Weight 0.03 kg
KSZ 8003	38003	Extension tube • 100 mm extension • Diameter 25 mm • Weight 0.03 kg
KSZ 8004	38004	Mounting bracket • For vertical mounting (wall mounting) • 1 connection • Weight 0.04 kg
KSZ 8005	38005	Mounting bracket • Vertical mounting • 2 connections • Weight 0.05 kg

Small warning beacon KWL



Product features

- Good warning effect with even, all-round visibility (360°)
- Accepts 12 to 240 V (5 W or 10 W) filament bulbs + LED
- Lens in impact-resistant polycarbonate PC and PA housing (self-extinguishing)
- The beacon can be screwed directly onto horizontal surfaces or combined with mounting accessories (see above)
- Special interlocking teeth counter vibration
- Terminals for max. 1.5 mm²

Technical data

- Max. 240 V AC/DC (5 W)
- Socket: Ba15d
- Duty cycle 100%
- Degree of protection IP65, protection class II
- -30°C to +50°C
- Diameter 76 mm x 86 mm
- Weight 0.15 kg

Note

- Please order filament bulbs and LED lights separately!

Model	Order no.	Description
KWL 8101	38101	Warning light • Orange • 3 Cd(p)
KWL 8102	38102	Warning light • Red • 1–2 Cd(p)
KWL 8106	38106	Warning light • Green • 1 Cd(p)

Small LED flashing beacon KBZ for 12/24 V AC/DC



Product features

- Good warning effect with even, all-round visibility (360°)
- Integrated super bright SMD LEDs
- Highest reliability
- Functions: Permanent light, simple double (xenon effect) or triple strobe adjustable using the DIP switch
- Maintenance-free, low power consumption
- Lens in impact-resistant polycarbonate PC and PA housing (self-extinguishing)
- The beacon can be screwed directly onto horizontal surfaces or combined with mounting accessories (see above)

- Special interlocking teeth counter vibration
- Terminals for max. 1.5 mm²

Technical data

- 12/24 V AC/DC (0,09A)
- Duty cycle 100%
- Blink frequency approx. 150/min
- Degree of protection IP65, protection class II
- -30°C to +60°C
- Diameter 75 x 79 mm
- Weight 0.1 kg

Model	Order no.	Description
KBZ 8211	38211	LED-multistrobe lamp • Orange • 20 Cd(p)
KBZ 8212	38212	LED-multistrobe lamp • Red • 8 Cd(p)

Small LED flashing beacon KBZ for 90–240 V AC



Product features

- Good warning effect with even, all-round visibility (360°)
- Lens in impact-resistant polycarbonate PC and PA housing (self-extinguishing)
- The beacon can be screwed directly onto horizontal surfaces or combined with mounting accessories (see above)
- Special interlocking teeth counter vibration
- Terminals for max. 1.5 mm²

Technical data

- 90–240 V AC (0,02 A)
- Duty cycle 100 %
- Degree of protection IP65, protection class II
- -30°C to +50°C
- Diameter 76 mm x 86 mm
- Weight 0.15 kg

Model	Order no.	Description
KBZ 8221	38221	LED-multistrobe lamp • Orange • 20 Cd(p)
KBZ 8222	38222	LED-multistrobe lamp • Red • 8 Cd(p)

Middle LED flashing beacon KBZ

Product features

- Integrated super bright SMD LEDs
- Highest reliability
- Functions: Permanent light, simple double (xenon effect) or triple strobe adjustable using the DIP switch
- Maintenance-free, low power consumption

Technical data

- Duty cycle 100%
- Degree of protection IP54, protection class II
- -30°C to +60°C
- Diameter 96 mm x 83 mm
- Weight 0.1 kg



Typ	Best.-Nr.	Beschreibung
MBZ 8411	38411	LED-multistrobe lamp • Orange • 22 Cd(p) • 12/24 V AC/DC (0.32 A)
MBZ 8412	38412	LED-multistrobe lamps • Red • 13 Cd(p) • 12/24 V AC/DC (0.32 A)

Middle LED flashing beacon KBZ

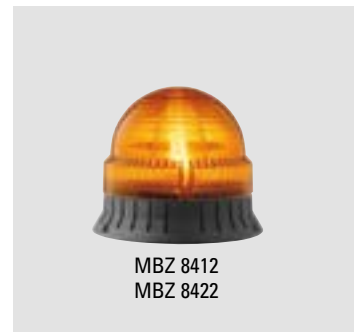

Typ	Best.-Nr.	Beschreibung
MBZ 8421	38421	LED-multistrobe lamps • Orange • 22 Cd(p) • 90-240 V AC (0.075 A)
MBZ 8422	38422	LED-multistrobe lamps • Red • 13 Cd(p) • 90-240 V AC (0.075 A)

Large warning beacon GWL

Product features

- Good warning effect with even, all-round visibility (360°)
- Accepts 12 to 240 V (25 W max.) filament bulbs) + LED
- Rugged black plastic housing made from PA (self-extinguishing) and lens in impact-resistant polycarbonate PC
- The beacon can be screwed directly onto horizontal surfaces or combined with mounting accessories (see above)
- Incl. base seal
- Terminals for max. 1.5 mm²

Technical data

- Max. 240 V AC/DC (25W)
- Socket: Ba15d
- Duty cycle 100%
- Degree of protection IP 54, protection class II
- -30°C to +50°C
- Diameter 138 mm x 115 mm
- Weight 0.3 kg

Note

- Please order filament bulbs and LED lights separately!



Model	Order no.	Description
GWL 8511	38511	Warning light • Orange • 56 Cd(p)
GWL 8512	38512	Warning light • Red • 24 Cd(p)
GWL 8516	38516	Warning light • Green • 10 Cd(p)

Large flashing beacon GBZ



High-performance xenon flashing beacon with good signal effect

Product features

- High warning effect thanks to xenon flash tube (included in scope of delivery)
- High failure safety as there are no moved parts
- Field of application: industrial hazard areas/alarm systems
- Rugged black plastic housing made from PA (self-extinguishing) and lens in impact-resistant polycarbonate PC
- The beacon can be screwed directly onto horizontal surfaces or combined with mounting accessories (see above)
- Incl. base seal
- Terminals for max. 1.5 mm²

Technical data

- For voltages see ordering overview
- Duty cycle 100%
- Replaceable xenon tube 6J
- Flash frequency: 65 flashes/min.
- Degree of protection IP54, protection class II
- -10°C to +40°C
- Diameter 138 x 115 mm
- Weight 0.38 kg

Model	Order no.	Description
GBZ 8601	38531	Flashing light • Orange • 3360 Cd(p) • 12/24 V AC/DC (1.8/0.85 A)
GBZ 8602	38532	Flashing light • Red • 1440 Cd(p) • 12/24 V AC/DC (1.8/0.85 A)
GBZ 8611	38551	Flashing light • Orange • 3360 Cd(p) • 240 V AC (0.1 A)
GBZ 8612	38552	Flashing light • Red • 1440 Cd(p) • 240 V AC (0.1 A)

Large flashing beacon GBZ - Ø 138 mm



Product features

- High warning effect thanks to xenon- flash tube (included)
- Field of application: industrial hazard areas/alarm systems
- excellent light distribution by special optics
- High failure safety as there are no moved parts
- M16 screw fitting

Technical data

- 240 V AC (0.9A)
- Replaceable xenon tube 6J
- Flash frequency: 85/min.
- Degree of protection IP54, protection class II
- -30°C to +40°C
- Diameter 130 x 138.5mm

Model	Order no.	Description
GBZ 8621	38553	Flashing light • Orange • 2650 Cd(p)
GBZ 8622	38554	Flashing light • Red • 2650 Cd(p)

Combi flashing light HBZ 85XX

A heavy-duty xenon flashing beacon with built-in sounder

Product features

- High warning effect via xenon flashtube (included in scope of delivery)
- High failure safety of the opt. signalling device as there are no moved parts
- Field of application: industrial hazard areas/alarm systems
- Incl. piezo sounder (sounds at the same time as the flash)
- Duration of optical/acoustic signals as long as voltage applied (use an additional relay if required)
- Rugged black plastic housing made from PA (self-extinguishing) and lens in impact-resistant polycarbonate PC
- The beacon can be screwed directly onto horizontal surfaces or combined with mounting accessories (see above)
- Incl. base seal
- Terminals for max. 1.5 mm²

Technical data

- For voltages see ordering overview
- Duty cycle 100%
- Replaceable xenon tube 6J
- Flash frequency: 65 flashes/min.
- Degree of protection IP 30, protection class II
- -10°C to +40°C
- Diameter 138 x 115 mm
- Weight 0.4 kg

Model	Order no.	Description
HBZ 8541	38541	Combi flashing light • Orange • 24 V DC (0.85 A) • 80 dB(A)
HBZ 8542	38542	Combi flashing light • Red • 24 V DC (0.85 A) • 80 dB(A)
HBZ 8571	38571	Combi flashing light • Orange • 240 V AC (0.1 A) • 72 dB(A)
HBZ 8572	38572	Combi flashing light • Red • 240 V AC (0.1 A) • 72 dB(A)



Rotating mirror beacon DSL (12/24 V / halogen)

Product features

- Maximum light yield through the use of halogen H1 lamps (not included in scope of delivery)
- Field of application: with homologation for industrial hazard areas/alarm systems
- Housing made from glass-fibre reinforced polyamide PA; lens made from impact-resistant PMMA
- Ball-bearing mounted reflector made from corrosion-resistant metal
- Durable toothed gear drive, sealed for life/installation
- Can be mounted on horizontal surfaces or on vertical surfaces using accessory kit DSZ 7395 (wall mounting) or with cage guard or push-fit flange

Technical data

- 12/24 V AC/DC (4.8 / 3.1 A)
- Duty cycle 100%
- Flash rate: 160/min.
- Degree of protection IP 55, protection class II
- Temperature range -30 °C to +50 °C
- Diameter 145 x 193
- Weight 0.6 kg
- Terminals for max. 1.5 mm²

Model	Order no.	Description
DSL 7302	37302	Rotating mirror beacon • Red • 10,000 Cd(p)
DSL 7307	37307	Rotating mirror beacon • Orange • 10,000 Cd(p)



Rotating mirror beacon DSL (240 V halogen)



DSL 7322



DSL 7327

Product features

- Maximum light yield through the use of halogen H1 lamps (included in scope of delivery)
- Field of application: with homologation for industrial hazard areas/alarm systems
- Housing made from glass-fibre reinforced polyamide PA; lens made from impact-resistant PMMA
- Ball-bearing mounted reflector made from corrosion-resistant metal
- Durable toothed gear drive, sealed for life Installation
- Can be mounted on horizontal surfaces or on vertical surfaces using accessory kit DSZ 7395 (wall mounting)

Technical data

- 240 V AC (0.22A)
- Duty cycle 100%
- Flash rate: 160/min.
- Degree of protection IP55, protection class II
- -30°C to +50°C
- Diameter 152 x 209
- Weight 1.5 kg
- Terminals for max. 1.5 mm²

Model	Order no.	Description
DSL 7322	37322	Rotating mirror beacon • Red • 10,000 Cd(p)
DSL 7327	37327	Rotating mirror beacon • Orange • 10,000 Cd(p)

Rotating mirror beacon DSL (standard)



DSL 73X1



DSL 73X2

Product features

- Good light yield using standard commercial bulbs (included in scope of delivery)
- Field of application: industrial hazard areas/alarm systems
- Body made from glass-fibre reinforced polyamide PA; lens made from impact-resistant polycarbonate PC
- Durable toothed gear drive, sealed for life Installation
- Can be mounted on horizontal surfaces or on vertical surfaces using accessory kit DSZ 7395 (wall mounting)

Technical data

- Flash rate: 160/min.
- Protection rating IP55, protection class II
- -30°C to +50°C
- Diameter 152 mm x 209 mm
- Terminals for max. 1.5 mm²
- Bulb 25 W (Ba15d socket)

Model	Order no.	Description
for 24 V AC		
DSL 7362	37362	Rotating mirror beacon • Red • Weight: 0.82 kg • 24 V AC (1.1 A)
DSL 7361	37361	Rotating mirror beacon • Orange • Weight: 0.82 kg • 24 V AC (1.1 A)
for 240 V AC		
DSL 7332	37332	Rotating mirror beacon • Red • Weight: 0.92 kg • 240 V AC (0.11 A)
DSL 7337	37337	Rotating mirror beacon • Orange • Weight: 0.92 kg • 240 V AC (0.11 A)

Xenon rotating beacon



Product features

- Optimum warning effect is produced by a powerful xenon flash tube (included in scope of delivery)
- The special optical system creates excellent light distribution, including upwards and downwards
- High failure safety as there are no moved parts
- Field of application: industrial hazard areas/alarm systems
- Housing made from glass-fibre reinforced polyamide PA; lens made from impact-resistant polycarbonate PC
- Terminals for max. 1.5 mm²
- Can be mounted on horizontal surfaces or on vertical surfaces using accessory kit DSZ 7395 (wall mounting)

Technical data

- 240 V AC (0.1 A)
- Replaceable xenon tube 6J
- Flash frequency: 65 flashes/min.
- Protection rating IP55, protection class II
- -30°C to +40°C
- Diameter 152 mm x 209 mm
- Weight 0.79 kg
- Terminals for max. 1.5 mm²

Model	Order no.	Description
BLZ-R 7352	37352	Xenon rotating beacon • Red
BLZ-R 7357	37357	Xenon rotating beacon • Orange

Mounting parts / accessories for DSL



Model	Order no.	Description
Accessories/spare parts		
DSZ 7395	37395	Wall bracket • Vertical mounting (wall) • Grey • Rugged plastic construction • Weight 0.2 kg
DSZ 7391	37391	Push-fit flange • Rugged plastic construction • DIN-compliant (Base A) • Black • Tube diameter 24 mm • Incl. connection leads • Weight 0.1 kg
DSZ 7394	37394	Basket protector • Stainless steel • Weight 0.27 kg

Colour-intensive LED light with high light intensity and standard commercial Ba15d base for a variety of uses in industry and commerce

Product features

- Optimum warning effect through 4 super-bright LEDs that achieve an even, all-round visibility (360°) in combination with suitable light optics
- Extremely high failure safety even in harsh industrial environments (vibration resistance in accordance with DIN 40046), with cyclical operation (constant ON/OFF switching) and voltage fluctuations of up to 20%
- Maintenance-free, service life approx. min. 100,000 hours (compared to only approx. 2000 hours with traditional bulbs)
- Low power consumption and low heat generation (max. 30°C at 230 V AC continuous power)

Installation

- Any mounting position possible due to the low heat generation
- LED lights can be used in all of the lights of the following series: SystemT (TWL, TBL), KWL, GWL. With the lights in the KWL and GWL Series, the fact that the light only radiates horizontally must be taken into account. Of course, they can also be used with the Ba15d base in the standard commercial lights of other suppliers

Technical data

- See ordering overview

Note

- Please always order the LED light in the same colour as the optical system of the corresponding light
- The LED light KSZ-LED 86X1 (yellow-orange) is suitable for use in both yellow and orange lights

Model	Order no.	Description		
<i>for 24 V AC/DC</i>				
KSZ-LED 8661	38661	LED light	Yellow-orange	24V AC/DC (45mA)
KSZ-LED 8662	38662	LED light	Red	24V AC/DC (45mA)
KSZ-LED 8664	38664	LED light	White	24V AC/DC (50mA)
KSZ-LED 8665	38665	LED light	Blue	24V AC/DC (65mA)
KSZ-LED 8666	38666	LED light	Green	24V AC/DC (45mA)
<i>for 240 V AC</i>				
KSZ-LED 8651	38651	LED light	Yellow-orange	230–240V AC (50mA)
KSZ-LED 8652	38652	LED light	Red	230–240V AC (50mA)
KSZ-LED 8654	38654	LED light	White	230–240V AC (55mA)
KSZ-LED 8655	38655	LED light	Blue	230–240V AC (70mA)
KSZ-LED 8656	38656	LED light	Green	230–240V AC (50mA)

Note: Please order the LED-lamps always in the same colour as the optics of the respective light. The LED-lamp of the KSZ-LED 86X1 (yellow/orange) is suitable for both the yellow and the orange lights. The intensity of the LED-lamp "KSZ-LEDxxxx" when fitted is consistent with the stated light intensity of the light modules.

Bulbs for Ba15d socket

Model	Order no.	Description	
DSZ 7396	37396	Bulb • 24V (25W)	• for DSL 7361 and 7362
DSZ 7397	37397	Bulb • 240V (25W)	• for DSL 7332 and 7337
GSZ 8591	38591	Bulb • 12V (25W)	• for GWL 85xx
GSZ 8592	38592	Bulb • 24V (25W)	• for GWL 85xx
GSZ 8593	38593	Bulb • 240V (25W)	• for GWL 85xx
KSZ 8595	38595	Bulb • 12V (5W)	• for TWL 871x, TBL 87xx and KWL 810x
KSZ 8596	38596	Bulb • 24V (5W)	• for TWL 871x, TBL 87xx and KWL 810x
KSZ 8597	38597	Bulb • 240V (5W)	• for TWL 871x, TBL 87xx and KWL 810x

Model	Order no.	Description	
<i>Accessories/spare parts</i>			
DSZ 7381	37381	Halogen lamp • H1	• 12 V (55 W) • Weight 0.01 kg
DSZ 7382	37382	Halogen lamp • H1	• 24 V (70 W) • Weight 0.01 kg
DSZ 7383	37383	Xenon light	• 6 J



Motion Sensors

»If you're afraid of secret visitors ...«



Motion Sensors

The new McGuard generation offers you many benefits including easy installation, convenient use and reliability in everyday use.

McGuard - the professional development for energy management, convenience and security. Movement detectors can be used to individually control light, heating, air conditioning and alarm systems, according to your specifications and requirements. Resources are spared and a pleasant and secure environment is created.

McGUARD Series



- McGuard motion sensor
- McGuard mini
- McGuard professional
- McGuard Halo
- McGuard LED floodlight

The McGuard family now consists of over 10 different models with each being customised in its own area and functionally compatible with other in the series.

Grothe reliability is combined in every unit making them easy to install and use on a daily basis.

LED floodlight
McGuard PIR BM LED light



Power consumption: 16 W
Average life expectancy 30,000 h
Colour temperature: neutral
Total luminous flux: 1200 lm

Spotlight rotates horizontally and swivels vertically

Power Consumption: 31 W
Average life expectancy 30,000 h
Colour temperature: neutral
Alternative to 300 W halogen
Total luminous flux: 2200 lm



McGuard motion sensor



PIR (passive infrared) movement detector
Surveillance range 360° at an installation height of 6 m
Surface mounted

Light intensity adjustable from 5–1000 lux
Timer adjustable from 3 sec. to 15 min.
Surveillance range adjustable from 6–12 m
Surveillance angle: 240°
Total luminous flux: 2200 lm

McGuard Halogen floodlight



Die-cast aluminium housing
Floodlight can be swivelled horizontally and vertically

IR movement detector

McGuard

Professional

Model	Order no.	Description
BM120ws	94530	McGuard professional BM120ws <ul style="list-style-type: none"> • Passive infrared movement detector • Colour: white • Ceiling, wall and corner installation (incl. universal angle) • Surveillance range 120° at 12m • Crawl under protection radius 1m • On time from 3 sec. to 12 min. • Low charge suitability • Switching capacity: Bulbs max. 1000W • Energy saving lamps max. 250W • Fluorescent lamps max. 250W • LED Lamps max. 200W • IP55 (suitable for outdoor area) • 84(B) x 78(H) x 120(D)mm • Power supply: 230 V AC; 50Hz • Sensitivity continuously adjustable
BM240ws	94531	McGuard professional BM240ws <ul style="list-style-type: none"> • like McGuard professional BM120ws, but surveillance range 240°
BM360ws	94532	McGuard professional BM360ws <ul style="list-style-type: none"> • like McGuard professional BM120ws, but surveillance range 360°
BM120sw	94533	McGuard professional BM120sw <ul style="list-style-type: none"> • Passive infrared movement detector • Colour: black • Ceiling, wall and corner installation (incl. universal angle) • Surveillance range 120° at 12 m • Crawl under protection radius 1m • On time from 3 sec. to 12 min. • Low charge suitability • Switching capacity: Bulbs max. 1000W; • Energy saving lamps max. 250W • Fluorescent lamps max. 250W • LED Lamps max. 200W • IP55 (suitable for outdoor area) • 84(B) x 78(H) x 120(D)mm • Power supply: 230 V AC; 50 Hz • Sensitivity continuously adjustable
BM240sw	94534	McGuard professional BM240sw <ul style="list-style-type: none"> • like McGuard professional BM120sw, but surveillance range 240°
BM360sw	94535	McGuard professional BM360sw <ul style="list-style-type: none"> • like McGuard professional BM120sw, but surveillance range 360°



Professional remote control

Model	Order no.	Description
BM240iws	94536	McGuard professional BM240iws <ul style="list-style-type: none"> • as McGuard professional BM240ws, with receiver for remote control McGuard IR FB (Art. 94538, to be ordered separately) • On time from 3 sec. to 15 min. • effective power: 1,1W
BM360iws	94537	McGuard professional BM360iws <ul style="list-style-type: none"> • as McGuard professional BM360ws, with receiver for remote control McGuard IR FB (Art. 94538, to be ordered separately) • On time from 3 sec. to 15 min. • effective power: 1,1W
IR FB	94538	McGuard Infrared Remote <ul style="list-style-type: none"> • for the motion sensors McGuard BM240iws and BM360iws • Range: ca. 6m • Colour: anthracite • Power supply: Battery CR 2025, 3V • 55 x 90 x 7 mm
MISTRAL BM03	43445	Radio movement detector <ul style="list-style-type: none"> • incl. lithium battery 3V type CR123A or 8-12V≈/- • For all MISTRAL, ECHO and CALIMA doorbells (since 2003) • Max. surveillance range: 108° at 15m opt. range • Walking test with LED display • Colour: White plastic • 69(B) x 124(H) x 54(D)mm • 500 m radio range outdoors; 868.35MH • Adjustable delay time from 3 to 60 sec • Incl. curtain lens and volumetric lens

McGuard

Motion Sensors

Model	Order No.	Description
PM-APws	94500	<p>McGuard PM-APws</p> <ul style="list-style-type: none"> • Passive Infrared Motion Sensor • Colour: White • Surveillance Area: 360° at 6m • Activation time 5 secs to 12 mins • Fluorescent lamps max. 400 W • Infinitely variable response sensitivity • HV-Halogen Lamp max. 1000 W • Degree of protection IP40 <ul style="list-style-type: none"> • 2 Outputs 1x non-isolated 1 x isolated • Switch Capacity: Lightbulb max. 2300 W • 113 () x 39 mm • Operating Temperature: - 10 to + 45°C • Power supply: 230 V AC; 50 Hz • Active Power: 1,6 W • Low Charge Suitability
PM-EINws	94501	<p>McGuard PM-EINBws</p> <ul style="list-style-type: none"> • Passive Infrared Motion Sensor • Colour: White • Incl. Control Box • Surveillance Area 360° at 6m • HV Halogen Lamp max. 1000 W • Activation time 5 secs to 12 mins • Fluorescent lamps max. 400 W • Infinitely variable response sensitivity • Degree of protection IP40 <ul style="list-style-type: none"> • 2 Outputs 1x non-isolated 1 x isolated • Switch Capacity: Lightbulb max. 2300 W • Motion Sensor: 78 (0) x 50 mm • Installation Depth: 40 mm • Control Box: 110 x 53 x 30 mm • Operating Temperature: - 10 to + 45°C • Power supply: 230 V AC; 50 Hz • Active Power: 1,3 W • Low Charge Suitability
PM-APws	94503	<p>McGuard PM-AP HR</p> <ul style="list-style-type: none"> • Passive Infrared Motion Sensor • Mounting Assembly • Colour: White • Surveillance Area 360° to 16 m diameter at assembly mount height of 10 Meter • Activation time 5 secs to 30 mins • Infinitely variable response sensitivity • Degree of protection IP44 <ul style="list-style-type: none"> • Switch Capacity: • Light Bulb max. 2000 W • HV - Halogen Lamp max. 1000 VA • NV Halogen max. 1000 VA • Fluorescent lamps 1000 VA/600 W uncompensated • LED Lamp max. 400 W • Energy saving bulbs: max. 600 VA/400W • Operating Temperature: - 0 to + 45°C • Dimensions: (0) 115 x 50 mm • Power supply: 230 V AC; 50 Hz • Low Charge Suitability
BM-DAV	94504	<p>McGuard BM-DAV</p> <ul style="list-style-type: none"> • Passive Infrared Motion Sensor • Mounting Assembly • Colour: White • Surveillance Area 360° to 7 m diameter at assembly mount height of 2,5 Meter • Activation time 5 secs to 20 mins • Infinitely variable response sensitivity • Degree of protection IP44 • Adjustable Sound Post-triggering: OFF, 45 dB to 70 dB <ul style="list-style-type: none"> • Switch Capacity: • Light Bulb max. 1000 W • Fluorescent lamps 500 VA • LED Lamp max. 250 W • Energy saving bulbs: max. 500 W • Operating Temperature: - 0 to + 45°C • Dimensions: (0) 120 x 25 mm • Power supply: 220-240 V AC; 50 Hz • Low Charge Suitability
BM-DE-PB	94506	<p>McGuard BM-DE-PB</p> <ul style="list-style-type: none"> • Passive Infrared Motion Sensor • Mounting Assembly • Colour: White • Surveillance Area 360° to 8 m diameter at assembly mount height of 2,5 Meter • Activation time 30 secs to 30 mins • Infinitely variable response sensitivity • Degree of protection IP40 <ul style="list-style-type: none"> • Switch Capacity: Light Bulb max. 21000 W • HV_Halogen Lamps max. 1000 W • Fluorescent lamps 500 VA • LED Lamp max. 500 W • Energy saving bulbs: max. 500 W • Operating Temperature: - 0 to + 45°C • Dimensions: • Diameter: 50 mm • Drill hole: 38 mm • Installation Depth: 55 mm • Power Box: 130 x 25 x 28 mm • Power supply: 220-240 V AC; 50 Hz • Low Charge Suitability



PM-APws



PM-EINBws



PM APws



BM-DAV



BM-DE-PB

McGuard

Motion Sensor



BM-DEBws



IR-11



BM-UPws



BM-HF-EBws

Model	Order No.	Description
BM-DEB	94505	<p>McGuard BM-DAV</p> <ul style="list-style-type: none"> • Passive Infrared Motion Sensor • Assembly Mount • Colour: White • Surveillance Area 360° to 20 m diameter at assembly mount height of 2,5 Meter • Activation time 1 (Light): 5 secs to 30 mins • Activation time 2 (Air-conditioning control): 10 secs to 60 mins • Infinitely variable response sensitivity • Degree of protection IP44 <ul style="list-style-type: none"> • Switch Capacity: • Charge 1 (Light) Bulbs max. 2000 W • HV-Halogen Lamps: max. 1000 W • NV-Halogen Lamps: max. 1000 VA / 600 W (magnetic) max. 1000 VA / 900 W (electric) • Fluorescent lamps 1000 VA/600 W (uncompensated) <ul style="list-style-type: none"> • 25x (1 x 18 W); 12x (2 x 18 W) • 15x (1 x 36 W); 7x (2 x 36 W) • 10x (1 x 58 W); 5x (2 x 58 W) • LED Lamp max. 500 VA 7 400 W • Energy saving bulbs: max.600 VA/400W • Switch Capacity Charge 2 (Air-conditioning control): <ul style="list-style-type: none"> • Max. 5 A (cos phi01) for ≤ 250 V AC • Operating Temperature: - 0 to + 45°C • Dimensions: Diameter: 82 mm • Drill hole: 65 mm • Installation Depth: 62 mm • Power supply: 230 V 50 Hz • Low Charge Suitability
IR-11	94508	<p>McGuard IR-11</p> <ul style="list-style-type: none"> • Infrared remote control • Suitable for Motion Sensor BM-DEB • Operating Area: 10 m • Colour: Anthracite <ul style="list-style-type: none"> • Incl. Wall brackets/Mount • Power Supply: Battery CR 2032
BM-UP	94522	<p>McGuard BM-UP</p> <ul style="list-style-type: none"> • Passive Infrared Motion Sensor • Switch Socket Assembly Mount • Colour: White • Surveillance Area 180° to 8 m frontal view / 6 m lateral view at assembly mount height of 1,2 Meter • Activation time 10 secs to 30 mins • Adjustable Sound Post-triggering • Infinitely variable response sensitivity • Degree of protection IP40 <ul style="list-style-type: none"> • Switch Capacity: • Light Bulbs max. 1000 W • HV-Halogen Lamps: max. 200 VA • NV-Halogen Lamps: max. 200 W • Fluorescent lamps max: 150 VA W <ul style="list-style-type: none"> • 25x (1 x 18 W); 12x (2 x 18 W) • 15x (1 x 36 W); 7x (2 x 36 W) • 10x (1 x 58 W); 5x (2 x 58 W) • LED Lamp max. 150 W (Uncompensated) • Energy saving bulbs: max. 600 VA/400 W • Operating Temperature: - 0 to + 45°C • Dimensions: 90 x 51 31 mm • Power supply: 230 V AC ± 10%; 50 Hz / 60 Hz • Low Charge Suitability
BM-HF-EB	94520	<p>McGuard BM-HF-EB</p> <ul style="list-style-type: none"> • HF Motion Sensor • Easy Installation • Colour: White • Surveillance Area 360° to 10 m at assembly mount height of 2.5 Meter • Activation time 10 secs to 30 mins • Infinitely variable response sensitivity • Frequency; 5.8 GHz • Degree of protection IP40 <ul style="list-style-type: none"> • Switch Capacity: • Light Bulbs max. 1000 W • HV-Halogen Lamps: max. 200 VA • NV-Halogen Lamps: max. 200 W • Fluorescent lamps max: 150 VA W <ul style="list-style-type: none"> • 25x (1 x 18 W); 12x (2 x 18 W) • 15x (1 x 36 W); 7x (2 x 36 W) • 10x (1 x 58 W); 5x (2 x 58 W) • LED Lamp max. 150 W (Uncompensated) • Energy saving bulbs: max. 600 VA/400W • Operating Temperature: - 0 to + 45°C • Dimensions: 90 x 51 31 mm • Power supply: 230 V AC ±10%; 50 Hz / 60 Hz • Low Charge Suitability

McGuard



LED RL300Aws





LED RL692JVws



Mc-Guard Mantis

LED-floodlight spots

Model	Order no.	Description
LED RL692JH ws 	94555	McGuard LED floodlight <ul style="list-style-type: none"> • LED Floodlight/Infrared Motion Sensor • 2 Integrated High Power LEDs • Illumination Angle: 90° • Alu Casing / V2A screws • Vertical installation • Surveillance Area: 240° at 10m <ul style="list-style-type: none"> • Colour: White • Protection: IP55 (Suitable for outdoor use) • Activation time: 3 secs to 15 mins • Infinitely variable response sensitivity • LEDS: 2200 lm • 5000° Kelvin/Daylight white • Power supply: 230 V AC, 50 Hz • Active Power; 0.8W (Standby Mode) 31 W (IR-LEDs activated) • Dimensions: 270 x 205 x 145 mm
LED RL692JV ws 	94559	McGuard LED Spotlight/IR Motion Sensor <ul style="list-style-type: none"> • LED Floodlight/Infrared Motion Sensor • 4 Integrated High Power LEDs • Illumination Angle: 90° • Alu Casing / V2A screws • Vertical installation • Surveillance Area: 240° at 10m <ul style="list-style-type: none"> • Colour: White • Protection: IP55 (Suitable for outdoor use) • Activation time: 3 secs to 15 mins • Infinitely variable response sensitivity • LEDS: 4000 lm • 5000° Kelvin/Daylight white • Power supply: 230 V AC, 50 Hz • Active Power; 0.8 W (Standby Mode) 62 W (IR-LEDs activated) • Dimensions: 340 x 205 x 150 mm
McGuard Mantis 	94560	McGuard LED Spotlight/IR Motion Sensor <ul style="list-style-type: none"> • LED Floodlight/Infrared Motion Sensor • 2 adjustable buttons incl. Integrated High Power LEDs • Illumination Angle: 90° • Synthetic Casing / V2A screws • Vertical installation • Surveillance Area: 180° at 9m <ul style="list-style-type: none"> • Colour: White • Protection: IP44 (Suitable for outdoor use) • Activation time: 10 secs to 15 mins • Infinitely variable response sensitivity • LEDS: 1200 lm • 5000° Kelvin/Daylight white • Power supply: 230 V AC, 50 Hz • Active Power; 0.8 W (Standby Mode) 16 W (IR-LEDs activated) • Dimensions: 150 x 180 x 110 mm

Transformers / Rail mounted devices

»Don't underestimate due to size«





















Transformers / Rail mounted devices

Optimum performance and all conventional voltages!

In all matters pertaining to environmental compatibility and safety GROTHE transformers are setting trends. The transformers protected by patent law are not only the core of a reliable bell system, but also, because of the high standards involved, also represent an ideal solution for the industrial sector.



- Installation in current distribution board
- Compact dimensions
- Comply with the highest environmental protection regulations

			<table border="1"> <thead> <tr> <th>Nr.</th> <th>Name</th> <th>Country</th> </tr> </thead> <tbody> <tr><td>01</td><td>AENOR</td><td>Spain</td></tr> <tr><td>02</td><td>CEBEC</td><td>Belgium</td></tr> <tr><td>03</td><td>IMQ</td><td>Italy</td></tr> <tr><td>04</td><td>IPQ</td><td>Portugal</td></tr> <tr><td> 05</td><td>KEMA</td><td>Netherlands</td></tr> <tr><td>06</td><td>NSAI</td><td>Ireland</td></tr> <tr><td>07</td><td>SEE</td><td>Luxembourg</td></tr> </tbody> </table>			Nr.	Name	Country	01	AENOR	Spain	02	CEBEC	Belgium	03	IMQ	Italy	04	IPQ	Portugal	 05	KEMA	Netherlands	06	NSAI	Ireland	07	SEE	Luxembourg																								
			Nr.	Name	Country																																																
01	AENOR	Spain																																																			
02	CEBEC	Belgium																																																			
03	IMQ	Italy																																																			
04	IPQ	Portugal																																																			
 05	KEMA	Netherlands																																																			
06	NSAI	Ireland																																																			
07	SEE	Luxembourg																																																			
Inspection stations:																																																					
<table border="1"> <thead> <tr> <th>Nr.</th> <th>Name</th> <th>Country</th> </tr> </thead> <tbody> <tr><td>08</td><td>UTE</td><td>France</td></tr> <tr><td>09</td><td>ELOT</td><td>Greece</td></tr> <tr><td> 10</td><td>VDE</td><td>Germany</td></tr> <tr><td> 11</td><td>ÖVE</td><td>Austria</td></tr> <tr><td>12</td><td>BSI</td><td>UK</td></tr> <tr><td>13</td><td>SEV</td><td>Switzerland</td></tr> <tr><td> 14</td><td>SEMKO</td><td>Sweden</td></tr> </tbody> </table>			Nr.	Name	Country	08	UTE	France	09	ELOT	Greece	 10	VDE	Germany	 11	ÖVE	Austria	12	BSI	UK	13	SEV	Switzerland	 14	SEMKO	Sweden	<table border="1"> <thead> <tr> <th>Nr.</th> <th>Name</th> <th>Country</th> </tr> </thead> <tbody> <tr><td>15</td><td>DEMKO</td><td>Denmark</td></tr> <tr><td> 16</td><td>FIMKO</td><td>Finland</td></tr> <tr><td> 17</td><td>NEMKO</td><td>Norway</td></tr> <tr><td>18</td><td>MEEI</td><td>Hungary</td></tr> <tr><td>19</td><td>BEAB</td><td>UK</td></tr> <tr><td>20</td><td>ASTA</td><td>UK</td></tr> <tr><td>21</td><td>EZU</td><td>Czech Republ.</td></tr> </tbody> </table>			Nr.	Name	Country	15	DEMKO	Denmark	 16	FIMKO	Finland	 17	NEMKO	Norway	18	MEEI	Hungary	19	BEAB	UK	20	ASTA	UK	21	EZU	Czech Republ.
Nr.	Name	Country																																																			
08	UTE	France																																																			
09	ELOT	Greece																																																			
 10	VDE	Germany																																																			
 11	ÖVE	Austria																																																			
12	BSI	UK																																																			
13	SEV	Switzerland																																																			
 14	SEMKO	Sweden																																																			
Nr.	Name	Country																																																			
15	DEMKO	Denmark																																																			
 16	FIMKO	Finland																																																			
 17	NEMKO	Norway																																																			
18	MEEI	Hungary																																																			
19	BEAB	UK																																																			
20	ASTA	UK																																																			
21	EZU	Czech Republ.																																																			

Grothe transformers “Made in Germany” bell transformers are optimised for short term use in residential applications such as doorbells, gongs, alarm bells, door openers and safety transformers in continuous use.

Grothe bell and safety transformers are protected with a PTC, which switches the transformer off on short circuit and overload on the primary side. On switching of the PTC through overload or short circuit, the transformer needs to be taken off the load for at least 1 minute in order for it to be put back into service.

All transformers comply with the highest environmental protection regulations, are checked according to EN61558 and are certified according to VDE and KEMA (with ENEC mark for use in Europe).

GROTHE Bell transformers

For short term load
 Tested according to EN 61558-2-6:2011
 Short circuit proof through PTC (except GT50810)



Surface-mounted

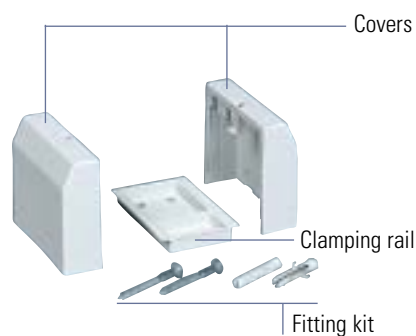

GROTHE Safety transformers

Suitable for permanent load
 Tested according to EN 61558-2-6:2010
 Short circuit proof through PTC



GROTHE Stair case light timer

Timer setting: continuously adjustable to up to 12 min.

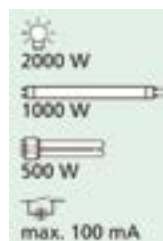

Switching capacity:

- Bulbs
- Fluorescent tubes
- Energy saving bulbs
- Low voltage neon-glow lamp

For 3 or 4 wire circuits

Switch-off advance warning according to DIN



Standard bell transformers



up to 18 VA

Model	Order no.	Description
GT 3148	14201	Bell transformer <ul style="list-style-type: none"> • Primary: 230-240V AC (50 Hz) • 8V AC (1,0A) • 90 x 36 x 55 mm (corresponds to 2 subunits)
GT 3139	14039	Bell transformer function as above, but <ul style="list-style-type: none"> • 8/12V AC (1,5/1,0A)
GT 3158	14058	Bell transformer function as above, but <ul style="list-style-type: none"> • 12V AC (1,0A)
GT 3173	14073	Bell transformer function as above, but <ul style="list-style-type: none"> • 4/8/12V AC (2,0/2,0/1,5A)
GT 3182	14082	Bell transformer function as above, but <ul style="list-style-type: none"> • 8/12/24V AC (2,0/1,3/0,6A)
GT 50810	14207	Bell transformer Fail-safe <ul style="list-style-type: none"> • in case of wrong use permanent damage possible • 8V AC (1,0A)
GT 36 AP	14936	Surface-mount installation set

up to 24 VA

Model	Order no.	Description
GT 3174	14074	Bell transformer <ul style="list-style-type: none"> • Primary: 230-240V AC (50 Hz) • 4/8/12V~ (3,0/2,0/2,0A) • 90 x 54 x 55 mm (corresponds to 3 subunits)
GT 54 AP	14954	Surface-mount installation set

with power switch

Model	Order no.	Description
GT 3148 S	14211	Bell transformer <ul style="list-style-type: none"> • Primary: 230-240V AC (50 Hz) • 8V AC (1,0A) • 90 x 36 x 55 mm (corresponds to 2 subunits)
GT 3139 S	14049	Bell transformer function as above, but <ul style="list-style-type: none"> • 8/12V AC (1,5/1,0A)
GT 3173 S	14083	Bell transformer function as above, but <ul style="list-style-type: none"> • 4/8/12V AC (2,0/2,0/1,5A)
GT 36 AP	14936	Surface-mount installation set

Safety transformers



up to 18 VA

Model	Order no.	Description
GT 1965	14102	Safety transformer <ul style="list-style-type: none"> • Primary: 230-240V AC (50 Hz) • 8V AC (2,0A) • 90 x 36 x 55 mm (corresponds to 2 subunits)
GT 1975	14101	Safety transformer function as above, but <ul style="list-style-type: none"> • 12V AC (1,5A)
GT 36 AP	14936	Surface-mount installation set

up to 25 VA

Model	Order no.	Description
GT 1973	14034	Safety transformer <ul style="list-style-type: none"> • Primary: 230-240V AC (50 Hz) • 8/12V AC (2,0/2,0A) • 90 x 54 x 55 mm (corresponds to 3 subunits)
GT 54 AP	14954	Surface-mount installation set

up to 63 VA

Model	Order no.	Description
GT 1980	14140	Safety transformer <ul style="list-style-type: none"> Primary: 230-240V AC (50 Hz) 12/16/24/32V AC (3,3/2,5/1,6/1,2A) 90 x 90 x 55 mm (corresponds to 5 subunits)
GT 1990	14160	Safety transformer function as above, but <ul style="list-style-type: none"> 12/24 V AC (5,2/2,6 A)
GT 90 AP	14990	Surface-mount installation set
NG AL12/5A	39340	Power supply unit <ul style="list-style-type: none"> Power supply unit with replaceable primary fuse Din rail use / on wall use Primary 230 V AC, 50 HZ Secondary 12 V DC, max. 5 A for CCTV cameras prim. 12 V DC Size 123 x 100 x 68 mm LED indication for mains voltage (corresponds to 2 subunits) weight: 340 g
NG AL12/2A	39342	Power supply unit <ul style="list-style-type: none"> Power supply unit with potentiometer Din rail use / on wall use Primary 100–240 V AC, 50 HZ Secondary 12 V DC, max. 2 A for CCTV-cameras prim. 12 V DC Size 94 x 36 x 69 mm LED indication for mains voltage 2 subunits weight: 135 g
NG AL24/1A	39343	Power supply unit <ul style="list-style-type: none"> Power supply unit with replaceable primary fuse Din rail use / on wall use Primary 100–240 V AC, 50 HZ Secondary 12 V DC, max. 1 A for closed circuit door opener Size 94 x 36 x 69 mm LED indication for mains voltage 2 subunits weight: 135 g



Staircase light time switch

Description

- Electronic control
- Time setting: Continuously variable up to 12 min
- 3/4-lead circuits delayed switching capacity/switching time extension (3-lead circuit for unit replacement in existing installations only)
- Installation in electrical distributor (standard rail)
- Switch-off advance warning in accordance with DIN 18015-2, 1996-08 (approx. 30 seconds before time expiry; flickers several times)
- Switch-off advance warning can be disabled
- Adjustable continuous light function on the light switch or on the staircase light time switch

Technical data

- Operating voltage (230 V AC/50 Hz)
- Contact load: 16 A, (one normally open contact)
- Control voltage: 8–230 V AC/DC and 230 V AC
- Max. load capacity: Filament bulbs 2000 W, energy-saving bulbs 1000 W, fluorescent tubes 750/1000 W (compensated/uncompensated).
- Temperature range -25°C to +55°C
- 82 x 18 x 58 mm (1 module width)
- Staircase light controlled via light switch (230 V AC):
 - Press light switch repeatedly for < 1 sec: Extension of the lighting period by set time (additive)
 - Press light switch for switch for > 1 sec: Continuous „On“/ Continuous „Off“ (Auto „Off“ after 1 hr)



Model	Order no.	Description
TA 220d	94022	Staircase light time switch

Staircase light time switch

Function overview

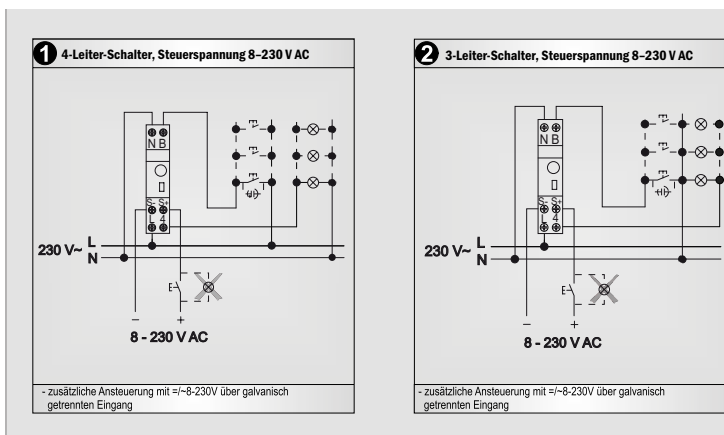

Bell buttons, Contacts and Storey plates



»We are often envied for our worldwide contacts«

Bell Buttons, Contacts and Storey plates

The visitor's card of a host company!

Add interesting features to the entrance area! The standard product range alone caters to every taste and requirement.

We can also customize bell panels to suit individual wishes.



- Innovative ringer buttons
- Attractive designs
- Flush as well as surface mounted varieties
- Maximum reliability

Protact: The innovative ring button by Grothe with its metal switching contacts and time saving wiring technology for fitting in door stations or for industrial purposes.

The ringer buttons are characterised by their optimal switching performance with tactile feedback and short bounce times and are ideal for use in bus units.

Ringer button, front plates:

Whether ringer buttons in stainless steel, brass, aluminium, bronze or weatherproof plastic, Grothe offers a multitude of design possibilities for your entrance area.

Protact



Gilded switching contacts
Tactile feedback
Through snapping effect



Fast installation - no screwing
Two connectors each for simple in-line wiring



Rubber seal for protection of the switching contacts

Ringbutton



PROTACT

1xx Series

Type	Order no.	Description	PU
PROTACT 150 VA	62000	Bell button <ul style="list-style-type: none"> • Button stainless steel V2A • Button collar stainless steel V2A • 16 mm diameter hole required 	<ul style="list-style-type: none"> • Diameter of button 14.5 mm • Diameter of button collar 22.0 mm 5
PROTACT 140 GO	62001	Bell button <ul style="list-style-type: none"> • Button gold-plated brass • Button collar gold-plated brass • 16 mm diameter hole required 	<ul style="list-style-type: none"> • Diameter of button 14.5 mm • Diameter of button collar 22.0 mm 5
PROTACT 110 AL	62002	Bell button <ul style="list-style-type: none"> • Button aluminium • Button collar aluminium • 16 mm diameter hole required 	<ul style="list-style-type: none"> • Diameter of button 14.5 mm • Diameter of button collar 22.0 mm 5

2xx Series

Type	Order no.	Description	PU
PROTACT 210 AL	62045	Bell button <ul style="list-style-type: none"> • Button aluminium • Button collar aluminium • 16 mm diameter hole required 	<ul style="list-style-type: none"> • Diameter of button button 11.5 mm • Diameter of button collar 20.0 mm 5
PROTACT 260 CR	62054	Bell button <ul style="list-style-type: none"> • Button chrome-plated brass • Button collar chrome-plated brass • 16 mm diameter hole required 	<ul style="list-style-type: none"> • Diameter of button button 11.5 mm • Diameter of button collar 20.0 mm 5

3xx Series

Type	Order no.	Description	PU
PROTACT 340 GO	62025	Bell button <ul style="list-style-type: none"> • Button gold-plated brass • Button collar gold-plated brass • 16 mm diameter hole required 	<ul style="list-style-type: none"> • Diameter of button button 11.5 mm • Diameter of button collar 20.0 mm 5
PROTACT 370 NI	62026	Bell button <ul style="list-style-type: none"> • Button nickel-plated brass • Button collar nickel-plated brass • 16 mm diameter hole required 	<ul style="list-style-type: none"> • Diameter of button button 11.5 mm • Diameter of button collar 20.0 mm 5
PROTACT 371 NI	62034	Bell button <ul style="list-style-type: none"> • Button nickel-plated brass • Button collar nickel-plated brass • 16 mm diameter hole required 	<ul style="list-style-type: none"> • Diameter of button button 11.5 mm • Diameter of button collar 20.0 mm 5
PROTACT 310 AL	62032	Bell button <ul style="list-style-type: none"> • Button aluminium • Button collar aluminium • 16 mm diameter hole required 	<ul style="list-style-type: none"> • Diameter of button button 11.5 mm • Diameter of button collar 20.0 mm 5
PROTACT 360 CR	62033	Bell button <ul style="list-style-type: none"> • Button chrome-plated brass • Button collar chrome-plated brass • 16 mm diameter hole required 	<ul style="list-style-type: none"> • Diameter of button button 11.5 mm • Diameter of button collar 20.0 mm 5



PROTACT 150 VA



PROTACT 140 GO



PROTACT 110 AL



PROTACT 210 AL

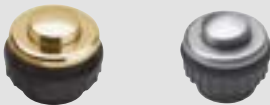

PROTACT 340 GO PROTACT 371 NI



PROTACT 370 NI PROTACT 310 AL



PROTACT 360 CR

PROTACT

4xx Series

Type	Order no.	Description	PU
PROTACT 450 VA	62006	Bell button <ul style="list-style-type: none"> • Button stainless steel V2A • Button collar stainless steel V2A • 16 mm diameter hole required 	<ul style="list-style-type: none"> • Diameter of button button 11.5 mm • Diameter of button collar 20.0 mm 5
PROTACT 420 AL-KS	62013	Bell button <ul style="list-style-type: none"> • Button black plastic • Button collar aluminium R14 • 16 mm diameter hole required 	<ul style="list-style-type: none"> • Diameter of button button 11.5 mm • Diameter of button collar 20.0 mm 5
PROTACT 410 AL	62016	Bell button <ul style="list-style-type: none"> • Button aluminium • Button collar aluminium • 16 mm diameter hole required 	<ul style="list-style-type: none"> • Diameter of button button 11.5 mm • Diameter of button collar 20.0 mm 5

5xx Series

Type	Order no.	Description	PU
PROTACT 550 VA	62060	Bell button <ul style="list-style-type: none"> • Button stainless steel V2A • Button collar stainless steel V2A • 16 mm diameter hole required 	<ul style="list-style-type: none"> • Diameter of button button 16.8 mm • Diameter of button collar 22.0 mm 5
PROTACT 510 AL	62061	Bell button <ul style="list-style-type: none"> • Button aluminium • Button collar aluminium • 16 mm diameter hole required 	<ul style="list-style-type: none"> • Diameter of button button 16.8 mm • Diameter of button collar 22.0 mm 5

38x Series

Type	Order no.	Description	PU
PROTACT 380 KS	61031	Bell button <ul style="list-style-type: none"> • Button white-grey plastic • Button collar black plastic • 16 mm diameter hole required 	<ul style="list-style-type: none"> • Diameter of button button 11.5 mm • Diameter of button collar 20.0 mm 5
PROTACT 381 KS	61032	Bell button <ul style="list-style-type: none"> • Button white-grey plastic • Button collar white-grey plastic • 16 mm diameter hole required 	<ul style="list-style-type: none"> • Diameter of button button 11.5 mm • Diameter of button collar 20.0 mm 5

68x Series

Type	Order no.	Description	PU
PROTACT 681 KS	61045	Bell button <ul style="list-style-type: none"> • Button black plastic • Button collar black plastic • 16 mm diameter hole required 	<ul style="list-style-type: none"> • Button 13.5 x 16.0 mm • Button collar 20.0 x 22.0 mm 5
PROTACT 680 KS	61047	Bell button <ul style="list-style-type: none"> • Button white-grey plastic • Button collar white-grey plastic • 16 mm diameter hole required 	<ul style="list-style-type: none"> • Button 13.5 x 16.0 mm • Button collar 20.0 x 22.0 mm 5
PROTACT 650 VA	62070	Bell button <ul style="list-style-type: none"> • Button white-grey plastic • Button collar white-grey plastic • 16 mm diameter hole required 	<ul style="list-style-type: none"> • Button 13.5 x 16.0 mm • Button collar 20.0 x 22.0 mm 5



PROTACT



with illumination

Type	Order no.	Description	PU
PROTACT 101 LED	63022	Bell button • Button red plastic • Button collar aluminium	3
PROTACT 100 LED	63032	Bell button • Button red plastic • Button collar black aluminium	3
PROTACT 102 LED	63042	Bell button • Button red plastic • Button collar gold-plated brass	3
PROTACT 105 LED	63052	Bell button • Button red plastic • Button collar stainless steel V2A	3

with illumination

Type	Order no.	Description	PU
PROTACT 210 LED	63222	Bell button • Button white plastic • Button collar aluminium	1
PROTACT 220 LED	63232	Bell button • Button blue plastic • Button collar aluminium	1
PROTACT 230 LED	63242	Bell button • Button white plastic • Button collar aluminium	1
PROTACT 240 LED	63252	Bell button • Button blue plastic • Button collar aluminium	1



Panel button KKO 2112

Description

- Plastic, rectangular
- Illumination-capable panel button
- Can be used optionally as bell button or light button

Technical data

- 21 x 70 x 17 mm
- Plate thickness 2.5 mm

- Plate punch-out 19.5 x 68 mm
- Switching capacity: Max. 24 V AC (5m A–1.5 A/24 VA)
- Switching capacity: Max. 24 V DC (5 mA–1.0 A/12 W)

Note

- Order sofit 2030 LED (order no. 51037) separately!
See chapter Access Controls & Accessories

Type	Order no.	Description	PU
KKO 2112 BR	51006	Panel button	3

Stainless steel storey plate, circular

Type	Order no.	Description
ETA S 100	55540	Storey plate <ul style="list-style-type: none"> Prestigious stainless steel housing in solid design Bell contact with a noble look; stainless steel; extremely resistant to vandalism thanks to the smooth contours and precise button guidance Max. 12V (1,5A) , min. 5V (1mA) Ø 80 x 16 mm Degree of protection IP40 Incl. PROTECT 150 VA Surface mounting with pre-mounting panel
ETA S 100 LEDws	55542	Storey plate <ul style="list-style-type: none"> surface mounting Diameter 80 x Depth 28 mm incl. PROTECT 210 LED
ETA S 100 LEDbl	55543	Storey plate <ul style="list-style-type: none"> surface mounting Diameter 80 x Depth 28 mm incl. PROTECT 220 LED

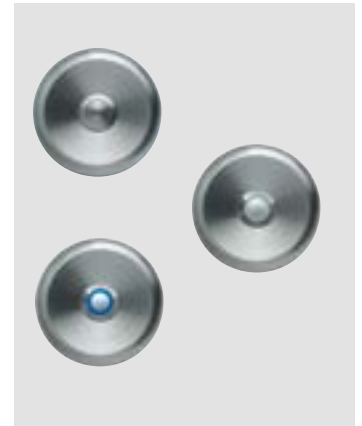

Stainless steel storey plate, cornered

Type	Order no.	Description
ETA S 200	55541	Storey plate <ul style="list-style-type: none"> like ETA S 100, but 82 x 82 x 16 mm
ETA S 200 LEDws	55544	Storey plate <ul style="list-style-type: none"> like ETA S 100, but surface mounting 82 x 82 x 28 mm incl. PROTECT 210 LED
ETA S 200 LEDbl	55545	Storey plate <ul style="list-style-type: none"> like ETA S 100, but surface mounting 82 x 82 x 16 mm incl. PROTECT 220 LED



TORK 2060 gate contact

Type	Order no.	Description
TORK 2060	64151	Gate contact

Description

- Surface-mounted installation
- Incl. PROTECT 340 GO
- Brushed brass surface
- Cable insertion at side or rear
- For cable gland M16

Technical data

- Temperature range: -20 to +50°C
- IP44 (for use outdoors)
- Max. 12V (1,5A) , min. 5V (1mA)
- Diameter 68 mm, depth 30 mm



Designer storey plates made of stainless steel

Description

- Bell plates with a noble look
- Modern and prestigious design in shape, colour and material
- Stainless steel and stainless steel-acrylic variants
- Mounting panel for perfect alignment
- Incl. neoprene sealing on rear for both sealing and compensating unevenness

Technical data

- Max. 12V (1,5A) , min. 5V (1mA)
- IP44
- Incl. PROTECT 150 VA

Type	Order no.	Description
ETA S 102	55912	Storey plate 4 mm <ul style="list-style-type: none"> Material: stainless steel (V2A) Dimensions: D 90 mm Shape: round
ETA S 202	55922	Storey plate 4 mm <ul style="list-style-type: none"> Material: stainless steel (V2A) Dimensions: 75 x 75 mm Shape: square
ETA S 302	55932	Storey plate 4 mm <ul style="list-style-type: none"> Material: stainless steel (V2A) Dimensions: 150 x 60 mm Shape: oval
ETA S 402	55942	Storey plate 4 mm <ul style="list-style-type: none"> Material: stainless steel (V2A) Dimensions: 95 x 65 mm Shape: rectangular

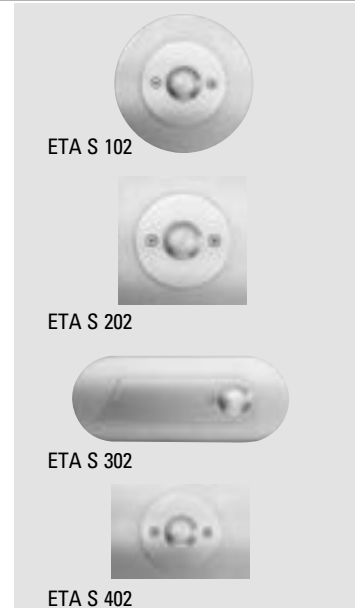

MISTRAL Wireless bell button SE03 can be connected with a dry contact to get a wireless solution with a more stylish bell button.

Contact shells KS 2070-2084



Description

- Sturdy metal shell
- Flush-mounted installation
- Incl. PROTACT button
- Large selection of surfaces
- Mounting on commercially-available flush-mounting box possible (screw distance 60 mm)

- Colour-coordinated countersunk wood screws included in delivery
- Max. 12 V (1,5 A) , min. 5 V (1 mA)
- Diameter 70 mm x Depth 28 mm

Model	Order no.	Description
KS 2070 MS-GL	64131	Contact shell • Shiny brass • with PROTACT 340 GO
KS 2071 MS-AGL	64132	Contact shell • Shiny anthracite brass • with PROTACT 371 NI
KS 2074 WS	64141	Contact shell • White-painted brass • with PROTACT 340 GO
KS 2077 WS SI	64145	Contact shell • White-painted brass • with PROTACT 360 CR
KS 2075	64143	Contact shell • Matt chrome-plated brass • with PROTACT 310 AL
KS 2076	64144	Contact shell • Shiny chrome-plated brass • with PROTACT 360 CR

Cast brass button 2310/2312

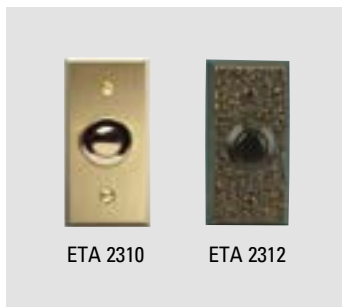

Description

- Surface-mounted installation
- 1 bell button
- Incl. Protact button

Technical data

- Temperature range: -20 to +50°C
- Max. 12V (1,5A) , min. 5V (1mA)
- 65 x 35 x 10 mm

Model	Order no.	Description
ETA 2310	55595	ETA cast brass • Brushed brass
ETA 2312	55597	ETA cast brass • Textured and burnished brass

Contact shells



Model	Order no.	Description
KKO 2018	64033	Contact shell • Surface-Mounted installation • Colour: Silver • Max. 24 V 2,5 A • Dimensions: 61 x 26 x 28 • Packaging: 10 pcs
KKO 2019	64034	Contact shell • Surface-Mounted installation • Metal Casing • Nameplate • Max. 24 V 2,5 A • Dimensions: 61 x 26 x 28 • Packaging: 10 pcs

Cast bronze storey plates



ETA 502 G

Type	Order no.	Description
ETA 501 G	55511	Storey plate <ul style="list-style-type: none"> • Cast bronze/1 bell button • Surface-mounted installation • Recessed and burnished small brass frame • incl. PROTECT 420 AL-KS
ETA 502 G	55512	Storey plate <ul style="list-style-type: none"> • Cast bronze / 2 bell button

Cast aluminium storey plates



ETA 501 GA

Type	Order no.	Description
ETA 501 GA	55531	Storey plate <ul style="list-style-type: none"> • Aluminium/silver anod. EV1 • 1 bell button • Surface-mounted installation • Recessed small aluminium frame • incl. PROTECT 410 AL
ETA 502 GA	55532	Storey plate <ul style="list-style-type: none"> • Aluminium/silver anod. EV1 • 2 bell buttons
ETA 503 GA	55533	Storey plate <ul style="list-style-type: none"> • Aluminium/silver anod. EV1 • 3 bell buttons

Aluminium storey plates ETA 801–809 single row

Description

- Aluminium, silver anodised
- Flush-mounted installation
- Can be illuminated
- For number of panel buttons, see ordering overview
- Incl. 1 light sign (red)
- Weatherproof

Technical data

- Temperature range: -20 to +50 °C
- Soffite LED 7 mA (12 V), 8–12 V AC/DC
- Max. 24 V AC (5 mA–1.5 A/24 VA), max. 24 V DC (5 mA–1.0 A/12 W)
- Fixing holes: 16 mm from outer edge in each case

Note

- Order Tubular bulbs 2130 or soffites LED 2030 separately

Type	Order no.	Description	PU
ETA 801 EV1	55801	Storey plate • 1 button panel • 72 x 121 mm	
ETA 802 EV1	55802	Storey plate • 2 button panel • 96 x 121 mm	
ETA 803 EV1	55803	Storey plate • 3 button panel • 120 x 121 mm	
ETA 804 EV1	55804	Storey plate • 4 button panel • 144 x 121 mm	
ETA 805 EV1	55805	Storey plate • 5 button panel • 168 x 121 mm	
ETA 806 EV1	55806	Storey plate • 6 button panel • 192 x 121 mm	
ETA 807 EV1	55807	Storey plate • 7 button panel • 216 x 121 mm	
ETA 808 EV1	55808	Storey plate • 8 button panel • 240 x 121 mm	
ETA 809 EV1	55809	Storey plate • 9 button panel • 264 x 121 mm	
Accessories			
UPK 801	55881	Flush-mounted box • For 1 button panel • 52 x 104 x 54 mm	
UPK 802	55882	Flush-mounted box • For 2 button panel • 78 x 104 x 54 mm	
UPK 803	55883	Flush-mounted box • For 3 button panel • 102 x 104 x 54 mm	
UPK 804	55884	Flush-mounted box • For 4 button panel • 126 x 104 x 54 mm	
UPK 805	55885	Flush-mounted box • For 5 button panel • 150 x 104 x 54 mm	
UPK 806	55886	Flush-mounted box • For 6 button panel • 174 x 104 x 54 mm	
UPK 807	55887	Flush-mounted box • For 7 button panel • 198 x 104 x 54 mm	
UPK 808	55888	Flush-mounted box • For 8 button panel • 222 x 104 x 54 mm	
UPK 809	55889	Flush-mounted box • For 9 button panel • 246 x 104 x 54 mm	
SOFFITTE 2130	51016	Replacment Tubular Bulb • 17 V (0.1A) • max. 12 V AC/DC (0,00 5–1,5 A)	5
Sofit 2030 LED	51037	Replacement sofit LED • 8–12 V AC/DC, 7 mA (12 V) for socket 98017	5
KKO 2112 BR	51006	Panel button • max. 24 V AC (1.5 A) / 24 V DC (1.0 A) • 21 x 70 x 17 mm, plate 2.5 mm	3



ETA 803 EV1



UPK 802

Aluminium storey plates ETA 833–867 double row



ETA 856 EV1

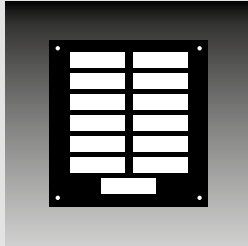

max. 13 buttons



UPK 856-866



Tubular Bulb 2130



Soffitte 2030 LED

Description

- Aluminium, silver anodised
- Flush-mounted installation
- Can be illuminated
- For number of panel buttons, see below
- Incl. 1 light sign (red)
- Weatherproof

Technical data

- Temperature range: -20 to +50 °C
- Soffite LED 7 mA (12 V), 8–12 V AC/DC
- Max. 24 V AC (5 mA–1.5 A/24 VA)
- Max. 24 V DC (5 mA–1.0 A/12 W)
- Fixing holes: 16 mm from outer edge in each case

Note

- Order tubular bulb 2130 or soffites LED 2030 separately
- Order flush-mounted box (galvanized sheet iron) separately

Type	Order no.	Description	PU
ETA 833 EV1	55826	Storey plate • 6 button panel	• 120 x 202 mm
ETA 834 EV1	55827	Storey plate • 7 button panel	• 144 x 202 mm
ETA 844 EV1	55828	Storey plate • 8 button panel	• 144 x 202 mm
ETA 845 EV1	55829	Storey plate • 9 button panel	• 168 x 202 mm
ETA 855 EV1	55830	Storey plate • 10 button panel	• 168 x 202 mm
ETA 856 EV1	55831	Storey plate • 11 button panel	• 192 x 202 mm
ETA 866 EV1	55832	Storey plate • 12 button panel	• 192 x 202 mm
ETA 867 EV1	55833	Storey plate • 13 button panel	• 216 x 202 mm
Accessories			
UPK 833	55893	Flush-mounted box • For 6 button panel	• 101 x 185 x 54 mm
UPK 834/844	55894	Flush-mounted box • For 7/8 button panel	• 125 x 185 x 54 mm
UPK 845/855	55895	Flush-mounted box • For 9/10 button panel	• 149 x 185 x 54 mm
UPK 856/866	55896	Flush-mounted box • For 11/12 button panel	• 173 x 185 x 54 mm
UPK 867	55897	Flush-mounted box • For 13 button panel	• 197 x 185 x 54 mm
SOFFITTE 2130	51016	Replacement Tubular Bulb • 17 V (0.1A) • max. 12 V AC/DC (0,00 5–1,5 A)	5
Soffitte 2030 LED	51037	Replacement soffit LED • for socket 98017	5 • 8–12 V AC/DC, 7 mA (12 V)
KKO 2112 BR	51006	Panel button	3 • max. 24 V AC (1.5 A) / 24 V DC (1.0 A) • 21 x 70 x 17 mm, plate 2.5 mm

Design examples



We can make customised products based on the styles of our standard product range (delivery times available on request, generally 15–25 working days)

We are happy to advise you on the assembly and installation of the door station. Contact our Service hotline:

Phone: +49 (0) 22 42 8890-56
 Fax: +49 (0) 22 42 8890-37
 service@grothe.de

Please specify the following planning features. We recommend you use the inquiry form at the end of the catalogue for this purpose:

Storey plate:

- Dimensions of the storey plate
- Arrangement of the contacts on the storey plate
- Surface or flush-mounted installation
- Fold-out front plate with hinge fixture
- With and without nameplate illumination

Contacts:

- Type and number of contacts required
- Colour of the contacts within the framework of the delivery product range
- Version with separate light button

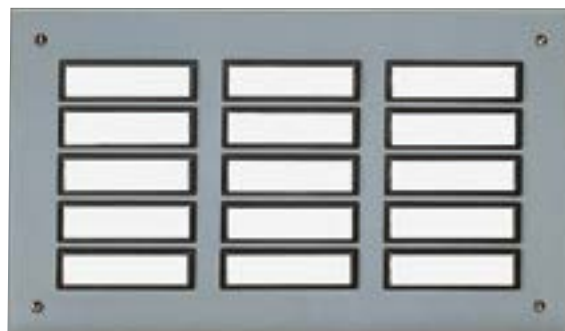

Montilux



Description

- Surface-mounted installation
- 1 bell button
- Modern design
- White (RAL 9010)
- Illuminated (LED)
- Easy mounting with terminal clamp (max. 0.8 mm)
- Weatherproof plastic housing

- Durable special contacts with precious metal coating

Technical data

- Temperature range: -20 to +50°C
- Max. 12V AC/DC 5 mA–1.5 A
- 32 x 90 x 18.5 mm

Type	Order no.	Description	PU
MONTILUX	51011	Montilux	10
Lux bulb	98191	Replacement bulb for old version without LED	10

Combifix II/Combilux



Description

- Surface-mounted installation
- For lighting, see ordering overview
- 1 bell button (friction contact)
- Arrangement in rows possible (connector clips included in scope of delivery)

- White
- Weatherproof

Technical data

- Temperature range: -20 to +50°C
- Max. 12V AC/DC (5mA–1.5A)
- 32 x 90 x 18 mm

Type	Order no.	Description	PU
ETA 2132	51015	Combilux • Illuminated • LED included	10
ETA 2122	51014	Combifix II	10
SOFFITTE 2130	51016	Replacement tubular bulb • for old version without LED • max. 12 V AC/DC, 0.005–1.5A	10
Soffitte 2030 LED	51037	Replacement sofit LED • for old version without LED • 8–12 V AC/DC, 7 mA (12 V)/7V	5

Combifix



COMBIFIX

Description

- Surface-mounted installation
- 1 bell button
- Arrangement in rows possible (connector clips included in delivery)
- White
- Weatherproof

Technical data

- Temperature range: -20 to +50°C
- Max. 24 V AC (5 mA–1.5 A/24 VA)
- Max. 24 V DC (5 mA–1.0 A/12 W)
- 32 x 90 x 18 mm

Type	Order no.	Description	PU
ETA 2121	51013	Combifix	10

KKO button with illumination

Description

- Surface-mounted installation
- LED illumination (wear-free)
- Modern, attractive design
- Large selection of colours and metallic effects (button transparent in each case)
- Weatherproof plastic housing
- Durable special contacts with precious metal coating
- Type of packaging: 1 / 10 per blister (see table)

Technical data

- Temperature range: -20 to +50°C
- 8–24V AC (1.5A/24VA)
- LED approx. (20 mA)
- 65 x 25 x 20 mm

Note

- Not suitable for bell systems with electronic chimes, as the contact and LED are connected in parallel!

Model	Order no.	Description
KKO L 2001 WS/T	64070	Bell button • White / White
KKO 2005	64035	Bell button • Black / White 10/PU
KKO 2005 W	64036	Elegant bell button • White / White 10/PU
KKO 2002 WS	64085	Bell button • Surface-Mounted Installation • Colour: White / White • Synthetic Casing • 3 connection ports • Illuminated Bell Button (LED) • 8-12 V AC/DC • Illuminated Nameplate (LED) • Dimensions 60 x 40 x 20 mm
KKO 2002 SW	64086	Bell button • Surface-Mounted installation • Colour: Black / White • Synthetic Casing • 3 connection ports • Illuminated Bell Button (LED) • 8-12 V AC/DC • Illuminated Nameplate (LED) • Dimensions 60 x 40 x 20 mm



Domolux

Description

- Surface-mounted installation
- 1 bell button
- Modern, attractive design
- Illuminated by LED (incl. in delivery)
- Easy mounting with terminal clamp (max. 0.8 mm)

- Weatherproof Synthetic Casing
- Durable contacts/Metal coating

Technical data

- Temperature range: -20 to +50 °C
- Max. 12 V AC/DC 5 mA–1.5 A
- 90 x 90 x 18.5 mm

Model	Order no.	Description	PU
DOMOLUX WS/SW	51103	Domolux • Black/White (RAL 9010/9005)	
DOMOLUX SIM/SW	51113	Domolux • Black/Silver Matt finish (RAL 9005) • Metal coating	
Lux bulb	98191	Replacement bulb for old version without LED	10



Domolux Duo

Description

- Surface-mounted installation
- 2 bell buttons
- Modern, attractive design
- Illuminated Bulb (incl. in delivery)
- Easy mounting with terminal clamp (max. 0.8 mm)

- Weatherproof Synthetic Casing
- Durable contacts/Metal coating

Technical data

- Temperature range: -20 to +50°C
- Max. 12V AC/DC (AC/DC) 5mA–1.5A
- 90 x 90 x 18.5 mm

Model	Order no.	Description	PU
DOMOLUX DUO WS/SW	51203	Domolux Duo • Black/White (RAL 9010/9005)	
DOMOLUX DUO SIM/SW	51213	Domolux Duo • Black/Silver matt finish (RAL 9005) • Metal coating	
Lux bulb	98191	Replacement bulb	10



Classic storey plate



ETA 634 WS

Description

- Surface-mounted installation
- Can be illuminated
- Weatherproof plastic
- White
- Panel button with nameplate in accordance with post-office recommendations

Technical data

- Temperature range: -20 to +50 °C
- Max. 12 V AC/DC) 5 mA–1.5 A
- Soffite LED 7 mA (12 V), 8–12 V AC/DC

Note

- Order tubular bulb 2130 or soffites LED 2030 separately

Type	Order no.	Description	PU
ETA 631 WS	55631	Classic storey plate • 1 panel button	• 48 x 100 x 25 mm
ETA 632 WS	55632	Classic storey plate • 2 panel buttons	• 72 x 100 x 25 mm
ETA 633 WS	55633	Classic storey plate • 3 panel buttons	• 96 x 100 x 25 mm
ETA 634 WS	55634	Classic storey plate • 4 panel buttons	• 120 x 100 x 25 mm
Soffitte 2030 LED	51037	Replacement soffit LED • for socket 98017	5/unit • 8–12 V AC/DC, 7 mA (12 V)
SOFFITTE 2130	51016	Replacement tubular bulb • for old version without LED	10 • max. 12 V AC/DC, 0.005–1.5A

Button KKO 5050



Description

- White plastic
- Self-cleaning friction contact
- Max. 24V AC (5mA–1.5A/24VA)

- Max. 24 VDC (5 mA–1.0 A/12 W)
- Round
- 50 mm x 20 mm

Type	Order no.	Description	PU
KKO 5050	64025	Button	10

KKO/Golf button



WS/WS

Description

- Surface-mounted installation
- Modern, attractive design
- Large selection of colours and metallic effects
- Weatherproof plastic housing
- Durable special contacts with precious metal coating

Technical data

- Temperature range: -20 to +50°C
- Max. 24 V AC (5 mA–1.5 A/24 VA)
- Max. 24 V DC (5 mA–1.0 A/12 W)
- 65 x 25 x 20 mm

Type	Order no.	Description	PU
KKO 2001 WS/WS	64032	Golf bell button • White	10
KKO 2001 WS/WS	64090	Golf bell button • White	• Contents of packaging: 1 item (blister)

Bell suspended button



Description

- white plastic
- Operator-friendly shape (hospital bell button)
- With collar as button protection

- Self-cleaning friction contacts
- Max. 24V AC (5mA–1.5A/24VA)
- Max. 24V= (5mA–1.0A/12W)
- ø 36 x 67 mm

Type	Order no.	Description	PU
KKO 3736A	64063	Bell suspended button	10

Sliding contact



Description

- Insulating duct edge shield
- Steel springs
- Silver contacts

Technical data

- 32 x 80 x 14 mm
- max. 12V AC (5 mA - 1,0 A /12 VA)
- max. 12V= (5 mA - 1,0 A /12 W)

Type	Order no.	Description	PU
KKO 152B	64114	Sliding contact	1

Door Opener



»Access to modern living comfort«

Door Opener

We open doors for you.

No intercom system without door opener! Thanks to the unlocking function, you can open the door for your visit in a relaxed manner. With Grothe door openers you are only a small lever away from modern living comfort.

Arresting / Releasing



Function of (impermanant) arrester

When the door opener button is pressed the lock installed in the door opener is overridden for a specified period of time to enable the door to be opened a single time.

If the door closes again, the mechanical lock function is automatically activated again.

Advisable for direct-current operation, as here the electrical release is not audible in contrast to the alternating current mode (humming noise).

Function of (permanent) release mechanism

The mechanical release mechanism installed in the door opener enables the door to be kept open for as long as required or to return it to its normal function simply by moving a small lever or turning an adjusting screw (depending on model).

This is advisable in buildings with restricted office hours (doctor's practice etc.).

Standard door opener with large box

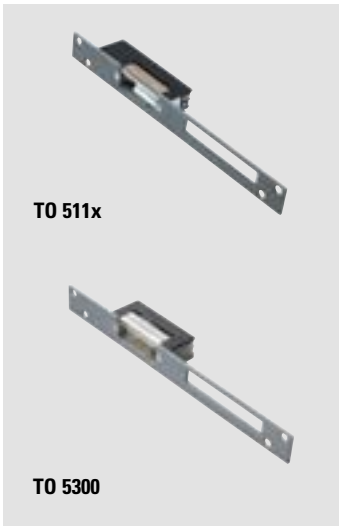

Description

- For type of function, see ordering overview
- DIN links — (can be used asymmetrically on the right and left)
- Compact design
- Perforated closing panel

Technical data

- 8–12 V AC/DC (0.8A)
- Closing panel 250 x 25 x 3 mm
- Latch length 46 mm
- Box dimensions 28 (depth) x 90 x 20 mm
- Short-term load 20 sec.

Type	Order no.	Description
TO 5110	93012	Door opener • Standard
TO 5111	93013	Door opener • arrester mechanism
TO 5112	93014	Door opener • release mechanism
TO 5113	93015	Door opener • arrester and release mechanisms

Standard door opener with small box

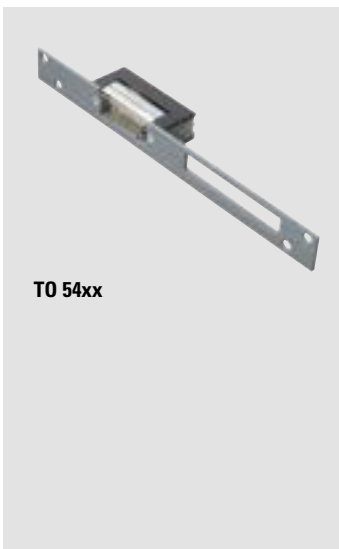

Description

- For type of function, see ordering overview
- Symmetric design (can be used on the right and left)
- Compact design
- Perforated closing panel

Technical data

- 8–12 V AC/DC (0.7A)
- Closing panel 250 x 25 x 3 mm
- Latch length 46 mm
- Box dimensions 28 (depth) x 70 x 20 mm
- Short-term load 20 sec.

Type	Order no.	Description
TO 5300	93011	Door opener • adjustable latch • 6–12 V AC/DC (0,75–1 A) • 1.0 A (at 12 V)
TO 5400	93081	Door opener • adjustable latch
TO 5411	93082	Door opener • adjustable latch and arrester mechanism
TO 5412	93083	Door opener • adjustable latch and release mechanism
TO 5413	93084	Door opener • adjustable latch and release mechanism and arrester mechanism

Door opener for use outdoors



Description

- Protected against water and dust penetration (IP54)
- DIN left, DIN right
- Perforated closing panel

- Closing panel 250 x 25 x 3 mm
- Latch length 44 mm
- Box 35 (depth) x 99 x 20 mm
- Short-term load 20 sec.

Technical data

- 12 V AC/DC 20 Ohm

Note

- Not suitable for combination with angled closing panel!

Type	Order no.	Description
TO 5900-L	93090	Door opener with arrester mechanism • DIN left
TO 5900-R	93091	Door opener with arrester mechanism • DIN right

Compact door opener

Description

- Compact door opener with short closing panel
- DIN links — (can be used asymmetrically on the right and left)
- Perforated closing panel

- Box 28 (depth) x 90 x 20 mm
- Closing panel 160 x 25 x 3 mm
- Latch length 46 mm
- Short-term load 20 sec.

Technical data

- 8-12 V AC/DC (0.8A) 0.8A (at 12V)

Note

- Not suitable for combination with angled closing panel!



TO 5116

Type	Order no.	Description
TO 5116	93114	Door opener • grey

Door openers with electric release mechanism

Description

- Ideal for business premises, doctor's practices etc.
- Release of latch through sustaining voltage (during visiting hours, the door can be opened or closed as often as desired without pressing a button)
- Normal door opener function when sustaining voltage switched off

- DIN links — (can be used asymmetrically on the right and left)
- Perforated closing panel

Technical data

- 8 V DC (0.2A)
- Box 28 (depth) x 90 x 20 mm
- Closing panel 250 x 25 x 3 mm
- Latch length 44 mm



TO 5110 E

Type	Order no.	Description
TO 5110 E	93071	Door opener

No-load current door opener

Description

- Ideal, e.g. for escape doors
- Release of latch if power supply malfunctions
- Locking of latch if power supply switched on
- DIN links — (can be used asymmetrically on the right and left)
- Perforated closing panel

Technical data

- 24 V DC (0.11A)
- Box 29 (depth) x 99 x 20 mm
- Closing panel 250 x 25 x 3 mm
- Latch length 47 mm
- Up to 1000 kg pressure force



TO 5134

Type	Order no.	Description
TO 5134	93061	No-load current door opener

Box-type door opener

Description

- Ideal for box-type and screwed-on locks
- Can be used on the right and left
- Perforated closing panel

- Closing panel 132 x 52 x 3 mm
- Latch length 44 mm
- Box 62 (depth) x 132 x 24 mm
- Short-term load 20 sec.

Technical data

- 12 V AC/DC 30 Ohm

Note

- Not suitable for combination with angled closing panel!



TO 5600

Type	Order no.	Description
TO 5600	93021	Box-type door opener

Chain pull door opener

Description

- For box-type locks with pull button
- Can be used on the right and left
- Included in the delivery specification: chain (approx. 1 m), clamping device, adjusting screw, 4 S-hooks

Technical data

- 12 V AC
- Box 62 (depth) x 120 x 25 mm
- Short-term load 20 sec.



TO 5200

Type	Order no.	Description
TO 5200	93031	Chain pull door opener

Angled closing panel

Type	Order no.	Description
TO WSB DIN L	93098	Angled closing panel • For left-hand arresters • Length 250 mm
TO WSB DIN R	93099	Angled closing panel • For right-hand arresters • Length 250 mm



TO WSB DIN L

Spare parts for door stations

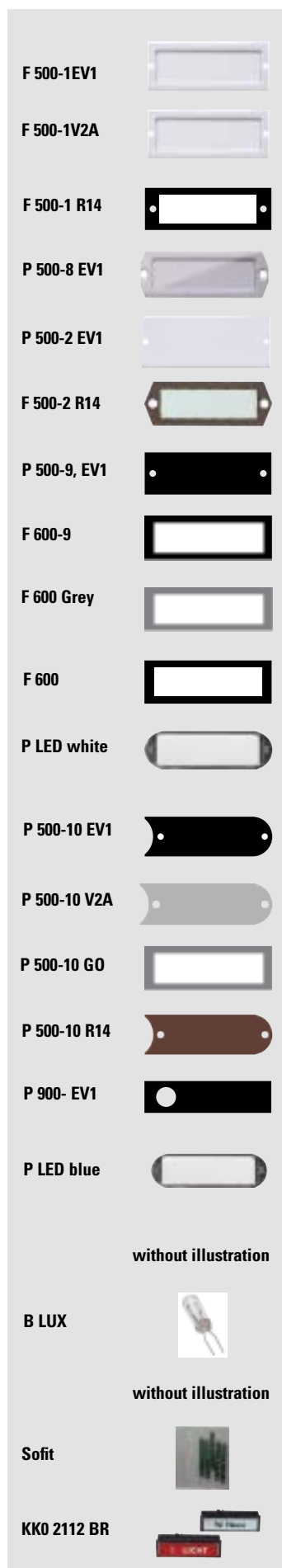

without illustration

without illustration

Type	Order no.	Description	PU
SMALL FRAME 500-1EV1	98009	Small frame • silver anodised • with protection plate/screws	10 • 20 x 58 mm, Protection plate 13 x 43 mm
SMALL FRAME 500-1V2A	98010	Small frame • Brushed stainless steel • with protection plate/screws	5 • 20 x 58 mm, Protection plate 13 x 43 mm
SMALL FRAME 500-1 R14	98012	Small frame • brown anodised • with protection plate/screws	10 • 20 x 58 mm, Protection plate 13 x 43 mm
ENGRAVED PLATE 500-8 EV1	98035	Engraved plate • silver anodised • with screws	10 • 20 x 58 mm
SMALL FRAME 500-2 EV1	98002	Small frame • silver anodised • with protection plate/screws	10 • 20 x 58 mm, Protection plate 13 x 43 mm
SMALL FRAME 500-2 R14	98005	Small frame • brown anodised • with protection plate/screws	10 • 20 x 58 mm, Protection plate 13 x 43 mm
ENGRAVED PLATE 500-9 EV1	98013	Engraved plate • silver anodised • with screws	10 • 20 x 58 mm
SMALL FRAME 600 BLACK	98025	Small frame • Clamped small frame, black	10 • 20 x 57.5 mm, Protection plate 13 x 48 mm
SMALL FRAME 600 GREY	98023	Small frame • Clamped small frame, grey	10 • 20 x 57.5 mm, Protection plate 13 x 48 mm
SMALL FRAME 600	98054	Small frame • Clamped small frame, white	10 • 20 x 57.5 mm, Protection plate 13 x 48 mm
LED nameplate	98056	LED nameplate • 4 x LED white • resistant to vandalism, IP54	• 8–16 V AC/DC (0,02–0,04 A) • Name plate 13 x 43 mm, 23 x 61 x 14 mm
ENGRAVED PLATE 500-10 EV1	98061	Engraved plate • silver anodised • with screws	10 • 20 x 62 mm
ENGRAVED PLATE 500-10 V2A	98062	Engraved plate • Brushed stainless steel • with screws	5 • 20 x 62 mm
ENGRAVED PLATE 500-10 GO	98063	Engraved plate • Gold-plated brass • with screws	5 • 20 x 62 mm
ENGRAVED PLATE 500-10 R14	98064	Engraved plate • brown anodised • with screws	10 • 20 x 62 mm
ENGRAVED PLATE 900 EV1	98032	Engraved plate • silver anodised • for ROBUSTA 900 Series	5 • 20 x 77 mm, Protection plate 12 x 53 mm
LED nameplate	98065	LED nameplate • 4 x LED blue • resistant to vandalism, IP54	• 8-16V AC/DC (0,02-0,04A) • Name plate 13x43 mm, 23x61x14 mm
BULB 1327	98020	Bulb • Replacement lamp for signal button SIT 1325S • Operating voltage: 12 V AC/DC	10 • Characteristics: 24V/50mA • Socket E10
Bulb lux	98191	Replacement bulb • Package contents:10 units • (price quoted per item)	10 • 17 V
LIGHT SIGN	51026	Light sign, red • for panel button • KKO 2112 BR (Order no. 51006)	10
Sofit	51037	Sofit	5 •with replacement LED
SOFFITTE 2130	51016	Replacement tubular bulb • for old version without LED	10 • max. 12 V AC/DC, 0.005–1.5A
KKO 2112 BR	51006	Panel button	3 • max. 24 V AC (1.5 A) / 24 V DC (1.0 A) • 21 x 70 x 17 mm, plate 2.5 mm

GENERAL DATA

Inquiry no. _____
 Targetdate _____
 Date _____

Sender: please fill out completely or use stamp

Company _____
 Person responsible _____
 Street _____
 Postcode, City _____
 Tel.: _____
 Fax _____
 e-mail _____

To.

GROTHE GmbH
 Angebotsabteilung
 Löhestraße 22

D-53773 Hennef

FAX + 49 22 42 - 88 90 - 35
TEL + 49 22 42 - 88 90 - 56

STYLE

<p>Style</p> <p><input type="checkbox"/> doorstation / front plate <small>(already prepared for fitting loudspeaker of all current producers)</small></p> <p><input type="checkbox"/> Storey plate / Bell plate</p> <p>Fixation</p> <p><input type="checkbox"/> plate with flush-mounted box <input type="checkbox"/> dimensions flush-mounted box (if fixed)</p> <p>height: mm width: mm</p>	<p>Colour / Material</p> <p><input type="checkbox"/> Aluminium</p> <p> <input type="checkbox"/> EV1 - silver anodized</p> <p> <input type="checkbox"/> R14 - brown anodized</p> <p><input type="checkbox"/> V2A - stainless steel brushed</p> <p><input type="checkbox"/> GO - brass gold-plated</p> <p><input type="checkbox"/> plate with finery box <small>(flush-mounted box with particular facing, only EV1, R14, V2A)</small></p> <p>Finery box is backwards always closed</p>	<p>Overall dimension</p> <p>height: mm width: mm</p> <p><input type="checkbox"/> plate without box</p> <p> <input type="checkbox"/> with drill holes inside micrometer: height: mm width: mm</p> <p> <input type="checkbox"/> without drill holes</p>
--	---	---

Mark with a cross where applicable

LAYOUT

Standard series (individual set on page 2)

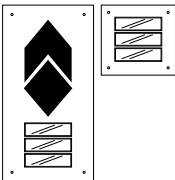
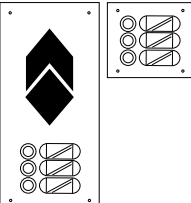
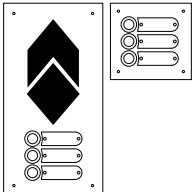
<p><input type="checkbox"/> Series 800</p> 	<p><input type="checkbox"/> ROBUSTA LED</p> 	<p><input type="checkbox"/> RobustaPlus</p> 
--	---	---

Assembly of push buttons

Quantity of push buttons in total:

vertical assembly:

one line three lines
 two lines lines

horizontal assembly:

push buttons in 1 st. line.....
 push buttons in 2 nd. line.....
 push buttons in 3 rd. line.....
 more

Inquiry no. _____

Targetdate _____

Date _____

Company _____

Person responsible _____







Address _____

Individual arrangement

Buttons

- PROTACT 150 VA KKO 2112 BR
- PROTACT 140 GO PROTACT 310 AL
- PROTACT 110 AL PROTACT 340 GO
- PROTACT 450 VA PROTACT 360 CR
- PROTACT 410 AL PROTACT 510 AL
- PROTACT 420 AL-KS
- others

Small Frames / Name Plates

- engraved plate 500-8  EV1, R14
- engraved plate 500-9  EV1, R14
- engraved plate 500-10  EV1, R14, V2A, GOLD
- small frame 500-1  EV1, R14, V2A
- small frame 500-2  EV1, R14
- LED name plate  plastic
- clamped frame 600  black/grey/white

Tubular bulb

- without
- PROTACT LED (100,101,102,105)
- like button

Illumination name plates

- without illumination
- back illumination with bulb or LED nameplate

Grating with universal fixation for fitting loudspeaker

Type and System
grating with holes, square

vertical horizontal

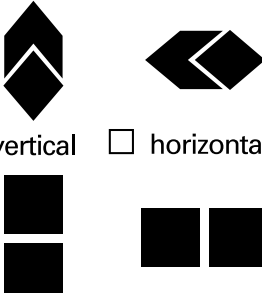

Type and System
grating with holes, round

vertical horizontal

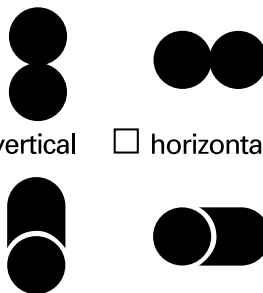

Gravures

- on plate
 - number of signs
 - type size in mm
 - typeface
- typeface as gravures on name plates
 - number of signs (per plate)
 - typeface
 - (size is stated)

Typeface and sizes

- type
- 1 = Helvetica
 - 2 = standard-middle
 - more typefaces on request

LAYOUT OR GRAVURETEXT

Information: if you need further space for your wishes please use an additional sheet. If you have further questions, please give us your telephone number. We will call you immediately.

Telephone number:

Mark with a cross where applicable
technical changes reserved

MOUNTING

GRATING

GRAVURES

As at 01.01.2016

1. Validity clause

Our offers, order acknowledgements, sales, advice, deliveries and services to companies are made solely in accordance with the following conditions. We hereby expressly oppose the use and incorporation of any general terms and conditions of business of the purchaser.

2. Prices, payment and default of the purchaser

2.1. The details contained in our price lists are always suggested recommendations and refer to the given number of items in each case. They do not include any statutory value added tax. In relation to the purchaser, the prices agreed upon by us in the order acknowledgement are authoritative; these prices also do not include value added tax. When the invoice is issued, value added tax will be quoted separately for the amount due on this particular day. This is based on the valid price list at the given time minus any discount agreed upon with the purchaser.

2.2. Unless agreed otherwise, payment is to be made within 30 days from the invoice date without any deduction or within 14 days of the invoice date with a 2% discount.

2.3. Acceptance of cheques or bills of exchange, the latter only with our express permission and for payment of discount charges, interest and other expenses and fees associated with the bill of exchange, is on account of payment only.

2.4. In the event that a payment date is exceeded, the purchaser is in default without any need for a reminder. Subject to assertion of extensive rights, default interest will be charged at 8 percentage points above the respective base rate.

2.5. The purchaser's right of retention is excluded. This does not apply where the right of retention is based on the same contractual relationship as our pecuniary claim or where it is based on stated, approved or undisputed claims that are legally binding or a gross breach of duty on our part.

2.6. Any offsetting by the purchaser is permissible only in conjunction with an undisputed or legally binding claim.

2.7. Should we receive information that makes the granting of credit to the purchaser for the order amount appear risky, or should facts come to light resulting in a deterioration of the purchaser's financial circumstances, if an application to initiate insolvency proceedings is filed, or if the purchaser proposes an out-of-court scheme of arrangement to his creditors, we are entitled to demand immediate payment of our outstanding money. We are also entitled to accelerate all outstanding monies that are not yet due and to demand their immediate payment. Furthermore, in such cases we can also demand advance payment for all as yet outstanding services.

2.8. We are entitled to call on the same rights if the purchaser defaults in part or wholly on a payment and where a purchaser's bill of exchange or a cheque is not cashed.

3. Dispatch, transfer of risks

Unless otherwise requested by the purchaser, goods weighing up to 30 kg are dispatched by parcel service, while goods weighing over 30 kg are dispatched by haulier as freight. Up to a net order value of EUR 300, shipping is charged at EUR 8. For net order values over EUR 300, there is no charge for shipping (for shipping by haulier — free delivery, for shipping by rail — free delivery to recipient's railway station). The risk of carriage transfers to the purchaser as soon as we have delivered the sold goods to the haulier, freight carrier or any other person or agency charged with the task of delivery, including in cases where carriage-free delivery has been agreed. Any complaints with regard to damage during delivery are to be duly made by the purchaser or his nominated recipient to the Post Office, railway or haulier companies.

4. Delivery time, delays

4.1. The delivery time stated by us will be judged to have been adhered to if the goods were shipped or collected within the delivery period.

4.2. Delays in delivery and services owing to force majeure and events with causes outside our sphere of influence, entitle us to postpone the delivery or service for the duration of the impediment plus an appropriate start-up time. If the impediment lasts for longer than three months, both we and the purchaser are entitled to withdraw from the contract with regard to the part of the delivery which has not yet been fulfilled.

4.3. In the event that we default on our service, the purchaser is not entitled to claim damage compensation if the default did not infringe on any essential legally protected interests of the purchaser (life, health) or where the default is a consequence of intent or gross negligence. Here too, we shall only be liable for damages that are typical for such a contract and foreseeable. However, if the default is based on infringement of an essential contractual obligation, we shall be liable for any fault within the scope of damages that are typical for this type of contract and foreseeable. Partial deliveries and corresponding partial invoices are permissible unless it has been otherwise agreed in writing with the purchaser.

5. Guarantee

5.1. For material defects, we shall initially grant a guarantee of our choice in the form of rectification of defects or replacement. The nature of the goods is always deemed to be that as agreed in our product description. Any public statements, blurbs or advertising on our part do not constitute a contractual statement regarding the nature of the goods. Any irrelevant diminution of the value or suitability is out of the question. This also applies to damage or flaws, which are the consequence of natural wear or transportation damage or non-adherence to operating and assembly instructions. Any improper modification to the goods by the purchaser or a third party renders any claim for consequential damage null and void.

5.2. Rebukes due to incorrect delivery, incorrect quantities and obvious defects must be specified in writing by the purchaser immediately, or no later than 10 days from receipt of the goods. Latent faults are to be rebuked as soon as the fault becomes apparent. The deadline is deemed to be observed if sent off in good time. Any infringement of these obligations will preclude any claims against us. The purchaser will bear the full burden of proof for all eligibility criteria, in particular for the fault itself, for the point in time when the fault was detected and for notice of defects in good time.

5.3. Material defect claims expire under statute of limitations in 12 months. This does not apply in those cases where longer deadlines are prescribed by law (§ 438 I No. 2 Structures and Goods for Buildings; § 479 I claim under right of recourse; § 634a I No.2 German Civil Code (BGB) Building faults) as well as in cases of injury to life, body or health, in the event of intentional or grossly negligent breach of duty and for fraudulent concealment of such fault.

5.4. In the event of notice of defects, payment by the purchaser may be withheld by an amount that is of a proportion in keeping with the material defects as detected. The purchaser is only entitled to withhold payment if a notice of defect is put forward, the justification of which cannot be disputed. If a notice of defect is deemed to be unjustified, we are entitled to demand that the purchaser compensate us for any expense incurred by us.

5.5. First of all, we are to be granted an opportunity for supplementary performance within a suitable timeframe. We are entitled to rectify defects or to redeliver several times over. Ownership of all replaced parts will pass to us.

5.6. In the event that any repair or replacement still does not rectify the fault, the purchaser has the option to withdraw from the contract or to reduce payment. All other claims, in particular damage claims, irrespective of the legal basis, are excluded, insofar as we cannot be held liable for intent or gross negligence. Exemption from liability does

not apply insofar as we have guaranteed a specific quality of the goods, which protects the purchaser from any consequential damage.

5.7. Claims under right of a recourse by the purchaser against us as under § 478 German Civil Code only exist insofar as the purchaser has not reached an agreement with his buyers which extends beyond that of statutory claims arising from defects.

5.8. Duly delivered goods can only be taken back with our prior permission. For goods returned with our prior permission we shall issue a credit note for 30% or more of the net amount invoiced, depending upon the condition of the goods, minus administrative costs, inspection and repackaging. Damaged goods and those that are no longer included in the currently valid catalogues and price lists shall not be credited. If a modification to a customised product is requested by the contractor, any costs that have been incurred up to such time must be reimbursed by the ordering party. In the event that an order is cancelled, the ordering party is bound to pay all expenses that have been incurred up to such time. Customised products that have already been delivered will not be taken back.

5.9. We reserve the right to make minor or improvement modifications to the products we supply. Details and illustrations in our catalogues, brochures, price lists, miscellaneous publications or estimates, as well as drawings, specifications and service descriptions of all kinds, dimensions, weights, consumption information etc., are by nature only approximations. They do not contain any information regarding composition or guarantees in any form whatsoever, as long as such statements have not been expressly confirmed by us in writing for an order.

6. Impossibility, contract adaptation

6.1. Insofar as a delivery becomes impossible, the purchaser is entitled to claim damage compensation, unless the reason for impossibility is not one for which we are responsible. However, the ordering party's claim for damages is restricted to 10% of the value of the part of the delivery, which cannot be put into useful service because of the impossibility involved. This restriction does not apply insofar as liability is mandatory in cases of intent, gross negligence or due to harm to life, body or health; this is not combined with any change in the burden of proof to the detriment of the purchaser. The right of the purchaser to withdraw from the contract remains unaffected.

6.2. Insofar as any unforeseen events considerably alter the economic significance or content of the delivery or exert a major influence on our operation, the contract will be suitably adapted taking good faith into consideration. Insofar as this is not economically feasible, we are entitled to withdraw from the contract. In the event that we wish to make use of this right of withdrawal, we shall immediately notify the purchaser of such intention after determining the consequence of the event in question. This includes cases when an extension of the delivery period was initially agreed with the purchaser.

7. Miscellaneous claims for damages

7.1. Claims for damages or compensation of expenditure by the purchaser (hereinafter referred to as: claims for damages), irrespective of the legal basis, in particular due to any infringement of obligations from the contractual obligation and from unlawful acts, are excluded.

7.2. This does not apply in instances of mandatory liability, e.g. in accordance with the Product Liability Act, in the event of intent, gross negligence, harm to life, body or health, or due to the infringement of essential contractual obligations. Claims for damages for the infringement of contractual obligations, however, are restricted to damage that is foreseeable and typical for the type of contract, insofar as no intent or gross negligence is present or liability exists due to injury to life, body or health. A change in the burden of proof to the detriment of the ordering party is not associated with the preceding regulations.

7.3. Insofar as the purchaser is entitled to claims for damages in accordance with this section, these will lapse with expiry of the statutes of limitations for claims for material defects in accordance with Section 5.3. In the event of claims for damages in accordance with the Product Liability Act, the legal statutes of limitation are binding.

8. Retention of title

8.1. We retain title to the goods we supply until the purchaser has fulfilled all his requirements to us, on open account of each claim for payment of account balance. The purchaser may resell the delivered goods only in the course of normal business transactions and under his standard terms and conditions of business. During the sale, the purchaser agrees on a retention of title to the extent of the clauses 8.1 to 8.7 of these conditions.

8.2. The purchaser may process the delivered goods or combine them with other objects. Processing or combination with movables ensues for us in our role as manufacturer. The purchaser will hold the new item in custody for us with the due care and diligence of a responsible businessman. The processed or combined item is subject to retention of title.

8.3. If the purchaser acquires sole ownership through processing or combining goods, he shall assign co-ownership to us according to the value of our goods incorporated in the new item in proportion to the value of the other components in the new item at the time of installation.

8.4. In the event that the new item should be resold, the purchaser hereby assigns to us all claims from the resale against his buyers as well as all associated subsidiary rights by way of security in the amount that corresponds to the value as invoiced by us for the processed or combined goods. Satisfaction of the assigned claim element is of prime importance. The direct debit mandate and preconditions of their revocation are subject to Section 8.5. of these conditions.

8.5. The claims due to the purchaser from a resale, processing or an installation or any other legal basis (insurance, illegal act etc.) have been assigned to us by way of security. We authorise the purchaser until revoked, to collect the claims assigned to us on his account and in his own name. As soon as the purchaser fails to honour an obligation to us, or one of the circumstances stated in Section 5.9 above comes into effect, we are entitled to revoke the collection authorisation, notify the debtors of the assignment and to demand payment to us.

8.6. If the value of the securities in place for us exceeds our claims in a sustained manner by more than 15% in total, we shall release securities of our choice if called to do so by the purchaser.

8.7. In the event of attachments and confiscation of goods subject to retention of title or enforcements in claims assigned to us, the purchaser must refer to our rights; he must also immediately notify us of these measures and upon threat of default he has to take up, at his own expense, the required legal redress in order to secure our rights.

9. Place of fulfilment, court of jurisdiction, severability clause

9.1. Place of fulfilment is Hennef. Court of jurisdiction is Siegburg. The law of the Federal Republic of Germany is valid. Use of the United Nations Convention on Contracts for the International Sale of Goods is excluded.

9.2. In the event that individual provisions of the contract with the purchaser including these general terms and conditions of business are or become wholly or in part invalid, the validity of the remaining provisions shall remain unaffected by this. The wholly or partly ineffective ruling should be replaced by an effective ruling, the economic success of which is as close as possible the ineffective ruling.

Grothe GmbH

List of types



LIST OF TYPES

Order no.	Type	Description	PU	DC	Page
14034	GT 1973	Safety transformer	1	1	78
14039	GT 3139	Bell transformer	1	1	78
14049	GT 3139 S	Bell transformer	1	1	78
14058	GT 3158	Bell transformer	1	1	78
14073	GT 3173	Bell transformer	1	1	78
14074	GT 3174	Bell transformer	1	1	78
14082	GT 3182	Bell transformer	1	1	78
14083	GT 3173 S	Bell transformer	1	1	78
14101	GT 1975	Safety transformer	1	1	78
14102	GT 1965	Safety transformer	1	1	78
14140	GT 1980	Safety transformer	1	1	79
14160	GT 1990	Safety transformer	1	1	79
14201	GT 3148	Bell transformer	1	1	78
14207	GT 50810	Bell transformer	1	1	78
14211	GT 3148 S	Bell transformer	1	1	78
14936	GT 36 AP	Wall-mounted installation kit	1	1	78
14954	GT 54 AP	Wall-mounted installation kit	1	1	78
14990	GT 90 AP	Wall-mounted installation kit	1	1	78
22512	LTW 742 12V AC	Large bell	1	1	39
22513	LTW 742 24V AC	Large bell	1	1	39
22514	LTW 742 42V AC	Large bell	1	1	39
22517	LTW 742 230V AC	Large bell	1	1	39
22540	LTW 754 12V/DC	Large bell	1	1	39
22541	LTW 754 24V/DC	Large bell	1	1	39
22557	LTW 781 230V AC	Large bell	1	1	39
22580	LTW 793 12V/DC	Large bell	1	1	39
22581	LTW 793 24V/DC	Large bell	1	1	39
24012	SG 851 8-12V AC	Signaller	1	1	37
24017	SG 851 230V AC	Signaller	1	1	37
24052	SU 1170A 8-12V AC	Buzzer	1	1	37
24071	LTW 101A 8V AC	Circular bell	1	1	37
24075	LTW 1101A 8V AC	Small bell	2	1	38
24081	LTW 1171A 8V AC	Bell	1	1	37
24082	LTW 1171A 12V AC	Bell	1	1	37
24083	LTW 1171A 24V AC	Bell	1	1	37
24091	LTW 3371A 230V AC	Small bell	1	1	38
24111	LTW 4471A 8V AC	Small bell	2	1	38
24113	LTW 4477A 8-12V AC	Small bell	1	1	38
24311	LTW 911A 8V AC F	Bell	1	1	38
24331	LTW 911A 24V AC	Bell	1	1	38
24376	LTW 911A 230V AC	Bell	1	1	38
31041	HUPE 630 8V AC	Horn	1	1	41
31043	HUPE 630 24V AC	Horn	1	1	42
31045	HUPE 630 110V AC	Horn	1	1	42
31047	HUPE 630 240V AC	Horn	1	1	42

LIST OF TYPES

Order no.	Type	Description	PU	DC	Page
31053	HUPE 631 12-24V DC	Horn	1	1	42
31101	KSZ OR 100	Lens	1	2	43
31241	HUPE BZ 6311 24V DC	Combi horn	1	1	42
31271	HUPE BZ 6301 240V AC	Combi horn	1	1	43
31341	HUPE WL 6311 24V DC	Combi horn	1	1	42
31371	HUPE WL 6301 240V AC	Combi horn	1	1	43
32012	HUPE 640 12V AC	Large horn	1	1	43
32013	HUPE 640 24V AC	Large horn	1	1	43
32017	HUPE 640 230 V AC	Large horn	1	1	43
32123	HUPE 651 24 V DC	Large horn	1	1	43
33017	HUPE 680 230V AC	Large horn	1	1	47
37302	DSL 7302	Rotating mirror beacon	1	2	62
37307	DSL 7307	Rotating mirror beacon	1	2	47
37322	DSL 7322	Rotating mirror beacon	1	2	63
37327	DSL 7327	Rotating mirror beacon	1	2	62
37332	DSL 7332	Rotating mirror beacon	1	2	63
37337	DSL 7337	Rotating mirror beacon	1	2	63
37352	BLZ-R 7352	Xenon rotation beacon	1	2	64
37357	BLZ-R 7357	Xenon rotation beacon	1	2	63
37361	DSL 7361	Rotating mirror beacon	1	2	63
37362	DSL 7362	Rotating mirror beacon	1	2	64
37381	DSZ 7381	Halogen lamp	1	2	65
37382	DSZ 7382	Halogen lamp	1	2	63
37383	DSZ 7383	Xenon tube	1	2	65
37391	DSZ 7391	Push-on flange	1	2	64
37394	DSZ 7394	Protection basket	1	2	65
37395	DSZ 7395	Wall bracket	1	2	64
37396	DSZ 7396	Bulb	1	2	65
37397	DSZ 7397	Bulb	1	2	64
37410	PSG 4.0-100	Power sounder	1	4	34
37430	PSG 4.0-230F	Power sounder	1	4	37
38001	KSZ 8001	Socket	1	2	58
38002	KSZ 8002	Socket	1	2	37
38003	KSZ 8003	Tube	1	2	58
38004	KSZ 8004	Bracket	1	2	58
38005	KSZ 8005	Bracket	1	2	58
38101	KWL 8101	Warning light	1	2	58
38102	KWL 8102	Warning light	1	2	58
38106	KWL 8106	Warning light	1	2	58
38211	KBZ 8211	Flashing light	1	2	59
38212	KBZ 8212	LED-multi-flashing light	1	2	58
38221	KBZ 8221	LED-multi-flashing light	1	2	59
38222	KBZ 8222	LED-multi-flashing light	1	2	59
38411	MBZ 8411	LED-multi-flashing light	1	2	60
38412	MBZ 8412	LED-multi-flashing light	1	2	59

LIST OF TYPES

Order no.	Type	Description	PU	DC	Page
38421	MBZ 8421	LED-multi-flashing light	1	2	60
38422	MBZ 8422	LED-multi-flashing light	1	2	60
38511	GWL 8511	Warning light	1	2	60
38512	GWL 8512	Warning light	1	2	60
38516	GWL 8516	Warning light	1	2	60
38531	GBZ 8601	Flashing light	1	2	61
38532	GBZ 8602	Flashing light	1	2	60
38541	HBZ 8541 24V DC	Combi flashing light	1	2	62
38542	HBZ 8542 24V DC	Combi flashing light	1	2	61
38551	GBZ 8611	Flashing light	1	2	61
38552	GBZ 8612	Flashing light	1	2	62
38553	GBZ 8621	Flashing light	1	2	61
38554	GBZ 8622	Flashing light	1	2	61
38571	HBZ 8571 240V AC	Combi flashing light	1	2	62
38572	HBZ 8572 240V AC	Combi flashing light	1	2	61
38591	GSZ 8591	Bulb	1	2	65
38592	GSZ 8592	Bulb	1	2	62
38593	GSZ 8593	Bulb	1	2	65
38595	KSZ 8595	Bulb	1	2	65
38596	KSZ 8596	Bulb	1	2	65
38597	KSZ 8597	Bulb	1	2	65
38600	TSZ 8600	Basic unit	1	2	52
38601	KSZ 8601	Mounting base	1	2	65
38603	KSZ 8603	Extension tube	1	2	52
38604	KSZ 8604	Mounting bracket	1	2	52
38605	KSZ 8605	Mounting bracket	1	2	52
38610	MSZ 8610	Basic unit	1	2	56
38620	MSG 8620	Sounder	1	2	52
38621	MWB 8621	LED warning/blinking light	1	2	57
38622	MWB 8622	LED warning/blinking light	1	2	56
38624	MWB 8624	LED warning/blinking light	1	2	57
38625	MWB 8625	LED warning/blinking light	1	2	57
38626	MWB 8626	LED warning/blinking light	1	2	57
38630	MSG 8630	Sounder	1	2	56
38631	MWB 8631	LED warning/blinking light	1	2	57
38632	MWB 8632	LED warning/blinking light	1	2	56
38634	MWB 8634	LED warning/blinking light	1	2	57
38635	MWB 8635	LED warning/blinking light	1	2	57
38636	MWB 8636	LED warning/blinking light	1	2	57
38651	KSZ-LED 8651	LED bulb	1	2	65
38652	KSZ-LED 8652	LED bulb	1	2	57
38654	KSZ-LED 8654	LED bulb	1	2	65
38655	KSZ-LED 8655	LED bulb	1	2	65
38656	KSZ-LED 8656	LED bulb	1	2	65
38661	KSZ-LED 8661	LED bulb	1	2	65

LIST OF TYPES

Order no.	Type	Description	PU	DC	Page
38662	KSZ-LED 8662	LED bulb	1	2	65
38664	KSZ-LED 8664	LED bulb	1	2	65
38665	KSZ-LED 8665	LED bulb	1	2	65
38666	KSZ-LED 8666	LED bulb	1	2	65
38711	TWL 8711	Warning light	1	2	53
38712	TWL 8712	Warning light	1	2	65
38714	TWL 8714	Warning light	1	2	53
38715	TWL 8715	Warning light	1	2	53
38716	TWL 8716	Warning light	1	2	53
38717	TWL 8717	Warning light	1	2	53
38721	TBL 8721	Flashing light	1	2	54
38722	TBL 8722	Flashing light	1	2	53
38724	TBL 8724	Flashing light	1	2	54
38725	TBL 8725	Flashing light	1	2	54
38726	TBL 8726	Flashing light	1	2	54
38727	TBL 8727	Flashing light	1	2	54
38731	TBL 8731	Flashing light	1	2	54
38732	TBL 8732	Flashing light	1	2	54
38734	TBL 8734	Flashing light	1	2	54
38735	TBL 8735	Flashing light	1	2	54
38736	TBL 8736	Flashing light	1	2	54
38737	TBL 8737	Flashing light	1	2	54
38781	TSG 8781	Sounder	1	2	55
38782	TSG 8782	Sounder	1	2	54
38785	TSG 8785	Sounder	1	2	54
38786	TSG 8786	Sounder	1	2	55
38831	TLB 8831	LED flashing light	1	2	52
38832	TLB 8832	LED flashing light	1	2	54
38834	TLB 8834	LED flashing light	1	2	52
38835	TLB 8835	LED flashing light	1	2	52
38836	TLB 8836	LED flashing light	1	2	52
38837	TLB 8837	LED flashing light	1	2	52
38841	TLB 8841	LED flashing light	1	2	53
38842	TLB 8842	LED flashing light	1	2	52
38844	TLB 8844	LED flashing light	1	2	53
38845	TLB 8845	LED flashing light	1	2	53
38846	TLB 8846	LED flashing light	1	2	53
38847	TLB 8847	LED flashing light	1	2	53
38901	SIR 8901RT	Electronic siren	1	2	51
38902	SIR 8902WS	Electronic siren	1	2	53
38903	SIR 8903RT	Electronic siren	1	2	51
38904	SIR 8904WS	Electronic siren	1	2	51
38906	AMP 8906	Traffic light 2 LE	1	2	50
38907	AMP 8907	Traffic light 2 LE	1	2	51
38908	AMP 8908	Traffic light 3 LE	1	2	50

LIST OF TYPES

Order no.	Type	Description	PU	DC	Page
38909	AMP 8909	Traffic light 3 LE	1	2	50
38910	WHA 8910	Bracket	1	2	50
38911	BMF 8911	Basic modul flat	1	2	48
38912	BMT 8912	Basic modul deep	1	2	50
38913	BMW 8913	Basic modul wall	1	2	48
38914	BMT 8914	Basic modul deep	1	2	48
38915	BMW 8915	Basic modul wall	1	2	48
38916	BDW 8916	Basic double modul wall	1	2	48
38917	BDW 8917	Basic double modul wall	1	2	48
38921	MSG 8921	Sound generator modul	1	2	49
38922	MSG 8922	Sound generator modul	1	2	48
38931	MHZ 8931	Combi light modul	1	2	49
38932	MHZ 8932	flashing light LED with sounder	1	2	49
38933	MHZ 8933	Combi light modul	1	2	49
38934	MHZ 8934	flashing light LED with sounder	1	2	49
38941	MWL 8941	Signal lamp LED	1	2	49
38942	MWL 8942	Signal lamp LED	1	2	49
38943	MWL 8943	Signal lamp LED	1	2	49
38944	MWL 8944	Signal lamp LED	1	2	49
38951	MWL 8951	Signal lamp LED	1	2	49
38952	MWL 8952	Signal lamp LED	1	2	49
38953	MWL 8953	Signal lamp LED	1	2	49
38954	MWL 8954	Signal lamp LED	1	2	49
38962	MML 8962	Multi color LED flashing light	1	2	50
38963	MML 8963	Multi color LED flashing light	1	2	49
38966	AMP 8966	Traffic light 2 LE	1	2	50
38967	AMP 8967	Traffic light 2 LE	1	2	50
38968	AMP 8968	Traffic light 3 LE	1	2	50
38969	AMP 8969	Traffic light 3 LE	1	2	50
38991	BMF 8991	Basic modul flat	1	2	48
38992	BMT 8992	Basic modul deep	1	2	50
38993	BME 8993	Basic modul flush mount	1	2	48
38994	BMT 8994	Basic modul deep	1	2	48
38995	BME 8995	Basic modul flush mount	1	2	48
39013	AL 1057/614	Lithium battery 3 V CR123 A	1	2	15
39340	NG AL12/5A	Power supply	1	2	79
39342	NG AL12/2A	Power supply	1	2	79
39343	NG AL24/1A	Power supply	1	2	79
43142	MISTRAL 300M ws	Wireless doorbell kit	1	1	13
43143	MISTRAL 300M sw	Wireless doorbell kit	1	1	83
43144	MISTRAL 300M si	Wireless doorbell kit	1	1	13
43145	MISTRAL 300M rt	Wireless doorbell kit	1	1	13
43146	MISTRAL 300M gn	Wireless doorbell kit	1	1	13
43150	CROMA 50	Electronic doorbell	1	1	24
43152	CROMA 50 ws	Electronic doorbell	1	1	24

LIST OF TYPES

Order no.	Type	Description	PU	DC	Page
43153	CROMA 50 sw	Electronic doorbell	1	1	24
43154	CROMA 50 si	Electronic doorbell	1	1	24
43155	CROMA 50 rt	Electronic doorbell	1	1	24
43156	CROMA 50 gn	Electronic doorbell	1	1	24
43170	CROMA 100A	Electronic doorbell	1	1	22
43172	CROMA 100A ws/ws	Electronic doorbell	1	1	22
43173	CROMA 100A ws/si	Electronic doorbell	1	1	22
43174	CROMA 100A ws/sw	Electronic doorbell	1	1	22
43175	CROMA 230A	Electronic doorbell	1	1	23
43177	CROMA 231A	Electronic doorbell	1	1	23
43182	MISTRAL 200M ws	Wireless doorbell kit	1	1	13
43183	MISTRAL 200M sw	Wireless doorbell kit	1	1	25
43184	MISTRAL 200M si	Wireless doorbell kit	1	1	13
43185	MISTRAL 200M rt	Wireless doorbell kit	1	1	13
43186	MISTRAL 200M gn	Wireless doorbell kit	1	1	13
43190	CROMA 230A-a/aw	Electronic chime	1	1	23
43195	CROMA 231A ws/ws	Electronic chime	1	1	23
43196	CROMA 231A ws/si	Electronic chime	1	1	23
43197	CROMA 231A ws/sw	Electronic chime	1	1	23
43225	GONG 225 A	Electronic chime	1	1	24
43251	Polo Funkgong ws/ws	Wireless chime kit	1	2	16
43252	Polo Funkgong ws/sw	Wireless chime kit	1	2	16
43300	MISTRAL 300M	Wireless chime kit	1	1	13
43301	MISTRAL 300M E	Radio chime receiver	1	1	14
43303	MISTRAL 210M	Wireless chime kit	1	1	13
43305	MISTRAL 200M	Wireless chime kit	1	1	14
43310	MISTRAL 400M	Mains-powered radio chime kit EU	1	1	14
43311	MISTRAL 400M E	Mains-powered radio chime receiver EU	1	1	13
43314	Mistral 400M UK	Mains-powered radio chime kit UK	1	1	14
43315	MISTRAL 300M BM	Wireless chime kitwith PIR	1	1	13
43318	MISTRAL 400M UK S	Mains-powered Plug-in wireles chime UK	1	1	14
43371	MISTRAL 200M ws-si	Wireless chime kit	1	1	13
43372	MISTRAL 300M ws-si	Wireless chime kit	1	1	14
43380	Mistral 800 Mobile SW	Mobile receiver	1	2	15
43381	Mistral 800 Mobile WS	Mobile receiver	1	2	13
43382	MISTRAL Mobile Set SW	Mobile receiver kit	1	2	15
43385	MISTRAL RB Relaisbox	Relais box	1	2	15
43386	Mistral RB Relaisbox Set	Relais box kit	1	2	15
43394	Mistral MK Magnetkontakt	Magnetic contact	1	2	15
43399	NA 9V-GPE	Power supply	1	1	15
43400	MISTRAL 600	Wireless chime kit	1	1	13
43401	MISTRAL 600E	Radio chime receiver	1	1	14
43410	MISTRAL 600 ws	Wireless chime kit	1	1	13
43411	MISTRAL 600E ws	Radio chime receiver	1	1	14
43440	MISTRAL SE03s	Radio transmitter	1	1	13

LIST OF TYPES

Order no.	Type	Description	PU	DC	Page
43441	MISTRAL SE03	Radio transmitter	1	1	14
43445	MISTRAL BM03	Wireless PIR motion detector	1	1	14
43480	Mistral WR Repeater	Wireless repeater	1	2	15
43501	Echo M schwarz	Wireless chime kit ECHO black	1	3	9
43502	Echo M weiß	Wireless chime kit ECHO white	1	3	15
43505	WH ECHO 120/M	Wall bracket ECHO120/M	1	3	9
43515	Echo M - BM schwarz	Wireless chime kit ECHO black	1	3	9
43516	Echo M - BM weiß	Wireless chime kit ECHO white	1	3	9
43530	Echo 120 schwarz	Electronic chime ECHO black	1	3	20
43531	Echo 120 weiß	Electronic chime ECHO white	1	3	20
43540	Echo 230 schwarz	Electronic chime ECHO black	1	3	20
43541	Echo 230 weiß	Electronic chime ECHO white	1	3	20
43550	MISTRAL 350 SW	Wireless chime kit	1	3	12
43551	MISTRAL 350 WS	Wireless chime kit	1	3	22
43552	MISTRAL 650 SW	Wireless chime kit	1	3	12
43553	MISTRAL 650 WS	Wireless chime kit	1	3	12
43554	CROMA 150 SW	Electronic chime	1	3	21
43555	CROMA 150 WS	Electronic chime	1	3	21
43556	CROMA 250 SW	Electronic chime	1	3	21
43557	CROMA 250 WS	Electronic chime	1	3	21
43558	MISTRAL 350E SW	Wireless chime kit	1	3	12
43559	MISTRAL 350E WS	Wireless chime kit	1	3	23
43560	CALIMA 200	Wireless chime kit DE	1	3	7
43561	CALIMA 200 GB	Wireless chime kit GB	1	3	12
43563	CALIMA 200 NL	Wireless chime kit NL	1	3	7
43564	CALIMA 200 BE	Wireless chime kit BE	1	3	7
43701	UP-GONG 120ws	Flush-mounted electronic chime	1	1	28
43706	UP-GONG 230ws	Fush-mounted electronic chime	1	1	28
43711	UP-LTW 120ws	Flush-mounted bell	1	1	28
43716	UP-LTW 230ws	Flush-mounted bell	1	1	28
43721	UP-SU 120ws	Flush-mounted buzzer	1	1	28
43726	UP-SU 230ws	Flush-mounted buzzer	1	1	28
44065	GONG 065 Bw	Chime	1	1	30
44165	GONG 165 Bw	Chime	1	1	30
44169	GONG 169 Bw	Chime	1	1	30
44171	GONG 169 DKw	Chime	1	1	30
44172	GONG 169A TRw	Chime 230	1	1	30
44179	GONG 569-230V	Chime 230	1	1	30
44265	GONG 265 Bw	Chime	1	1	30
44465	GONG 465A Bw/sw	Chime	1	1	30
44466	GONG 465A Bw/w	Chime	1	1	30
44475	Gong 465A-230 ws/sw	Chime 230	1	1	30
44476	Gong 465A-230 ws/ws	Chime 230	1	1	30
44565	GONG 565 Bw/sim	Chime	1	1	30
44569	GONG 569 Bw	Chime	1	1	30

LIST OF TYPES

Order no.	Type	Description	PU	DC	Page
44665	GONG 665 Bw/bl	Chime	1	1	30
51006	KKO 2112 BR	Flat push button	3	1	86
51011	MONTILUX 2154	Montilux	10	1	93
51013	ETA 2121A	Combifix	10	1	93
51014	ETA 2122	Combifix II	10	1	93
51015	ETA 2132A	Combilux	10	1	93
51016	SOFFITTE 2130	Replacement sofit tubular bulb	10	1	91
51026	LICHT-SCHILD	Light sign, red	10	1	100
51037	Soffitte 2030 LED	Replacement sofit LED	5	1	91
51103	DOMOLUX WS/SW	Domolux	1	1	104
51113	DOMOLUX SIM/SW	Domolux	1	1	94
51203	DOMOLUX DUO WS/SW	Domolux Duo	1	1	94
51213	DOMOLUX DUO SIM/SW	Domolux Duo	1	1	94
55511	ETA 501 G	Storey plate	1	1	89
55512	ETA 502 G	Storey plate	1	1	89
55531	ETA 501 GA	Storey plate	1	1	89
55532	ETA 502 GA	Storey plate	1	1	89
55533	ETA 503 GA	Storey plate	1	1	89
55540	ETA S 100	Storey plate	1	2	87
55541	ETA S 200	Storey plate	1	2	87
55542	ETA S100 LEDws	LED storey plate	1	2	87
55543	ETA S100 LEDbl	LED storey plate	1	2	87
55544	ETA S200 LEDws	LED storey plate	1	2	87
55545	ETA S200 LEDbl	LED storey plate	1	2	87
55595	ETA 2310	ETA cast brass	1	1	88
55597	ETA 2312	ETA cast brass	1	1	88
55631	ETA 631 WS	Classic storey plate	1	1	95
55632	ETA 632 WS	Classic storey plate	1	1	95
55633	ETA 633 WS	Classic storey plate	1	1	95
55634	ETA 634 WS	Classic storey plate	1	1	95
55801	ETA 801 EV1	Storey plate	1	1	90
55802	ETA 802 EV1	Storey plate	1	1	90
55803	ETA 803 EV1	Storey plate	1	1	90
55804	ETA 804 EV1	Storey plate	1	1	90
55805	ETA 805 EV1	Storey plate	1	1	90
55806	ETA 806 EV1	Storey plate	1	1	90
55807	ETA 807 EV1	Storey plate	1	1	90
55808	ETA 808 EV1	Storey plate	1	1	90
55809	ETA 809 EV1	Storey plate	1	1	90
55826	ETA 833 EV1	Storey plate	1	1	91
55827	ETA 834 EV1	Storey plate	1	1	91
55828	ETA 844 EV1	Storey plate	1	1	91
55829	ETA 845 EV1	Storey plate	1	1	91
55830	ETA 855 EV1	Storey plate	1	1	91
55831	ETA 856 EV1	Storey plate	1	1	91

LIST OF TYPES

Order no.	Type	Description	PU	DC	Page
55832	ETA 866 EV1	Storey plate	1	1	91
55833	ETA 867 EV1	Storey plate	1	1	91
55881	UPK 801	Flush-mounted box	1	1	90
55882	UPK 802	Flush-mounted box	1	1	90
55883	UPK 803	Flush-mounted box	1	1	90
55884	UPK 804	Flush-mounted box	1	1	90
55885	UPK 805	Flush-mounted box	1	1	90
55886	UPK 806	Flush-mounted box	1	1	90
55887	UPK 807	Flush-mounted box	1	1	90
55888	UPK 808	Flush-mounted box	1	1	90
55889	UPK 809	Flush-mounted box	1	1	90
55893	UPK 833	Flush-mounted box	1	1	91
55894	UPK 834/844	Flush-mounted box	1	1	91
55895	UPK 845/855	Flush-mounted box	1	1	91
55896	UPK 856/866	Flush-mounted box	1	1	91
55897	UPK 867	Flush-mounted box	1	1	91
55912	ETA S 102	Storey plate VA 4 mm	1	2	87
55922	ETA S 202	Storey plate VA 4 mm	1	2	87
55932	ETA S 302	Storey plate VA 4 mm	1	2	87
55942	ETA S 402	Storey plate VA 4 mm	1	2	87
61031	PROTACT 380 KS	Bell button	5	1	95
61032	PROTACT 381 KS	Bell button	5	1	95
61045	PROTACT 681 KS	Bell button	5	1	95
61047	PROTACT 680 KS	Bell button	5	1	95
62000	PROTACT 150 VA	Bell button	5	1	84
62001	PROTACT 140 GO	Bell button	5	1	84
62002	PROTACT 110 AL	Bell button	5	1	84
62006	PROTACT 450 VA	Bell button	5	1	85
62013	PROTACT 420 AL-KS	Bell button	5	1	85
62016	PROTACT 410 AL	Bell button	5	1	85
62025	PROTACT 340 GO	Bell button	5	1	84
62026	PROTACT 370 NI	Bell button	5	1	84
62032	PROTACT 310 AL	Bell button	5	1	84
62033	PROTACT 360 CR	Bell button	5	1	84
62034	PROTACT 371 NI	Bell button	5	1	84
62045	PROTACT 210 AL	Bell button	5	1	84
62054	PROTACT 260 CR	Bell button	5	1	84
62060	PROTACT 550 VA	Bell button	5	1	85
62061	PROTACT 510 AL	Bell button	5	1	85
62070	PROTACT 650 VA	Bell button	5	1	85
63022	PROTACT 101 LED	Bell button	3	2	86
63032	PROTACT 100 LED	Bell button	3	2	86
63042	PROTACT 102 LED	Bell button	3	2	86
63052	PROTACT 105 LED	Bell button	3	2	86
63222	PROTACT 210 LED	Bell button LED-ring white	1	2	86

LIST OF TYPES

Order no.	Type	Description	PU	DC	Page
63232	PROTACT 220 LED	Bell button LED-ring blue	1	2	86
63242	PROTACT 230 LED	Bell button LED-ring white	1	2	86
63252	PROTACT 240 LED	Bell button LED-ring blue	1	2	86
64025	KKO 5050	Bell button	10	1	95
64032	KKO 2001 WS/WS	Bell button Golf	10	1	95
64033	KKO 2018	Bell button	10	1	88
64034	KKO 2019	Bell button	10	1	88
64035	KKO 2005	Bell button	10	1	94
64036	KKO 2005 W	Bell button	10	1	94
64063	KKO 3736A	Bell button pendant	10	1	94
64070	KKOL 2001 WS/T	Bell button Fashion	1	1	94
64085	KKO 2002 ws	Bell button	1	1	94
64086	KKO 2002 sw	Bell button	1	1	94
64090	KKO 2001 WS/WS	Bell button Golf	1	1	95
64114	KKO 152B	sliding contact	1	1	98
64131	KS 2070 MS-GL	Contact-shell	1	1	88
64132	KS 2071 MS-AGL	Contact-shell	1	1	88
64141	KS 2074 WS	Contact-shell	1	1	88
64143	KS 2075	Contact-shell	1	1	88
64144	KS 2076	Contact-shell	1	1	88
64145	KS 2077 WS SI	Contact-shell	1	1	88
64151	TORK 2060	Gate contact	1	1	87
93011	TO 5300	Door opener	1	1	98
93012	TO 5110	Door opener	1	1	91
93013	TO 5111	Door opener	1	1	98
93014	TO 5112	Door opener	1	1	98
93015	TO 5113	Door opener	1	1	98
93021	TO 5600	Box-type door opener	1	1	99
93031	TO 5200	Chain pull door opener	1	1	98
93061	TO 5134	No-load current door opener	1	1	99
93071	TO 5110 E	Door opener	1	1	99
93081	TO 5400	Door opener	1	1	98
93082	TO 5411	Door opener	1	1	99
93083	TO 5412	Door opener	1	1	98
93084	TO 5413	Door opener	1	1	98
93090	TO 5900-L	Door opener	1	1	98
93091	TO 5900-R	Door opener	1	1	98
93098	TO WSB DIN L	Angled striking panel	1	1	99
93099	TO WSB DIN R	Angled striking plate	1	1	98
93114	TO 5116	Door opener	1	1	99
94022	TA 220d	Staircase light time switch	1	1	79
94500	McGuard PM-APws	Presence detector wall mount	1	2	71
94501	McGuard PM-EINBws	Presence detector flush mount	1	2	71
94503	McGuard PM-AP HR	Motion detector	1	2	71
94504	McGuard BM DAV	Motion detector ceiling surface mounted	1	2	71

LIST OF TYPES

Order no.	Type	Description	PU	DC	Page
94505	McGuard DEB	Motion detector for ceiling installation	1	2	71
94506	McGuard DE PB	Motion detector for ceiling installation	1	2	71
94508	McGuard IR-11	McGuard IR-Control	1	2	72
94520	McGuard HF EB	Motion detector lamp installation	1	2	72
94522	McGuard UP	Motion detector flush-mounting	1	2	72
94530	McGuard professional BM120ws	Motion Detector professional 120	1	2	70
94531	McGuard professional BM240ws	Motion Detector professional 240	1	2	70
94532	McGuard professional BM360ws	Motion Detector professional 360	1	2	70
94533	McGuard professional BM120sw	Motion Detector professional 120	1	2	70
94534	McGuard professional BM240sw	Motion Detector professional 240	1	2	70
94535	McGuard professional BM360sw	Motion Detector professional 360	1	2	70
94536	McGuard professional BM240iws	Motion Detector professional 240 i	1	2	70
94537	McGuard professional BM360iws	Motion Detector professional 360 i	1	2	70
94538	McGuard IR FB	Remote control (IR-B24)	1	2	70
94555	McGuard LED RL692JH ws	LED floodlight incl PIR detector	1	2	73
94559	McGuard LED RL692JV ws	LED floodlight incl PIR detector	1	2	73
94560	McGuard Mantis	LED floodlight incl PIR detector	1	2	73
98002	RÄHMCHEN 500-2 EV1	Small frame	10	3	100
98005	RÄHMCHEN 500-2 R14	Small frame	10	3	77
98009	RÄHMCHEN 500-1 EV1	Small frame	10	3	100
98010	RÄHMCHEN 500-1 V2A	Small frame	5	3	100
98012	RÄHMCHEN 500-1 R14	Small frame	10	3	100
98013	GRAV.SCH.500-9 EV1	Engraving plate	10	3	100
98020	BULB 1327	Replacement bulb	10	2	100
98023	RÄHMCHEN 600 GRAU	Small frame	10	3	100
98025	RÄHMCHEN 600 SCH	Small frame	10	3	100
98032	GRAV.SCH.900 EV1	Engraving plate	5	3	100
98035	GRAV.SCH.500-8 EV1	Engraving plate	10	3	100
98054	RÄHMCHEN 600 WS	Small frame	10	3	100
98056	NSH LED 100 WS	LED name plate	1	1	100
98061	GS 500-10 EV1	Engraving plate	10	3	100
98062	GS 500-10 V2A	Engraving plate	5	3	100
98063	GS 500-10 GO	Engraving plate	5	3	100
98064	GS 500-10 R14	Engraving plate	5	3	100
98065	NSH LED 100 BL	LED name plate	1	1	100
98191	Glühlampe Lux	Replacement bulb	10	3	100

International

AUSTRIA

SIBLIK ELEKTRIK Ges.m.b.H & Co KG
Abteilung Vertrieb
Murbangasse 6
A-1108 Wien
Phone: +43 (0)1 68 00 6 - 131
Fax: +43 (0)1 68 00 6 - 21
www.siblik.com
wien@siblik.com

AUSTRALIA

Energy Conversation Solutions Pty Ltd.
103 Lewis Road
Unit 9
3180 Knoxfield Victoria
Phone: +613 9801 4838
Fax: +613 9801 2450
www.ecs.net.au
sales@ecs.net.au

BELGIUM

Vander Elst SA
Gerselarendries 9
B 1850 Grimbergen
Phone: +32 (0)2 751 42 59
Fax: +32 (0)2 242 26 24
www.vanderelst-electric.be
info@vanderelst-electric.be

BULGARIA

POPP EOOD
Obedinena Str.
Shiakovtzi Area
2233 Kostinbrod
Phone: +359 (0)700 44 000
Fax: +359 (0)700 44 045
www.popp.bg

CZECH REPUBLIC

URMET s.r.o.
Vetрна 102
41742 Krupka-Nove Modlany
Phone: +420417532204
Fax: +420417535095
www.urmetdomus.cz
info@urmet.cz

DENMARK

Urmet AS
Banegårdsgade 14
8300 Odder
Denmark
Phone: +45 23 03 9 20
www.urmet.dk
post@urmet.dk

FINLAND

OY T. STENBACKA AB
Emalikatu 2B
04440 Järvenpää
Phone: +358 207 432 320
Fax: +358 207 432 349
www.stenbacka.fi
stenbacka.info@stenbacka.fi

FRANCE

Urmet France
94 Rue de la Belle Etoile
95941 Roissy Charles de Gaulle
Phone: +33 1 55 85 84 00
Fax: +33 1 41 84 68 28
www.urmet.fr

GREAT BRITAIN

Urmet UK
480 Urban Hive, Skyline 120
Avenue West, Great Notley
Essex CM 77 7AA3
Phone: +44 1371 871585
Fax: +44 1371 871584
www.urmet.co.uk
sales@urmet.co.uk

GREECE

Aliberti s.a.
22nd km Lavriou ave.,
P.O.B 115, Post code 194 00 Koropi
Phone: +30 210 6626 384-5
Fax: +30 210 6626 034
www.aliberti.gr
aliberti@aliberti.gr

HUNGARY

Urmet Domus Hungaria Kft.
Liliom u. 39
1094 Budapest
Phone: +36 (0)1 216-6130
Fax: +36 (0)1 476-0876
www.urmet.hu
urmetdomus@t-online.hu

IRELAND

Connor Margetson, Marlin Enterprises
10 Vesey Place
Monkstown, Dun Laoghaire
Co. Dublin, Ireland
Phone: +353-1-280-7205
Fax: +353-1-280-7776
Mobile: +353-87-260-6297
connor@marlinent.iol.ie

NETHERLANDS

Hemmink B.V.
Ampèrestraat 24 – 28
8013 PV Zwolle
Phone: +31-384698200
Fax: +31-384698210
www.hemmink.nl
info@hemmink.nl

NEW ZEALAND

Mardag Holdings Ltd.
PO Box 51184 Tawa
Wellington
Phone: +64 42 37 89 12
Fax: +64 42 37 45 59
marcus@mardag.co.nz

NORWAY

Urmet AS
Vesterveien 193D
4817 His
Norway
Phone: +45 86 13 00 00
www.urmet.no
post@urmet.dk

PORTUGAL

DNL – Duarte Neves, L.da
Rua D do Núcleo Empresarial da Venda
do Pinheiro
Quinta dos Estrangeiros, PAVILHÃO 78
2665-601 VENDA DO PINHEIRO
Phone: +351 219 668 100
Fax: +351 219 862 817
www.duarteneves.pt
info@duarteneves.pt

SLOVAKIA

URMET s.r.o.
Roznavská 1 (R1 Centrum)
83104 Bratislava
Phone: +421253631142
Fax: +421253631144
www.urmet.sk
info@urmetdomus.sk

SINGAPORE

Fung Yip Electrical (S) Pte Ltd
119, Ganting Lane #05-04
349570 Singapur
Phone: +65 6396 3133
Fax: +65 6846 9958
www.fungyip.com
tanbengkoon@fungyip.com.sg

SWITZERLAND

Ferratec AG
Grossmarktstrasse 19
8964 Rudolfstetten
Phone: +41 (0)56 649 21 21
Fax: +41 (0)56 649 21 41
www.ferratec.ch
info@ferratec.ch

We are looking for further distributors.
If you are interested, please contact the
export department at GROTHE.



Adobe Stock Copyrights: crowd3 © k-xperience, house at night © leslie derek sanders, Hochhauskomplex © Aamon, storm © olly, Fans und Scheinwerfer © G.Light, Konzertsonnen © G.Light, helicopter © graham tomlin, Rewe © Werner Weber, lighthouse © victor zastol'skiy, Welle © howie, Cheering crowd at concert, musicians on the stage © DWP, © vectorlart, © karandaev, Coffee table in a garden © konradbak, Cheerful couple inviting people © jackfrog, Kölner Rheinauhafen mit Kranbauten © Omm-on-tour, New homes © Zoe, Luxury modern Living room © 3DarcaStudio, Modern living room in townhouse © 2mmedia, Modern scandinavian living room © FollowTheFlow, Modern interior of apartment © Vadim Andrushchenko, Haus Standard weiß mit Garage © KB3, Family spending time together at home © Monkey Business, Modern home facade with entrance © Wilm Ihlenfeld, Modern scandinavian living room © FollowTheFlow, crowd3 © k-xperience, house at night © leslie derek sanders, Hochhauskomplex © Aamon, storm © olly, Fans und Scheinwerfer © G.Light, Konzertsonnen © G.Light, helicopter © graham tomlin, Rewe © Werner Weber, lighthouse © victor zastol'skiy, Welle © howie, Cheering crowd at concert, musicians on the stage © DWP • **DREAMSTIME BILDDATENBANK** Copyrights: Planet Earth Space View © Gregor Kervina, Space © Doffdog, Adraga beach at sunset © Luisafonso, Golden Gate Bridge © Henrik Andersen, Red concert hall © Aleksey Nikonchuk, Close-up portrait of red-head lovely girl © Sokolovsky, Truck driving at dusk/motion blur © Mikael Damkier, Time Square © Tinnaporn Sathapornnanont © Lassedignen Smartphone, Cover © DavidArts • **unsplash** Copyrights: Raum S. 66 © patricia-rieder, Raum S.148 © patricia-rieder; Planet Earth Space View © Gregor Kervina, Space © Doffdog, Adraga beach at sunset © Luisafonso, Golden Gate Bridge © Henrik Andersen, Red concert hall © Aleksey Nikonchuk, Close-up portrait of red-head lovely girl © Sokolovsky, Truck driving at dusk/motion blur © Mikael Damkier, Time Square © Tinnaporn Sathapornnanont. • **Shutterstock** Copyrights: Stylish living room © New Africa • **I-Stock** Copyrights: Apartment houses © querbeet • **Digital Photographie and Composing**: Jürgen Helbig. Fotografie. Hürth. www.helbig-fotografie.de