

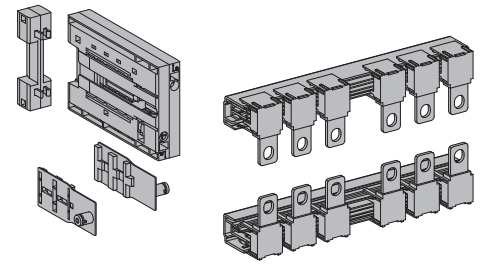

NNZ4813501-02

**Mechanical Interlock and Coupling Bars**  
**Interverrouillage mécanique et jeux de connexions puissance**  
**Enclavamiento mecánico y barras de acoplamiento**  
**Mechanische Verriegelung und Koppelstangen**  
**Barre di accoppiamento e interblocco meccanico**  
**Trava de segurança eletrônica e barras de acoplamento**  
**Механическая блокировка и соединительные штанги**  
**机械联锁和端子连接排**



## ⚠️ DANGER / DANGER / PELIGRO / GEFAHR / PERICOLO / PERIGO / ОПАСНОСТЬ / 危险

### HAZARD OF ELECTRIC SHOCK, EXPLOSION OR ARC FLASH

● Read and understand this document and the installation guide before installing, operating, or maintaining your TeSys Giga product.  
 ● Apply appropriate personal protective equipment (PPE) and follow safe electrical work practices. See NFPA 70E, CSA Z462, NOM-029-STPS or local equivalent.  
 ● This equipment must only be installed and serviced by qualified electrical personnel.  
 ● Turn off all power supplying this equipment before working on or in this equipment.  
 ● Use only the specified voltage when operating this equipment and any associated products.  
 ● Power line circuits must be wired and protected in compliance with local and national regulatory requirements.  
 ● Beware of potential hazards, and carefully inspect the work area for tools and objects that may have been left inside the equipment.  
**Failure to follow these instructions will result in death or serious injury.**

### RISQUE D'ÉLECTROCUTION, D'EXPLOSION OU D'ECLAIR D'ARCS ÉLECTRIQUE

● Veuillez lire attentivement ce document ainsi que le guide d'installation avant d'installer, faire fonctionner ou d'effectuer une maintenance sur votre produit TeSys Giga.  
 ● Portez un équipement de protection individuel (EPI) adapté et respectez les consignes de sécurité électrique courantes. Reportez-vous aux normes NFPA 70E, CSA Z462, NOM-029-STPS ou aux codes locaux en vigueur.  
 ● Ce dispositif doit impérativement être installé et entretenu par un électricien qualifié.  
 ● Coupez toutes les alimentations de l'équipement avant de travailler sur ou dans cet équipement.  
 ● Utilisez uniquement la tension indiquée pour faire fonctionner cet équipement et les produits associés.  
 ● Les circuits électriques doivent être câblés et protégés conformément aux exigences réglementaires locales et nationales.  
 ● Faites attention aux dangers potentiels et inspectez attentivement la zone de travail pour vous assurer qu'aucun outil ou objet n'est resté à l'intérieur de l'équipement.  
**Si ces directives ne sont pas respectées, cela entraînera la mort ou des blessures graves.**

### PELIGRO DE DESCARGA ELÉCTRICA, EXPLOSIÓN O ARCO ELÉCTRICO

● Lea y comprenda este documento y la guía de instalación antes de instalar, manejar o realizar el mantenimiento de su producto TeSys Giga.  
 ● Utilice equipo de protección personal (EPP) apropiado y siga las prácticas de seguridad eléctricas establecidas. Consulte las normas NFPA 70E, CSA Z462, NOM-029-STPS u otros códigos locales correspondientes.  
 ● Solamente personal eléctrico calificado deberá instalar y prestar servicio de mantenimiento a este equipo.  
 ● Desconecte todas las fuentes de alimentación del equipo antes de realizar cualquier trabajo dentro o fuera de él.  
 ● Aplique solo la tensión especificada cuando utilice este equipo y los productos asociados.  
 ● Los circuitos de la línea eléctrica deben estar cableados y protegidos de acuerdo con los requisitos regulatorios locales y nacionales.  
 ● Tenga cuidado con los riesgos potenciales, e inspeccione cuidadosamente la zona de trabajo para comprobar si han quedado herramientas y objetos dentro del equipo.  
**El incumplimiento de estas instrucciones provocará lesiones graves o incluso la muerte.**

### GEFAHR VON ELEKTRISCHEM SCHLAG, EXPLOSION ODER LICHTBOGEN

● Lesen Sie sich dieses Dokument sowie die Installationsanleitung bitte sorgfältig durch, bevor Sie Ihr TeSys Giga-Produkt installieren, bedienen oder warten.  
 ● Tragen Sie persönliche Schutzausrüstung (PSA) und befolgen Sie sichere Verfahren im Umgang mit Elektrogeräten. Siehe NFPA 70E, CSA Z462, NOM-029-STPS oder lokale Entsprechung.  
 ● Dieses Gerät darf nur von qualifiziertem Elektrofachpersonal installiert und gewartet werden.  
 ● Schalten Sie jegliche Stromversorgungen ab, bevor Sie Arbeiten am oder im Gerät vornehmen.  
 ● Betreiben Sie dieses Gerät und jegliche zugehörigen Produkte nur mit der angegebenen Spannung.  
 ● Stromkreise müssen gemäß den örtlichen und nationalen Vorgaben verkabelt und geschützt sein.  
 ● Beachten Sie potenzielle Gefahren, und überprüfen Sie den Arbeitsbereich auf Werkzeuge und andere Gegenstände, die sich möglicherweise noch in der Anlage befinden.  
**Die Nichtbeachtung dieser Anweisungen führt zu Tod oder schweren Verletzungen.**

### RISCHIO DI FOLGORAZIONE, ESPLOSIONI O ARCO ELETTRICO

● Leggere attentamente il presente documento e la guida di installazione prima di installare, utilizzare o sottoporre a manutenzione il prodotto TeSys Giga.  
 ● Utilizzare dispositivi di protezione individuale (DPI) idonei e adottare misure di sicurezza adeguate per lavori elettrici. Vedere le normative NFPA 70E, CSA Z462, NOM-029-STPS o le norme equivalenti nel paese di installazione.  
 ● Questo dispositivo deve essere installato e mantenuto solo da personale elettrotecnico qualificato.  
 ● Interrompere l'alimentazione elettrica al dispositivo prima di qualsiasi intervento su di esso o al suo interno.  
 ● Utilizzare quest'apparecchiatura e tutti i prodotti collegati solo alla tensione specificata.  
 ● I circuiti di alimentazione devono essere cablati e protetti conformemente ai requisiti normativi locali e nazionali.  
 ● Prestare attenzione a potenziali pericoli e ispezionare con attenzione l'area di lavoro per assicurarsi di non aver dimenticato utensili o altri oggetti all'interno dell'apparecchiatura.  
**Il mancato rispetto di queste istruzioni provocherà morte o gravi infortuni.**

### RISCO DE ELECTROCUSSÃO, DE EXPLOÇÃO, OU DE ARCO ELÉCTRICO

● Leia e compreenda este documento e o guia de instalação antes de instalar, operar ou fazer a manutenção seu produto TeSys Giga.  
 ● Utilize equipamento de proteção pessoal (PPE) e siga os métodos de segurança elétrica. Consulte NFPA 70E, CSA Z462, NOM-029-STPS ou o equivalente local.  
 ● A instalação e a manutenção deste equipamento só devem ser realizadas por eletricitistas qualificados.  
 ● Desligue a fonte de alimentação antes de trabalhar com este ou neste equipamento.  
 ● Use somente a voltagem especificada ao operar este equipamento e qualquer produto associado.  
 ● Os circuitos elétricos têm de ser instalados e protegidos em conformidade com os requisitos dos regulamentos locais e nacionais aplicáveis.  
 ● Esteja atento a potenciais perigos e inspeção cuidadosamente a área de trabalho para se assegurar que não foram deixadas ferramentas e objetos no interior do equipamento.  
**A não observância destas instruções resultará em morte, ou ferimentos graves.**

### Опасность поражения электрическим током, взрыва или возникновения дуги

● Перед началом монтажа, эксплуатации или технического обслуживания изделия TeSys Giga прочитайте и усвойте содержание данного документа и руководства по установке.  
 ● Используйте подходящие средства индивидуальной защиты (СИЗ) и соблюдайте технику безопасности при электротехнических работах. См. NFPA 70E, CSA Z462, NOM-029-STPS или местный эквивалентный стандарт.  
 ● Электрическое оборудование должно устанавливаться и обслуживаться только квалифицированным персоналом.  
 ● Выключите подачу питания к данному оборудованию перед работой на оборудовании или внутри него.  
 ● При эксплуатации данного оборудования и любых связанных с ним устройств используйте только указанное напряжение.  
 ● Цепи электропитания должны быть подключены и защищены в соответствии с местными и государственными нормативными требованиями.  
 ● Избегайте потенциальных опасностей, внимательно осмотрите рабочую область на наличие инструментов и предметов, которые могли остаться внутри оборудования.  
**Несоблюдение этих инструкций приведет к смерти или серьезной травме.**

### 电击、爆炸或弧闪的危险

● 安装、操作或维护 TeSys Giga 产品之前，请阅读并理解本文档和安装指南。  
 ● 采用适当的个人防护设备 (PPE) 并遵循电气作业安全守则。请参阅 NFPA 70E, CSA Z462, NOM-029-STPS 或当地对应的标准。  
 ● 只能由具备资质的电工来安装和维修本设备。  
 ● 在本设备上或设备内工作前，必须关闭本设备的所有电源。  
 ● 仅使用指定电压操作本设备及任何关联产品。  
 ● 电源线路的接线和保护必须符合本地和国家规范要求。  
 ● 注意潜在危险，仔细检查作业区，以免将工具和物件遗忘在设备内部。  
**不遵循上述说明将导致人员伤亡。**

<p><b>PLEASE NOTE</b></p> <ul style="list-style-type: none"> <li>Electrical equipment should be installed, operated, serviced, and maintained only by qualified personnel.</li> <li>No responsibility is assumed by Schneider Electric for any consequences arising out of the use of this material.</li> </ul>	<p><b>REMARQUE IMPORTANTE</b></p> <ul style="list-style-type: none"> <li>Seul un personnel qualifié doit effectuer l'installation, l'utilisation, l'entretien et la maintenance du matériel électrique.</li> <li>Schneider Electric n'assume aucune responsabilité des conséquences éventuelles découlant de l'utilisation de ce matériel.</li> </ul>	<p><b>TENGA EN CUENTA</b></p> <ul style="list-style-type: none"> <li>Solamente el personal calificado deberá instalar, hacer funcionar y prestar servicios de mantenimiento al equipo eléctrico.</li> <li>Schneider Electric no asume responsabilidad alguna por las consecuencias emergentes de la utilización de este material.</li> </ul>	<p><b>BITTE BEACHTEN</b></p> <ul style="list-style-type: none"> <li>Elektrische Geräte sollte stets von qualifiziertem Personal installiert, betrieben und gewartet werden.</li> <li>Schneider Electric haftet nicht für Schäden, die durch die Verwendung dieses Materials entstehen.</li> </ul>
<p><b>NOTA</b></p> <ul style="list-style-type: none"> <li>L'installazione, l'utilizzo e la manutenzione di dispositivi elettrici deve essere affidata esclusivamente a personale qualificato.</li> <li>Schneider Electric non si assume alcuna responsabilità relativa a conseguenze derivanti dall'uso del presente materiale.</li> </ul>	<p><b>NOTA</b></p> <ul style="list-style-type: none"> <li>O equipamento elétrico deve ser instalado, operado, reparado e mantido exclusivamente por pessoal qualificado.</li> <li>A Schneider Electric não se responsabiliza por quaisquer consequências derivantes da utilização deste material.</li> </ul>	<p><b>ОБРАТИТЕ ВНИМАНИЕ</b></p> <ul style="list-style-type: none"> <li>Электрическое оборудование должно устанавливаться, использоваться, ремонтироваться и обслуживаться только квалифицированным персоналом.</li> <li>Компания Schneider Electric не несет ответственности за последствия, вызванные использованием данного материала.</li> </ul>	<p><b>请注意</b></p> <ul style="list-style-type: none"> <li>电气设备应仅由经过认证的技术人员进行安装、操作、维护和维修。</li> <li>施耐德电气对因使用本说明而产生的任何后果不承担责任。</li> </ul>

**⚠ WARNING / AVERTISSEMENT / ADVERTENCIA / WARNUNG / AVVERTIMENTO / ATENÇÃO / ПРЕДУПРЕЖДЕНИЕ / 警告**

<p><b>HAZARD OF FLASHOVER BETWEEN PHASES</b></p> <p>Phase separators must be installed if the network voltage is greater than or equal to 690 V~.</p> <p><b>Failure to follow these instructions can result in death, serious injury, or equipment damage.</b></p>	<p><b>RISQUE D'ARC ÉLECTRIQUE ENTRE PHASES</b></p> <p>Des séparateurs de phases doivent être installés si la tension réseau est supérieure ou égale à 690 V~.</p> <p><b>Si ces directives ne sont pas respectées, cela peut entraîner la mort ou des blessures graves ou des dommages matériels.</b></p>	<p><b>PELIGRO DE SALTO DE ARCO ENTRE FASES</b></p> <p>Se deben instalar separadores de fases si la tensión de red es mayor o igual que 690 V~.</p> <p><b>El incumplimiento de estas instrucciones puede causar la muerte, lesiones serias o daño al equipo.</b></p>	<p><b>GEFAHR EINES LICHTBOGENS ZWISCHEN PHASEN</b></p> <p>Bei einer Netzspannung größer oder gleich 690 V~ müssen Phasentrenner installiert werden.</p> <p><b>Die Nichtbeachtung dieser Anweisungen kann Tod, schwere Verletzungen oder Sachschäden zur Folge haben.</b></p>
<p><b>RISCHIO DI SCARICHE ELETTRICHE TRA LE FASI</b></p> <p>Se la tensione di rete è superiore o uguale a 690 V~, è necessario installare i separatori di fase.</p> <p><b>Il mancato rispetto di queste istruzioni può provocare morte, gravi infortuni o danni alle apparecchiature.</b></p>	<p><b>PERIGO DE FLASHOVER ENTRE FASES</b></p> <p>Os separadores de fase devem ser instalados se a tensão da rede for maior ou igual a 690 V~.</p> <p><b>A não observância destas instruções pode provocar a morte, ferimentos graves, ou danos no equipamento.</b></p>	<p><b>ОПАСНОСТЬ ВСПЫШКИ МЕЖДУ ФАЗАМИ</b></p> <p>Если напряжение в сети равно 690 В переменного тока или выше, необходимо установить межфазные перегородки.</p> <p><b>Несоблюдение этих инструкций может привести к смерти, серьезной травме или повреждению оборудования.п.</b></p>	<p><b>相间闪络风险</b></p> <p>如果网络电压大于或等于 690 V~, 则必须安装相间隔板。</p> <p><b>不遵循上述说明可能导致人员伤亡或设备损坏。</b></p>

**⚠ WARNING / AVERTISSEMENT / ADVERTENCIA / WARNUNG / AVVERTIMENTO / ATENÇÃO / ПРЕДУПРЕЖДЕНИЕ / 警告**

<p><b>HAZARD OF FIRE</b></p> <ul style="list-style-type: none"> <li>Use only specified wiring cross-section with the equipment and comply with the specified wiring requirements.</li> <li>Tighten the connections to the specified torque values.</li> </ul> <p><b>Failure to follow these instructions can result in death, serious injury, or equipment damage.</b></p>	<p><b>RISQUE D'INCENDIE</b></p> <ul style="list-style-type: none"> <li>Utilisez exclusivement des conducteurs électriques de la section spécifiée pour cet équipement et respectez les exigences spécifiées en matière de câblage.</li> <li>Serrez les connexions à la valeur de couple de serrage spécifiée.</li> </ul> <p><b>Si ces directives ne sont pas respectées, cela peut entraîner la mort ou des blessures graves ou des dommages matériels.</b></p>	<p><b>RIESGO DE INCENDIO</b></p> <ul style="list-style-type: none"> <li>Utilice con el equipo únicamente la sección transversal de cableado especificada y cumpla los requisitos de cableado especificados.</li> <li>Apriete las conexiones con los valores de par de apriete especificados.</li> </ul> <p><b>El incumplimiento de estas instrucciones puede causar la muerte, lesiones serias o daño al equipo.</b></p>	<p><b>BRANDGEFAHR</b></p> <ul style="list-style-type: none"> <li>Verwenden Sie mit dem Gerät ausschließlich die angegebenen Drahtstärken und beachten Sie die genannten Anforderungen an die Verdrahtung.</li> <li>Ziehen Sie die Steckverbinder mit den angegebenen Anzugsmomenten fest.</li> </ul> <p><b>Die Nichtbeachtung dieser Anweisungen kann Tod, schwere Verletzungen oder Sachschäden zur Folge haben.</b></p>
<p><b>RISCHIO DI INCENDIO</b></p> <ul style="list-style-type: none"> <li>Utilizzare con l'apparecchiatura solo cavi con la sezione specificata e conformi ai requisiti di cablaggio specificati.</li> <li>Serrare le connessioni ai valori di coppia specificati.</li> </ul> <p><b>Il mancato rispetto di queste istruzioni può provocare morte, gravi infortuni o danni alle apparecchiature.</b></p>	<p><b>PERIGO DE INCÊNDIO</b></p> <ul style="list-style-type: none"> <li>Use apenas a seção transversal de fiação especificada com o equipamento e cumpra os requisitos de fiação especificados.</li> <li>Aperte as conexões com os valores de torque especificados.</li> </ul> <p><b>A não observância destas instruções pode provocar a morte, ferimentos graves, ou danos no equipamento.</b></p>	<p><b>РИСК ВОЗНИКНОВЕНИЯ ПОЖАРА</b></p> <ul style="list-style-type: none"> <li>Используйте с оборудованием только провода с указанной площадью поперечного сечения и соблюдайте указанные требования к проводке.</li> <li>Резьбовые соединения затягивайте с указанными значениями крутящего момента.</li> </ul> <p><b>Несоблюдение этих инструкций может привести к смерти, серьезной травме или повреждению оборудования.</b></p>	<p><b>火灾危险</b></p> <ul style="list-style-type: none"> <li>仅为设备使用具有指定线规的接线，并遵守接线要求。</li> <li>以指定的扭矩值紧固接头。</li> </ul> <p><b>不遵循上述说明可能导致人员伤亡或设备损坏。</b></p>

<p><b>⚠ WARNING:</b> Cancer and Reproductive Harm. For more information go to <a href="http://www.P65Warnings.ca.gov">www.P65Warnings.ca.gov</a>.</p>	<p><b>⚠ AVERTISSEMENT:</b> Cancer et effet nocif sur la reproduction. Pour de plus amples informations, prière de consulter <a href="http://www.P65Warnings.ca.gov">www.P65Warnings.ca.gov</a>.</p>	<p><b>⚠ ADVERTENCIA:</b> Cáncer y Daño Reproductivo. Para mayor información, visite <a href="http://www.P65Warnings.ca.gov">www.P65Warnings.ca.gov</a>.</p>	<p><b>⚠ 警告:</b> 癌症及生殖系统损害。欲了解更多信息，请查阅 <a href="http://www.P65Warnings.ca.gov">www.P65Warnings.ca.gov</a>。</p>
---	---	---	---

**Documentation / Documentación / Documentación / Unterlagen / Documentazione / Documentação / Документация / 文档**

<p><a href="http://www.se.com">www.se.com</a></p> 	<p>(en) DOCA0189EN – TeSys Giga Series - Installation Guide</p> <p>(fr) DOCA0189FR – TeSys Giga Series - Guide d'installation</p> <p>(es) DOCA0189ES – TeSys Giga Series - Guía de instalación</p> <p>(de) DOCA0189DE – TeSys Giga Series - Installationsanleitung</p>	<p>(it) DOCA0189IT – TeSys Giga Series - Guida di installazione</p> <p>(pt) DOCA0189PT – TeSys Giga Series - Guia de instalação</p> <p>(ru) DOCA0189RU – TeSys Giga Series - Руководство по установке</p> <p>(zh) DOCA0189ZH – TeSys Giga Series - 安装指南</p>
<p><a href="http://www.se.com/cn">www.se.com/cn</a></p> 	<p>(en) DOCA0191EN – TeSys Giga Series China - Installation Guide</p> <p>(zh) DOCA0191ZH – TeSys Giga Series 中国 - 安装指南</p>	

**NOTICE / AVIS / AVISO / HINWEIS / AVVISO / AVISO / УВЕДОМЛЕНИЕ / 注意**

**INCORRECT CONTACTOR POSITIONS**  
Respect the dimensions given to fix the contactors.  
**Failure to follow these instructions will result in the impossibility to use the interlock and the coupling bars.**

**POSITIONS DE CONTACTEUR INCORRECTES**  
Respectez les dimensions indiquées pour fixer les contacteurs.  
**Le non-respect de ces instructions rendra impossible l'utilisation du verrouillage et des barres de couplage.**

**POSICIONES DE CONTACTOR INCORRECTAS**  
Respete las dimensiones indicadas para fijar los contactores.  
**No seguir estas instrucciones impedirá usar el enclavamiento y las barras de acoplamiento.**

**FALSCH E POSITION DER SCHÜTZE**  
Beachten Sie bei der Befestigung der Schütze die angegebenen Abmessungen.  
**Die Nichtbeachtung dieser Anweisungen hat zur Folge, dass Verriegelung und Koppelstangen nicht verwendet werden können.**

**POSIZIONI ERRATE DEL CONTATTORE**  
Rispettare le dimensioni indicate per fissare i contattori.  
**La mancata osservanza delle presenti istruzioni determina l'impossibilità di utilizzare l'interblocco e le barre di accoppiamento.**

**POSIÇÕES INCORRETAS DO CONTATOR**  
Respeite as dimensões dadas para corrigir os contactores.  
**A falha em seguir essas instruções resultará na impossibilidade de usar a trava de segurança e as barras de acoplamento.**

**НЕПРАВИЛЬНОЕ ПОЛОЖЕНИЕ КОНТАКТОРА**  
При креплении контакторов соблюдайте указанные размеры.  
**Несоблюдение данных инструкций приведет к невозможности использования блокировки и соединительных штанг.**

**不正确的接触器位置**  
按要求预留一定空间, 以便维修接触器。  
**不遵守这些说明将导致无法使用联锁和联杆。**

**1 Contactor Installation for Changeover and Reverser / Installation de contacteurs-inverseurs / Instalación del contactor para conmutación e inversión / Installation der Wendeschütze (Quellenumschalter und Motorschalter) / Installazione contattore per commutazione e invertitore / Instalação do contator para troca e reversão / Установка контактора для инверсии источника питания и переключателя направления вращения двигателя / 电源转换及正反转应用的接触器安装**

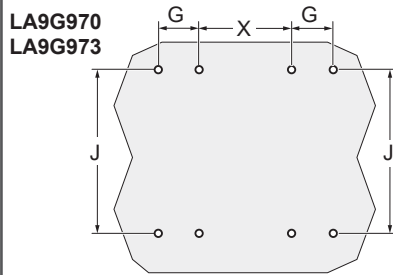

**i** LC1G205-620C are 3-pole contactors only.  
LC1G205-620C只提供3P接触器。

mm in.	LA9G970				LA9G973	
	LC1G115-225 LC1G205-245C		LC1G265-500 LC1G300-475C		LC1G630-800 LC1G620C	
	3P	4P	3P	4P	3P	4P
<b>G</b>	35 1.38	70 2.75	45 1.77	90 3.54	70 2.75	140 5.51
<b>J</b>	166 6.53	166 6.53	187 7.36	187 7.36	242 9.52	242 9.52
<b>X</b>	92.7 3.65	92.7 3.65	115 4.53	115 4.53	160 6.30	160 6.30

**2 Contactor Installation for Star-Delta / Installation de contacteurs étoile-triangle / Instalación del contactor para Star-Delta / Installation der Sterndreieckschütze / Installazione contattore per stella-triangolo / Instalação do contator para estrela-delta / Установка контактора для соединения звезда-треугольник / 星三角应用的接触器安装**

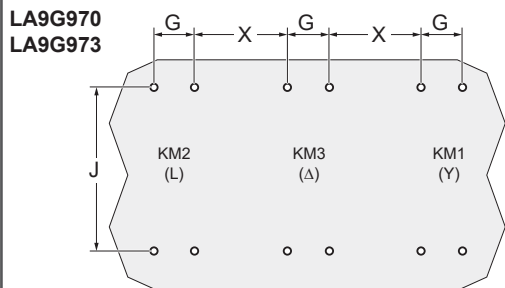

mm in.	LA9G970		LA9G973
	LC1G115-225 LC1G205-245C	LC1G265-500 LC1G300-475C	LC1G630-800 LC1G620C
	3P	3P	3P
<b>G</b>	35 1.38	45 1.77	70 2.75
<b>J</b>	166 6.53	187 7.36	242 9.52
<b>X</b>	92.7 3.65	115 4.53	160 6.29

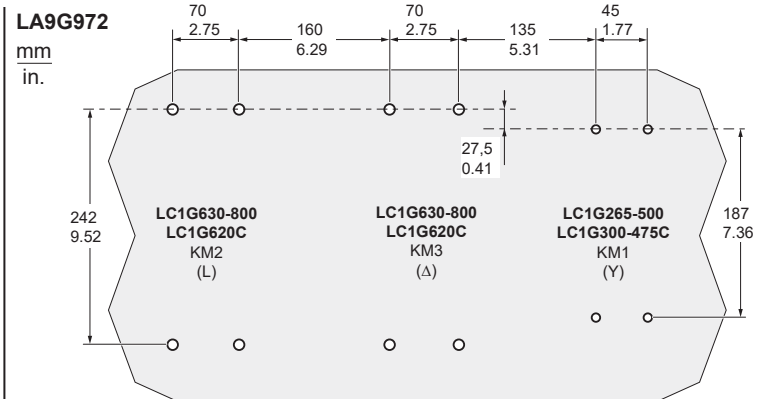
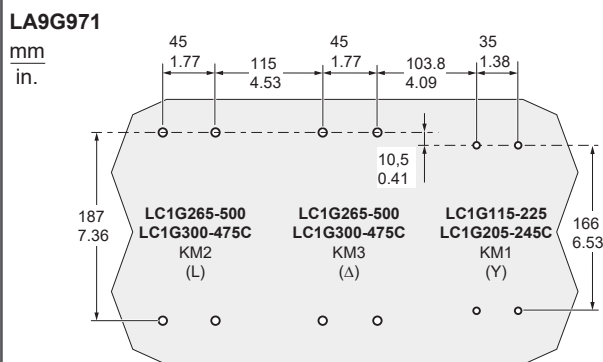

**en** To ease contactor mounting, drilling stencils JYT1902701 can be downloaded from the [www.se.com](http://www.se.com) website.

**fr** Pour faciliter le montage des contacteurs, des gabarits de perçage JYT1902701 peuvent être téléchargés sur le site [www.se.com](http://www.se.com).

**es** Para facilitar el montaje del contactor, se pueden descargar las plantillas de perforación JYT1902701 del sitio web de [www.se.com](http://www.se.com).

**de** Um die Montage der Schütze zu erleichtern, können Bohrschablonen JYT1902701 von der Website [www.se.com](http://www.se.com) heruntergeladen werden.

**it** Per facilitare il montaggio del contattore, è possibile scaricare i modelli di foratura JYT1902701 dal sito Web [www.se.com](http://www.se.com).

**pt** Para facilitar a montagem do contator, os moldes de perfuração JYT1902701 podem ser baixado do site [www.se.com](http://www.se.com).

**ru** Для облегчения монтажа контактора можно загрузить шаблоны для сверления JYT1902701 с веб-сайта [www.se.com](http://www.se.com).

**zh** 如要简化接触器安装, 可以从 [www.se.com](http://www.se.com) website 下载打孔模板 JYT1902701。



# 3

## LA9G97: Mechanical Interlock Installation / Installation de l'interverrouillage mécanique / Instalación del enclavamiento mecánico / Installation der mechanischen Verriegelung / Installazione interblocco meccanico / Instalação da trava de segurança mecânica / Установка механической блокировки / 机械联锁安装

mm  
in.

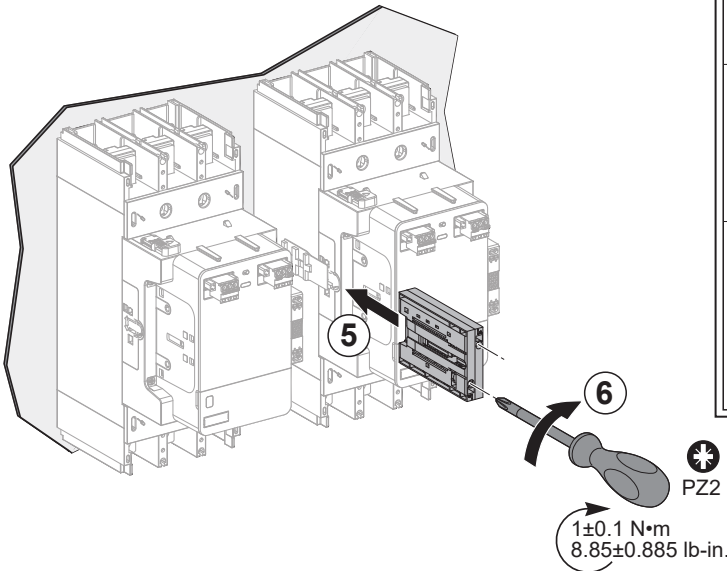
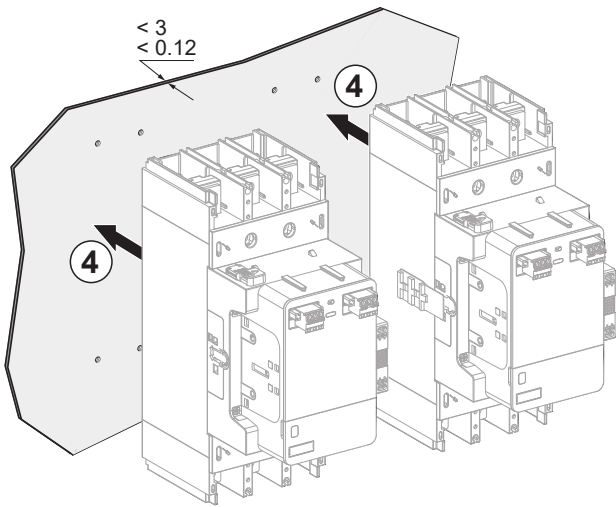
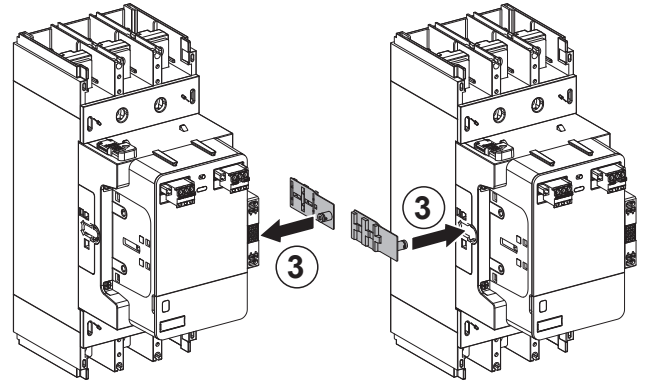
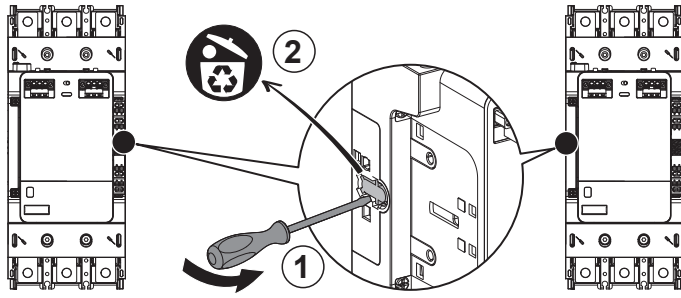

**i**

	LC1G115-225 LC1G205-245C	LC1G265-500 LC1G300-475C	LC1G630-800 LC1G620C
<b>LA9G970</b>			-
<b>LA9G971</b>			-
<b>LA9G972</b>	-		
<b>LA9G973</b>		-	

**en** To carry out installation of the LC1G contactor, consult the instruction sheet GDE2324401/NNZ9700201.

**fr** Pour effectuer l'installation du contacteur LC1G, consultez la notice GDE2324401/NNZ9700201.

**es** Para realizar la instalación del contactor LC1G, consulte la hoja de instrucciones GDE2324401/NNZ9700201.

**de** Anweisungen zur Installation der LC1G-Schütze finden Sie in der Kurzanleitung GDE2324401/NNZ9700201.



**it** Per effettuare l'installazione del contattore LC1G, consultare la scheda di istruzioni GDE2324401/NNZ9700201.

**pt** Para fazer a instalação do contator LC1G, consulte a folha de instruções GDE2324401/NNZ9700201.

**ru** Перед установкой контактора LC1G ознакомьтесь с буклетом с инструкциями GDE2324401/NNZ9700201.

**zh** 如要安装 LC1G 接触器, 请参阅说明书 GDE2324401/NNZ9700201.





# 4

## Auxiliary Contacts Installation / Installation des contacts auxiliaires / Instalación de los contactos auxiliares / Installation der Hilfskontakte / Installazione contatti ausiliari / Instalação dos contatos auxiliares / Установка вспомогательных контактов / 辅助触点安装

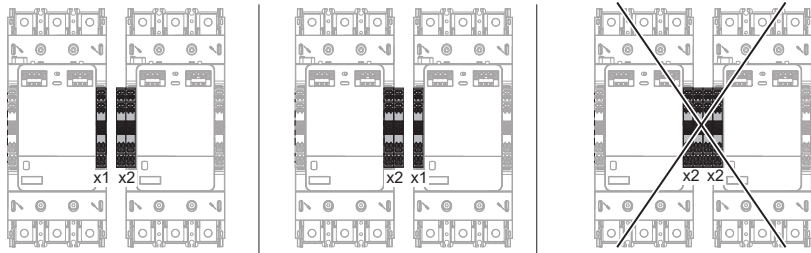

**en** ● Maximum 3 auxiliary contacts can be installed between 2 contactors with mechanical interlock.  
● To carry out installation of the auxiliary contact, consult the instruction sheet NNZ5266201/NNZ9700401.

**fr** ● Il est possible d'installer au maximum 3 contacts auxiliaires entre 2 contacteurs avec interverrouillage mécanique.  
● Pour effectuer l'installation du contact auxiliaire, consultez la notice NNZ5266201/NNZ9700401.

**es** ● Se puede instalar un máximo de 3 contactos auxiliares entre 2 contactores con enclavamiento mecánico.  
● Para realizar la instalación del contacto auxiliar, consulte la hoja de instrucciones NNZ5266201/NNZ9700401.

**de** ● Zwischen 2 Schützen mit mechanischer Verriegelung können maximal 3 Hilfskontakte installiert werden.  
● Anweisungen zur Installation der Hilfskontakte finden Sie in der Kurzanleitung NNZ5266201/NNZ9700401.



**it** ● È possibile installare fino a 3 contatti ausiliari tra 2 contattori con interblocco meccanico.  
● Per effettuare l'installazione del contatto ausiliario, consultare la scheda di istruzioni NNZ5266201/NNZ9700401.

**pt** ● No máximo, 3 contatos auxiliares podem ser instalados entre 2 contadores com trava de segurança mecânica.  
● Para fazer a instalação do contato auxiliar, consulte a folha de instruções NNZ5266201/NNZ9700401.

**ru** ● Между 2 контакторами с механической блокировкой можно установить максимум 3 вспомогательных контакта.  
● Перед установкой вспомогательного контакта ознакомьтесь с буклетом с инструкциями NNZ5266201/NNZ9700401.

**zh** ● 在 2 个带机械联锁的接触器之间，最多可以安装 3 个辅助触点。  
● 如要安装辅助触点，请参阅说明书 NNZ5266201/NNZ9700401。



# 5

## LA9G750: Changeover Bar Kits / Jeux de connexions puissance pour inverseur de source / Kits de barra de comutación / Leistungsanschlusssätze für Wendeschütze (Quellenumschalter) / Kit barre commutazione / Kits de barras de troca / Комплекты штанг для инверсии полярности источника питания / 电源转换端子连接排

3P	
LC1G115-225 LC1G205-245C	LA9G3750
LC1G265-500 LC1G300-475C	LA9G3751
LC1G630-800 LC1G620C	LA9G3752



4P	
LC1G115-225 LC1G205-245C	LA9G4750
LC1G265-500 LC1G300-475C	LA9G4751
LC1G630-800 LC1G620C	LA9G4752

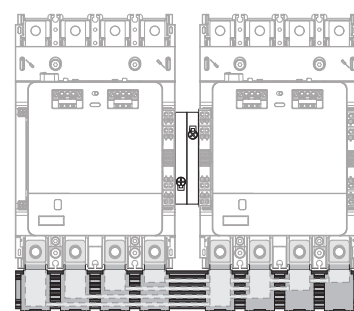
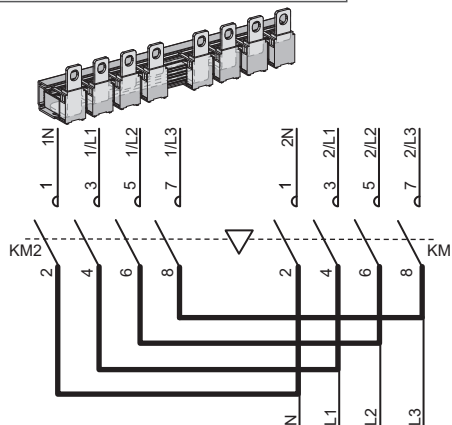
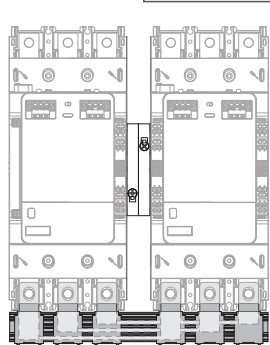
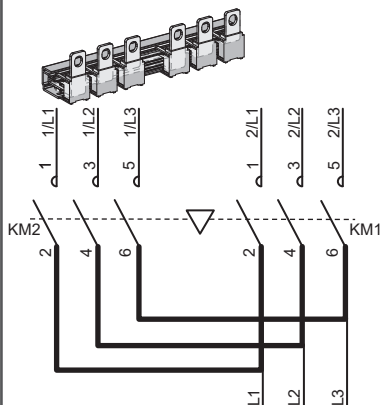

# 6

## LA9G3760: Reverser Bar Kits / Jeux de connexions puissance pour inverseur moteur / Kits de barra de inversión / Leistungsanschlusssätze für Wendeschütze (Motorschalter) / Kit barre invertitore / Kits de barras de reversão / Комплекты штанг для переключения направления вращения двигателя / 正反转端子连接排

3P	
LC1G115-225 LC1G205-245C	LA9G3760
LC1G265-500 LC1G300-475C	LA9G3761
LC1G630-800 LC1G620C	LA9G3762

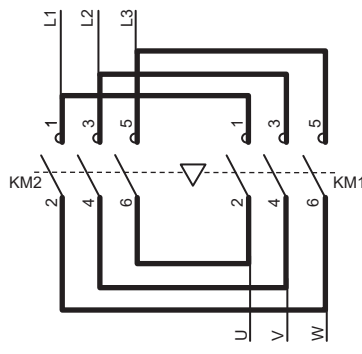
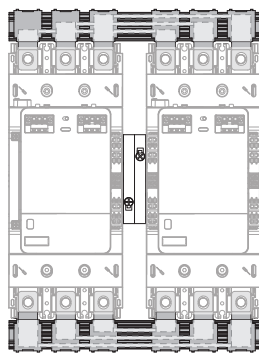
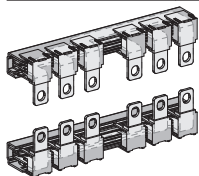

7

## LA9G●●33●: Star-Delta Bar Kits / Jeux de connexions étoile-triangle / Kits de barra Star-Delta / Leistungsanschlusssätze für Stardreieckschütze / Kit barre stella-triangolo / Kits de barras estrela-delta / Комплекты штанг для соединения звезда-треугольник / 星三角端子连接排

L,Δ	Y	3P
<b>LC1G●●●●●A</b>		
LC1G115-225		LA9GQQ330
LC1G265-500	LC1G115-225	LA9GSQ331
LC1G265-500		LA9GSS330
LC1G630-800	LC1G265-500	LA9GTS331
LC1G630-800		LA9GTT330
<b>LC1G●●●●●N</b>		
LC1G115-225		LA9GQQ330
LC1G265-500	LC1G115-225	LA9GSQ330
LC1G265-500		LA9GSS330
LC1G630-800	LC1G265-500	LA9GTS330
LC1G630-800		LA9GTT330
<b>LC1G●●●●●C</b>		
LC1G205-245C		LA9GQQ330
LC1G300-475C	LC1G205-245C	LA9GSQ330
LC1G300-475C		LA9GSS330
LC1G620C	LC1G300-475C	LA9GTS330
LC1G620C		LA9GTT330

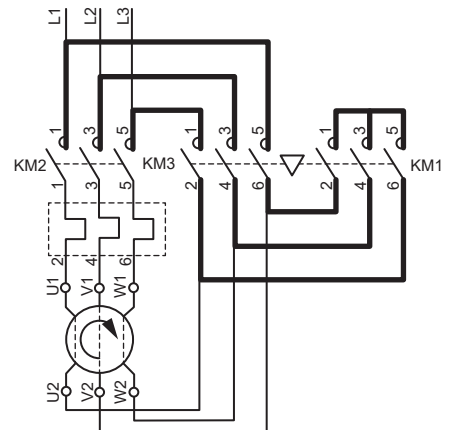
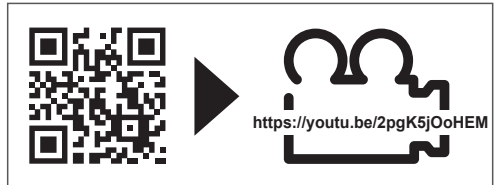
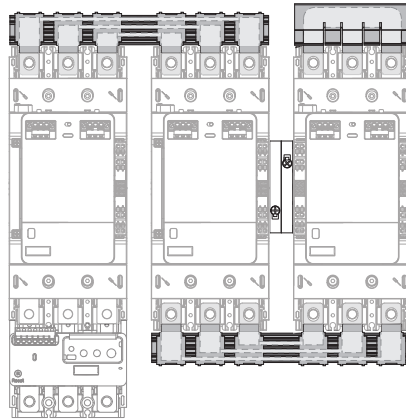
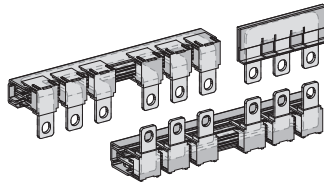

8

## LA9G●W601: Star Bar Kits / Jeux de connexions étoile / Kits de barra Star / Sternanschlusssleisten (Bausätze) / Kit barre stella / Kits de barras estrela / Комплекты штанг для соединения звездой / 星形架构杆套件

	3P
LC1G115-225	LA9GQW601
LC1G205-245C	
LC1G265-500	LA9GSW601
LC1G300-475C	
LC1G630-800	LA9GTW601
LC1G620C	

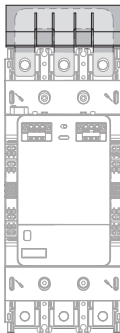
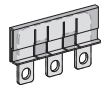

9

## Coupling Bar Connection / Raccordement des jeux de connexions puissance / Conexión de la barra de acoplamiento / Installation der Koppelstangen / Connessione barra di accoppiamento / Conexão de barra de acoplamento / Подключение соединительных штанг / 端子连接排安装

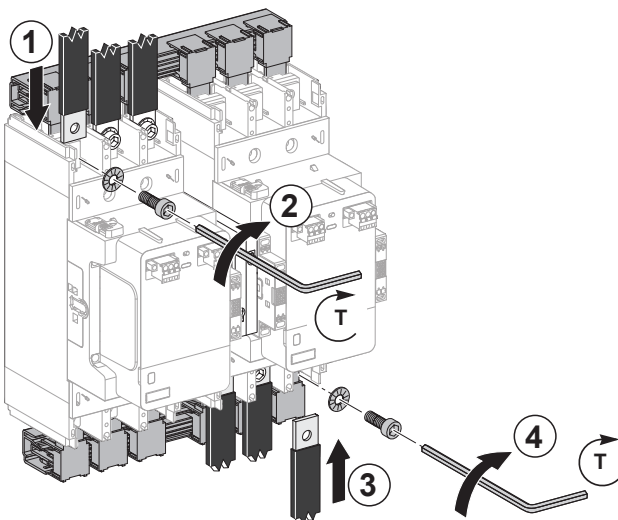

mm in.	LC1G115-225 LC1G205-245C	LC1G265-500 LC1G300-475C	LC1G630-800 LC1G620C
$T$	18±1.8 N•m 159±15.9 lb-in.	35±3.5 N•m 310±31 lb-in.	58±5.8 N•m 513±51.3 lb-in.
	M8	M10	M12
	6	16	18

