



SeT Series

PrismaSeT P Active

Assembly guide 2021



se.com

Life Is On



Legal Information

The Schneider Electric brand and any trademarks of Schneider Electric SE and its subsidiaries referred to in this guide are the property of Schneider Electric SE or its subsidiaries. All other brands may be trademarks of their respective owners.

This guide and its content are protected under applicable copyright laws and furnished for informational use only. No part of this guide may be reproduced or transmitted in any form or by any means (electronic, mechanical, photocopying, recording, or otherwise), for any purpose, without the prior written permission of Schneider Electric.

Schneider Electric does not grant any right or license for commercial use of the guide or its content, except for a non-exclusive and personal license to consult it on an "as is" basis. Schneider Electric products and equipment should be installed, operated, serviced, and maintained only by qualified personnel.

As standards, specifications, and designs change from time to time, information contained in this guide may be subject to change without notice.

To the extent permitted by applicable law, no responsibility or liability is assumed by Schneider Electric and its subsidiaries for any errors or omissions in the informational content of this material or consequences arising out of or resulting from the use of the information contained herein.

PrismaSeT P Active

Assembly guide

Généralités

Safety Information

Important Information	6
Please Note	6
Safety instructions	6
About the Book	7

Introduction

Presentation

Panorama	9
Instructions for use	10
Identify and sort the components	10
Tools	11

Frameworks

Assembling

Presentation	13
Check the condition of the ground in the work area	13
Assemble the framework(s)	14
Install the plinth	14
Couple the frameworks	15

Busbars

Horizontal busbar installation

Presentation	17
Horizontal busbars installation	17

Vertical busbar installation

Panorama of solutions and associated rating	18
In the 150 mm busbar compartment	19
In the 300 mm duct	19
At the rear of the cubicle	19

Busbars coupling

Panorama of solutions	20
Linery LGYE horizontal busbar and Linery LGY vertical busbar	21
Linery LGYE horizontal busbar and Linery LGYE vertical busbar	22
Linery BS horizontal busbar and Linery LGY vertical busbar	23
Linery BS horizontal busbar and Linery BS vertical busbar	23
Linery BS or LGYE horizontal busbar and Linery LGY rear busbar	23
Linery BS or LGYE horizontal busbar and Linery BS rear busbar	23

PE and PEN installation

Install the PE	24
Install the PEN	24

Busbars marking

Neutral, PE and PEN	25
Phase	25

Form 2

Mounting the form 2 partitions	26
--------------------------------------	----

Mounting plate

Mounting plates and switchgear installation

Position of mounting plates	29
Table showing assembly order	30

Switchgear position checking

Inspection	31
------------------	----

Communication system

Wireless panel server and green cover

Wireless panel server assembling	33
Wireless panel server commissioning	34
Commissioning coaching	35

Power circuits

Power cables

Upstream connections	37
----------------------------	----

Secondary distribution blocks

Panorama of solutions	38
-----------------------------	----

Connection terminal blocks and the earth bars

Install the terminal blocks	39
-----------------------------------	----

Wiring running accessories

Install the horizontal and vertical cable straps	40
Install the trunking for horizontal or vertical wiring	40
Install the cable tie-bars	41

Protection accessories

Protection accessories	42
------------------------------	----

Low power and auxiliary circuits

Installation

Installing the devices on door or front plate	45
Installing the wiring running accessories	45

Cabling

Cabling the auxiliary circuits	46
--------------------------------------	----

Switchboard inspection

Final factory inspection

Preparation for tests	49
Routine tests	49
Drafting test reports	50
Wireless panel server test	50
Miscellaneous controls	51
Cleaning	51

Partitioning

Presentation

What are the forms?	53
---------------------------	----

Installation

Installing the incoming unit partitions	54
Installing the form 2	54
Installing the form 3	55
Installing form 4	55

Panels

Generality

Cleaning the switchboard	57
Finishing the front panel	57
Installing the front panel on the framework	58

Roof adaptation for Canalis interface

Roof adaptation to 1250 A ComPacT NS or MasterPacT MTZ1 circuit breakers	59
Roof adaptation to 800 to 3200 A MasterPacT MTZ2 circuit breakers	59
Roof adaptation to 1600 A ComPacT NS or MasterPacT MTZ1 circuit breakers	60
Roof adaptation to 800 to 4000 A MasterPacT MTZ2 circuit breakers	60

Switchboard panels

Fitting the switchboard panels	61
--------------------------------------	----

Pack the switchboard

Packing

Delivery preparation	63
Pack the cubicles	63

Tableau de distribution PrismaSeT P Active

Stay connected to your customers

Simply scan the QR code on the green strip with your smartphone to connect to the switchboard, you and your customer.

Built-in connectivity

PrismaSeT Active switchboards are delivered with a LPWAN gateway built into the panel. The gateway can be used to connect up to 15 wireless sensors to the cloud. This function is provided by default in all PrismaSeT G & P Active cubicles and is optional for PrismaSeT G Active enclosures.



Voltage present indicator lights

Three LEDs on the strip provide information on the switchboard power supply.

Improved enclosure

As well as updating the design, we have strengthened the door and the framework to make the unit more robust and improve the customer experience.

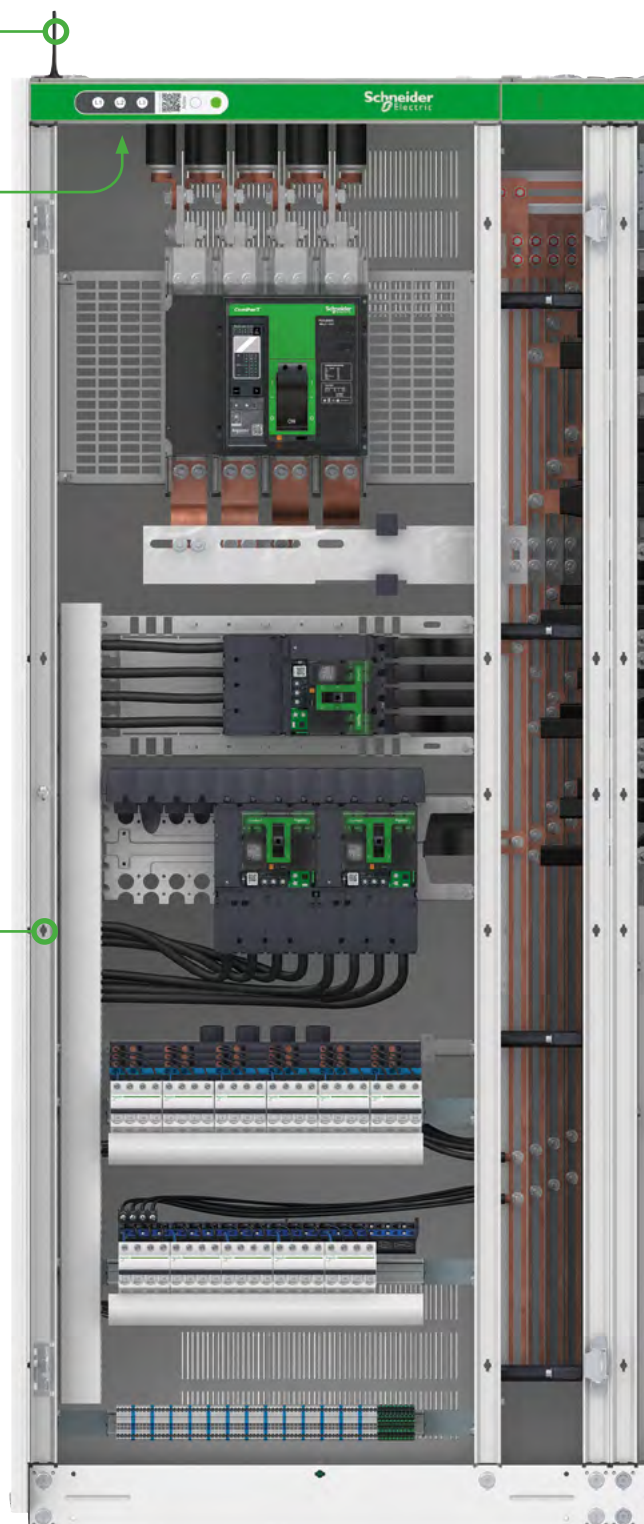

Propose maintenance contracts

You can now offer your customers more services, such as conditional maintenance and fire prevention.

Make your switchboards live

At any time and in less than 30 minutes you can add extra sensors to:

- provide fire prevention services,
- supervise the availability of the loads,
- measure the energy consumptions

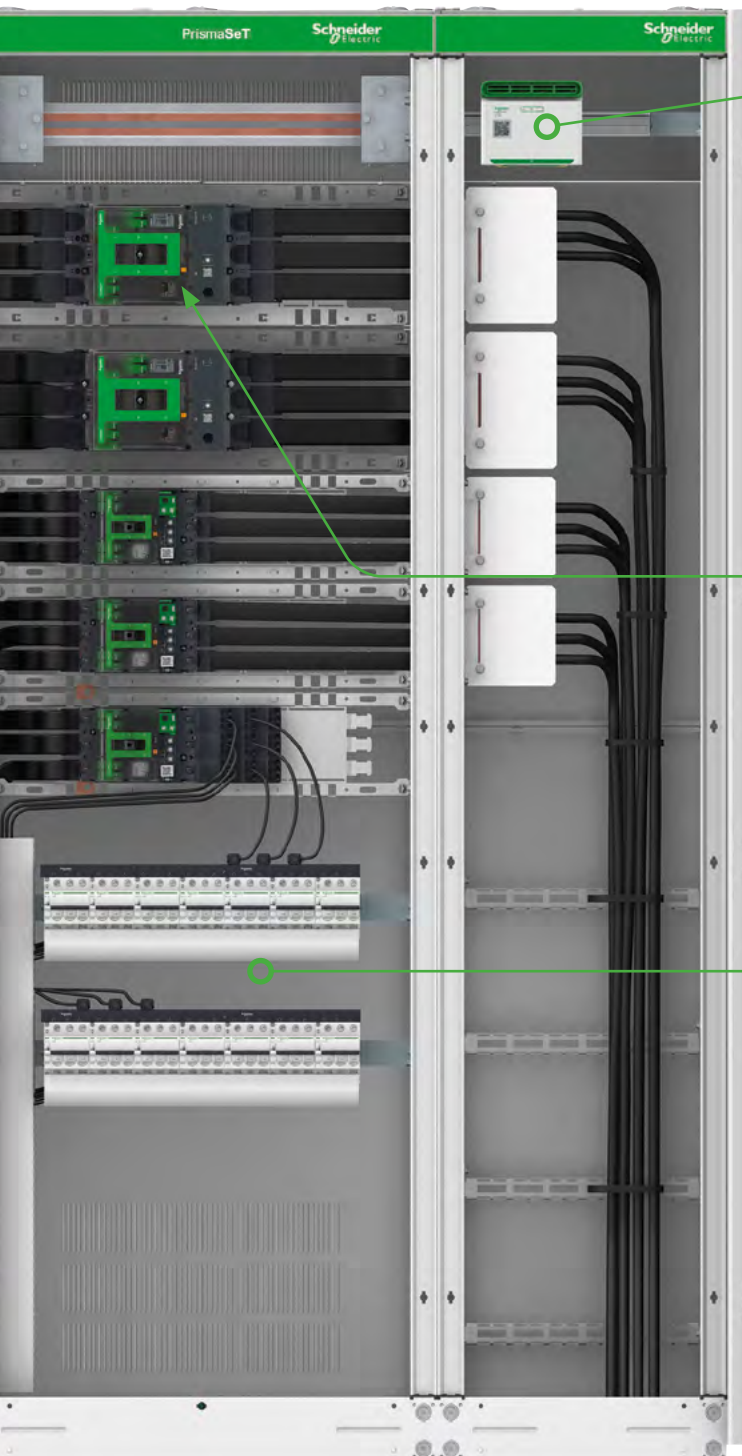

PowerLogic HeatTag

Fire prevention has been taken to a higher level with a new revolutionary sensor which allows the building operators to anticipate and help prevent electrical fires.



ComPacT circuit breakers

The new generation of ComPacT circuit breakers maximizes the availability of the power supply and transmits information concerning its status via a wireless link.

Its installation and maintenance are therefore simplified.

PowerLogic PowerTag

Our compact high-performance PowerTag Energy sensors accurately monitor the energy consumption and communicates this data by wireless transmission to your mobile phone in real time.

Important Information

Read these instructions carefully, and look at the equipment to become familiar with the device before trying to install, operate, service, or maintain it. The following special messages may appear throughout this documentation or on the equipment to warn of potential hazards or to call attention to information that clarifies or simplifies a procedure.



The addition of this symbol to a DANGER or WARNING safety label indicates that an electrical hazard exists which will result in personal injury if the instructions are not followed.



This is the safety alert symbol. It is used to alert you to potential personal injury hazards. Obey all safety messages that follow this symbol to avoid possible injury or death.

⚠ DANGER
DANGER indicates a hazardous situation which, if not avoided, will result in death or serious injury.

⚠ WARNING
WARNING indicates a hazardous situation which, if not avoided, could result in death or serious injury.

⚠ CAUTION
CAUTION indicates a hazardous situation which, if not avoided, could result in minor or moderate injury.

NOTICE
NOTICE is used to address practices not related to physical injury.

Please Note

Electrical equipment should be installed, operated, serviced, and maintained only by qualified personnel. No responsibility is assumed by Schneider Electric for any consequences arising out of the use of this material.

A qualified person is one who has skills and knowledge related to the construction and operation of electrical equipment and its installation, and has received safety training to recognize and avoid the hazards involved.

Safety instructions

⚠ ⚠ DANGER
HAZARD OF ELECTRIC SHOCK, EXPLOSION OR ARC FLASH
<ul style="list-style-type: none"> • Apply appropriate personal protective equipment (PPE) and follow safe electrical work practices. See NFPA 70E, CSA Z462 or local equivalent. • This equipment must only be installed and serviced by qualified electrical personnel.. • Checks to ensure that the circuit breaker is de-energised must be carried out on the upstream and downstream terminals. • Always use a properly rated voltage sensing device to confirm power is off. • Install safety barriers and display a danger sign. • During the tests, it is strictly forbidden for anyone to touch the circuit breaker or the conductors while voltage is applied. • Before putting the equipment back into operation, it is mandatory to check that all connections are made with the correct tightening torque, the inside of the cabinet is clean, all devices, doors, and protective covers are in position and the circuit breaker is off (open position). <p>Failure to follow these instructions will result in death or serious injury.</p>

About the Book

SeT Series Master Range

Featuring outstanding medium-voltage (MV) and low-voltage (LV) switchboards, motor control centers and power distribution solutions for high-performance power applications, Schneider Electric's SeT Series is best-in-class solutions based on high levels of safety and an optimized footprint. Built on a modular architecture and incorporating smart connected devices for maximum safety, reliability, performance and energy efficiency, the SeT Series is delivered to customers directly from our Schneider Electric plants or via a global network of licensed partner panel builders, who are trained and audited to provide quality equipment and support.

Document Scope

This guide proposes a procedure for PrismaSeT P assembling.

We have designed it to help you successfully complete your projects. It ensures that assembling and cabling staff, for whom it is intended, will benefit from the considerable experience in this field acquired by Schneider Electric and its customers. In short, it is an essential workshop tool.

There are several approaches for assembling PrismaSeT P components. In this guide we propose one approach which you can add to according to your professional organisation and experience.

This guide does not replace the instruction sheets supplied in the packing of each component. It recommends an assembly sequence for the components and provides information to complement that given in the instruction sheets (assembly tips and tricks, specific assembly recommendations, warnings, etc.).



Validity Note

This guide applies to PrismaSeT P Active offer.

Online Information

The information contained in this guide is likely to be updated at any time. Schneider Electric strongly recommends that you have the most recent and up-to-date version available on www.se.com/ww/en/download. The technical characteristics of the devices described in this guide also appear online. To access the information online, go to the Schneider Electric home page at www.se.com.

Related documents

Title of documentation	Reference number	QR code
Commissioning Guide For Connected Panels and EcoStruxure Facility Expert Software	ESXP1G004EN	
PrismaSeT Wireless Panel Server User guide	DOCA0197EN	
EcoStruxure Panel Server User guide	DOCA0172EN	

You can download these technical publications and other technical information from our website at <https://www.se.com/en/download>.

Introduction

Introduction

Presentation

Panorama

1 - Framework

- Framework upright
- Top cross-member
- Bottom cross-member
- Cable compartment upright

2 - Mounting plates and switchgear

- Mounting plate support
- Mounting plate
- Acti 9 mounting plate: Multifix rail
- MasterPacT incoming unit
- ComPacT NSX device
- Acti 9 switchgear

3 - Busbars

- Bottom support for the Linergy channelled busbar
- Linergy busbar support
- Linergy busbars and/or Linergy Evolution busbars
- Insulated flexible bar prefabricated connection
- Rigid bar prefabricated connection
- Neutral bar
- PE protective conductor

4 - Distribution blocks

- Linergy FP (Polypact)
- Linergy FM (Multiclip)
- Comb busbar

5 - Wiring running

- Trunking
- Trunking for thin wiring

Power cables

- Connection transfer assembly in cable compartment
- Protective barrier
- Tie support

Partitioning

- Form 2 barrier

6 - Front panel finish

- Front plate support frame
- Front plate

7 - Cover panels

- Rear panel
- Side panel
- Door
- Roof



Introduction Presentation

Instructions for use

This guide describes a procedure for assembling the PrismaSeT P.

It indicates the order in which the cubicle components are to be assembled: the technical assembly instructions are found in the instruction sheets supplied in the packaging of each component.

Step 1

Before starting to assemble, you must first identify and sort the components.

Step 2

The actual assembly process has divided up into 7 stages, and organised as follows:

- 1 Assembling the framework
- 2 Installing the busbars
- 3 Installing the mounting plates
- 4 Install the wireless panel server and green cover
- 5 Running and cabling the power circuits, the low power and auxiliary circuits
- 6 Installing the partitioning
- 7 Finishing the front panel and fitting the switchboard panels

Step 3

Testing as per standard IEC 61439-2 must be carried out.

Step 4

The last stage consists of packing the switchboard to ensure protection of the cubicles during transport.

Identify and sort the components

Aim: Identify and sort components to ensure subsequent proper working organisation and fewer handling operations.

- Identify the assembly stage pictogram shown in the assembly instruction sheet.
- Group the components, devices and accessories, by assembly stage, from assembling of the rear panel through to fitting the cubicle panels.
- Collect the components that will be used by the contractor, but do not unpack them.

Tip

When you receive your components in your workshop, don't get carried away, don't unpack everything...

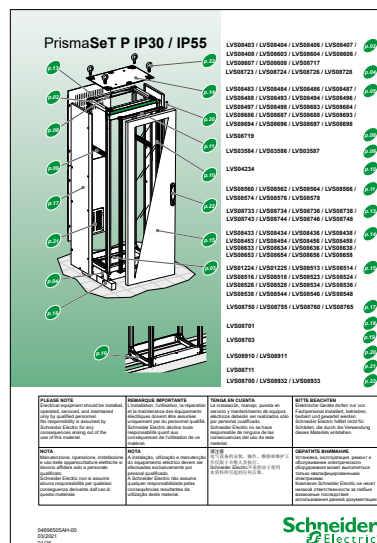

General instruction sheet for cubicle

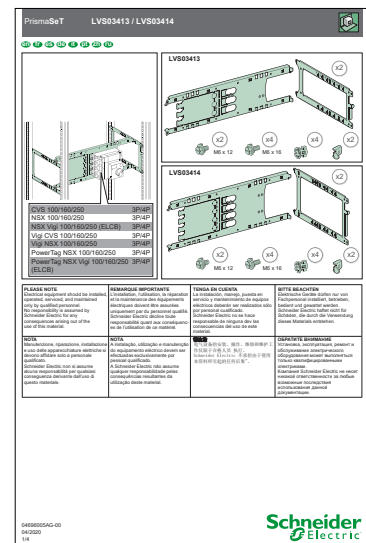

Individual instruction sheet for component

Introduction

Presentation

Tools

The recommended tool lists for this section are not exhaustive, but represent the minimum tools required to assemble, cable and inspect the PrismaSeT P cubicles.

Assembling and cabling tools

Individual tools

The tool kit belonging to the assembling and cabling staff must contain at least the following tools:

Type of assembly	Tools
<ul style="list-style-type: none"> • Switchboard mounting: enclosure, mounting plates and panels except for equipments 	<ul style="list-style-type: none"> • 1 ratchet wrench • 1 extension piece • 1 x 10 and 13 mm wrench • 1 wrench bit socket • 1 screwdriver • 1 wrench bit for screwdriver • 1 x 5 mm hexagon socket bit • 1 wrench bit for pozidriv no. 2 recess • 1 x 8 mm flat screwdriver • 1 portable jig-saw
<ul style="list-style-type: none"> • Mounting the equipments and tightening the connections (ComPacT NSX, etc.) 	<ul style="list-style-type: none"> • Sockets 7, 8, 10, 13, 16, 17 and 19 mm • Hexagon sockets bit 4, 5, 6, 8 and 10 mm • Wrench bit for pozidriv no. 1, 2 and 3 recess
<ul style="list-style-type: none"> • Cabling the switchboard 	<ul style="list-style-type: none"> • 1 flat screwdriver 3.5 mm - 4 mm- 5.5 mm • 1 pozidriv no. 2 screwdriver • 1 electrician's knife • 1 x 6 mm hexagon socket bit • 1 flat nose pliers • 1 stripping pliers • 1 cable cutter • 1 crimping tool • 1 diagonal cutting pliers • 1 half round nose pliers • 1 bell or tester • Ring spanner type terminal ends for torque wrench

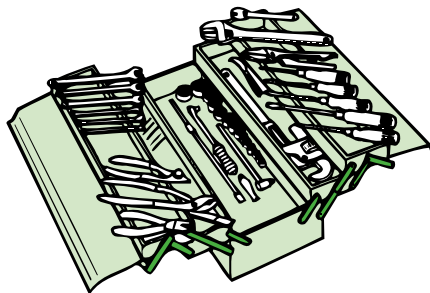

Group tools

- 1 torque wrench with socket and ring spanner type terminal ends to tighten all electrical connections to the required torque (max. torque 50 Nm).
- 1 ratchet wrench to tighten all busbar connections and joints using shear nuts.
- 1 set of shears to cut flexible bars.
- 1 punching machine for flexible bars.
- 1 electrical saw.
- 1 drill.
- 1 vacuum cleaner for switchboard cleaning.

! When crimping the lugs, only the pliers recommended by the lug manufacturer must be used.

Inspection tools

Individual tools

The quality inspector's basic individual tools are the same as for the assembling and cabling staff, with in addition the few tools below:

- 1 small hinged mirror.
- 1 electrical lamp or portable lamp.

Group tools

- 1 control console.
- 1 dielectrometer.
- 1 multimeter.

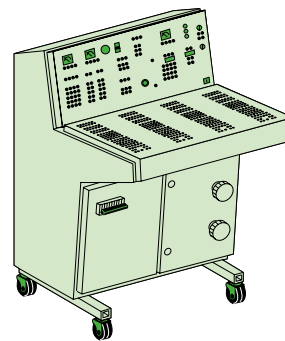

Assembling the frameworks

Frameworks Assembling

Presentation

This stage consists of assembling the structure and carrying out the various combinations if required.

A variety of framework types are available:

- Depth: 400 or 600 mm.
- Width: 300,400,650 or 800 mm.

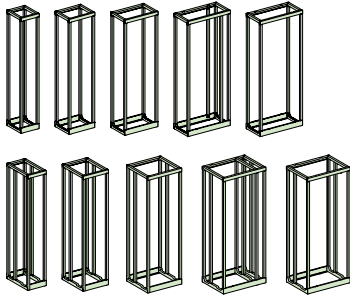

Tip

To produce disconnectable-type switchboards, you must use a 600 mm deep and 650 mm wide cubicle and a 300 or 400 mm wide and 600 mm deep cable compartment, placed to the right of the cubicle.

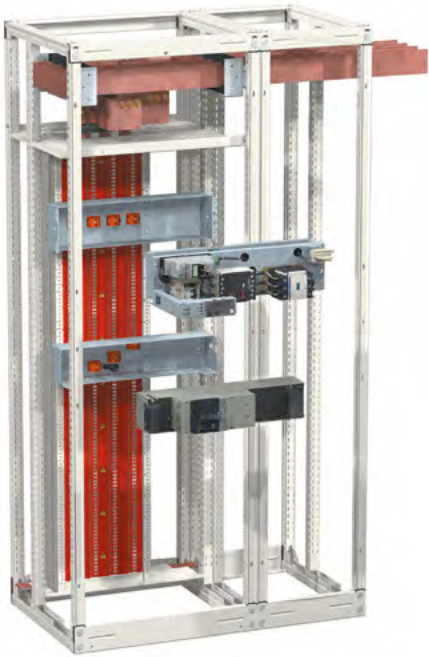

Note: The doors, lateral and rear panels are assembled once the internal components have been mounted and cabled, thus guaranteeing 100% access to components throughout assembly and installation.

Check the condition of the ground in the work area

- The place of installation of the switchboard must be cleaned.
- If possible, apply a dust-proof paint on the floor to limit pollution inside the switchboard.
- It is necessary to have a flat floor: + or - 2 mm/m.
- For floors with flatness > 2 mm/m, it's necessary to provide :
 - either U or I sectionned supports, whose straightness and level must be checked in both directions,

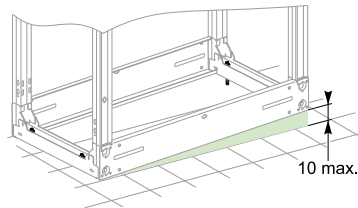

- or to install the leveling kit (CR no **LVS08702**) which can compensate up to 10 mm of flatness defect.

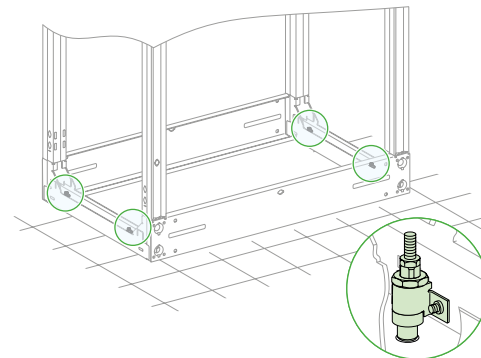
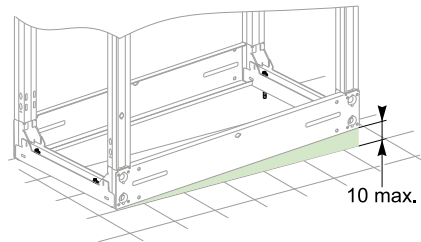

- Systematic use of sectioned supports is recommended to simplify mechanical assembly between cubicles and fishplating of busbars.

Tip

If the implementation of the leveling kit is impossible, it is important to use another leveling system to get good vertical and horizontal switchboard position. In case of squareness is not conform, the door could be misaligned.

Frameworks Assembling

Assemble the framework(s)

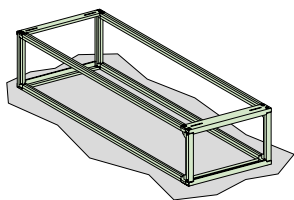

- The frameworks must be assembled on a flat surface, protected to ensure the painting is not damaged.
- When assembling the vertical upright, take care not to damage the gaskets located at the end of the upright.
- Follow the frame assembly rules (see instruction sheet N° 04696505AH)

Squareness control

- After assembling the framework, we recommend checking the verticality and horizontality with a bubble level.
- The squareness control has to be made on each column.

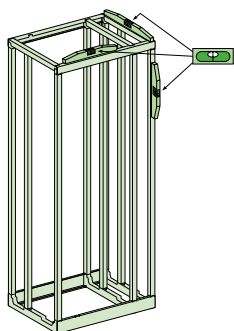

If the squareness is not conform, we recommend to unscrew the screw which maintain the frame in order to realign it.

Note: in case of squareness is not conform, the door could be misaligned.

Tip

Remember to use a booster seat to allow passage dedicated to pallet truck or fork-lift using. d before the switchboard panels are fitted.

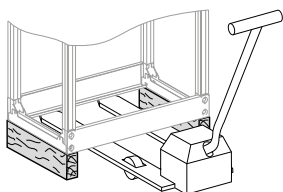

Install the plinth

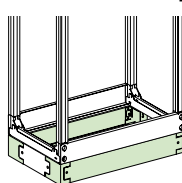

Simple plinth

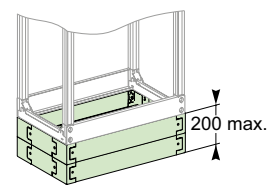
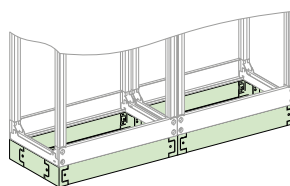

Double plinth

- Install the plinth to permit to use fork-lift.
- The plinth accessories can be used in case of cables with a large radius of curvature.

Frameworks Assembling

Couple the frameworks

In case of the cubicles have to be delivered separately:

- store the combination kits,
- couple temporarily using bolts.

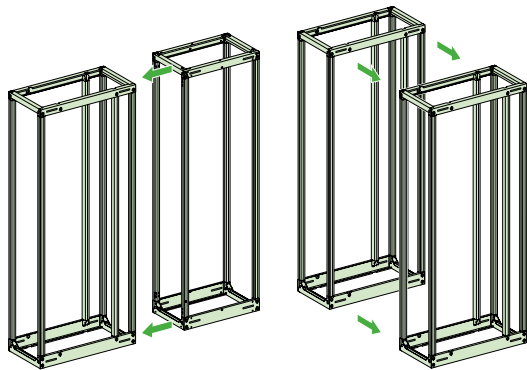

Tip

For IP55 cubicles, do not forget to fit the gasket at the junction of the cubicles to be coupled. To dust off and to degrease the surfaces thoroughly before sticking on the gaskets.

Note: For an L-shaped combination, the right-angle kit will be assembled on site.

Cubicle handling and rolling

- This type of base is designed to avoid any risk of cubicle deformation during transport and handling.
- Five different catalogue numbers offer 27 width possibilities (1200 to 3050 mm) for 400 and 600 mm deep cubicles.

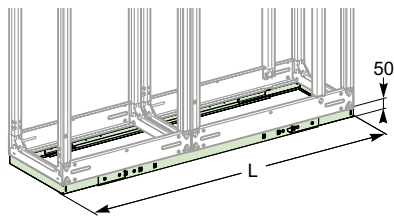
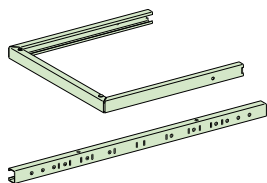

Install the gland plate support on the frames

- For reasons of accessibility, the frames will be mounted immediately, while the gland plates will be mounted before the switchboard panels are fitted.

Tip

Depending on the position of the horizontal busbars in the framework, the association of two columns is carried out as follows:

- if the busbar is in the upper position, put the long screws and their spacers on the upper part of the vertical uprights, and place the bolt without spacer on the lower horizontal crossbar, as illustrated below,
- if the busbar is in the low position, put the long screws and their spacers on the lower part of the vertical uprights, and place the bolt without spacer on the upper horizontal crossbar.

Illustration of frame association with busbar in the upper position

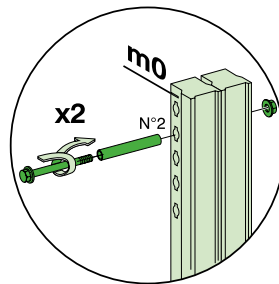

Long screw spacer at the top

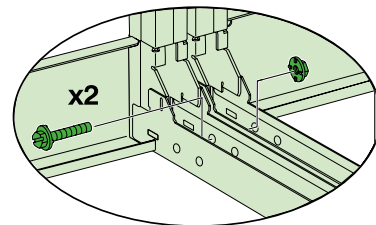

Bolt without spacer at the bottom

Busbars

Horizontal busbar installation

Presentation

This stage consists of positioning the supports and bars making up the busbars.

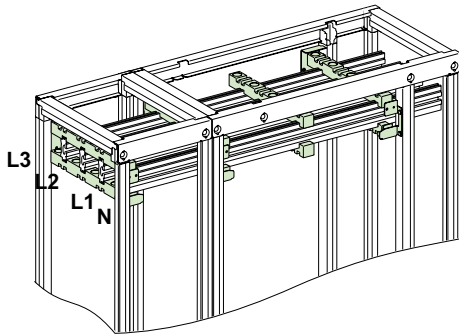

Tip

If cutting oil is used to cut the bars, they must be cleaned prior to assembly because oil adversely affects electrical conductivity. If the copper bars Linergy BS or tracks of Linergy LGY / LGYE have become oxidised, you can recover the quality of the connection using a soft micro-abrasive cloth.

Note:

- Busbar overall dimensions never change whatever the current and temperature conditions.
- Whatever the busbar type (copper flat bars or aluminium profiles), the order of the horizontal and vertical bars is always the same: from the front to the rear N, L1, L2 and L3.
- With the vertical rear busbars, the Neutral is at the left position, then L1, L2, L3.

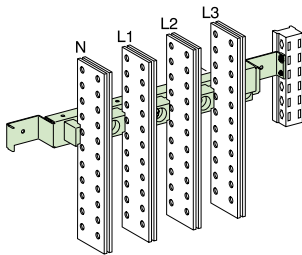

Horizontal busbars installation

Install the horizontal busbars at the top or bottom of the cubicle.

- The dimensions are:
 - 3 modules at the top or bottom for Linergy BS up to 3200 A ($\leq 100 \text{ mm} \times 10 \text{ mm}$) or Linergy LGYE up to 2500 A.
 - 4 modules at the top and 3 modules at the bottom for Linergy BS 4000 A ($120 \text{ mm} \times 10 \text{ mm}$).
 - 4 modules at the top or bottom for Linergy LGYE 3200 A or 4000 A.
 - In case of connection between a horizontal and vertical rear busbars, dimension change to 5 modules.
- If the busbar is at the bottom, fit a form 2 partition to prevent the risk of falling tools.

Tip

A cable duct using can simplify the installation.

Separated cubicles for transportation

- If cubicles have to be separated for transportation, provide horizontal busbar joints. The joints will be assembled on site and should preferably be used at the inter-cubicle connections to simplify replacement.
- Ensure a 10 mm space between the bars to be joined, i.e. 5 mm from the edge of the cubicle.
- **LVS04624** is mandatory in case of jointed 4P Linergy LGYE busbars installations and must be installed only at the junction on side-by-side frameworks combination.
- When installed at the bottom of cubicles, the busbars must be partitioned. Linergy LGYE joints are used exclusively with the stud plates and shear nuts supplied in the enclosed kit.
- The stud plate design perfectly centres the joints on each bar ensuring compliance with the 10 mm distance between 2 bars to connect.

Cutting Linergy LGYE for joining

- Linergy LGYE is cut with a circular saw, starting from the side with the copper contact track. Once it has been cut, make sure there are no shavings or burrs on the copper contact track. If cutting oil is used, the bars must be cleaned prior to assembly.



Tip

When cutting the bars, gloves and protective goggles must be worn to protect injuries.







Shavings and burrs: not good

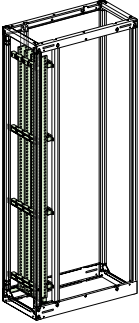
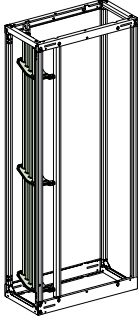
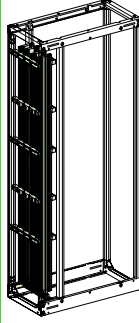
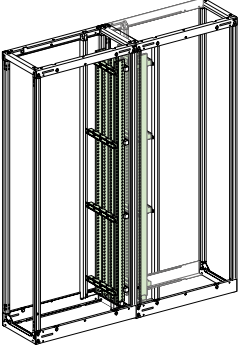
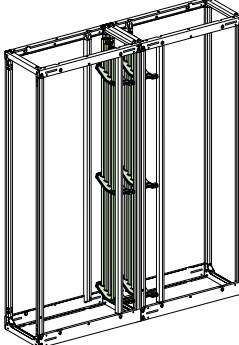
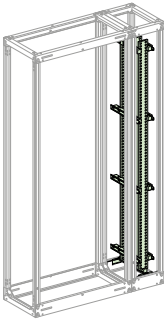

Clean contact surfaces: good

Vertical busbar installation

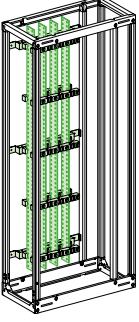
Panorama of solutions and associated rating

	Linergy BS		Linergy LGY		Linergy LGYE	
	simple busbar	double busbars	simple busbar	double busbars	simple busbar	
in 150 mm compartment						
	IP ≤ 31	1800 A	2820 A	1650 A	-	2440 A
	IP > 31	1600 A	2820 A	1480 A	-	2100 A
in 2 x 150 mm compartments						
	IP ≤ 31	-	3200 A	-	3200 A	-
	IP > 31	-	3340 A	-	2920 A	-
in 300 mm cable duct						
	IP ≤ 31	-	3760 A	-	-	3620 A
	IP > 31	-	3340 A	-	-	3350 A
rear of cubicle						
	IP ≤ 31	1000 A	1800 A	1650 A	-	-
	IP > 31	1600 A	1600 A	1480 A	-	-

Busbars

Vertical busbar installation

In the 150 mm busbar compartment

Install the single busbar

- Busbar compartment can be on the right or on the left position.

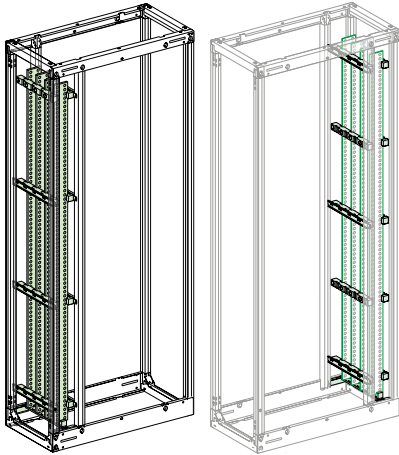

Install the double busbars

- 3 equipotential bonding connections are required between the busbars.
- Consult the PrismaSeT P or Linergy catalogs to determine the number of supports as a function of installation Icw.

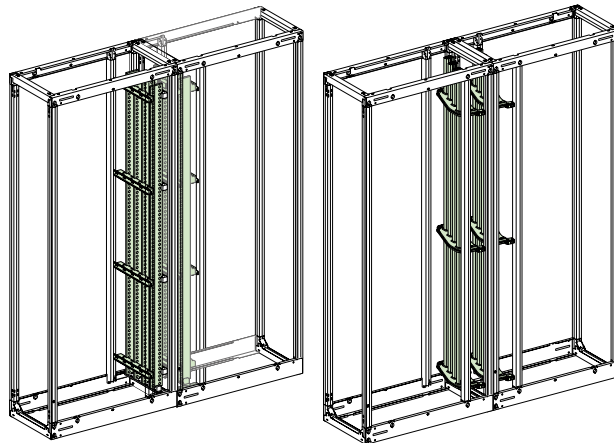

In the 300 mm duct

Install the single busbar

- Busbar compartment can be on the right or on the left position.

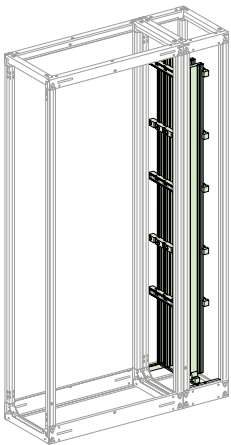

At the rear of the cubicle

Rear busbar

- The rear busbar is installed at a depth of 400 or 600 mm.

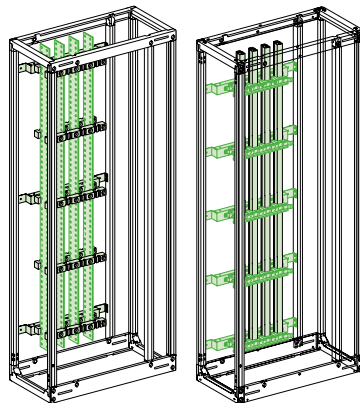

Busbars

Busbars coupling

Panorama of solutions

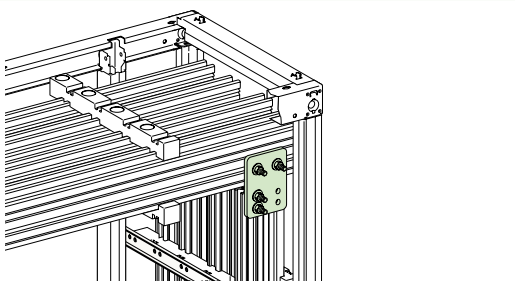
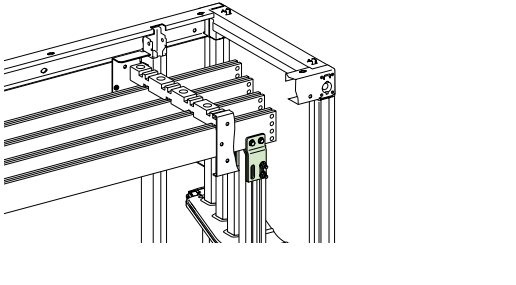
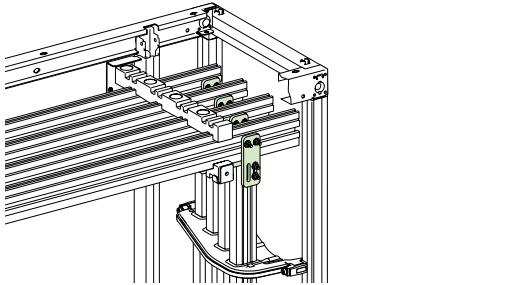
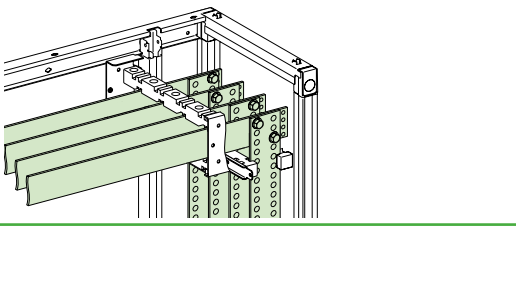
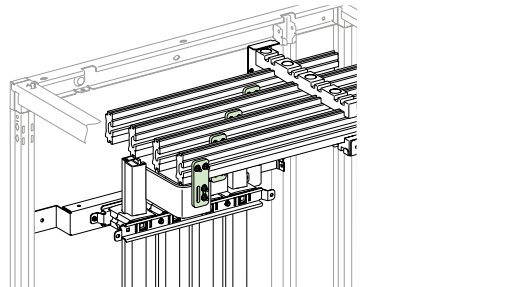
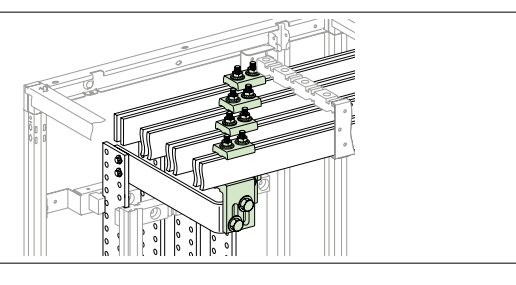
		Horizontal busbars	
		Linergy BS	Linergy LGYE
Vertical busbar in compartment or cable duct	Linergy LGYE		
	Linergy LGY		
	Linergy BS		
Vertical busbar at the back of the cubicle	Linergy LGY		
	Linergy BS		

Busbars coupling

Linergy LGYE horizontal busbar and Linergy LGY vertical busbar

in busbar compartment

Tip

It is recommended to use torque nuts to secure the inter-busbar connections. In case of you use other nut types, we recommend to apply Swiss varnish on each nut tightened to its torque.

Tightening the nuts of the fishplates must be done gradually and alternately between all the nuts until the nominal torque is reached.

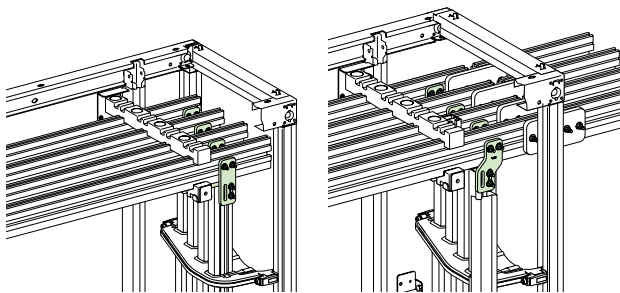

Right connections:
75 mm between centers
of each horizontal busbar

Shifted connections:
115 mm between centers
of each horizontal busbar

Note: LVS04603 shifted connections allow vertical connection with the Linergy LGYE ≤ 1600 A and joining in the same 150 mm duct.

Linergy LGYE 3200-4000 A

- Linergy LGYE 3200-4000 A horizontal installation requires 4 modules. Then, before connection between both Linergy busbars, LGY vertical busbars must be cut to 1620 mm (remove 50 mm).

Cutting Linergy LGY

- Linergy LGY is cut with a circular saw, starting from the side with the copper contact track.
- Once it has been cut, make sure there are no shavings or burrs on the copper contact track. If cutting oil is used, the bars must be cleaned prior to assembly.

⚠ CAUTION

DURING THE BARS CUTTING OPERATION, THERE IS A RISK OF CUTTING AND PROJECTIONS IN THE EYES.

Gloves and protective goggles must be worn to protect hands and eyes.

Failure to follow these instructions can result injury.

Busbars

Busbars coupling

Linery LGYE horizontal busbar and Linery LGYE vertical busbar

• Linery LGYE connections are exclusively used with the stud plates and shear nuts supplied in the connection.

In 150 mm busbar compartment

630 to 1600 A busbar

• Length of vertical installation : 1675 mm has to be cut from 2000 mm

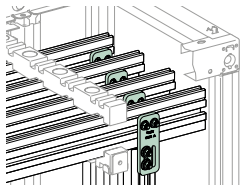

Note: Beyond 1600 A, horizontal/vertical busbar connection and joining in the same duct is no longer possible.

2000 to 2500 A busbar

• Length of vertical installation : 1625 mm has to be cut from 2000 mm
• The 2000-2500 A busbar are provided with only one copper contact track asymmetrically positioned. Then, according to the direction of installation busbar (copper contact track up or down), short or long vertical connections can be used.

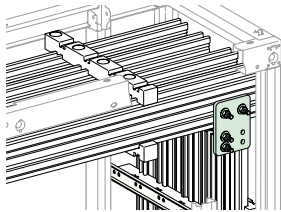

Track down

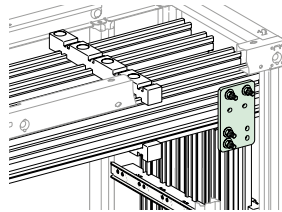

Track up

In 300 mm duck

3200 to 4000 A busbar

• Length of vertical installation : 1625 mm has to be cut from 2000 mm



Cutting Linery LGYE

• Linery LGYE is cut with a circular saw, starting from the side with the copper contact track. Once it has been cut, make sure there are no shavings or burrs on the copper contact track. If cutting oil is used, the bars must be cleaned prior to assembly.

⚠ CAUTION

DURING THE BARS CUTTING OPERATION, THERE IS A RISK OF CUTTING AND PROJECTIONS IN THE EYES.

Gloves and protective goggles must be worn to protect hands and eyes.

Failure to follow these instructions can result injury.

Busbars

Busbars coupling

Linergy BS horizontal busbar and Linergy LGY vertical busbar

In 150 mm busbar compartment

- Connection of a 10 mm thick horizontal busbar requires no holes to be drilled, unlike the 5 mm thick horizontal busbar.

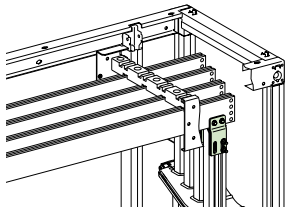

5 mm bar Linergy BS

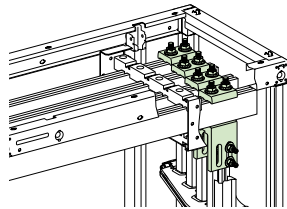

10 mm Linergy BS

Tip

It is recommended to use torque nuts to secure the inter-busbar connections. In case of you use other nut types, we recommend to apply Swiss varnish on each nut tightened to its torque. Tightening the nuts of the fishplates must be done gradually and alternately between all the nuts until the nominal torque is reached.

Linergy BS horizontal busbar and Linergy BS vertical busbar

In 150 mm busbar compartment

- For this connection type, holes must be drilled on the 5 mm horizontal bars.

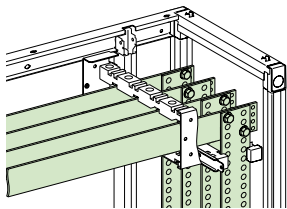

5 mm bar Linergy BS

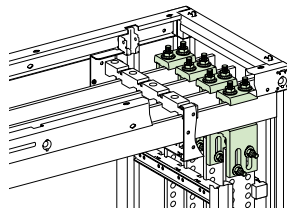

10 mm Linergy BS

Linergy BS or LGYE horizontal busbar and Linergy LGY rear busbar

At the back of the cubicle

- This connection type must be carried out by the assembling and cabling staff. For the dimensions of the bars to be made, consult the busbar drawing collection.

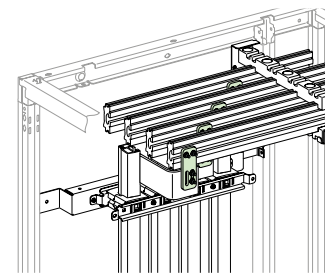

Linergy BS or LGYE horizontal busbar and Linergy BS rear busbar

At the back of the cubicle

- This connection type must be carried out by the assembling and cabling staff. For the dimensions of the bars to be made, consult the busbar drawing collection.

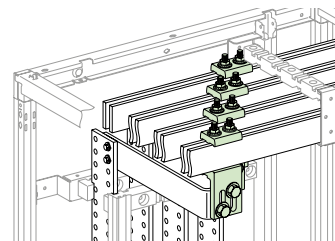

PE and PEN installation

Install the PE

Vertical mounting

- It is normally installed in the cable compartment,

Horizontal mounting

- It is installed at the top or bottom of the switchboard opposite the horizontal busbar.

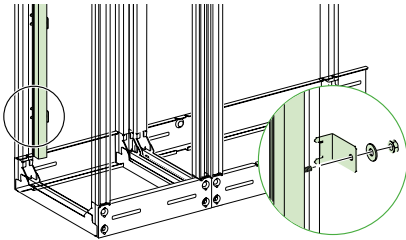

Note: If the cubicles have to be separated for transport, produce PE joints.

Install the PEN

- The PEN is mounted vertically, normally in the cable compartment.
- It must be connected to the neutral by a removable joint allowing subsequent taking of insulation measurements.

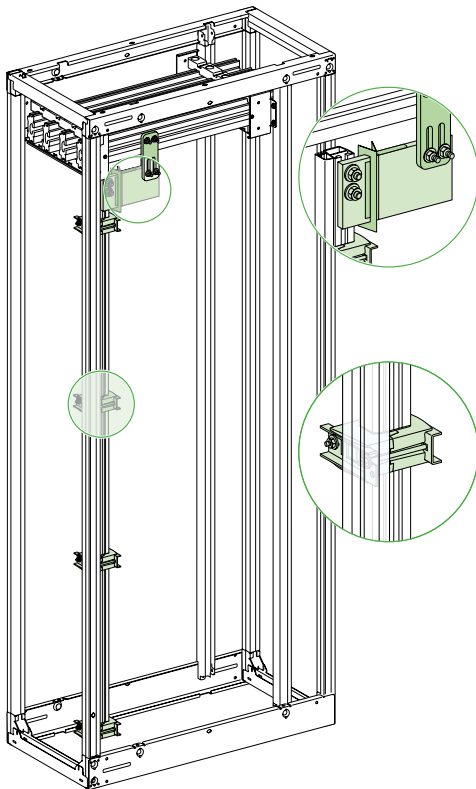

Busbars marking

Neutral, PE and PEN

- Marking of the protective conductors, neutral, PE and PEN, is compulsory.
- Phase marking is strongly recommended.

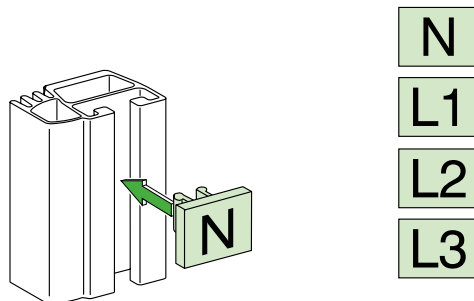

Phase

- Phase marking is strongly recommended.

Busbars

Form 2

Mounting the form 2 partitions

Side barrier

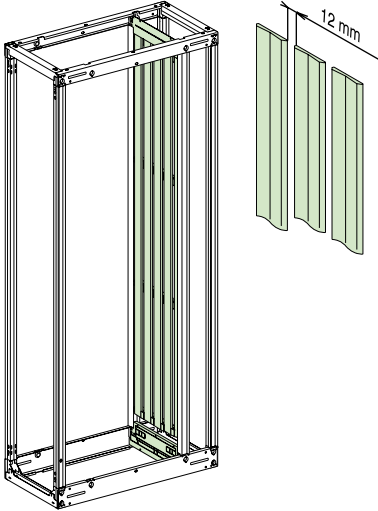

- The form 2 side barrier allows insertion of flexible or rigid connections less than 12 mm thick between 2 flaps.

Interruption kit

- To allow insertion of the connection for a large rating device (MasterPacT MTZ1&2 ComPacT NS 630b 1600 A, etc.) to a lateral vertical busbar, and if a Linergy FC (Polypact) with flexible connections is used (CR no. [LVS04405](#), [LVS04406](#) for ComPacT NSX - cat. no. [LVS04412](#), [LVS04413](#), [LVS04417](#) for ComPacT NSXm) with form 2, a side barrier cut-out must be installed.

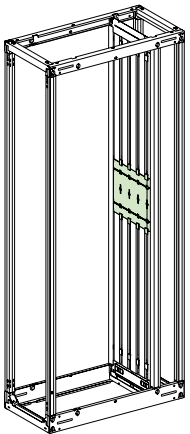

- To identify the position of this interruption, the location of the power devices must be anticipated on their mounting plate and the following order complied with:
 - install the interruption kit,
 - then the side shield blades.

⚠ CAUTION

DURING THE SIDE BARRIERS CUTTING OPERATION, THERE IS A RISK OF CUTTING AND PROJECTIONS IN THE EYES.

Gloves and protective goggles must be worn to protect hands and eyes.

Failure to follow these instructions can result injury.

Lateral partitioning

- Can be installed in the front and rear of the busbar compartment.
- Protects against direct contact with the busbars.
- This barrier is not required in front when the cubicle is equipped with a plain or transparent door

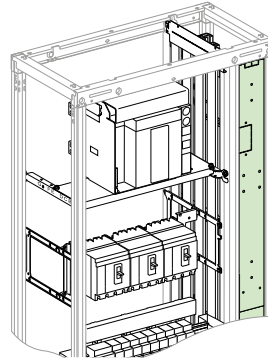

Horizontal partitioning

- Set of two barriers (front and rear), plus a slotted rear panel for efficient natural convection in the switchboard.
- The set can be used to partition horizontal busbars installed at the top or bottom of the cubicle.
- The space required for the busbars is not increased.

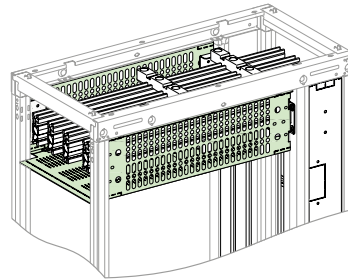

Mounting plate

Position of mounting plates

This stage consists of defining the position of the mounting plates in the cubicle and installing them with their devices.

Order

- The order of assembly of the mounting plates and devices depends on the technical features of the devices.

Position

- To define the position of a mounting plate of a functional unit, you need to know the overall dimensions of the functional unit, i.e. the number of modules (1 module = 50 mm).
- This number is given in the mounting plate instruction sheet and the catalogue.
- The reference m0 is the reference starting point for installation of the first mounting plate.
- There are 2 "m0" references at the top and bottom of the cubicle.

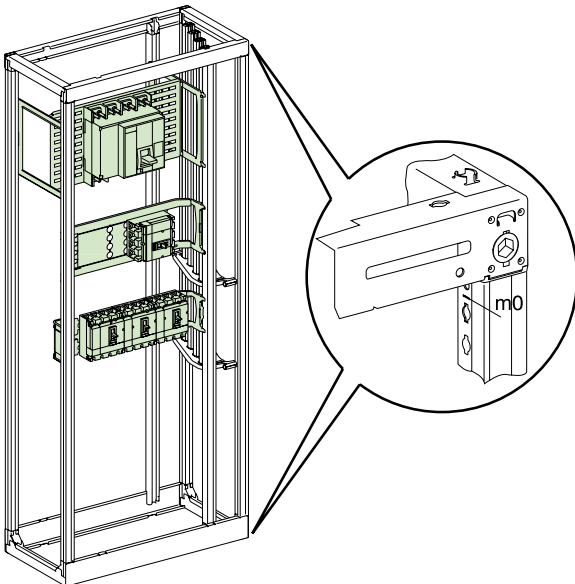

- These marks (m0) are used as reference to measure the height when installing a mounting plate.
- Marks located every 50 mm, with a double marking every 100 mm, simplify module counting.

Table showing assembly order

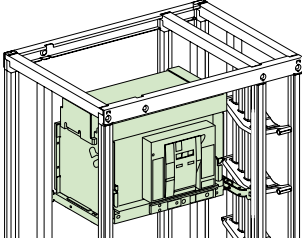
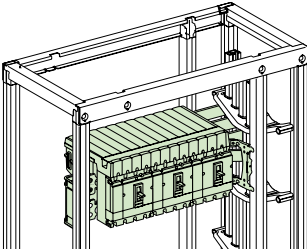
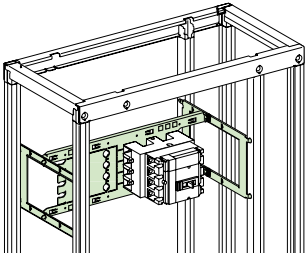
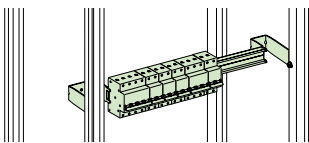
Plates for	Device fixing	Assembly order
MasterPacT MTZ1, MTZ2 ComPacT NS > 630 A and INS > 630 A 	Fixed Withdrawable	<ul style="list-style-type: none"> • Install the mounting plate • Place the device on the mounting plate <ul style="list-style-type: none"> • Install the mounting plate • Install the cradle • Plug the device into the cradle
ComPacT NSX, NSXm and INS/INV 	Supplied by Linergy FC (Polypact)	<ul style="list-style-type: none"> • Insert the Linergy FC, connections facing forward, into the cubicle • Slope the Linergy FC assembly, connections facing downwards, while inserting them between the form 2 barrier slats • Swivel round the Linergy FC in the cubicle and put it in the horizontal position • Install the 2 mounting plate supports, with the right-hand support straddling the first connection • Position and hold the Linergy FC in place above the supports • Secure the mounting plate (without device) onto its supports • Place the Linergy FC on the mounting plate • Assemble the devices
ComPacT NSX, NSXm and INS/INV ≤ 630 A 	Fixed Withdrawable or plug-in	<ul style="list-style-type: none"> • Place the device on the mounting plate • Install the equipped mounting plate <ul style="list-style-type: none"> • Place the base or cradle in the mounting plate • Install the equipped mounting plate • Plug in the device
Modular devices 	Modular system	<ul style="list-style-type: none"> • Install the adapted rail • Place the modular devices on the rail

Switchgear position checking

Inspection

This operation allows operator inspection and prevents incorrect positioning of the functional unit with respect to the front panel, once the cubicle has been fully cabled.

- Mount the front plate support on the frame.
- Install the front plates on the front plate support to check device positioning.
- Also check device positioning in depth.
- Open or disassemble the front plate support after checking to simplify cabling.

Tip

The correct positioning of the functional units on the framework associated to the dedicated front plate guarantees compliance with IP 30/31.
Check the depth position of the mounting plate on the instructions sheet.



Communication system

Wireless panel server assembling

Presentation

- The data exchanges from the switchboard to EcoStruxure Facility Expert require the installation of:
 - a wireless panel server,
 - a green cover,
 - an antenna.

Step 1: wireless panel server installation

- Install the wireless panel server on the top of the frame with two screws.

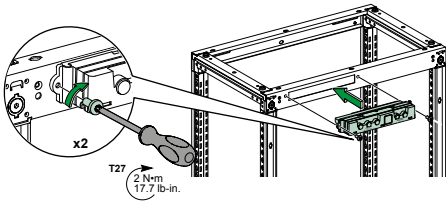

Note: the tightening torque for the fixing screws is 2 Nm / 17.7 lb-in in order to guarantee IP 55 performance.

Step 2: green cover support assembling

- Install the green cover supports on both side of the top of the frame:
 - frame W300, 400 and 650 mm: 2 green cover supports,
 - frame W800 mm: 3 green cover supports.

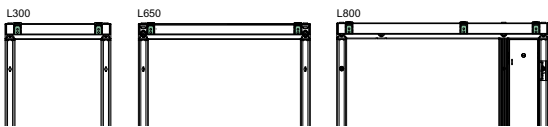
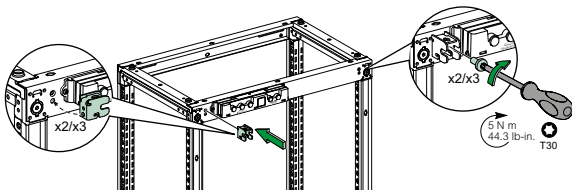

Step 3: cable antenna mounting

- Connect the cable antenna between the wireless panel server and the green cover connector.
- Note:** pay attention to screw the nut manually.

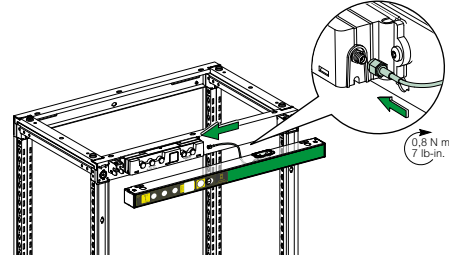

Step 4: green cover installation

- Assemble green bar on the green cover supports.
- Position and fix the 1/4 turn screws located at the bottom of the supports.

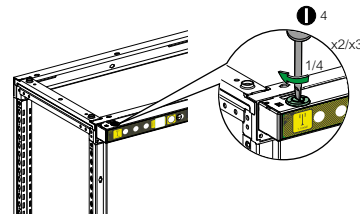

Step 5: antenna positioning

- Screw the antenna wire connector onto the dedicated green cover connector.
- Note:** pay attention on the very low torque value.
- Use LoRa tester to identify the better location to position the antenna.
 - Observe the bending radius if you need to wind the cable (see diagram below).
 - The antenna must imperatively be positioned vertically.

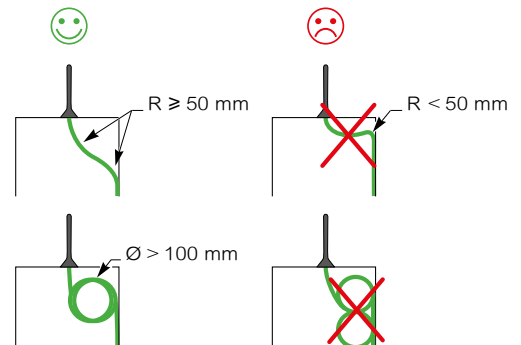

Step 6: antenna delivery

- The antenna will be disassemble and delivered separately in a specific packaging.
- The panel builder will inform about antenna location.

Wireless panel server commissioning

- Download and open the EcoStruxure Power Commission app.

Cloud connection

- Flash the QR code which is located next to the voltage presence indicator light.

You will be guided to:

- download the EcoStruXure Facility Expert app.
- among the 3 choices offered, select "EcoStruxure Facility Expert".
- follow the instructions.

Nota: During the procedure, it is necessary to press the button next to the QR code: keep it pressed for more than 5 seconds.

For more information

- Refer to the PrismaSeT P Active commissioning guide, reference EEXP1G005EN



Commissioning coaching

Description

- The "commissioning" coaching is perfectly suited if you want the help of Schneider Electric to guide you in commissioning of a PrismaSeT P Active switchboard.
- This service is now available via video assistance, so the travel of an expert on site is not necessary.
- Assistance with the commissioning of the first installation of a PrismaSeT P Active switchboard carried out by your company will be free. The following ones will be invoiced according to the current tariff.

Process

- After ordering the service, our teams will contact you to set up an appointment.
- A summary e-mail will then be sent to you, with a reminder 24 hours before your appointment, in order to prepare the prerequisites for commissioning (software, tools, etc.).
- During the coaching, our expert will follow a methodology with a checklist of the actions necessary for commissioning (duration from 15 min to 1 h maximum)

Coaching for the commissioning of a PrismaSeT P Active switchboard

- Provision of technical assistance for the implementation of a PrismaSeT P Active switchboard including software commissioning:
 - EcoStruxure Power Commission (configuration app),
 - EcoStruxure Facility Expert (operating application).
- Reference FSB COACH BAS.

Power circuits

Power circuits

Power cables

Upstream connections

- Cabling of power devices > 630 A uses rigid bars.
- Copper bar drawings can be supplied if the prefabricated connections are not available in the catalogue.

Process

You need to:

- know the position of the current transformers and partitions and check that they can be mounted,
- assemble the busbars with dedicated supports onto the framework,
- tie the cables with "1000 V" insulation onto the device mounting plates (see "Install the cable tie-bars", page 41),
- install tie supports according to fixing distances.

Note:

- The tightening torques for connection to the device terminals are given in the device technical manual.
- To avoid the risk of temperature rise, it is essential to use the screws and bolts delivered with the devices and connections.
- The size of the connections or cables recommended is mentioned in the assembly manuals or on the devices.
- The diameter 8 contact and flat washers must be mounted on hammer screws for Linergy busbars.

Electrical connections checks

Bars and joints

- Control of the isolation distance and creepage lines.

Cables

- Number and section.
- Correspondence between the cable passage holes made in the metal walls and the diameter of the cable glands or cable glands (compliance with the degree of protection), so that the cables do not risk being injured.
- Compatibility of the section of the cables or the terminal with:
 - the cage
 - or the range of the device.
- Quality of cable clamping: it must support their weight and resist the electro-dynamic forces generated by short-circuits.

Tightening

- Check the diameter of the screws and the quality of the tightening of all the electrical connections made on site:
 - either visually, if the screws have been marked,
 - or using a calibrated torque wrench.

Device type	Connection type	
> 630 A power device	Connection by Canalis	Connection by cable
≤ 630 A device	Prefabricated connection to the Linergy LGY busbar	Connection to the flat Linergy BS busbar
≤ 250 A device	Connection by Linergy FC (Polypact) to the Linergy LGY busbar	Connection by Linergy FC (Polypact) to the flat Linergy BS busbar
> 630 A power device	Connection by bars to the Linergy LGY busbar	Connections by bars to the flat Linergy BS busbar
≤ 630 A device	Connection transfer assembly	Universal power supply block for Linergy BW (Powerclip) insulated busbar

Note: For connection to the flat busbar, the panel builder must make the connections himself.

Note: For connection to the flat busbar, the panel builder must make the connections himself.

Note: The Linergy BW 630 A insulated busbar is used in cubicles for distribution over several device rows.

Secondary distribution blocks

Panorama of solutions

You need to comply with connection capacities, stripping lengths, the number of cables connected and use the appropriate tools.

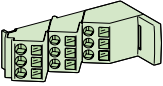
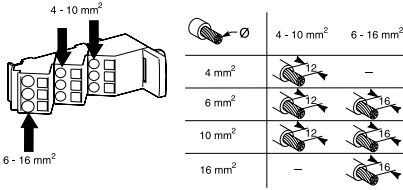
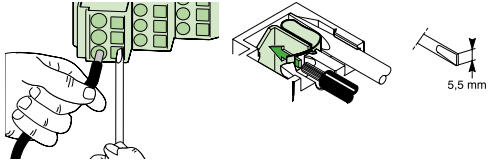
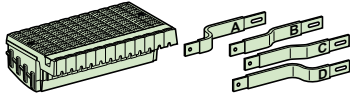
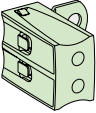
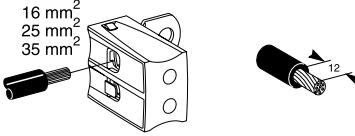
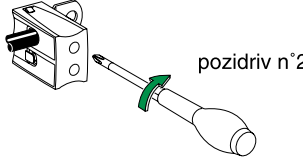
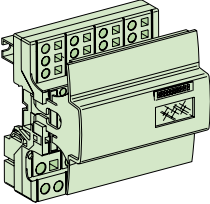
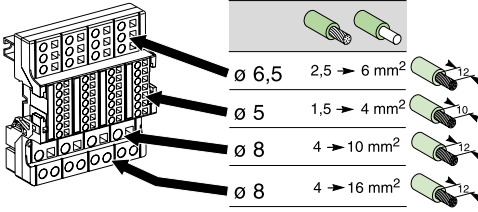
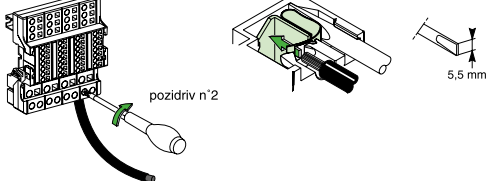
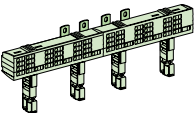
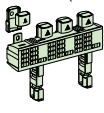
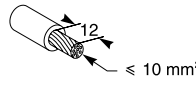
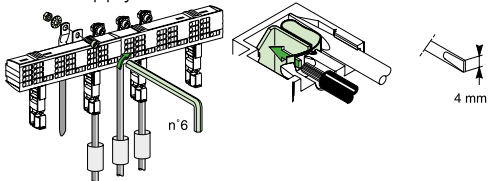
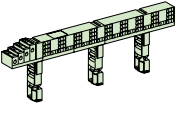
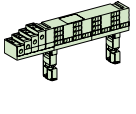
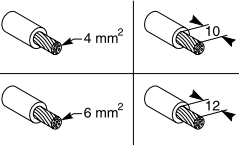
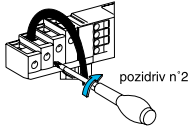
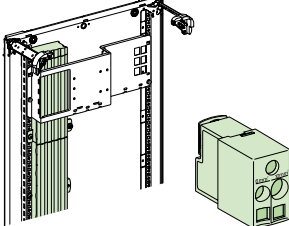
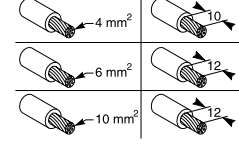
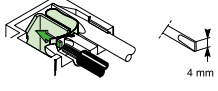
Type	Connection capacity	Connection principle										
Linery DP (Polybloc) 	 <p>4 - 10 mm² 6 - 16 mm²</p> <table border="1"> <tr> <td>4 - 10 mm²</td> <td>6 - 16 mm²</td> </tr> <tr> <td>4 mm²</td> <td>-</td> </tr> <tr> <td>6 mm²</td> <td>16</td> </tr> <tr> <td>10 mm²</td> <td>16</td> </tr> <tr> <td>16 mm²</td> <td>16</td> </tr> </table>	4 - 10 mm ²	6 - 16 mm ²	4 mm ²	-	6 mm ²	16	10 mm ²	16	16 mm ²	16	Distribution  <p>5.5 mm</p>
4 - 10 mm ²	6 - 16 mm ²											
4 mm ²	-											
6 mm ²	16											
10 mm ²	16											
16 mm ²	16											
Linery FC (Polypact) 	4 or 5 ComPacT NSXm according to product 3 or 4 ComPacT NSX	Directly on product terminals										
Additional block for Linery DP NSX 	 <p>16 mm² 25 mm² 35 mm²</p>	 <p>pozidriv n°2</p>										
Linery DX (Distribloc) 	 <p>Ø 6,5 2,5 → 6 mm² Ø 5 1,5 → 4 mm² Ø 8 4 → 10 mm² Ø 8 4 → 16 mm²</p>	Power supply Distribution  <p>pozidriv n°2</p> <p>5.5 mm</p>										
Linery FM (Multiclip) 200 A  160 A (1/2 row)  On the Multiclip 200 A, cable entry is via the bottom only to allow assembly of the insulating covers and production of cable straps.	 <p>≤ 10 mm²</p>	Power supply Distribution  <p>n°6</p> <p>4 mm</p>										
80 A  63 A (1/2 row) 	 <p>4 mm² 10 6 mm² 12</p>	Power supply  <p>pozidriv n°2</p>										
Linery BW tap-off blocks for insulated busbar 	 <p>4 mm² 10 6 mm² 12 10 mm² 12</p>	 <p>4 mm</p>										

! Do not use ferrules with the spring loaded terminals. Each terminal may only take a single wire.

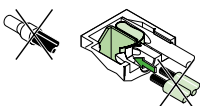

Connection terminal blocks and the earth bars

Install the supports for arrangement of the connection terminal blocks and earth bars.

Note: The connection terminal blocks and earth bars are installed:

- either in the duct that forms a zone that can be completely separated from the devices,
- or in the switchgear zone, at the top or bottom (or on the sides for the earth bar).

Install the terminal blocks

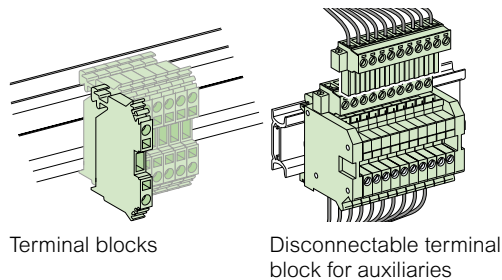

Various modes of installation

- At top or bottom of a cubicle on depth adjusted rails

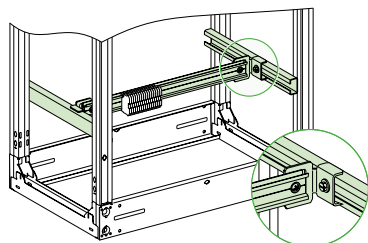

- On modular rail turned using universal angle brackets

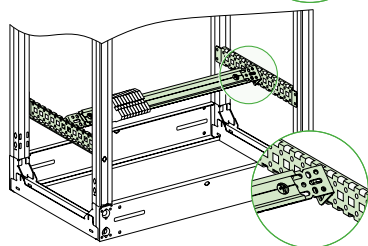

- on a device mounting plate

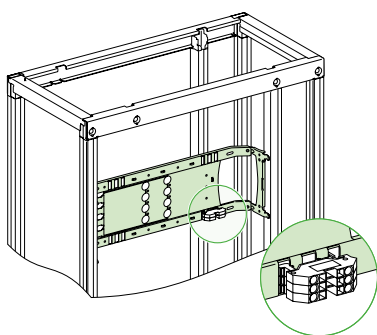

- in a lateral compartment

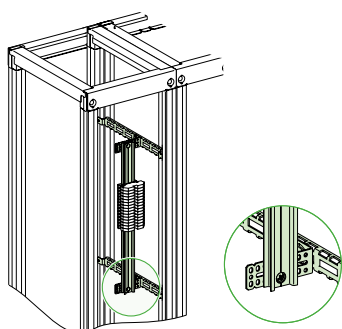

Install the earth bars

Type	Connection capacity	Connection principle
	4 mm ² 6 mm ² 10 mm ² 16 mm ²	 5,5 mm
	 10 ≤ 4 mm ²	 3 mm
	<ul style="list-style-type: none"> • 35 mm² incoming terminals for flexible or rigid cables • 16 mm² outgoing terminals for flexible or rigid cables 	<ul style="list-style-type: none"> • Screw terminals

Install the horizontal and vertical cable straps

• The straps are used to guide the wires. They are easy and quick to implement and can be clipped directly onto the mounting plates.

On mounting plate

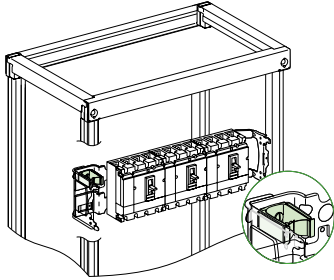

On a modular rail support

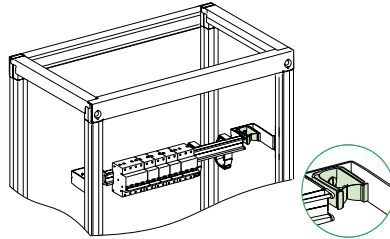

Cover for horizontal cable straps

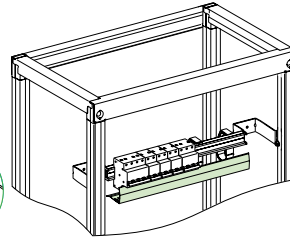

Cover for vertical cable straps

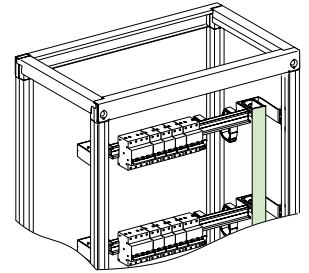

Install the trunking for horizontal or vertical wiring

• The trunking is used to carry wires to the switchgear zone. Trunking is secured:
 - to some mounting plates on specially reserved locations,
 - on the trunking supports by means of clip-on, ¼ turn removable screws.

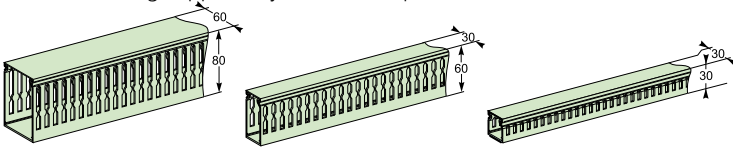

• The Linergy FC (Polypact) distribution block accommodates a trunking as standard to guide the auxiliary wiring of the NSX circuit-breakers that it supplies.

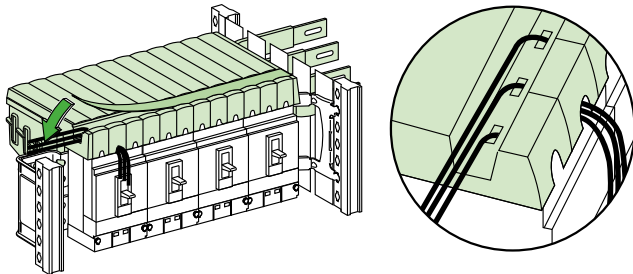

Trunking installed horizontally on the rear of a modular rail

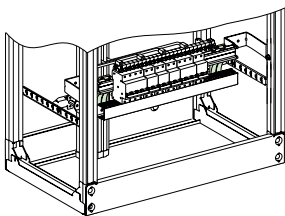

On mounting plate

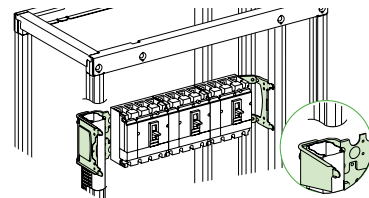

On rail

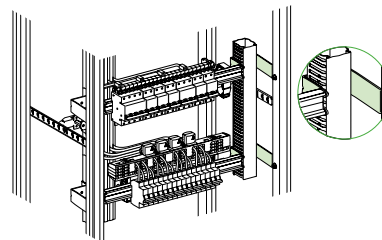

Note: Trunking is assembled onto its support by clipping on, from the front.

Power circuits

Wiring running accessories

Install the cable tie-bars

Longitudinal and lateral cable-tie supports

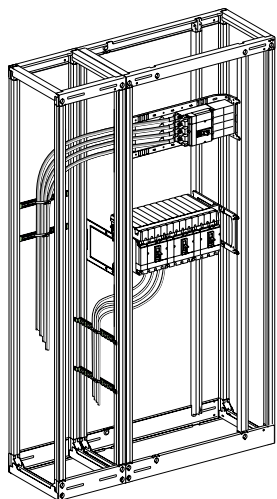

C-shaped cable-tie supports

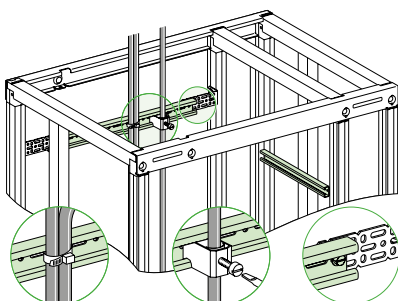

For an L-shaped installation with corner kit for busbars, an additional corner kit can be added for wiring and earth conductor running.

Protection accessories

- Prepare the various protective covers (cut-out, drilling, etc.)
- Fit the various protective covers:
 - upstream and downstream terminal shields are compulsory for all ComPacT NSX circuit-breakers and INS/INV switches with vertical or horizontal mounting,
 - cover for power supply block,
 - connection cover for cable,
 - cover for busbar,
 - tooth-caps, etc.

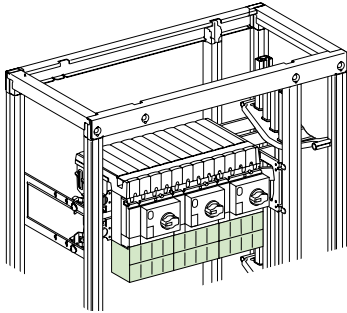

Terminal shields on ComPacT NSX

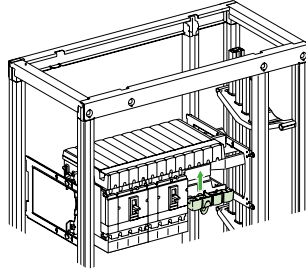

Tooth-caps on Linergy FC

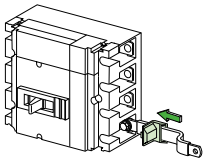

Note: For connection by insulated flexible bars equipped with built-in terminal shields, there is no point equipping ComPacT NSX circuit-breakers with terminal shields.

- Fit the puffing chamber barriers on the MasterPacT MTZ1 or ComPacT NS ≥ 630 A circuit-breakers if bare copper connections are used.

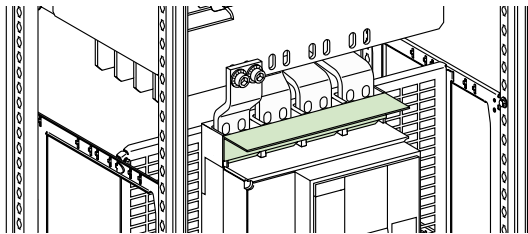

Low power and auxiliary circuits

Low power and auxiliary circuits

Installation

Installing the devices on door or front plate

! For safety reasons, it is forbidden to mount devices on the busbar duct door. We recommend that devices be transferred to the cable duct door.

- Install the partial doors with cut-outs or front plates with cut-outs according to devices to install.

Note: The devices can be installed on conventional plain doors by making a cut-out.

- Install the mounting plates and devices on the doors or front plates.
- Install an earthing braid when the door accommodates non-class 2 devices.

Tip If there is not enough space between the door and the front plates, use the visor.

Metering and human switchboard interface

Analogic ampermeter, push-button... 72x72 or 96x96
 • Interface with plastic mounting plate

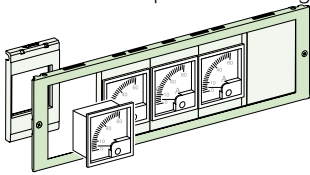

- Inclined visor by 30° with plastic mounting plate

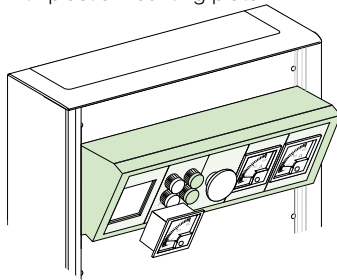

PowerLogic System
 PM5000 Series, PM8000 Series
 72x72 or 96x96
 on mounting plate

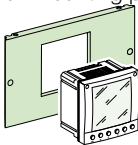

PowerLogic System
 FDM128
 ø 22 mm
 on mounting plate

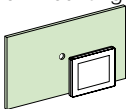

Installing the wiring running accessories

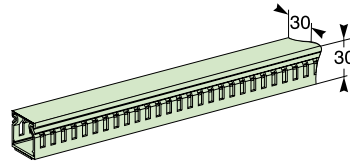

Tip Trunking packing density must not exceed 70 %.

Flexible trunking

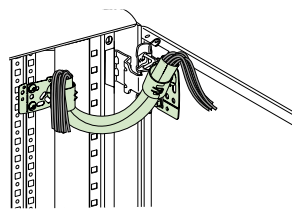

Grommet

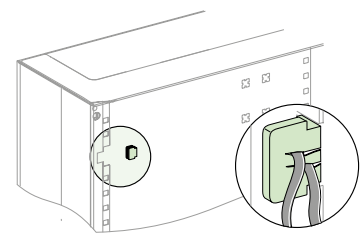

Tip Thoroughly secure cables onto the door to avoid disconnecting the devices when opening. We recommend you use protection devices for wiring through the front panel or to the doors.

Install the trunking and the wire-guide straps

- Install the terminal blocks for auxiliary wiring.
- NB:** Holes are drilled in the mounting plates for rear insertion of cables.

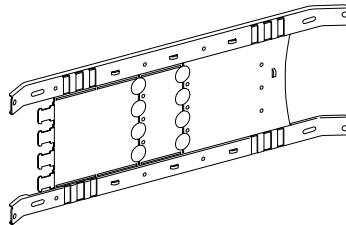

Install the 4P auxiliary bus ducts

- CR no **LVS04203**.

Install the auxiliary disconnectable terminal blocks

- Install the voltage tap-offs at the device exit.

Low power and auxiliary circuits

Cabling

Cabling the auxiliary circuits

6 cabling rules must be applied by the panel builders

Rule no. 1:

- The outgoing conductor and the return conductor must always be adjacent.

Rule no. 2:

- It is preferable to flatten all connections up against equipotential frame structures to benefit from a HF protective effect.

Rule no. 3:

- In the switchboard run the power circuits, control circuits and communication/network circuits in three separate groups. The distance between each group is calculated from the following formula:
radius of the cable with the largest section x 5.
- Only analog, digital and telecommunication signal pairs can be placed right up against one another in the same bundle or laid in the same grouping cable.

Rule no. 4:

- It is not recommended to use the same connector for connections of different families (except for relay, power and power circuits).

Rule no. 5:

- All free conductors in cables must systematically be connected to the chassis frame at both ends (except for analog cables).

Rule no. 6:

- Power cables do not need to be shielded if they are filtered.

Identifying the wires

- In order to simplify on-site connection and maintenance of cubicles, thus avoiding laborious switchboard reworking that could cause errors, you have to identify the wires.
- It is important to obtain customer approval of the marking technique. The marks must be placed at the extremities of the conductors and, if necessary, along their routes.



Separate power cables from auxiliary wires:

Bus cables and the other "fine wiring" cables (connected to auxiliary power supplies for relays, contactor controls, PLC inputs/outputs, etc.) can exist side by side, but must be placed in trunking for separation from power cables.

A bus line is Safety Extra Low Voltage (SELV), thus with double or enhanced insulation with respect to mains. Consequently a bus cable must not touch a bare power bar.

Switchboard inspection

Switchboard inspection

Final factory inspection

Preparation for tests

- Observe the safety rules.
- Vacuum dust from all paintings.
- Remove foreign bodies that are harmful to the proper functioning of the switchboard (falling cables, wires, screws, various parts, tools).

Routine tests

On completion of assembly, the wall-mount or floor-standing enclosure must undergo a variety of inspections and tests. At the very least the 3 routine tests must be carried out as per standard IEC 61439-2 mentioned below:

1st test: overall inspection

- Including examination of cabling.
- Checking connection tightening.
- If necessary, an electrical operating test.

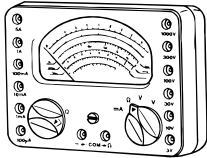

2nd test: checking insulation via a dielectric test

Tip

Disconnect all electronic devices, included wireless panel server, before to make a dielectric test.

- Before switching on the equipment, it is imperative to make an overall insulation measurement.
- In the case of a TNC-type earth connection diagram, disconnect the earth connections, and carry out the insulation measurement only on the phases.
- The test must be carried out using an insulation measuring device with a voltage of at least 500 V DC.

Note: Minimum value of insulation resistance

- The minimum value of the insulation resistance must be equal to 1000 ohms / V.
- If the overall insulation value is low:
 - preheat the switchboard (by resistance, bulb, heat source) to remove moisture for a minimum of 24 hours,
 - again perform an overall insulation measurement.

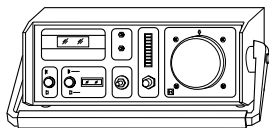

3rd test: checking direct contact protection measures and electrical continuity of protection circuits

- Check the installation of the protections corresponding to the resistance to external influences required:
 - for IP 31: check that the self-adhesive gasket has been fitted on the roof and the deflectors fitted to the bottom ventilation openings,
 - for IP 55: check the placement of the inter-cell joints for the lateral and in-depth associations.
- Make sure that the openings allowing the passage of conductors (inter-cubicle copper bars, incoming and outgoing cables) do not alter the degree of protection of the switchboard.

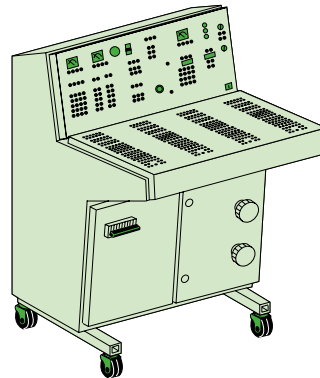

Switchboard inspection

Final factory inspection

Drafting test reports

- It is recommended to draw up a test report relating to the results obtained. There are several forms of documents sometimes drawn up by panel builders themselves.
- It is important to see the following information:
 - customer name,
 - name of the project,
 - switchboard identification,
 - list of tests carried out,
 - date of testing,
 - customer and quality manager visas.
- For more details concerning inspections, consult the technical guide "How to assemble an electrical switchboard" ref. DESW043EN.
- Hereafter, 2 test report models to help you in your document creation process:

PROCES VERBAL DE CONTROLE FINAL
FINAL INSPECTION RECORD

Client/Customer : _____ PV n°/Certif Nr : _____
 Affaire/Project : _____ N° Cde client/Customer ref : _____
 Nom du tableau /Switchboard identification : _____ N° affaire/Job ref : _____
 Type de produit/Product : _____
 Quantite/Qty : _____
 Plan n°/DRWG Nr : _____ Indices/Index : Fin controle Exped.

GAMME DE CONTROLE / CHECKING PROGRAM

1. CONTROLE DE CONFORMITE / CONFORMITY CHECKING

- Les enveloppes/Enclosures
 - L'appareillage/Switchgear
 - Les conducteurs/Conductors

2. VERIFICATIONS MECANIQUES / MECHANICAL CHECKING

3. CONTINUTE ELECTRIQUE DES MASSES MECANIQUES Visuel/Visual
3. EXPOSED CONDUCTIVE PARTS ELECTRICAL CONTINUITY Electrique/Electrical

Ref. appareil de mesure/meter ref _____
 Valeur/Value _____

4. ESSAIS DIELECTRIQUES/DIELECTRIC TESTS Ref. appareil de mesure/Meter Ref _____

Circuit/Circuit	Auxiliaires/Auxiliaries	Puissance/Power
Tension nominale/Nominal voltage	V	
Tension injection/Injection voltage	V	

5. ESSAIS DISOLEMENT/INSULATING TESTS Ref. appareil de mesure/Meter Ref _____

Circuit/Circuit	Auxiliaires/Auxiliaries	Puissance/Power
Tension d'applicat /Applied voltage		
Valeur d'isolement/Insulation value		

6. ESSAIS ELECTRIQUES/ PERFORMANCES ELECT. TESTS

OBSERVATIONS/COMMENTS :

Inspector Client _____ Inspecteur qualite _____ Respons. I.Q.
 Customer representative _____ Quality inspector _____ Quality manager _____
 Date _____ Date _____ Visa _____
 Visa _____ Visa _____

Factory quality inspection
 Check list of checks to be made during the final quality inspection

Make sure that self-checks have been performed throughout the assembly and installation process or validated (e.g. by the line controller).

Control points	Control resources	Final control
Compliance checks		
- Identification & column numbers	- Assembly drawing file	<input checked="" type="checkbox"/>
- Type	- Customer specifications	<input checked="" type="checkbox"/>
- Dimensions		
- Compliance of front panel, block diagram		
- Handling devices		
Visual checks		
- Paint (colour, homogeneity, finishing)	- Visual inspection	<input checked="" type="checkbox"/>
- No scratches and deformations		
Frame, structure		
- Functioning of doors, swivelling front panels	- Operating test	<input checked="" type="checkbox"/>
- Locks (type, functioning)	- Specifications, visual inspection	<input checked="" type="checkbox"/>
- IP degree of protection	- Visual inspection, technical guide	
Switchgear		
- Position	- Visual inspection	<input checked="" type="checkbox"/>
- Fastening	- Visual inspection	<input checked="" type="checkbox"/>
- Characteristics: nominal range, breaking capacity	- Specifications, visual inspection	
- Identification and marking	- Specifications, visual inspection	
- Safety perimeter	- Technical guide	
- Mechanical operation	- Operating test	
- Mechanical indication (test position, connected, etc.)	- Operating test	
- Plugging in and withdrawing procedure	- Operating test	
- Striker pin	- Operating test	
- Accessibility of switchgear	- Visual inspection	
- Ability to connect on terminals or pads	- Visual inspection	
- Accessibility for connection	- Visual inspection	
- Locking, bolting/insp.	- Visual inspection	
Busbars		
- Busbar cross-section	- Technical guide	<input checked="" type="checkbox"/>
- Cooling internal etc: device	- Customer drawings and specifications file	
- Busbar support (fastening device and number)	- Technical guide	
- Marking	- Customer drawings and specifications file	
- Compliance of joint blocks	- Technical guide	
Cables & flexible bars		
- Cross-section and characteristics of conductors	- Technical guide	<input checked="" type="checkbox"/>
- Compliance of installation mode (fastening, sharp edges, etc.)	- Technical guide	
- Auxiliary Power separation	- Assembly and installation guide and communication guide	
- EMC protection	- Assembly and installation guide and communication guide	
Connections		
- Compliance and quality of bolted connections (e.g. covering and fastener type)	- Technical guide	<input checked="" type="checkbox"/>
- Torques and marking		
- Crimping quality		
Protection of persons		
- Earth bar cross-section and fastening)	- Technical guide and assembly technical guide	<input checked="" type="checkbox"/>
- Earthing braids		
- Earthing continuity		
- IP of measuring devices (fastened on doors)		
- Blanking shutters		
- Terminal guards and covers		
- Fastening of protective barriers		
Safety distances		
- Clearance	- Assembly and installation guide and visual inspection	<input checked="" type="checkbox"/>
- Creepage distances	- Installation and assembly guide	<input checked="" type="checkbox"/>
Dielectric check (power circuit)		
- Insulation tester		<input checked="" type="checkbox"/>

to be made
ity inspection

Control resources	Final control
- Megohmmeter	<input checked="" type="checkbox"/>
- Phasing test	
- Electric tests, voltmeter	<input checked="" type="checkbox"/>
- Electric tests, voltmeter	
- Test consoles, injection test bench, etc.	
- Electric tests	
- Technical documentation	
- Customer specifications	
- Packing list	
- Contract terms	

to repeat the process from the beginning
 omer's specifications to the letter

Provide a product of high quality, without defect,
 from the design phase to delivery

Wireless panel server test

Wireless panel server test report is available thanks to EcoStruxure Power Commission App (pour smartphone uniquement).



Note: The LED flashes green for 10 minutes, then orange as long as the switchboard is not connected.

Switchboard inspection

Final factory inspection

Miscellaneous controls

Mechanical locking of the equipment

- Operation.
- Compliance as needed.

Spotting

- From the board: identification plate.
- Power and control conductors.
- Arrivals and departures where applicable.

Presentation

- Visual inspection of the exterior appearance (paint, scratches, ...).
- If necessary, make any alterations.

Cleaning

Interior cleaning

- Dust the inside of the switchboard by vacuuming.
- Check that there are no foreign bodies inside the switchboard (tools, screws) that could be harmful to its proper functioning.

DANGER

RISK OF SHORT-CIRCUITS

Do not clean the inside of the switchboard with a blower, to avoid accumulating shavings or various debris in a live area.

Failure to follow these instructions will result in death, serious injury, or property damage.

Exterior cleaning

- Dust and clean the outside. If necessary, use a neutral solvent which does not risk damaging the paint.
- Touch up paint if necessary.

Partitioning installation

Partitioning Presentation

What are the forms?

- The forms are metal partitions or molded material, removable by using tools or keys, which ensure the protection of operators against direct contact with power conductors when working on low voltage switchboards.
- They also protect internal elements of the switchboard against external aggressions (dust, pests, water ...).
- These forms are graduated from 1 to 4, with indices “a” or “b”. Their use contributes to the level of service continuity required by the user.
- Forms have a cumulative effect (a higher form integrates the characteristics of the forms that precede it).
- The choice of a form is the subject to an agreement between the manufacturer and the user.
- The electrical panel must comply with the degree of protection IP 2X, according to standard IEC 61439-1 & 2.

Forme 2

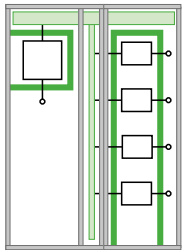

Forme 2a

Forme 3

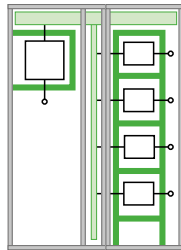

Forme 3a

Forme 4

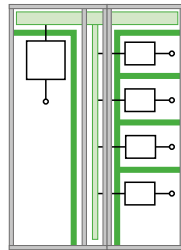

Forme 4a

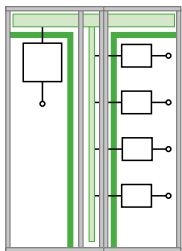

Forme 2b

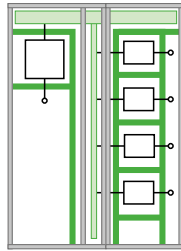

Forme 3b

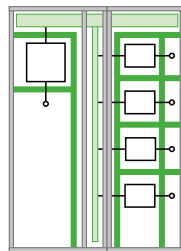

Forme 4b

Partitioning Installation

Installing the incoming unit partitions

• Schneider Electric recommends by default the installation of unit partitions on the incoming devices.

Cable incoming connection

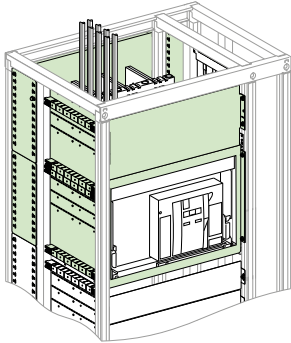

Front cable connection

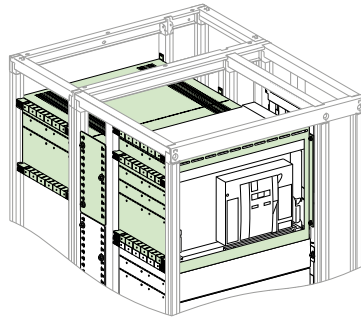

Rear cable connection

Canalis incoming connection

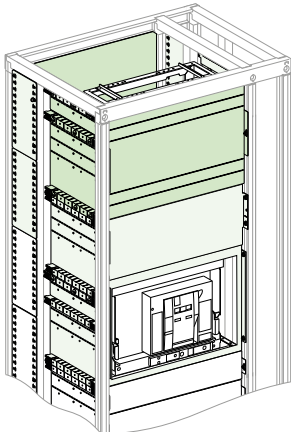

Front Canalis connection

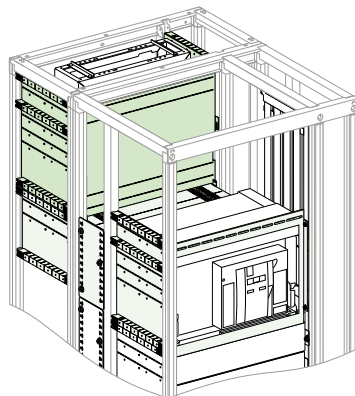

Rear Canalis connection

• Before assembling the partition, remove the pre cut-outs required for cable insertion.

Installing the form 2

Installing the form 2 barriers on the top or bottom horizontal busbar

- Set of two barriers (front and rear), plus a slotted rear panel for efficient natural convection in the switchboard.
- The set can be used to partition horizontal busbars installed at the top or bottom of the cubicle.
- The space required for the busbars is not increased.

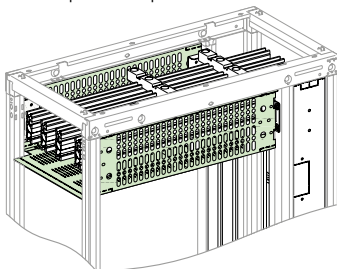

Installing the barriers for the incoming unit connections

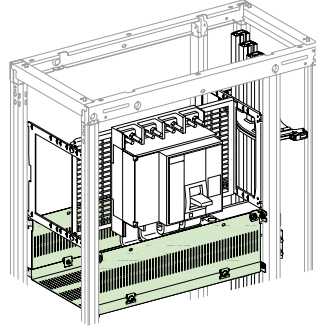

Installing the busbar compartment barriers

- Front and rear barriers:
 - can be installed in the front and rear of the busbar compartment,
 - protect against direct contact with the busbars.
- Form 3 compartment configuration:
 - install the front barrier,
 - install the rear barrier for 600 deep cubicles,
 - in event of insertion of a PEN conductor through the front barrier, remove the pre cut-out provided (compliance with clearances) and fit an insulating plate (Polycarbonate $T^{\circ} > 960^{\circ}\text{C}$) to guarantee IP2X (consult the front barrier assembly manual).

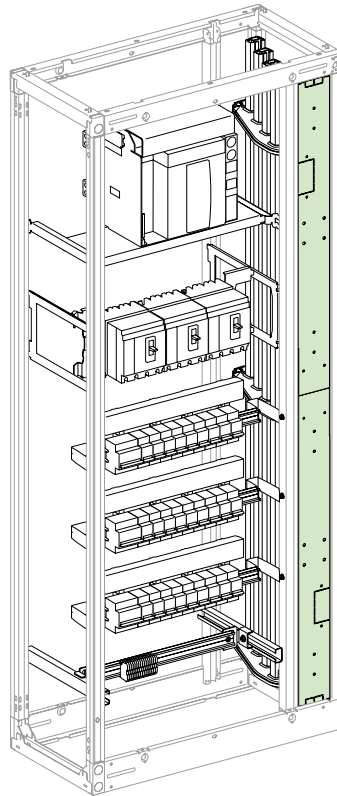

Installing the form 3

Horizontal barriers

- A horizontal metal partition can be used to physically separate functional units from one another.
- It does not take up any useful space in the switchboard

Tip

Before assembling the partition, remove the pre cut-outs required for cable insertion.

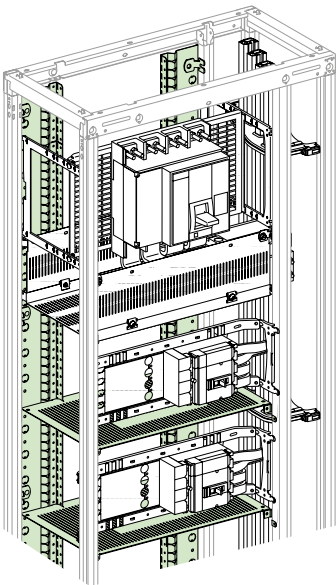

Installing form 4

Backplate and compartments for connection transfer

Form 4a

Front connection

- A backplate (one cat. no. per cubicle) made up to two metal half panels mounted on the rear supports for Form 3 partitions.
- This backplate is not indispensable for 400 mm deep frameworks.
- A plastic gland plate that can be easily cut out (one for each functional unit) and is mounted on the framework.

Rear connection

- A gland plate at the rear of each functional unit. It is connected directly to the rear supports for Form 3 partitions

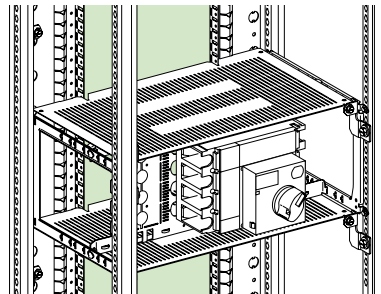

Form 4b

Lateral compartment

- A backplate (one cat. no. per cubicle) made up to two metal half panels mounted on the rear supports for Form 3 partitions.
- This backplate is not indispensable for 400 mm deep frameworks
- A cover with plastic gland plates that can be easily cut out on the side and bottom.

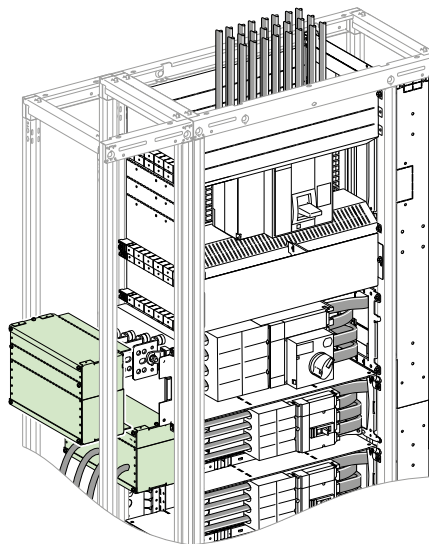

Rear compartment

- It comprises two height-adjustable metal flanges and plastic gland plates that can be easily cut out at the rear and bottom.

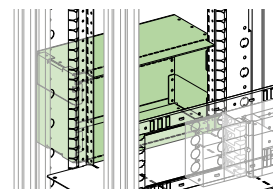

Panels

Panels

Generality

Cleaning the switchboard

Remove dust from the inside using a vacuum cleaner

Tip

Do not use blow cleaning as this may cause shavings and detritus to accumulate in a live area.

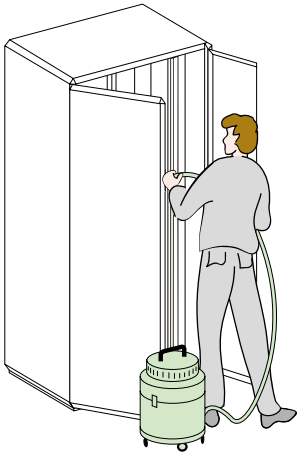

Dust the outside

• Use a neutral dissolvent that will not damage the paint. The switchboard panels can be cleaned using liquid soap, methylated spirits, F oil or isopropyl alcohol.

Visual inspection

• Touch up paintwork if necessary
• Check absence of foreign pieces inside the switchboard (tools, screws and bolts) that could prevent it from operating properly.

Finishing the front panel

- Secure the front plate support frame to the cubicle framework
- Install the markers: fit the label holders
- Install the blanking plates on the front plates

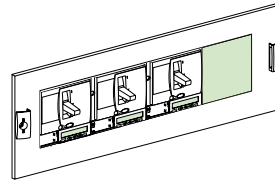

- Install the front plate hinge kit (optional)
CR no **LVS08585**.

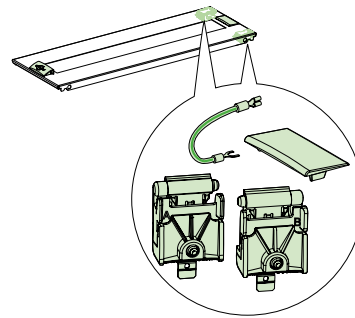

- Fix the adhesive drawing holder CR no **LVS08963**.

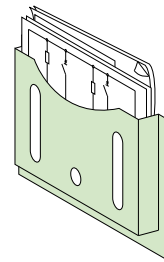

Installing the front panel on the framework

On the front of the switchboard

- A name plate should indicate at least:
 - the name and address of the panel builder,
 - the identity of the project.
- Schneider Electric proposes a switchboard identification plate CR no **LVS08900**.

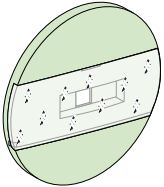

Device marking

- This enables installation users to identify clearly the type of circuits used.
- Marking should be fully legible, durable and properly attached next to the device.
- There are 3 label formats that can be printed or engraved.
- Schneider Electric proposes:
 - adhesive label supplied with a paper label and the transparent cover:

LVS08905 (24 x 180 mm)

LVS08906 (36 x 180 mm)

LVS08903 (24 x 423)

LVS08904 (36 x 432)

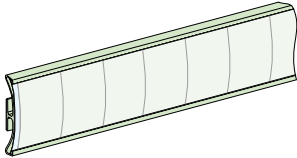

- clip-on labels supplied with a paper label and the transparent cover:

LVS08913 (18 x 35 mm)

LVS08915 (18 x 72 mm)

LVS08917 (25 x 85 mm)

It clips onto the front plate horizontally or vertically and can be screwed to any support (plain door, plain front plate...)

Roof adaptation for Canalis interface

Roof adaptation to 1250 A
ComPacT NS
or MasterPacT MTZ1
circuit breakers

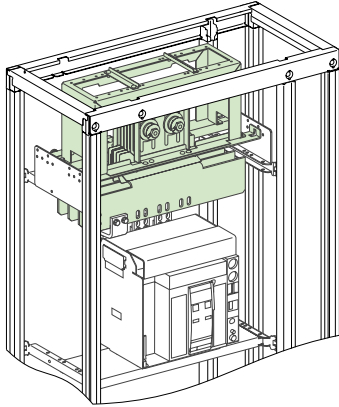

Enclosure 400 mm deep, access through the front

Position of the jointing unit

Circuit breaker		Dimensions ⁽¹⁾ (mm)		
		A	B	C
Fixed, 3P/4P ⁽²⁾	NS800/1250	236	325	160
	MTZ1 08/12	260	325	160
Drawout, 3P/4P ⁽²⁾	NS800/1250	260	325	170
	or MTZ1 08/12			

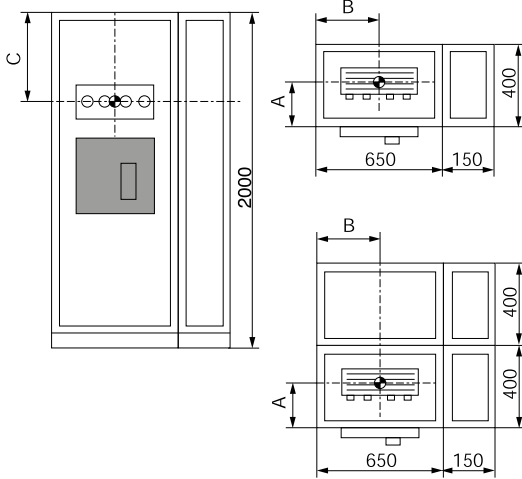

Reference point

Roof adaptation to 800 to 3200 A
MasterPacT MTZ2 circuit breakers

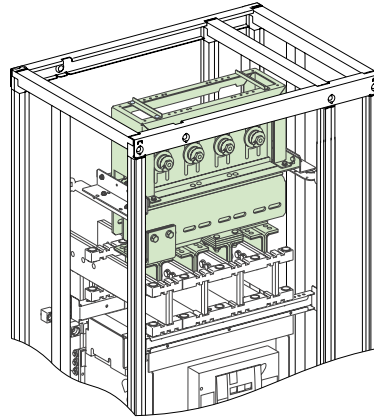

Enclosure 600 mm deep, access through the front

Position of the jointing unit

Circuit breaker		Dimensions ⁽¹⁾ (mm)		
		A	B	C
Fixed, 3P/4P ⁽²⁾	MTZ2 08/16	185	325	264
	MTZ2 20/25	185	325	289
	MTZ2 32	185	325	264
Drawout, 3P/4P ⁽²⁾	MTZ2 08/16	185	344	164
	MTZ2 20/25	185	344	214
	MTZ2 32	185	344	214

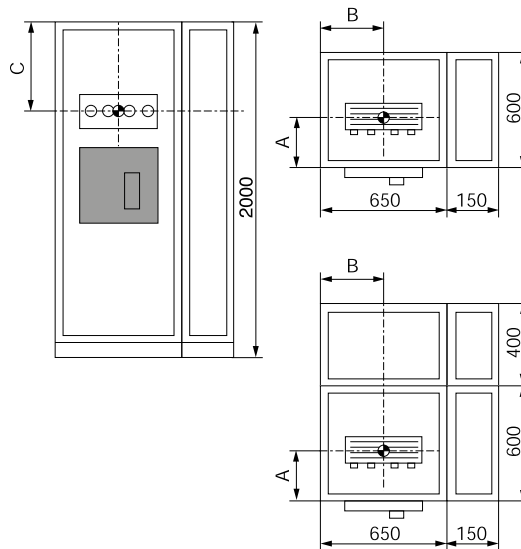

Reference point

(1) Dimensions measured from switchboard framework.
(2) For order refer to catalogue.

Roof adaptation for Canalis interface

Roof adaptation to 1600 A
ComPacT NS
or MasterPacT MTZ1
circuit breakers

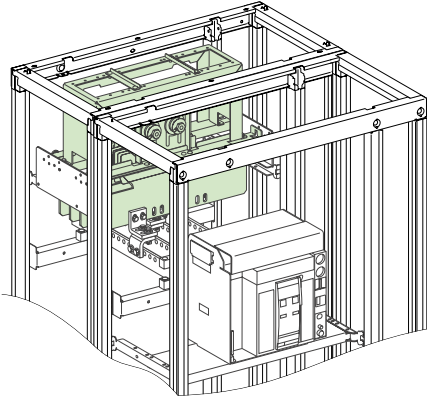

Rear connection (RC)

Two enclosures combined:

- 1 enclosure, 400 mm deep, for the circuit breaker,
- 1 enclosure, 400 mm deep, for the Canalis KT/ switchboard interface.

Position of the jointing unit

Circuit breaker		Dimensions ⁽¹⁾ (mm)		
		A	B	C
Fixed, 3P/4P ⁽²⁾	NS800/1600 or MTZ1 08/16	638	325	160
Drawout, 3P/4P ⁽²⁾	NS800/1600 or MTZ1 08/16	638	325	170

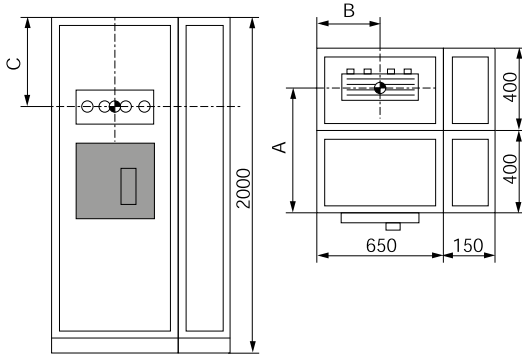

Reference point

Roof adaptation to 800 to 4000 A
MasterPacT MTZ2
circuit breakers

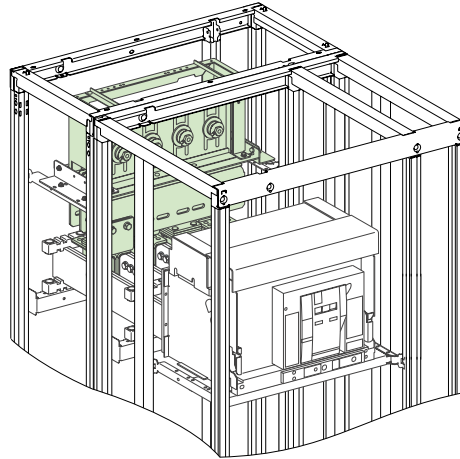

Enclosure 400 mm deep, access through the front

Two enclosures combined:

- 1 enclosure, 600 mm deep, for the circuit breaker,
- 1 enclosure, 400 mm deep, for the Canalis KT/ switchboard interface.

Position of the jointing unit

Circuit breaker		Dimensions ⁽¹⁾ (mm)		
		A	B	C
Fixed, 3P/4P ⁽²⁾	MTZ2 08/16	815	325	264
	MTZ2 20/25	757	325	414
	MTZ2 32	774	325	414
	MTZ2 40	790	325	439
Drawout, 3P/4P ⁽²⁾	MTZ2 08/16	815	317	414
	MTZ2 20/25	815	342	414
	MTZ2 32	815	317	439
	MTZ2 40	790	342	439

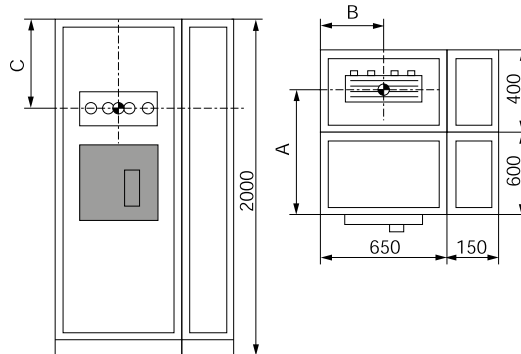

Reference point

Panels

Switchboard panels

Fitting the switchboard panels

Install the gland plates

- Gland plates are used in harsh environments or to isolate the cubicle for insuring IP.

Fit the rear and side panels

Note: For L combinations, there is a specific assembly order: refer to the right-angle kit assembly manual.

- For PrismaSeT P Active, the side panel are delivered with green cover built-in wireless panel server. For other columns, the green bar has to be ordered separately.
- For PrismaSeT P, the green bar has to be ordered separately than side panel.

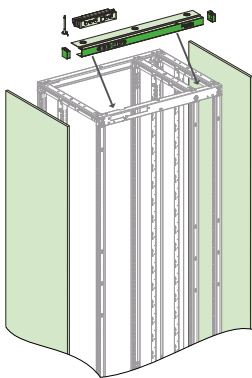

PrismaSeT P Active

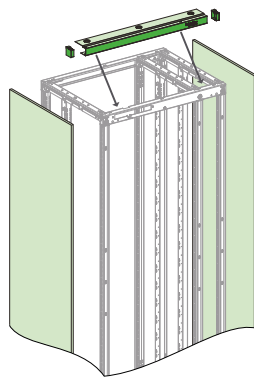

PrismaSeT P

Install the ventilation system, the resistors and the switchboard lighting, if necessary

- Ventilation is used to regulate the temperature inside the switchboard.
- Resistors prevent condensation, corrosion and superficial leakage currents. They maintain a positive temperature in the enclosures and cubicles when external temperatures drop very low.
- The fixed lighting is generally used to illuminate the front of a switchboard. This solution is equipped with a sensor to switch on and switch off the light depending to the door position.

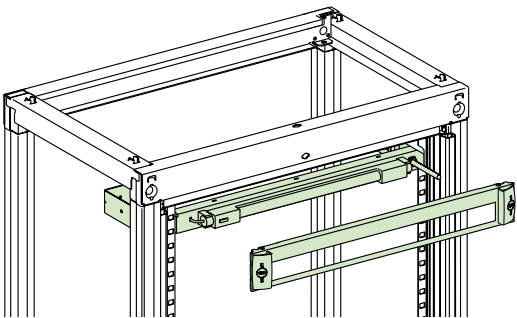

Fit the roof

- For IP31 cubicles, do not forget to fit the gasket. Take care to degrease surfaces thoroughly before sticking on the gaskets.

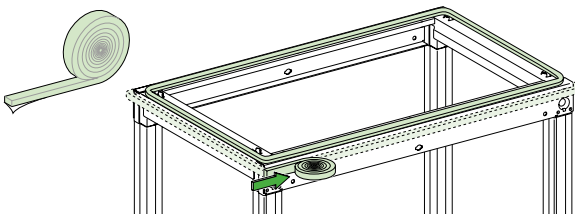

Fit the doors on fixed frames

- PrismaSeT doors can be assembled to be open at right or at left.

Tip

For safety reasons, ensure that the door opening direction will not obstruct on site access to an evacuation corridor or passageway. The door must open in the direction of the evacuation. See PrismaSeT Active Installation Guide, reference DOCA0203EN

- It is advisable to install barrels and inserts before fitting the handle on the door and before mounting on the framework.

Fit the lifting rings for lifting from the top

- Do not forget to fit the plugs.

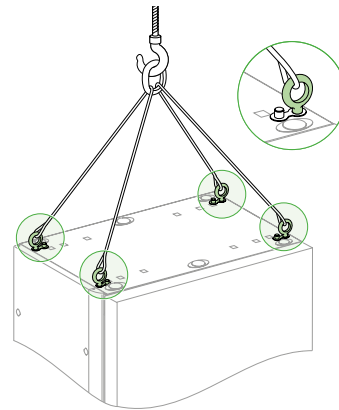

Lifting reinforcement kit

Kit **LVS08722** is recommended for lifting combined cubicles and can be used together with handling base end-pieces **LVS08714** or **LVS08716** for severe transport or handling conditions. Catalogue number **LVS08722** includes 3 reinforcement brackets for 400 or 600 mm deep cubicles and the corresponding mounting hardware..

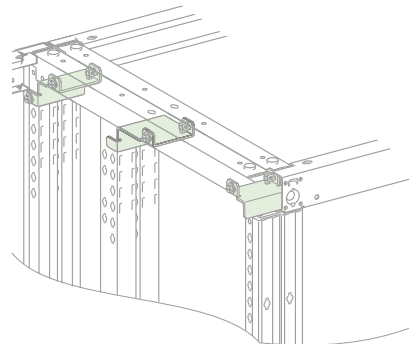

Pack the switchboard

Pack the switchboard

Packing

Delivery preparation

- Uncouple the cubicles electrically and mechanically, if necessary.
- Provide the switchboard with:
 - the necessary accessories (joints, fixing screws, etc.),
 - an installation guide for cubicle on-site coupling,
 - a technical file containing a set of drawings, the device operating manuals and the cubicle assembly manuals.
- Attach the adhesive drawing holder to the back of the door with the technical file.

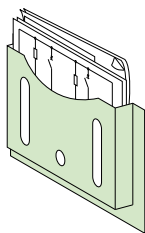

Pack the cubicles

- Ensure cubicle protection for transport, particularly on the surface-mount HSI surfaces.
- Use the stabilisers to increase packing volume and re-use cover panel protections (angle brackets, carton protection, etc.).

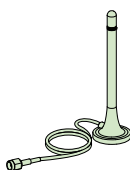

Note: don't forget to deliver the antenna in a separate protective package.



Life Is On



se.com

Schneider Electric SAS
35, rue Joseph Monier
CS 30323
F - 92506 Rueil-Malmaison Cedex
Tél : +33 (0)1 41 29 85 00

© 2021 Schneider Electric. All rights reserved. Life Is On Schneider Electric is a trademark and the property of Schneider Electric SE, its subsidiaries and affiliated companies. Due to possible changes in standards and equipment, the features described in this document in the form of text and images are subject to confirmation by Schneider Electric.

Life Is On - Design and production: Schneider Electric - E. Froger - Photos: Schneider Electric

09/2021
DOCA0204EN-00