

Modicon TM3

Expert I/O Modules

Hardware Guide

03/2020



The information provided in this documentation contains general descriptions and/or technical characteristics of the performance of the products contained herein. This documentation is not intended as a substitute for and is not to be used for determining suitability or reliability of these products for specific user applications. It is the duty of any such user or integrator to perform the appropriate and complete risk analysis, evaluation and testing of the products with respect to the relevant specific application or use thereof. Neither Schneider Electric nor any of its affiliates or subsidiaries shall be responsible or liable for misuse of the information contained herein. If you have any suggestions for improvements or amendments or have found errors in this publication, please notify us.

You agree not to reproduce, other than for your own personal, noncommercial use, all or part of this document on any medium whatsoever without permission of Schneider Electric, given in writing. You also agree not to establish any hypertext links to this document or its content. Schneider Electric does not grant any right or license for the personal and noncommercial use of the document or its content, except for a non-exclusive license to consult it on an "as is" basis, at your own risk. All other rights are reserved.

All pertinent state, regional, and local safety regulations must be observed when installing and using this product. For reasons of safety and to help ensure compliance with documented system data, only the manufacturer should perform repairs to components.

When devices are used for applications with technical safety requirements, the relevant instructions must be followed.

Failure to use Schneider Electric software or approved software with our hardware products may result in injury, harm, or improper operating results.

Failure to observe this information can result in injury or equipment damage.

© 2020 Schneider Electric. All rights reserved.

Table of Contents



	Safety Information	5
	About the Book	7
Part I	TM3 General Overview	13
Chapter 1	TM3 Description	15
	General Description	15
Chapter 2	TM3 Installation	17
2.1	TM3 General Rules for Implementing	18
	Certifications and Standards	18
2.2	TM3 Expansion Module Installation	19
	Installation and Maintenance Requirements	20
	Installation Guidelines	23
	Top Hat Section Rail (DIN rail)	24
	Assembling a Module to a Controller or Receiver Module	27
	Disassembling a Module from a Controller or Receiver Module	29
	Direct Mounting on a Panel Surface	30
2.3	TM3 Electrical Requirements	31
	Wiring Best Practices	31
Part II	TM3 Expert Expansion Modules	39
Chapter 3	TM3XTYS4 TeSys Module	41
	Environmental Characteristics	42
	TM3XTYS4 Presentation	45
	TM3XTYS4 Characteristics	51
	TM3XTYS4 Wiring Diagram	54
Chapter 4	TM3XFHSC202 / TM3XFHSC202G Module	57
	Environmental Characteristics	58
	TM3XFHSC202 / TM3XFHSC202G Presentation	61
	TM3XFHSC202 / TM3XFHSC202G Characteristics	63
	TM3XFHSC202 / TM3XFHSC202G Wiring Diagram	67

Chapter 5	TM3XHSC202 / TM3XHSC202G Module	71
	Environmental Characteristics	72
	TM3XHSC202 / TM3XHSC202G Presentation	75
	TM3XHSC202 / TM3XHSC202G Characteristics	77
	TM3XHSC202 / TM3XHSC202G Wiring Diagram	81
Glossary	85
Index	87

Safety Information



Important Information

NOTICE

Read these instructions carefully, and look at the equipment to become familiar with the device before trying to install, operate, service, or maintain it. The following special messages may appear throughout this documentation or on the equipment to warn of potential hazards or to call attention to information that clarifies or simplifies a procedure.



The addition of this symbol to a “Danger” or “Warning” safety label indicates that an electrical hazard exists which will result in personal injury if the instructions are not followed.



This is the safety alert symbol. It is used to alert you to potential personal injury hazards. Obey all safety messages that follow this symbol to avoid possible injury or death.

DANGER

DANGER indicates a hazardous situation which, if not avoided, **will result in death** or serious injury.

WARNING

WARNING indicates a hazardous situation which, if not avoided, **could result in death** or serious injury.

CAUTION

CAUTION indicates a hazardous situation which, if not avoided, **could result** in minor or moderate injury.

NOTICE

NOTICE is used to address practices not related to physical injury.

PLEASE NOTE

Electrical equipment should be installed, operated, serviced, and maintained only by qualified personnel. No responsibility is assumed by Schneider Electric for any consequences arising out of the use of this material.

A qualified person is one who has skills and knowledge related to the construction and operation of electrical equipment and its installation, and has received safety training to recognize and avoid the hazards involved.

QUALIFICATION OF PERSONNEL

Only appropriately trained persons who are familiar with and understand the contents of this manual and all other pertinent product documentation are authorized to work on and with this product.

The qualified person must be able to detect possible hazards that may arise from parameterization, modifying parameter values and generally from mechanical, electrical, or electronic equipment. The qualified person must be familiar with the standards, provisions, and regulations for the prevention of industrial accidents, which they must observe when designing and implementing the system.

INTENDED USE

The products described or affected by this document, together with software, accessories, and options, are expansion modules, intended for industrial use according to the instructions, directions, examples, and safety information contained in the present document and other supporting documentation.

The product may only be used in compliance with all applicable safety regulations and directives, the specified requirements, and the technical data.

Prior to using the product, you must perform a risk assessment in view of the planned application. Based on the results, the appropriate safety-related measures must be implemented.

Since the product is used as a component in an overall machine or process, you must ensure the safety of persons by means of the design of this overall system.

Operate the product only with the specified cables and accessories. Use only genuine accessories and spare parts.

Any use other than the use explicitly permitted is prohibited and can result in unanticipated hazards.

About the Book



At a Glance

Document Scope

This guide describes the hardware implementation of TM3 expert modules. It provides the parts description, characteristics, wiring diagrams, and installation details for TM3 expert modules.

Validity Note

This document has been updated for the release of EcoStruxure™ Machine Expert V1.2.2.

The technical characteristics of the devices described in the present document also appear online. To access the information online, go to the Schneider Electric home page

<https://www.se.com/ww/en/download/>.

The characteristics that are described in the present document should be the same as those characteristics that appear online. In line with our policy of constant improvement, we may revise content over time to improve clarity and accuracy. If you see a difference between the document and online information, use the online information as your reference.

For product compliance and environmental information (RoHS, REACH, PEP, EOLI, etc.), go to www.schneider-electric.com/green-premium.

Related Documents

Title of Documentation	Reference Number
Modicon TM3 Expansion Modules Configuration - Programming Guide (EcoStruxure Machine Expert - Basic)	EIO0000003345 (ENG) EIO0000003346 (FRA) EIO0000003347 (GER) EIO0000003348 (SPA) EIO0000003349 (ITA) EIO0000003350 (CHS) EIO0000003351 (POR) EIO0000003352 (TUR)
Modicon TM3 Expansion Modules Configuration - Programming Guide (EcoStruxure Machine Expert)	EIO0000003119 (ENG) EIO0000003120 (FRA) EIO0000003121 (GER) EIO0000003122 (SPA) EIO0000003123 (ITA) EIO0000003124 (CHS)

Title of Documentation	Reference Number
Modicon M221 Logic Controller - Hardware Guide	EIO0000003313 (ENG) EIO0000003314 (FRA) EIO0000003315 (GER) EIO0000003316 (SPA) EIO0000003317 (ITA) EIO0000003318 (CHS) EIO0000003319 (POR) EIO0000003320 (TUR)
Modicon M241 Logic Controller - Hardware Guide	EIO0000003083 (ENG) EIO0000003084 (FRA) EIO0000003085 (GER) EIO0000003086 (SPA) EIO0000003087 (ITA) EIO0000003088 (CHS)
Modicon M251 Logic Controller - Hardware Guide	EIO0000003101 (ENG) EIO0000003102 (FRA) EIO0000003103 (GER) EIO0000003104 (SPA) EIO0000003105 (ITA) EIO0000003106 (CHS)
TM3 Expert I/O Modules - Instruction sheet	HRB59608

You can download these technical publications and other technical information from our website at <https://www.se.com/ww/en/download/> .

Product Related Information

DANGER

HAZARD OF ELECTRIC SHOCK, EXPLOSION OR ARC FLASH

- Disconnect all power from all equipment including connected devices prior to removing any covers or doors, or installing or removing any accessories, hardware, cables, or wires except under the specific conditions specified in the appropriate hardware guide for this equipment.
- Always use a properly rated voltage sensing device to confirm the power is off where and when indicated.
- Replace and secure all covers, accessories, hardware, cables, and wires and confirm that a proper ground connection exists before applying power to the unit.
- Use only the specified voltage when operating this equipment and any associated products.

Failure to follow these instructions will result in death or serious injury.

DANGER

POTENTIAL FOR EXPLOSION

- Only use this equipment in non-hazardous locations, or in locations that comply with Class I, Division 2, Groups A, B, C and D.
- Do not substitute components which would impair compliance to Class I, Division 2.
- Do not connect or disconnect equipment unless power has been removed or the location is known to be non-hazardous.
- Do not use the USB port(s), if so equipped, unless the location is known to be non-hazardous.

Failure to follow these instructions will result in death or serious injury.

WARNING

LOSS OF CONTROL

- The designer of any control scheme must consider the potential failure modes of control paths and, for certain critical control functions, provide a means to achieve a safe state during and after a path failure. Examples of critical control functions are emergency stop and overtravel stop, power outage and restart.
- Separate or redundant control paths must be provided for critical control functions.
- System control paths may include communication links. Consideration must be given to the implications of unanticipated transmission delays or failures of the link.
- Observe all accident prevention regulations and local safety guidelines.¹
- Each implementation of this equipment must be individually and thoroughly tested for proper operation before being placed into service.

Failure to follow these instructions can result in death, serious injury, or equipment damage.

¹ For additional information, refer to NEMA ICS 1.1 (latest edition), "Safety Guidelines for the Application, Installation, and Maintenance of Solid State Control" and to NEMA ICS 7.1 (latest edition), "Safety Standards for Construction and Guide for Selection, Installation and Operation of Adjustable-Speed Drive Systems" or their equivalent governing your particular location.

WARNING

UNINTENDED EQUIPMENT OPERATION

- Only use software approved by Schneider Electric for use with this equipment.
- Update your application program every time you change the physical hardware configuration.

Failure to follow these instructions can result in death, serious injury, or equipment damage.

Terminology Derived from Standards

The technical terms, terminology, symbols and the corresponding descriptions in this manual, or that appear in or on the products themselves, are generally derived from the terms or definitions of international standards.

In the area of functional safety systems, drives and general automation, this may include, but is not limited to, terms such as *safety*, *safety function*, *safe state*, *fault*, *fault reset*, *malfunction*, *failure*, *error*, *error message*, *dangerous*, etc.

Among others, these standards include:

Standard	Description
IEC 61131-2:2007	Programmable controllers, part 2: Equipment requirements and tests.
ISO 13849-1:2015	Safety of machinery: Safety related parts of control systems. General principles for design.
EN 61496-1:2013	Safety of machinery: Electro-sensitive protective equipment. Part 1: General requirements and tests.
ISO 12100:2010	Safety of machinery - General principles for design - Risk assessment and risk reduction
EN 60204-1:2006	Safety of machinery - Electrical equipment of machines - Part 1: General requirements
ISO 14119:2013	Safety of machinery - Interlocking devices associated with guards - Principles for design and selection
ISO 13850:2015	Safety of machinery - Emergency stop - Principles for design
IEC 62061:2015	Safety of machinery - Functional safety of safety-related electrical, electronic, and electronic programmable control systems
IEC 61508-1:2010	Functional safety of electrical/electronic/programmable electronic safety-related systems: General requirements.
IEC 61508-2:2010	Functional safety of electrical/electronic/programmable electronic safety-related systems: Requirements for electrical/electronic/programmable electronic safety-related systems.
IEC 61508-3:2010	Functional safety of electrical/electronic/programmable electronic safety-related systems: Software requirements.
IEC 61784-3:2016	Industrial communication networks - Profiles - Part 3: Functional safety fieldbuses - General rules and profile definitions.
2006/42/EC	Machinery Directive
2014/30/EU	Electromagnetic Compatibility Directive
2014/35/EU	Low Voltage Directive

In addition, terms used in the present document may tangentially be used as they are derived from other standards such as:

Standard	Description
IEC 60034 series	Rotating electrical machines
IEC 61800 series	Adjustable speed electrical power drive systems
IEC 61158 series	Digital data communications for measurement and control – Fieldbus for use in industrial control systems

Finally, the term *zone of operation* may be used in conjunction with the description of specific hazards, and is defined as it is for a *hazard zone* or *danger zone* in the *Machinery Directive (2006/42/EC)* and *ISO 12100:2010*.

NOTE: The aforementioned standards may or may not apply to the specific products cited in the present documentation. For more information concerning the individual standards applicable to the products described herein, see the characteristics tables for those product references.

Part I

TM3 General Overview

What Is in This Part?

This part contains the following chapters:

Chapter	Chapter Name	Page
1	TM3 Description	15
2	TM3 Installation	17

Chapter 1

TM3 Description

General Description

TM3 Expert Module

The following table shows the TM3 expert expansion modules, with corresponding terminal types:

Reference	Description	Terminal Type / Pitch
TM3XTYS4 (<i>see page 41</i>)	TeSys module	4 front connectors RJ-45 1 removable power supply connector / 5.08 mm
TM3XFHSC202 (<i>see page 57</i>)	High Speed Counting (HSC) module with events	Removable screw terminal blocks / 3.81 mm
TM3XFHSC202G (<i>see page 57</i>)	High Speed Counting (HSC) module with events	Removable spring terminal blocks / 3.81 mm
TM3XHSC202 (<i>see page 71</i>)	High Speed Counting (HSC) module	Removable screw terminal blocks / 3.81 mm
TM3XHSC202G (<i>see page 71</i>)	High Speed Counting (HSC) module	Removable spring terminal blocks / 3.81 mm

Accessories

Reference	Description	Use	Quantity
NSYTRAABV35	End brackets	Helps secure the logic controller or receiver module and their expansion modules on a top hat section rail (DIN rail).	1
TM2XMTGB	Grounding Bar	Connects the cable shield and the module to the functional ground	1
TM200RSRCMC	Shielding take-up clip	Mounts and connects the ground to the cable shielding.	25 pack
TMAM2	Mounting Kit	Mounts the controller and I/O modules directly to a flat, vertical panel.	1

Connector and Cables

Use one of the TeSys cables to connect a TM3XTYS4 module to your TeSys system:

Reference	Description	Use	Length
LU9 R03	Connection cables equipped with an RJ45 connector at both ends.	Connects the TM3XTYS4 module to the TeSys system.	0.3 m (0.98 ft)
LU9 R10			1 m (3.28 ft)
LU9 R30			3 m (9.84 ft)

Chapter 2

TM3 Installation

What Is in This Chapter?

This chapter contains the following sections:

Section	Topic	Page
2.1	TM3 General Rules for Implementing	18
2.2	TM3 Expansion Module Installation	19
2.3	TM3 Electrical Requirements	31

Section 2.1

TM3 General Rules for Implementing

Certifications and Standards

Introduction

The TM3 expansion modules are designed to conform to the main national and international standards concerning electronic industrial control devices:

- IEC/EN 61131-2
- UL 61010-1
- UL 61010-2-201
- CSA 22.2 n° 142

For the TM3XTYS4 module:

- CSA 22.2 n° 213

The TM3X•HSC• have obtained the following conformity marks:

- CE
- cULus
- EAC
- RCM

The TM3XTYS4 have obtained the following conformity marks:

- CE
- UL
- CSA

NOTE: Refer to the product marking for the last certification.

For product compliance and environmental information (RoHS, REACH, PEP, EOLI, etc.), go to www.schneider-electric.com/green-premium.

Section 2.2

TM3 Expansion Module Installation

What Is in This Section?

This section contains the following topics:

Topic	Page
Installation and Maintenance Requirements	20
Installation Guidelines	23
Top Hat Section Rail (DIN rail)	24
Assembling a Module to a Controller or Receiver Module	27
Disassembling a Module from a Controller or Receiver Module	29
Direct Mounting on a Panel Surface	30

Installation and Maintenance Requirements

Before Starting

Read and understand this chapter before beginning the installation of your system.

The use and application of the information contained herein require expertise in the design and programming of automated control systems. Only you, the user, machine builder or integrator, can be aware of all the conditions and factors present during installation and setup, operation, and maintenance of the machine or process, and can therefore determine the automation and associated equipment and the related safeties and interlocks which can be effectively and properly used. When selecting automation and control equipment, and any other related equipment or software, for a particular application, you must also consider any applicable local, regional or national standards and/or regulations.

Pay particular attention in conforming to any safety information, different electrical requirements, and normative standards that would apply to your machine or process in the use of this equipment.

Disconnecting Power

All options and modules should be assembled and installed before installing the control system on a mounting rail, onto a mounting plate or in a panel. Remove the control system from its mounting rail, mounting plate or panel before disassembling the equipment.

DANGER

HAZARD OF ELECTRIC SHOCK, EXPLOSION OR ARC FLASH

- Disconnect all power from all equipment including connected devices prior to removing any covers or doors, or installing or removing any accessories, hardware, cables, or wires except under the specific conditions specified in the appropriate hardware guide for this equipment.
- Always use a properly rated voltage sensing device to confirm the power is off where and when indicated.
- Replace and secure all covers, accessories, hardware, cables, and wires and confirm that a proper ground connection exists before applying power to the unit.
- Use only the specified voltage when operating this equipment and any associated products.

Failure to follow these instructions will result in death or serious injury.

Programming Considerations

WARNING

UNINTENDED EQUIPMENT OPERATION

- Only use software approved by Schneider Electric for use with this equipment.
- Update your application program every time you change the physical hardware configuration.

Failure to follow these instructions can result in death, serious injury, or equipment damage.

Operating Environment

In addition to the **Environmental Characteristics**, refer to **Product Related Information** in the beginning of the present document for important information regarding installation in hazardous locations for this specific equipment.

WARNING

UNINTENDED EQUIPMENT OPERATION

Install and operate this equipment according to the conditions described in the Environmental Characteristics.

Failure to follow these instructions can result in death, serious injury, or equipment damage.

Installation Considerations

WARNING

UNINTENDED EQUIPMENT OPERATION

- Use appropriate safety interlocks where personnel and/or equipment hazards exist.
- Install and operate this equipment in an enclosure appropriately rated for its intended environment and secured by a keyed or tooled locking mechanism.
- Use the sensor and actuator power supplies only for supplying power to the sensors or actuators connected to the module.
- Power line and output circuits must be wired and fused in compliance with local and national regulatory requirements for the rated current and voltage of the particular equipment.
- Do not use this equipment in safety-critical machine functions unless the equipment is otherwise designated as functional safety equipment and conforming to applicable regulations and standards.
- Do not disassemble, repair, or modify this equipment.
- Do not connect any wiring to reserved, unused connections, or to connections designated as No Connection (N.C.).

Failure to follow these instructions can result in death, serious injury, or equipment damage.

NOTE: JDYX2 or JDYX8 fuse types are UL-recognized and CSA approved.

Installation Guidelines

Introduction

TM3 expansion modules are assembled by connecting them to a logic controller or receiver module.

The logic controller or receiver module and their expansion modules can be installed on a top hat section rail (DIN rail).

Mounting Position and Minimum Clearances

The mounting position and minimum clearances of the expansion modules must conform with the rules defined for the appropriate hardware system. Refer to the *Installation chapter* in the *Controller Hardware* documentation for your specific controller.

WARNING

UNINTENDED EQUIPMENT OPERATION

- Place devices dissipating the most heat at the top of the cabinet and ensure adequate ventilation.
- Avoid placing this equipment next to or above devices that might cause overheating.
- Install the equipment in a location providing the minimum clearances from all adjacent structures and equipment as directed in this document.
- Install all equipment in accordance with the specifications in the related documentation.

Failure to follow these instructions can result in death, serious injury, or equipment damage.

Top Hat Section Rail (DIN rail)

Dimensions of Top Hat Section Rail (DIN Rail)

You can mount the controller or receiver and their expansions on a 35 mm (1.38 in.) top hat section rail (DIN rail). The DIN rail can be attached to a smooth mounting surface or suspended from a EIA rack or mounted in a NEMA cabinet.

Symmetric Top Hat Section Rails (DIN Rail)

The following illustration and table indicate the references of the top hat section rails (DIN rail) for the wall-mounting range:

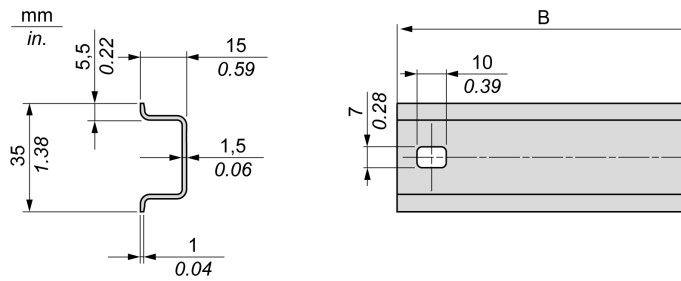

Reference	Type	Rail Length (B)
NSYS DR50A	A	450 mm (17.71 in.)
NSYS DR60A	A	550 mm (21.65 in.)
NSYS DR80A	A	750 mm (29.52 in.)
NSYS DR100A	A	950 mm (37.40 in.)

The following illustration and table indicate the references of the symmetric top hat section rails (DIN rail) for the metal enclosure range:

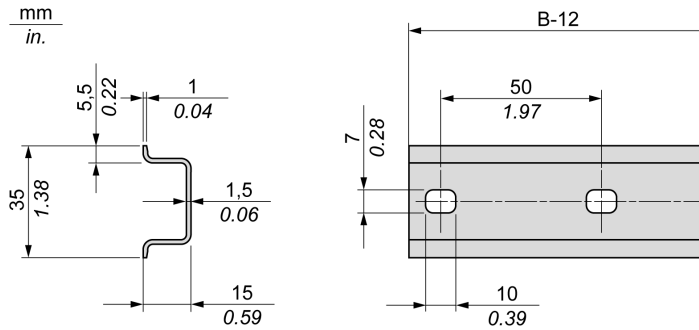

Reference	Type	Rail Length (B-12 mm)
NSYSDR60	A	588 mm (23.15 in.)
NSYSDR80	A	788 mm (31.02 in.)
NSYSDR100	A	988 mm (38.89 in.)
NSYSDR120	A	1188 mm (46.77 in.)

The following illustration and table indicate the references of the symmetric top hat section rails (DIN rail) of 2000 mm (78.74 in.):

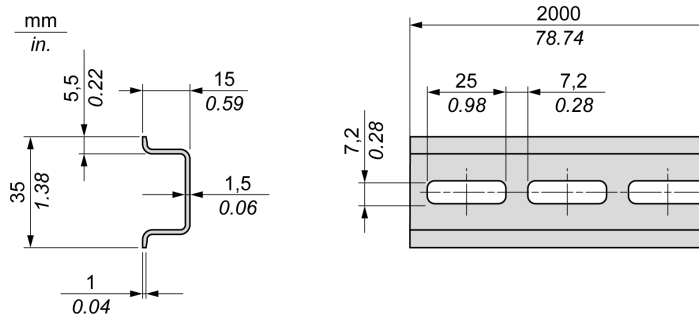

Reference	Type	Rail Length
NSYSDR200 ¹	A	2000 mm (78.74 in.)
NSYSDR200D ²	A	
1 Unperforated galvanized steel 2 Perforated galvanized steel		

Double-Profile Top Hat Section Rails (DIN rail)

The following illustration and table indicate the references of the double-profile top hat section rails (DIN rails) for the wall-mounting range:

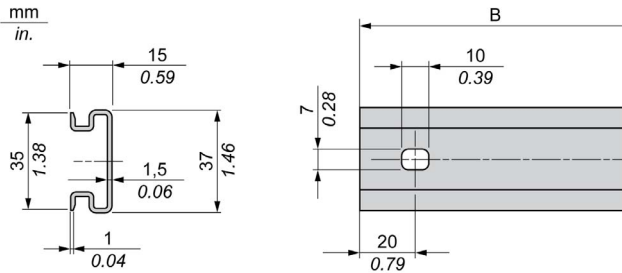

Reference	Type	Rail Length (B)
NSYDPR25	W	250 mm (9.84 in.)
NSYDPR35	W	350 mm (13.77 in.)
NSYDPR45	W	450 mm (17.71 in.)
NSYDPR55	W	550 mm (21.65 in.)
NSYDPR65	W	650 mm (25.60 in.)
NSYDPR75	W	750 mm (29.52 in.)

The following illustration and table indicate the references of the double-profile top hat section rails (DIN rail) for the floor-standing range:

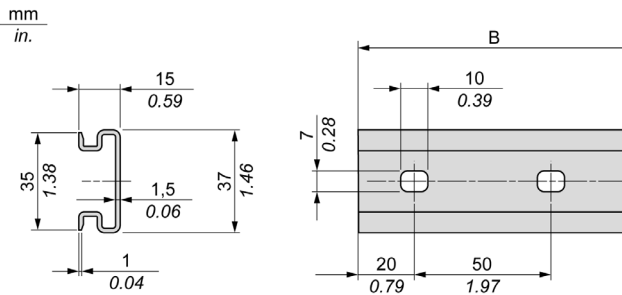

Reference	Type	Rail Length (B)
NSYDPR60	F	588 mm (23.15 in.)
NSYDPR80	F	788 mm (31.02 in.)
NSYDPR100	F	988 mm (38.89 in.)
NSYDPR120	F	1188 mm (46.77 in.)

Assembling a Module to a Controller or Receiver Module

Introduction

This section describes how to assemble an expansion module to a controller, Receiver module or other modules.

DANGER

HAZARD OF ELECTRIC SHOCK, EXPLOSION OR ARC FLASH

- Disconnect all power from all equipment including connected devices prior to removing any covers or doors, or installing or removing any accessories, hardware, cables, or wires except under the specific conditions specified in the appropriate hardware guide for this equipment.
- Always use a properly rated voltage sensing device to confirm the power is off where and when indicated.
- Replace and secure all covers, accessories, hardware, cables, and wires and confirm that a proper ground connection exists before applying power to the unit.
- Use only the specified voltage when operating this equipment and any associated products.

Failure to follow these instructions will result in death or serious injury.

After connecting new modules to the controller, either directly or through a transmitter/receiver, update and reupload your application program before placing the system back in service. If you do not revise your application program to reflect the addition of new modules, I/O located on the expansion bus may no longer operate normally.

WARNING

UNINTENDED EQUIPMENT OPERATION

- Only use software approved by Schneider Electric for use with this equipment.
- Update your application program every time you change the physical hardware configuration.

Failure to follow these instructions can result in death, serious injury, or equipment damage.

Assembling a Module to a Controller or Receiver Module

The following procedure shows how to assemble a controller or receiver module and a module together.

Step	Action
1	Remove all power and dismount any existing controller I/O assembly from its DIN mounting.
2	Remove the expansion connector sticker from the controller or the outermost installed expansion module.
3	Verify that the locking device on the new module is in the upper position.
4	Align the internal bus connector on the left side of the module with the internal bus connector on the right side of the controller, Receiver module or expansion module.
5	Press the new module towards the controller, Receiver module or expansion module until it is securely in place.
6	Push down the locking device on the top of the new module to lock it to the controller, Receiver module or previously installed expansion module.

Disassembling a Module from a Controller or Receiver Module

Introduction

This section describes how to disassemble a module from a controller or receiver module.



HAZARD OF ELECTRIC SHOCK, EXPLOSION OR ARC FLASH

- Disconnect all power from all equipment including connected devices prior to removing any covers or doors, or installing or removing any accessories, hardware, cables, or wires except under the specific conditions specified in the appropriate hardware guide for this equipment.
- Always use a properly rated voltage sensing device to confirm the power is off where and when indicated.
- Replace and secure all covers, accessories, hardware, cables, and wires and confirm that a proper ground connection exists before applying power to the unit.
- Use only the specified voltage when operating this equipment and any associated products.

Failure to follow these instructions will result in death or serious injury.

Disassembling a Module from a Controller or Receiver Module

The following procedure describes how to disassemble a module from a controller or receiver module.

Step	Action
1	Remove all power from the control system.
2	Dismount the assembled controller and modules from the mounting rail.
3	Push up the locking device from the bottom of the module to disengage it from the controller or receiver module.
4	Pull apart module from the controller or receiver module.

Direct Mounting on a Panel Surface

Overview

This section shows how to install the TM3 expansion module using the Panel Mounting Kit. This section also provides mounting hole layout for all modules.

Installing the Panel Mount Kit

The following procedure shows how to install a mounting strip:

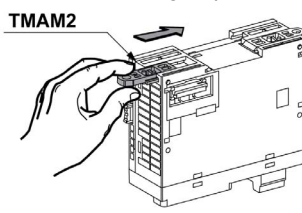
Step	Action
1	<p>Insert the mounting strip TMAM2 into the slot at the top of the module.</p> 

Mounting Hole Layout

The following diagram shows the mounting holes for the TM3XTYS4 expansion modules:

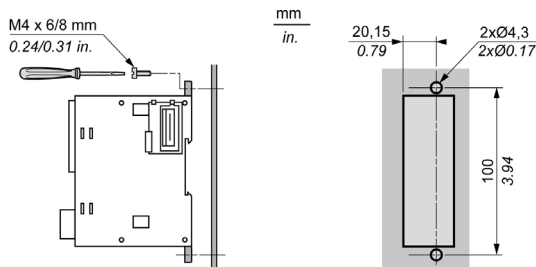

The following diagram shows the mounting holes for the TM3X•HSC202• expansion modules:

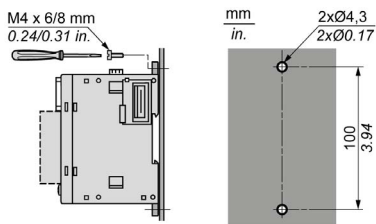

Section 2.3

TM3 Electrical Requirements

Wiring Best Practices

Overview

This section describes the wiring guidelines and associated best practices to be respected when using the TM3 system.

DANGER

HAZARD OF ELECTRIC SHOCK, EXPLOSION OR ARC FLASH

- Disconnect all power from all equipment including connected devices prior to removing any covers or doors, or installing or removing any accessories, hardware, cables, or wires except under the specific conditions specified in the appropriate hardware guide for this equipment.
- Always use a properly rated voltage sensing device to confirm the power is off where and when indicated.
- Replace and secure all covers, accessories, hardware, cables, and wires and confirm that a proper ground connection exists before applying power to the unit.
- Use only the specified voltage when operating this equipment and any associated products.

Failure to follow these instructions will result in death or serious injury.

⚠ WARNING

LOSS OF CONTROL

- The designer of any control scheme must consider the potential failure modes of control paths and, for certain critical control functions, provide a means to achieve a safe state during and after a path failure. Examples of critical control functions are emergency stop and overtravel stop, power outage and restart.
- Separate or redundant control paths must be provided for critical control functions.
- System control paths may include communication links. Consideration must be given to the implications of unanticipated transmission delays or failures of the link.
- Observe all accident prevention regulations and local safety guidelines.¹
- Each implementation of this equipment must be individually and thoroughly tested for proper operation before being placed into service.

Failure to follow these instructions can result in death, serious injury, or equipment damage.

¹ For additional information, refer to NEMA ICS 1.1 (latest edition), "Safety Guidelines for the Application, Installation, and Maintenance of Solid State Control" and to NEMA ICS 7.1 (latest edition), "Safety Standards for Construction and Guide for Selection, Installation and Operation of Adjustable-Speed Drive Systems" or their equivalent governing your particular location.

Functional Ground (FE) on the DIN Rail

The DIN Rail for your TM3 system is common with the functional ground (FE) plane and must be mounted on a conductive backplane.

⚠ WARNING

UNINTENDED EQUIPMENT OPERATION

Connect the DIN rail to the functional ground (FE) of your installation.

Failure to follow these instructions can result in death, serious injury, or equipment damage.

Protective Ground (PE) on the Backplane

The protective ground (PE) is connected to the conductive backplane by a heavyduty wire, usually a braided copper cable with the maximum allowable cable section.

Wiring Guidelines

The following rules must be applied when wiring a TM3 system:

- I/O and communication wiring must be kept separate from the power wiring. Route these 2 types of wiring in separate cable ducting.
- Verify that the operating conditions and environment are within the specification values.
- Use proper wire sizes to meet voltage and current requirements.
- Use minimum 60 °C (140 °F) copper conductors for TM3XTYS4.
- Use minimum 90 °C (194 °F) copper conductors for TM3X•HSC•.
- Use twisted-pair, shielded cables for analog, and/or fast I/O.
- Use twisted-pair, shielded cables for networks, and field bus.

⚠ WARNING
<p>UNINTENDED EQUIPMENT OPERATION</p> <ul style="list-style-type: none"> • Use shielded cables for all fast I/O, analog I/O, and communication signals. • Ground cable shields for all fast I/O, analog I/O, and communication signals at a single point¹. • Route communications and I/O cables separately from power cables. <p>Failure to follow these instructions can result in death, serious injury, or equipment damage.</p>









¹Multipoint grounding is permissible if connections are made to an equipotential ground plane dimensioned to help avoid cable shield damage in the event of power system short-circuit currents.

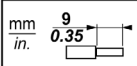

NOTE: Surface temperatures may exceed 60 °C (140 °F).

To conform to IEC 61010 standards, route primary wiring (wires connected to power mains) separately and apart from secondary wiring (extra low voltage wiring coming from intervening power sources). If that is not possible, double insulation is required such as conduit or cable gains.





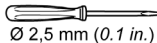



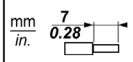

Rules for Removable Screw Terminal Block



The following tables show the cable types and wire sizes for a **3.81 pitch** removable screw terminal block (I/Os and power supply):

								
mm in.	mm ²	AWG	mm ²	AWG	mm ²	AWG	mm ²	AWG
	0.14...1.5	26...16	0.14...1.5	26...16	0.25...0.5	22...16	2 x 0.14...0.5	2 x 26...20
	0.14...1.5	26...16	0.25...1.5	22...16	0.25...0.5	22...20	2 x 0.14...0.75	2 x 26...20
	0.25...0.5	22...16	0.25...1.5	22...16	0.25...0.5	22...20	2 x 0.25...0.34	2 x 24...22
	2 x 0.14...0.5	2 x 26...20	2 x 0.14...0.75	2 x 26...20	2 x 0.25...0.34	2 x 24...22	2 x 0.5	2 x 20

 Ø 2,5 mm (0.1 in.)		N•m	0.28
		lb-in	2.48

The following tables show the cable types and wire sizes for a **5.08 pitch** removable screw terminal block (I/Os and power supply):

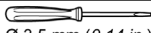
									
mm ²	0.2...2.5	0.2...2.5	0.25...2.5	0.25...2.5	2 x 0.2...1	2 x 0.2...1.5	2 x 0.25...1	2 x 0.5...1.5	2 x 0.5...1.5
AWG	24...14	24...14	23...14	23...14	2 x 24...17	2 x 24...16	2 x 23...17	2 x 20...16	2 x 20...16

		N•m	0.49
Ø 3,5 mm (0.14 in.)		lb-in	4.34

The use of copper conductors is required.

⚠ DANGER





FIRE HAZARD

- Use only the correct wire sizes for the maximum current capacity of the I/O channels and power supplies.
- For relay output (2 A) wiring, use conductors of at least 0.5 mm² (AWG 20) with a temperature rating of at least 80 °C (176 °F).
- For common conductors of relay output wiring (7 A), or relay output wiring greater than 2 A, use conductors of at least 1.0 mm² (AWG 16) with a temperature rating of at least 80 °C (176 °F).



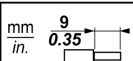



Failure to follow these instructions will result in death or serious injury.

Rules for Removable Spring Terminal Block

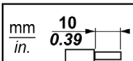
The following tables show the cable types and wire sizes for a **3.81 pitch** removable spring terminal block (I/Os and power supply):

				
mm ²	0.5...1.5	0.5...1.5	0.25...1.0	0.25...0.5
AWG	21...16	21...16	23...18	23...21

The following tables show the cable types and wire sizes for a **5.08 pitch** removable spring terminal block (I/Os and power supply):

					
mm ²	0.2...2.5	0.2...2.5	0.25...2.5	0.25...2.5	2 x 0.5...1
AWG	24...14	24...14	23...14	23...14	2 x 20...17

The use of copper conductors is required.

DANGER

FIRE HAZARD

- Use only the correct wire sizes for the maximum current capacity of the I/O channels and power supplies.
- For relay output (2 A) wiring, use conductors of at least 0.5 mm² (AWG 20) with a temperature rating of at least 80 °C (176 °F).
- For common conductors of relay output wiring (7 A), or relay output wiring greater than 2 A, use conductors of at least 1.0 mm² (AWG 16) with a temperature rating of at least 80 °C (176 °F).

Failure to follow these instructions will result in death or serious injury.

The spring clamp connectors of the terminal block are designed for only one wire or one cable end. Two wires to the same connector must be installed with a double wire cable end to help prevent loosening.

DANGER

LOOSE WIRING CAUSES ELECTRIC SHOCK

Do not insert more than one wire per connector of the spring terminal blocks unless using a double wire cable end (ferrule).

Failure to follow these instructions will result in death or serious injury.

Protecting Outputs from Inductive Load Damage

Depending on the load, a protection circuit may be needed for the outputs on the controllers and certain modules. Inductive loads using DC voltages may create voltage reflections resulting in overshoot that will damage or shorten the life of output devices.

CAUTION

OUTPUT CIRCUIT DAMAGE DUE TO INDUCTIVE LOADS

Use an appropriate external protective circuit or device to reduce the risk of inductive direct current load damage.

Failure to follow these instructions can result in injury or equipment damage.

If your controller or module contains relay outputs, these types of outputs can support up to 240 Vac. Inductive damage to these types of outputs can result in welded contacts and loss of control. Each inductive load must include a protection device such as a peak limiter, RC circuit or flyback diode. Capacitive loads are not supported by these relays.

WARNING

RELAY OUTPUTS WELDED CLOSED

- Always protect relay outputs from inductive alternating current load damage using an appropriate external protective circuit or device.
- Do not connect relay outputs to capacitive loads.

Failure to follow these instructions can result in death, serious injury, or equipment damage.

AC-driven contactor coils are, under certain circumstances, inductive loads that generate pronounced high-frequency interference and electrical transients when the contactor coil is de-energized. This interference may cause the logic controller to detect an I/O bus error.

WARNING

CONSEQUENTIAL LOSS OF CONTROL

Install an RC surge suppressor or similar means, such as an interposing relay, on each TM3 expansion module relay output when connecting to AC-driven contactors or other forms of inductive loads.

Failure to follow these instructions can result in death, serious injury, or equipment damage.

Protective circuit A: this protection circuit can be used for both AC and DC load power circuits.

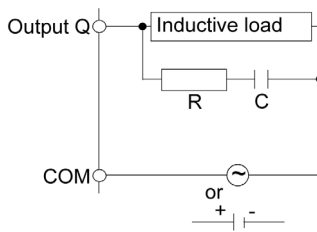

- C represents a value from 0.1 to 1 μF .
- R represents a resistor of approximately the same resistance value as the load.

Protective circuit B: this protection circuit can be used for DC load power circuits.

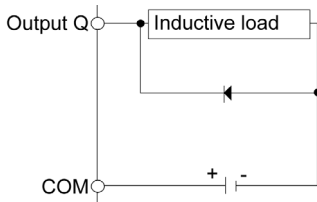

Use a diode with the following ratings:

- Reverse withstand voltage: power voltage of the load circuit x 10.
- Forward current: more than the load current.

Protective circuit C: this protection circuit can be used for both AC and DC load power circuits.

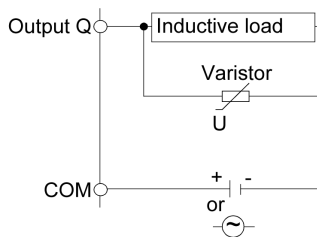

- In applications where the inductive load is switched on and off frequently and/or rapidly, ensure that the continuous energy rating (J) of the varistor exceeds the peak load energy by 20 % or more.

Part II

TM3 Expert Expansion Modules

What Is in This Part?

This part contains the following chapters:

Chapter	Chapter Name	Page
3	TM3XTYS4 TeSys Module	41
4	TM3XFHSC202 / TM3XFHSC202G Module	57
5	TM3XHSC202 / TM3XHSC202G Module	71

Chapter 3

TM3XTYS4 TeSys Module

Overview

This chapter describes the TM3XTYS4 module, its characteristics, and its connection to the different devices.

What Is in This Chapter?

This chapter contains the following topics:

Topic	Page
Environmental Characteristics	42
TM3XTYS4 Presentation	45
TM3XTYS4 Characteristics	51
TM3XTYS4 Wiring Diagram	54

Environmental Characteristics

Enclosure Requirements

TM3 expansion module components are designed as Zone B, Class A industrial equipment according to IEC/CISPR Publication 11. If they are used in environments other than those described in these standards, or in environments that do not meet the specifications in this manual the ability to meet electromagnetic compatibility requirements in the presence of conducted and/or radiated interference may be reduced.

All TM3 expansion module components meet European Community (CE) requirements for open equipment as defined by IEC/EN 61131-2. You must install them in an enclosure designed for the specific environmental conditions and to minimize the possibility of unintended contact with hazardous voltages. Use metal enclosures to improve the electromagnetic immunity of your TM3 expansion module components. Use enclosures with a keyed locking mechanism to minimize unauthorized access.

Environmental Characteristics

All the TM3 expansion module components are electrically isolated between the internal electronic circuit and the input/output channels. This equipment meets CE requirements as indicated in the table below. This equipment is intended for use in a Pollution Degree 2 industrial environment.

⚠ WARNING
UNINTENDED EQUIPMENT OPERATION
Do not exceed any of the rated values specified in the environmental and electrical characteristics tables.
Failure to follow these instructions can result in death, serious injury, or equipment damage.

The following table shows the general environmental characteristics:

Characteristic	Minimum Specification	Tested Range	
Standard compliance	IEC/EN 61131-2	–	
Ambient operating temperature	–	Horizontal installation	–10...55 °C (14...131 °F)
	–	Vertical installation	–10...35 °C (14...95 °F)
Storage and transport temperature	–	–25...70 °C (- 13...158 °F)	
NOTE: The tested ranges may indicate values beyond that of the IEC Standard. However, our internal standards define what is necessary for industrial environments. In all cases, we uphold the minimum specification if indicated.			

Characteristic	Minimum Specification	Tested Range	
Relative humidity	–	Transport and storage	10...95 % (non-condensing)
		Operation	10...95 % (non-condensing)
Degree of pollution	IEC/EN 60664-1	2	
Degree of protection	IEC/EN 61131-2	IP20	
Corrosion immunity	–	Atmosphere free from corrosive gases	
Operating altitude	–	0...2000 m (0...6560 ft)	
Storage altitude	–	0...3000 m (0...9843 ft)	
Vibration resistance	IEC/EN 61131-2	Panel mounting or mounted on a top hat section rail (DIN rail)	10 mm (0.39 in) fixed amplitude from 5...8.7 Hz 29.4 m/s ² (96.45 ft/s ²) (3 g _n) fixed acceleration from 8.7...150 Hz
Mechanical shock resistance	–	147 m/s ² or 482.28 ft/s ² (15 g _n) for a duration of 11 ms	
NOTE: The tested ranges may indicate values beyond that of the IEC Standard. However, our internal standards define what is necessary for industrial environments. In all cases, we uphold the minimum specification if indicated.			

Electromagnetic Susceptibility

The TM3 expansion module components meet electromagnetic susceptibility specifications as indicated in the following table:

Characteristic	Minimum Specification	Tested Range	
Electrostatic discharge	IEC/EN 61000-4-2	8 kV (air discharge) 4 kV (contact discharge)	
Radiated electromagnetic field	IEC/EN 61000-4-3	10 V/m (80...1000 MHz) 3 V/m (1.4...2 GHz) 1 V/m (2...3 GHz)	
Magnetic field	IEC/EN 61000-4-8	30 A/m 50 Hz, 60 Hz	
Fast transients burst	IEC/EN 61000-4-4	–	CM ¹ and DM ²
		24 Vdc I/Os	1 kV
1 Common Mode 2 Differential Mode			
NOTE: The tested ranges may indicate values beyond that of the IEC Standard. However, our internal standards define what is necessary for industrial environments. In all cases, we uphold the minimum specification if indicated.			

Characteristic	Minimum Specification	Tested Range		
Surge immunity	IEC/EN 61000-4-5 IEC/EN 61131-2	–	CM ¹	DM ²
		DC Power lines	1 kV	0.5 kV
		24 Vdc I/Os	1 kV	–
		Shielded cable (between shield and ground)	1 kV	–
Induced electromagnetic field	IEC/EN 61000-4-6	10 Vrms (0.15...80 MHz)		
Conducted emission	IEC 61000-6-4	AC power line:		
		<ul style="list-style-type: none"> ● 0.15...0.5 MHz: 79 dBμV/m QP / 66 dBμV/m AV ● 0.5...300 MHz: 73 dBμV/m QP / 60 dBμV/m AV 		
Radiated emission	IEC 61000-6-4	AC/DC power line:		
		<ul style="list-style-type: none"> ● 10...150 kHz: 120...69 dBμV/m QP ● 150...1500 kHz: 79...63 dBμV/m QP ● 1.5...30 MHz: 63 dBμV/m QP 		
		30...230 MHz: 40 dB μ V/m QP 230...1000 MHz: 47 dB μ V/m QP		
1 Common Mode 2 Differential Mode				
NOTE: The tested ranges may indicate values beyond that of the IEC Standard. However, our internal standards define what is necessary for industrial environments. In all cases, we uphold the minimum specification if indicated.				

TM3XTYS4 Presentation

Overview

TeSys module:

- 4 channels, each with
 - 3 sink inputs
 - 2 source transistor outputs
- Removable 24 Vdc power supply terminal block

Compatibility

For information on the compatibility of this module, refer to EcoStruxure Machine Expert Compatibility and Migration User Guide.

TM3XTYS4 System Architecture

The TM3XTYS4 module connects the controller to the parallel wiring system of TeSys U and/or TeSys D. This parallel wiring module provides the status and command information for each starter. One TM3XTYS4 module can manage up to 4 starters, reverse or forward, whatever they are TeSys D or TeSys U.

TM3XTYS4 module is compatible with:

- TeSys U system
- TeSys D system

TeSys U System Architecture Example

TeSys model U is an integrated modular power management system for motor starters. The system provides motor starter overload protection and control functions.

The complete TeSys model U parallel wiring system consists in:

- a power base
- a contactor
- a thermal overload protection device
- a control unit for controller-starters

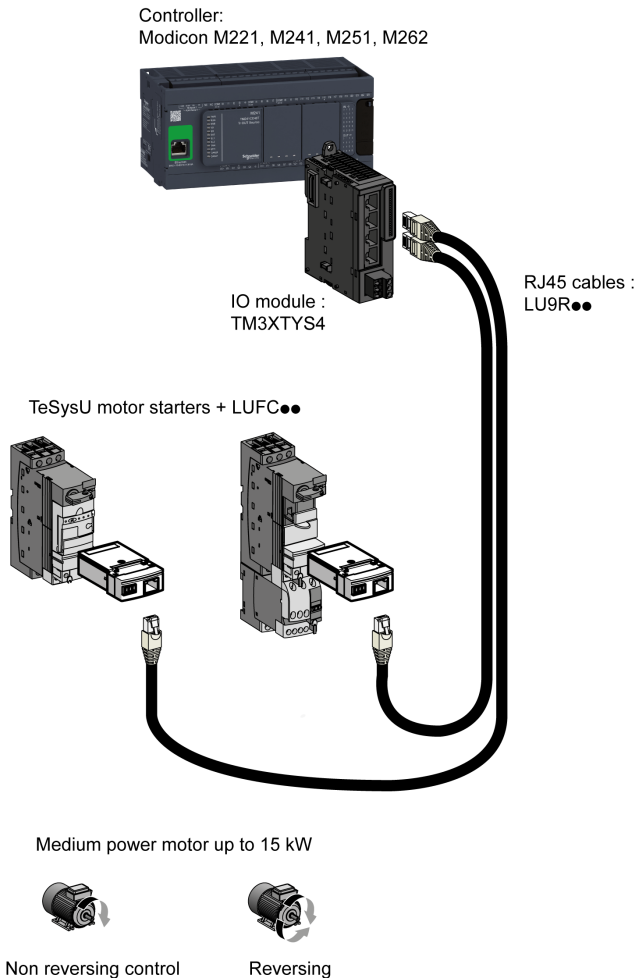

TeSys D System Architecture Example

TeSys model D is a motor control interface system for motor starters. The system provides motor starter overload protection and control functions.

The complete TeSys model D parallel wiring system consists in:

- a power base
- a contactor
- a thermal overload protection device
- a control unit for controller-starters

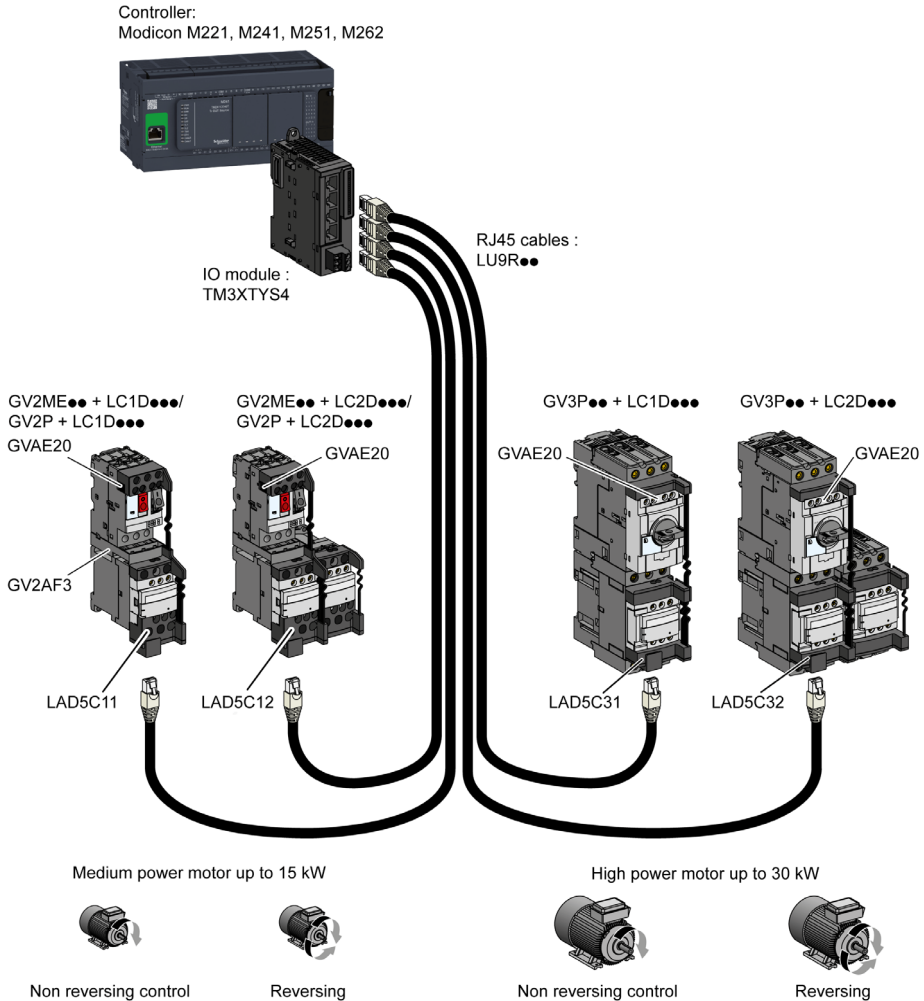

Description

The following figure shows the main elements of the TM3XTYS4 module:

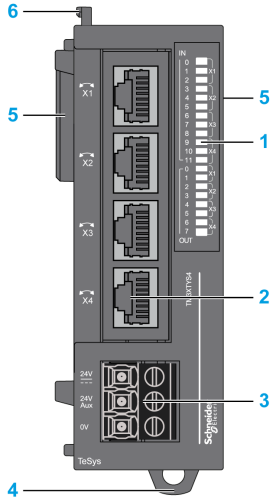

Label	Elements	Refer to
1	LEDs for displaying the state of the I/O channel.	–
2	TeSys RJ45 connectors.	–
3	Power supply screw terminal block.	Power Supply Wiring diagram <i>(see page 56)</i>
4	Clip-on lock for 35 mm (1.38 in.) top hat section rail (DIN-rail).	Top Hat Section Rail (DIN rail) <i>(see page 24)</i>
5	Expansion connector for TM3 I/O bus.	–
6	Locking device for attachment to the previous module.	–

Main Characteristics

Characteristics		Value
Input		Input 1: Ready Input 2: Run Input 3: Trip
Input type		24 Vdc Type 1 (IEC/EN 61131-2)
Logic type		Sink
Output		Output 1: Direction 1 control Output 2: Direction 2 control
Output type		24 Vdc / 0.3 A
Logic type		Source
Cable types and weight		
Cable type and length	Type	Ethernet CAT 5E
	Length	Max. 5 m (16.4 ft)
Weight		115 g (4 oz)

Status LEDs

The following figure shows the status LEDs:

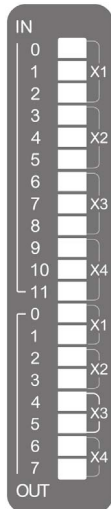

The following table describes the status LEDs:

LED	Color	Status	Type	Description
X1 (0...2)	Green	On	Input	The input channel is activated
		Off		The input channel is deactivated
X2 (3...5)		On		The input channel is activated
		Off		The input channel is deactivated
X3 (6...8)		On		The input channel is activated
		Off		The input channel is deactivated
X4 (9...11)		On		The input channel is activated
		Off		The input channel is deactivated
X1 (0, 1)		On	Output	The output channel is activated
		Off		The output channel is deactivated
X2 (2, 3)		On		The output channel is activated
		Off		The output channel is deactivated
X3 (4, 5)	On	The output channel is activated		
	Off	The output channel is deactivated		
X4 (6, 7)	On	The output channel is activated		
	Off	The output channel is deactivated		

TM3XTYS4 Characteristics

Introduction

This section provides a description of the electrical of the TM3XTYS4 module.
See also Environmental Characteristics (*see page 42*).

⚠ WARNING
UNINTENDED EQUIPMENT OPERATION
Do not exceed any of the rated values specified in the environmental and electrical characteristics tables.
Failure to follow these instructions can result in death, serious injury, or equipment damage.

Dimensions

The following diagrams show the dimensions for the TM3XTYS4 module:

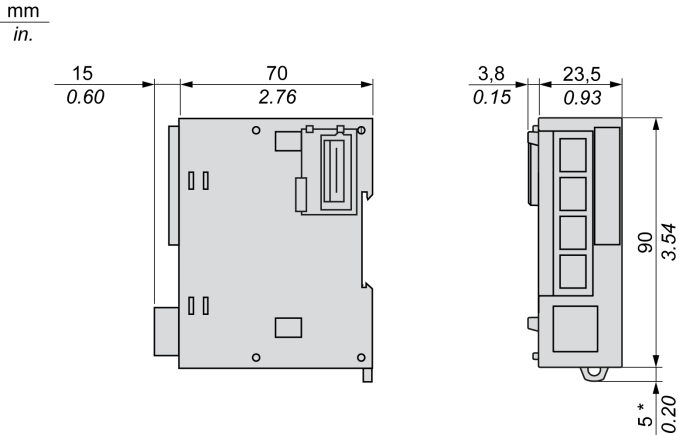

Input/Output Characteristics

The following table describes the characteristics of one channel RJ45 connector:

Characteristic	Value
Inputs	3 inputs <ul style="list-style-type: none"> ● Input 1: Ready ● Input 2: Run ● Input 3: Trip
Number of channels groups	1 common line for 3 inputs *
Input type	Type 1 (IEC/EN 61131-2)
Logic type	Sink
Rated input voltage	24 Vdc
Input voltage range	19.2...28.8 Vdc
Rated input current	5 mA
Turn on time	Typically 5 ms
Turn off time	Typically 5 ms
Outputs	2 outputs <ul style="list-style-type: none"> ● Output 1: Direction 1 control ● Output 2: Direction 2 control
Output type	Transistor
Logic type	Source
Rated input voltage	24 Vdc
Output voltage range	19.2...28.8 Vdc
Rated output current	300 mA per channel
Voltage drop	Typically 0.15 Vdc (0.4 Vdc max.)
Leakage current when switched off	0.1 mA max.
Inductive load	L/R = 10 ms
Turn on time	Typically 400 μs (450 μs max.)
Turn off time	Typically 400 μs (450 μs max.)
Protection against short circuit	Yes
Clamping voltage	Typically 40 Vdc
* The common line (pins 3) of the 4 RJ45 connectors are internally connected together. The 12 inputs of the module share the same common.	

Characteristic		Value
Module		
Isolation	Between input and internal logic	500 Vac
	Between output and internal logic	500 Vac
Connection type		RJ45 connector
Connector insertion/removal durability		Over 100 times
Current draw on 5 Vdc internal bus		37 mA (all inputs and outputs on)
		17 mA (all inputs and outputs off)
Current draw on 24 Vdc internal bus		17 mA (all inputs and outputs on)
		0 mA (all inputs and outputs off)
* The common line (pins 3) of the 4 RJ45 connectors are internally connected together. The 12 inputs of the module share the same common.		

TM3XTYS4 Wiring Diagram

Wiring Rules

See Wiring Best Practices (*see page 31*).

I/O Channel RJ45 Connector

The TM3XTYS4 module is equipped with 4 channels RJ45 connector:

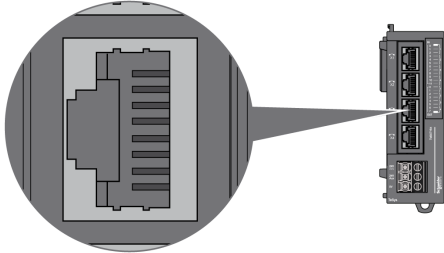

Pin Assignment

The following graphic and table show the channel RJ45 connector pin assignment:

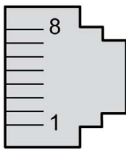

Pin N°	Designation	Signal	Description
1	Output 1	Direction 1 control	Drives the direct (forward) command of the motor.
2	Output 2	Direction 2 control	Drives the reverse (backward) command of the motor.
3	0 V	–	–
4	Input 1	Ready	Active if the selector of TeSys is in the ON position.
5	Input 2	Run	Input active if the power contacts of TeSys are closed.
6	N.C.	–	Reserved. Do not connect.
7	Input 3	Trip	Input active if the selector of TeSys is in the TRIP position (only for TeSys U).
8	24 Vdc input common	Common for sensors	Power supply for inputs 1, 2 and 3 (pins 4, 5 and 7).

 **WARNING**

UNINTENDED EQUIPMENT OPERATION

Do not connect wires to unused terminals and/or terminals indicated as “No Connection (N.C.)”.

Failure to follow these instructions can result in death, serious injury, or equipment damage.

 **CAUTION**

INCOMPATIBLE EQUIPMENT

Use the RJ45 connector only for the link with devices which are compatible with the TeSys RJ45 connection system.

Failure to follow these instructions can result in injury or equipment damage.

DC Power Supply Wiring Diagram

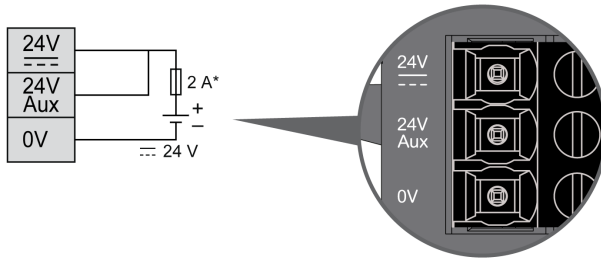

- * type T fuse
 24 Vdc Aux is dedicated to inputs power supply.
 24 Vdc is dedicated to outputs power supply.

⚠ WARNING

POTENTIAL OF OVERHEATING AND FIRE

- Do not connect the equipment directly to line voltage.
- Use only isolating PELV power supplies to supply power to the equipment¹.

Failure to follow these instructions can result in death, serious injury, or equipment damage.

¹ For compliance to UL (Underwriters Laboratories) requirements, the power supply must also conform to the various criteria of NEC Class 2, and be inherently current limited to a maximum power output availability of less than 100 VA (approximately 4 A at nominal voltage), or not inherently limited but with an additional protection device such as a circuit breaker or fuse meeting the requirements of clause 9.4 Limited-energy circuit of UL 61010-1. In all cases, the current limit should never exceed that of the electric characteristics and wiring diagrams for the equipment described in the present documentation. In all cases, the power supply must be grounded, and you must separate Class 2 circuits from other circuits. If the indicated rating of the electrical characteristics or wiring diagrams are greater than the specified current limit, multiple Class 2 power supplies may be used.

For more details, refer to the Wiring Best Practices. (*see page 33*)

Chapter 4

TM3XFHSC202 / TM3XFHSC202G Module

Overview

This chapter describes the TM3XFHSC202 / TM3XFHSC202G modules, their characteristics, and their connection to the different devices.

What Is in This Chapter?

This chapter contains the following topics:

Topic	Page
Environmental Characteristics	58
TM3XFHSC202 / TM3XFHSC202G Presentation	61
TM3XFHSC202 / TM3XFHSC202G Characteristics	63
TM3XFHSC202 / TM3XFHSC202G Wiring Diagram	67

Environmental Characteristics

Enclosure Requirements

TM3 expansion module components are designed as Zone B, Class A industrial equipment according to IEC/CISPR Publication 11. If they are used in environments other than those described in these standards, or in environments that do not meet the specifications in this manual the ability to meet electromagnetic compatibility requirements in the presence of conducted and/or radiated interference may be reduced.

All TM3 expansion module components meet European Community (CE) requirements for open equipment as defined by IEC/EN 61131-2. You must install them in an enclosure designed for the specific environmental conditions and to minimize the possibility of unintended contact with hazardous voltages. Use metal enclosures to improve the electromagnetic immunity of your TM3 expansion module components. Use enclosures with a keyed locking mechanism to minimize unauthorized access.

Environmental Characteristics

All the TM3 expansion module components are electrically isolated between the internal electronic circuit and the input/output channels. This equipment meets CE requirements as indicated in the table below. This equipment is intended for use in a Pollution Degree 2 industrial environment.

⚠ WARNING
UNINTENDED EQUIPMENT OPERATION
Do not exceed any of the rated values specified in the environmental and electrical characteristics tables.
Failure to follow these instructions can result in death, serious injury, or equipment damage.

The following table shows the general environmental characteristics:

Characteristic	Minimum Specification	Tested Range	
Standard compliance	IEC/EN 61131-2 UL/CSA 61010-1, -2-201	–	
Ambient operating temperature	–	Horizontal installation	–20...60 °C (-4...140 °F)
	–	Vertical installation	–20...50 °C (-4...122 °F)
Storage and transport temperature	–	–40...85 °C (- 40...185 °F)	
NOTE: The tested ranges may indicate values beyond that of the IEC Standard. However, our internal standards define what is necessary for industrial environments. In all cases, we uphold the minimum specification if indicated.			

Characteristic	Minimum Specification	Tested Range	
Relative humidity	–	Transport and storage	10...95 % (non-condensing)
	–	Operation	10...95 % (non-condensing)
Degree of pollution	IEC/EN 60664-1	2	
Degree of protection	IEC/EN 61131-2	IP20	
Corrosion immunity	–	Atmosphere free from corrosive gases	
Operating altitude	–	0...2000 m (0...6560 ft)	
Storage altitude	–	0...3000 m (0...9843 ft)	
Vibration resistance	IEC/EN 61131-2	Panel mounting or mounted on a top hat section rail (DIN rail)	3.5 mm (0.13 in) fixed amplitude from 2...8.4 Hz 9.8 m/s ² or 32.15 ft/s ² (1 g _n) fixed acceleration from 8.4...200 Hz
Mechanical shock resistance	–	147 m/s ² or 482.28 ft/s ² (15 g _n) for a duration of 11 ms	
NOTE: The tested ranges may indicate values beyond that of the IEC Standard. However, our internal standards define what is necessary for industrial environments. In all cases, we uphold the minimum specification if indicated.			

Electromagnetic Susceptibility

The TM3 expansion module components meet electromagnetic susceptibility specifications as indicated in the following table:

Characteristic	Minimum Specification	Tested Range	
Electrostatic discharge	IEC/EN 61000-4-2	8 kV (air discharge) 4 kV (contact discharge)	
Radiated electromagnetic field	IEC/EN 61000-4-3	10 V/m (80...1000 MHz) 3 V/m (1.4...2 GHz) 1 V/m (2...3 GHz)	
Fast transients burst	IEC/EN 61000-4-4	24 Vdc I/Os	2 kV (clamp)
		Digital I/Os	1 kV (clamp)
Induced electromagnetic field	IEC/EN 61000-4-6	10 Vrms (0.15...80 MHz)	
Conducted emission	IEC 61000-6-4	DC power line: <ul style="list-style-type: none"> ● 10...150 kHz: 120...69 dBμV/m QP ● 150...1500 kHz: 79...63 dBμV/m QP ● 1.5...30 MHz: 63 dBμV/m QP 	
Radiated emission	IEC 61000-6-4	30...230 MHz: 40 dB μ V/m QP 230...1000 MHz: 47 dB μ V/m QP	
1 Common Mode 2 Differential Mode			
NOTE: The tested ranges may indicate values beyond that of the IEC Standard. However, our internal standards define what is necessary for industrial environments. In all cases, we uphold the minimum specification if indicated.			

TM3XFHSC202 / TM3XFHSC202G Presentation

Overview

The TM3XFHSC202 (screw) and the TM3XFHSC202G (spring) are counting modules with event handling that are used for counting functions and position detection.

Compatibility

For information on the compatibility of these modules, refer to EcoStruxure Machine Expert Compatibility and Migration User Guide.

Architecture

The TM3 bus supports up to seven modules in the local configuration and up to seven modules in a remote configuration.

TM3XFHSC202 / TM3XFHSC202G modules support events if connected directly to an M262 controller or to another TM3XFHSC202 / TM3XFHSC202G. That is to say, you can configure the events on the module if the module is the first TM3XFHSC202 / TM3XFHSC202G modules connected to the M262 controller, or is the second TM3XFHSC202 / TM3XFHSC202G module connected to the M262 controller given the first module is also a TM3XFHSC202 / TM3XFHSC202G module.

Description

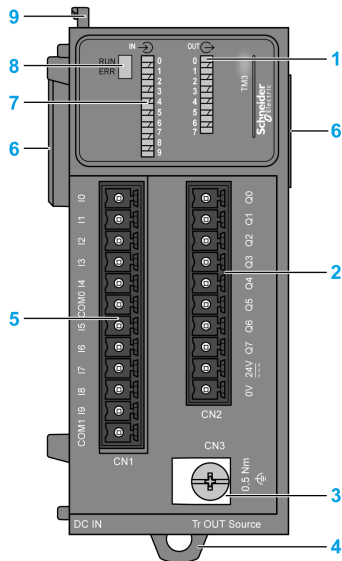

The following figure shows the main elements of the TM3XFHSC202 / TM3XFHSC202G modules:

Label	Elements	Refer to
1	Outputs status LEDs	-
2	Removable outputs terminal block	-
3	Functional ground screw	-
4	Clip-on lock for 35 mm (1.38 in.) top hat section rail (DIN rail)	-
5	Removable inputs terminal block	Grounding (<i>see page 69</i>)
6	I/O expansion connector	-
7	Input status LEDs	-
8	Status LEDs	-
9	Locking device	-

Module Status LEDs

The following table shows the status LEDs:

RUN (Green)	ERR (Red)	Description
Off	Off	Module is not configured
Off	On	Module detected a system error
Fast flashing	Off	Module firmware is being updated
Operational		
On	Off	Module is configured and operational
	1 flash per second	Controller is RUNNING - 24Vdc outputs supply is off
	2 flashes per second	Controller is RUNNING - Short circuit on an output
	3 flashes per second	Controller is RUNNING - Event overflow
Regular flashing	1 flash per second	Controller is STOPPED - 24Vdc outputs supply is off
	2 flashes per second	Controller is STOPPED - Short circuit on an output
	3 flashes per second	Controller is STOPPED - Event overflow

Input/Output Status LEDs

The following table shows the status LEDs:

Type	LED	Color	Status	Description
Input	0-9	Green	On	The input channel is activated.
			Off	The input channel is deactivated.
Output	0-7	Green	On	The output channel is activated.
			Off	The output channel is deactivated.

TM3XFHSC202 / TM3XFHSC202G Characteristics

Introduction

This section provides a description of the characteristics of the TM3XFHSC202 / TM3XFHSC202G modules. See also Environmental Characteristics (*see page 42*).

⚠ WARNING

UNINTENDED EQUIPMENT OPERATION

Do not exceed any of the rated values specified in the environmental and electrical characteristics tables.

Failure to follow these instructions can result in death, serious injury, or equipment damage.

Dimensions

The following diagram shows the dimensions of the TM3XFHSC202 / TM3XFHSC202G modules:

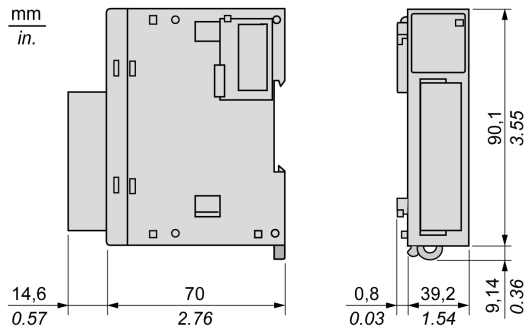

General Characteristics

Characteristics	Value
Rated power supply voltage	24 Vdc
Voltage limit	20.4...28.8 Vdc
Current draw on 5 Vdc internal bus	Typically 65 mA at 25°C (77°F), maximum 110 mA
Current draw on 24 Vdc internal bus	Typically 30 mA at 25°C (77°F), maximum 50 mA
Isolation between input and internal logic	550 Vac for 1 min
Isolation between output and internal logic	550 Vac for 1 min

Characteristics	Value
Connection type	TM3XFHSC202 / TM3XHSC202: Removable screw terminal block TM3XFHSC202G / TM3XHSC202G: Removable spring terminal block
Connector insertion/removal durability	Over 100 times
Weight	120 g without terminal block 150 g with terminal block

Input Characteristics

Characteristics	Value	
Number	10	
Number of channel groups	2 channel groups: 1 common line for I0 ...I4 1 common line for I5 ...I9	
Input type	Type 1 (IEC 61131-2)	
Logic type	Sink	
Rated input voltage	24 Vdc	
Input voltage limit	Maximum 30 Vdc	
Rated input current	7.5 mA	
Input impedance	2.81 k Ω	
Input limit values	Voltage at state 1	> 15 Vdc (15...28.8 Vdc)
	Voltage at state 0	< 5 Vdc (0...5 Vdc)
	Current at state 1	> 3 mA
	Current at state 0	< 1.5 mA
Turn on time	< 1 μ s + filter delay	
Turn off time	< 1 μ s + filter delay	
Maximum input frequency	200 kHz	
Isolation	Between input and internal logic	550 Vac for 1 minute
	Between input groups	None
	Between input channels	None
	Between inputs and outputs	550 Vac for 1 minute
Cable type	Shielded cable, including the COM signal Length: Maximum 10 m	

Output Characteristics

Characteristics	Value
Number	8
Number of channel groups	2 channel groups: Q0...Q3 Q4...Q7
Output type	Transistor
Logic type	Source (push-pull)
Rated output voltage	24 Vdc
Rated output current	300 mA
Total rated output current per group	Maximum 1.2 A
Maximum power of filament lamp	Maximum 0.9 W
Leakage current	≤ 0.15 mA
Turn on time	Maximum 1 μs
Turn off time	Maximum 1 μs
Protection against short circuit or overload	Yes, typically 1 A per output Defect managed by group: <ul style="list-style-type: none"> ● Q0...Q3 ● Q4...Q7
Automatic rearming after short circuit or overload	Yes, 10 s Enabled/Disabled by EcoStruxure Machine Expert
Clamping voltage	Typically 45 Vdc
Isolation	Between outputs and internal logic: 550 Vac for 1 minute
	Between output groups: none
	Between output channels: none
	Between outputs and inputs: 550 Vac for 1 minute
Cable length	< 30 m

Power Characteristics

Characteristics	Value
Type	PELV
Voltage nominal	24 Vdc
Voltage limits	20.4...28.8 Vdc with a maximum ripple of 10% of nominal voltage
Input current	Maximum 2.5 A
Inrush current	Not limited (except by overload peak current)
Voltage drop immunity	No
Reverse polarity protection	Yes
Overvoltage protection	No (external fuse required)
Power presence detection	Yes, threshold 15 V
Isolation	550 Vac for 1 minute with internal logic
Cable length	< 3 m

TM3XFHSC202 / TM3XFHSC202G Wiring Diagram

Introduction

These expansion modules have a built-in removable screw or spring terminal block for the connection of outputs and power supply.

Wiring Rules

See Wiring Best Practices (*see page 31*).

Wiring Diagram

The following diagram shows the wiring of the inputs:

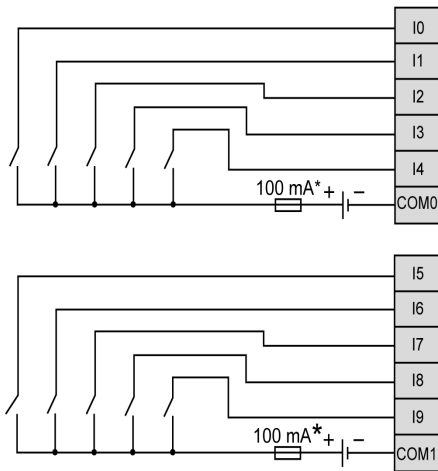

* Type T fuse

⚠ WARNING

UNINTENDED EQUIPMENT OPERATION

Ensure that the physical wiring respects the connections indicated in the wiring diagram. In particular, that the **24V** terminal is connected, only 24 Vdc is connected to the **24V** terminal, and only 0 Vdc is connected to the **0V** terminal.

Failure to follow these instructions can result in death, serious injury, or equipment damage.

The following diagram shows the wiring outputs:

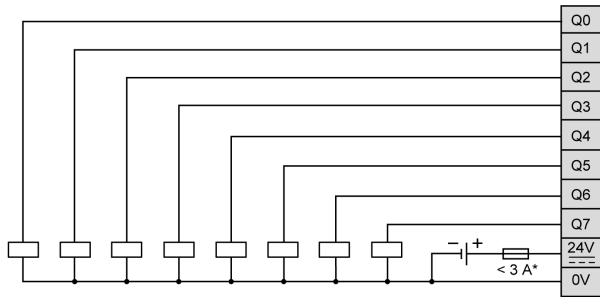

* Connect an appropriate type T fuse for the load, not to exceed 3 A.

Encoder Wiring

The following diagram shows the encoder wiring:

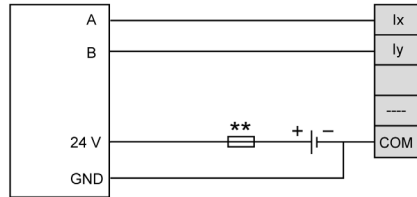

** Refer to the encoder documentation for fuse sizing

NOTE:

You must connect the output GND of the encoder to the COM terminal corresponding to the group of inputs which A and B are connected to:

- I0...I4: COM0
- I5...I9: COM1

Grounding

The following diagram shows how to wire the screw to the functional ground:

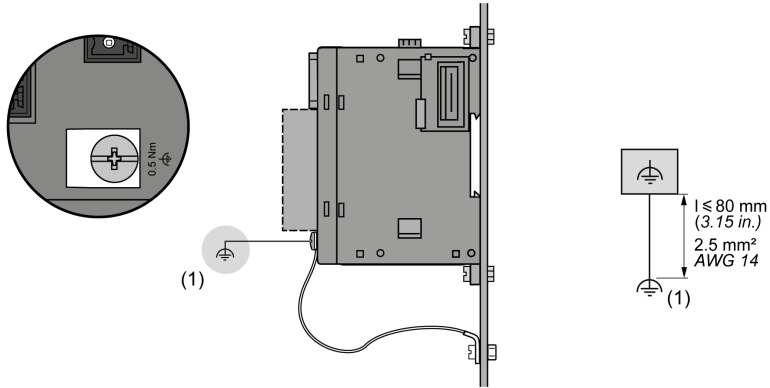

 Phillips Ph2		N•m	0,5
		lb-in	4.4

(1) Functional ground (FE)

Applying torque above the limit may damage the terminal screw or threads.

NOTICE

INOPERABLE EQUIPMENT

Do not tighten screw terminals beyond the specified maximum torque (Nm / lb-in.).

Failure to follow these instructions can result in equipment damage.

The following diagram shows how to connect the input and output cable shielding to the functional earth:

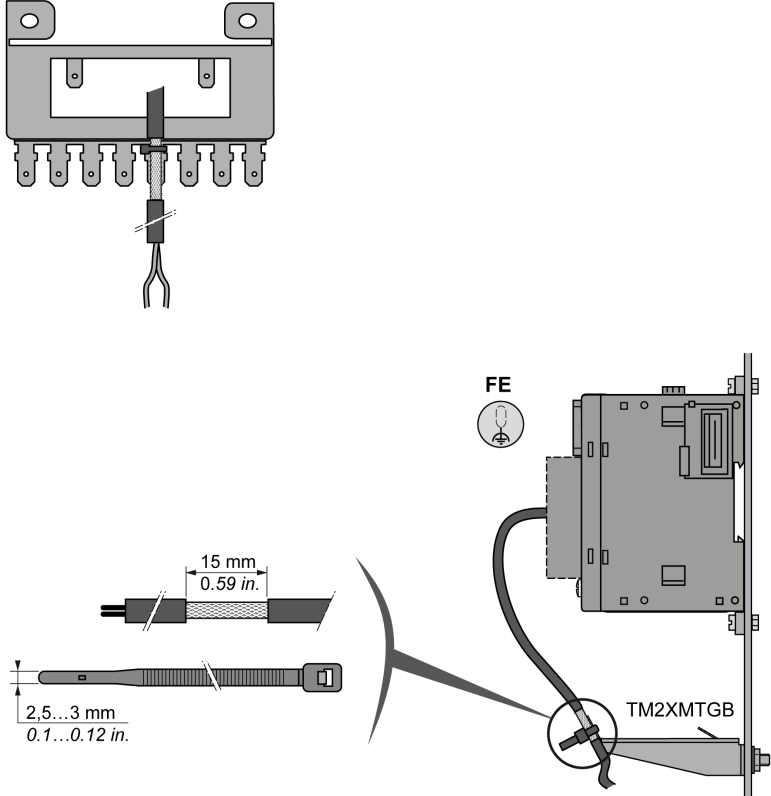

NOTE: The power supply wiring must be kept as short as possible.

Chapter 5

TM3XHSC202 / TM3XHSC202G Module

Overview

This chapter describes the TM3XHSC202 / TM3XHSC202G modules, their characteristics, and their connection to the different devices.

What Is in This Chapter?

This chapter contains the following topics:

Topic	Page
Environmental Characteristics	72
TM3XHSC202 / TM3XHSC202G Presentation	75
TM3XHSC202 / TM3XHSC202G Characteristics	77
TM3XHSC202 / TM3XHSC202G Wiring Diagram	81

Environmental Characteristics

Enclosure Requirements

TM3 expansion module components are designed as Zone B, Class A industrial equipment according to IEC/CISPR Publication 11. If they are used in environments other than those described in these standards, or in environments that do not meet the specifications in this manual the ability to meet electromagnetic compatibility requirements in the presence of conducted and/or radiated interference may be reduced.

All TM3 expansion module components meet European Community (CE) requirements for open equipment as defined by IEC/EN 61131-2. You must install them in an enclosure designed for the specific environmental conditions and to minimize the possibility of unintended contact with hazardous voltages. Use metal enclosures to improve the electromagnetic immunity of your TM3 expansion module components. Use enclosures with a keyed locking mechanism to minimize unauthorized access.

Environmental Characteristics

All the TM3 expansion module components are electrically isolated between the internal electronic circuit and the input/output channels. This equipment meets CE requirements as indicated in the table below. This equipment is intended for use in a Pollution Degree 2 industrial environment.

⚠ WARNING
UNINTENDED EQUIPMENT OPERATION
Do not exceed any of the rated values specified in the environmental and electrical characteristics tables.
Failure to follow these instructions can result in death, serious injury, or equipment damage.

The following table shows the general environmental characteristics:

Characteristic	Minimum Specification	Tested Range	
Standard compliance	IEC/EN 61131-2 UL/CSA 61010-1, -2-201	–	
Ambient operating temperature	–	Horizontal installation	–20...60 °C (-4...140 °F)
	–	Vertical installation	–20...50 °C (-4...122 °F)
Storage and transport temperature	–	–40...85 °C (- 40...185 °F)	
NOTE: The tested ranges may indicate values beyond that of the IEC Standard. However, our internal standards define what is necessary for industrial environments. In all cases, we uphold the minimum specification if indicated.			

Characteristic	Minimum Specification	Tested Range	
Relative humidity	–	Transport and storage	10...95 % (non-condensing)
	–	Operation	10...95 % (non-condensing)
Degree of pollution	IEC/EN 60664-1	2	
Degree of protection	IEC/EN 61131-2	IP20	
Corrosion immunity	–	Atmosphere free from corrosive gases	
Operating altitude	–	0...2000 m (0...6560 ft)	
Storage altitude	–	0...3000 m (0...9843 ft)	
Vibration resistance	IEC/EN 61131-2	Panel mounting or mounted on a top hat section rail (DIN rail)	3.5 mm (0.13 in) fixed amplitude from 2...8.4 Hz 9.8 m/s ² or 32.15 ft/s ² (1 g _n) fixed acceleration from 8.4...200 Hz
Mechanical shock resistance	–	147 m/s ² or 482.28 ft/s ² (15 g _n) for a duration of 11 ms	
<p>NOTE: The tested ranges may indicate values beyond that of the IEC Standard. However, our internal standards define what is necessary for industrial environments. In all cases, we uphold the minimum specification if indicated.</p>			

Electromagnetic Susceptibility

The TM3 expansion module components meet electromagnetic susceptibility specifications as indicated in the following table:

Characteristic	Minimum Specification	Tested Range	
Electrostatic discharge	IEC/EN 61000-4-2	8 kV (air discharge) 4 kV (contact discharge)	
Radiated electromagnetic field	IEC/EN 61000-4-3	10 V/m (80...1000 MHz) 3 V/m (1.4...2 GHz) 1 V/m (2...3 GHz)	
Fast transients burst	IEC/EN 61000-4-4	24 Vdc I/Os	2 kV (clamp)
		Digital I/Os	1 kV (clamp)
Induced electromagnetic field	IEC/EN 61000-4-6	10 Vrms (0.15...80 MHz)	
Conducted emission	IEC 61000-6-4	DC power line: <ul style="list-style-type: none"> ● 10...150 kHz: 120...69 dBμV/m QP ● 150...1500 kHz: 79...63 dBμV/m QP ● 1.5...30 MHz: 63 dBμV/m QP 	
Radiated emission	IEC 61000-6-4	30...230 MHz: 40 dB μ V/m QP 230...1000 MHz: 47 dB μ V/m QP	
1 Common Mode 2 Differential Mode			
NOTE: The tested ranges may indicate values beyond that of the IEC Standard. However, our internal standards define what is necessary for industrial environments. In all cases, we uphold the minimum specification if indicated.			

TM3XHSC202 / TM3XHSC202G Presentation

Overview

The TM3XHSC202 (screw) and the TM3XHSC202G (spring) are counting modules that are used for counting functions and position detection.

Compatibility

For information on the compatibility of these modules, refer to EcoStruxure Machine Expert Compatibility and Migration User Guide.

Architecture

The TM3 bus supports up to seven modules in the local configuration and up to seven modules in a remote configuration.

Description

The following figure shows the main elements of the TM3XHSC202 / TM3XHSC202G modules:

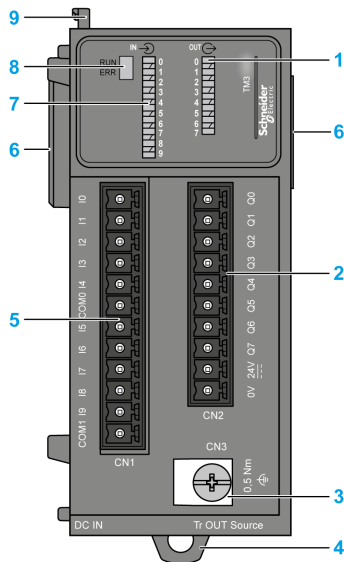

Label	Elements
1	Outputs status LEDs
2	Removable outputs terminal block
3	Functional ground screw
4	Clip-on lock for 35 mm (1.38 in.) top hat section rail (DIN rail)
5	Removable inputs terminal block
6	I/O expansion connector
7	Inputs status LEDs
8	Status LEDs
9	Locking device

Module Status LEDs

The following table shows the status LEDs:

RUN (Green)	ERR (Red)	Description
Off	Off	Module is not configured
Off	On	Module detected a system error
Fast flashing	Off	Module firmware is being updated
Operational		
On	Off	Module is configured and operational
	1 flash per second	Controller is RUNNING - 24Vdc outputs supply is off
	2 flashes per second	Controller is RUNNING - Short circuit on an output
Regular flashing	1 flash per second	Controller is STOPPED - 24Vdc outputs supply is off
	2 flashes per second	Controller is STOPPED - Short circuit on an output

Input/Output Status LEDs

The following table shows the status LEDs:

Type	LED	Color	Status	Description
Input	0-9	Green	On	The input channel is activated.
			Off	The input channel is deactivated.
Output	0-7	Green	On	The output channel is activated.
			Off	The output channel is deactivated.

TM3XHSC202 / TM3XHSC202G Characteristics

Introduction

This section provides a description of the characteristics of the TM3XHSC202 / TM3XHSC202G modules. See also Environmental Characteristics (*see page 42*).

⚠ WARNING

UNINTENDED EQUIPMENT OPERATION

Do not exceed any of the rated values specified in the environmental and electrical characteristics tables.

Failure to follow these instructions can result in death, serious injury, or equipment damage.

Dimensions

The following diagram shows the dimensions of the TM3XHSC202 / TM3XHSC202G modules:

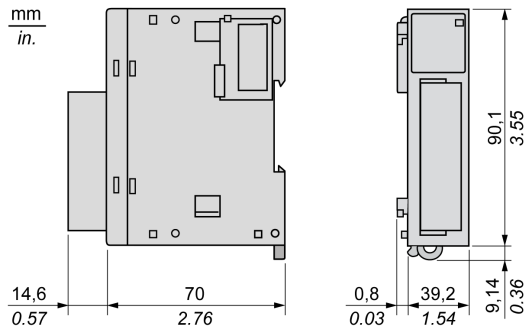

General Characteristics

Characteristics	Value
Rated power supply voltage	24 Vdc
Voltage limit	20.4...28.8 Vdc
Current draw on 5 Vdc internal bus	Typically 65 mA at 25°C (77°F), maximum 110 mA
Current draw on 24 Vdc internal bus	Typically 30 mA at 25°C (77°F), maximum 50 mA
Isolation between input and internal logic	550 Vac for 1 min
Isolation between output and internal logic	550 Vac for 1 min

Characteristics	Value
Connection type	TM3XFHSC202 / TM3XHSC202: Removable screw terminal block TM3XFHSC202G / TM3XHSC202G: Removable spring terminal block
Connector insertion/removal durability	Over 100 times
Weight	120 g without terminal block 150 g with terminal block

Input Characteristics

Characteristics	Value	
Number	10	
Number of channel groups	2 channel groups: 1 common line for I0 ...I4 1 common line for I5 ...I9	
Input type	Type 1 (IEC 61131-2)	
Logic type	Sink	
Rated input voltage	24 Vdc	
Input voltage limit	Maximum 30 Vdc	
Rated input current	7.5 mA	
Input impedance	2.81 k Ω	
Input limit values	Voltage at state 1	> 15 Vdc (15...28.8 Vdc)
	Voltage at state 0	< 5 Vdc (0...5 Vdc)
	Current at state 1	> 3 mA
	Current at state 0	< 1.5 mA
Turn on time	< 1 μ s + filter delay	
Turn off time	< 1 μ s + filter delay	
Maximum input frequency	200 kHz	
Isolation	Between input and internal logic	550 Vac for 1 minute
	Between input groups	None
	Between input channels	None
	Between inputs and outputs	550 Vac for 1 minute
Cable type	Shielded cable, including the COM signal Length: Maximum 10 m	

Output Characteristics

Characteristics	Value
Number	8
Number of channel groups	2 channel groups: Q0...Q3 Q4...Q7
Output type	Transistor
Logic type	Source (push-pull)
Rated output voltage	24 Vdc
Rated output current	300 mA
Total rated output current per group	Maximum 1.2 A
Maximum power of filament lamp	Maximum 0.9 W
Leakage current	≤ 0.15 mA
Turn on time	Maximum 1 μs
Turn off time	Maximum 1 μs
Protection against short circuit or overload	Yes, typically 1 A per output Defect managed by group: <ul style="list-style-type: none"> ● Q0...Q3 ● Q4...Q7
Automatic rearming after short circuit or overload	Yes, 10 s Enabled/Disabled by EcoStruxure Machine Expert
Clamping voltage	Typically 45 Vdc
Isolation	Between outputs and internal logic: 550 Vac for 1 minute
	Between output groups: none
	Between output channels: none
	Between outputs and inputs: 550 Vac for 1 minute
Cable length	< 30 m

Power Characteristics

Characteristics	Value
Type	PELV
Voltage nominal	24 Vdc
Voltage limits	20.4...28.8 Vdc with a maximum ripple of 10% of nominal voltage
Input current	Maximum 2.5 A
Inrush current	Not limited (except by overload peak current)
Voltage drop immunity	No
Reverse polarity protection	Yes
Overvoltage protection	No (external fuse required)
Power presence detection	Yes, threshold 15 V
Isolation	550 Vac for 1 minute with internal logic
Cable length	< 3 m

TM3XHSC202 / TM3XHSC202G Wiring Diagram

Introduction

The TM3XHSC202 / TM3XHSC202G are equipped with two removable connection screw terminal blocks for the connection of inputs and outputs.

Wiring Rules

See Wiring Best Practices (*see page 31*).

Wiring Diagram

The following diagram shows the wiring of the inputs:

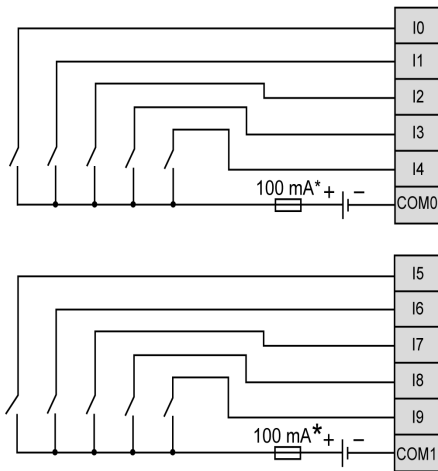

* Type T fuse

⚠ WARNING

UNINTENDED EQUIPMENT OPERATION

Ensure that the physical wiring respects the connections indicated in the wiring diagram. In particular, that the **24V** terminal is connected, only 24 Vdc is connected to the **24V** terminal, and only 0 Vdc is connected to the **0V** terminal.

Failure to follow these instructions can result in death, serious injury, or equipment damage.

The following diagram shows the wiring of the outputs:

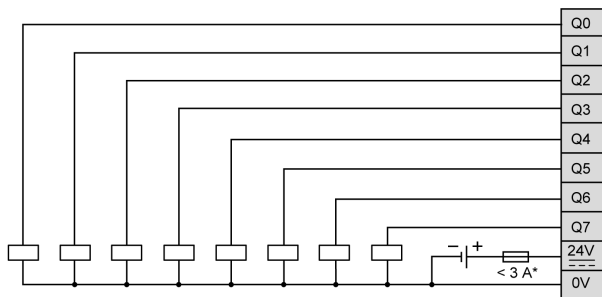

* Connect an appropriate type T fuse for the load, not to exceed 3 A.

Encoder Wiring

The following diagram shows the encoder wiring:

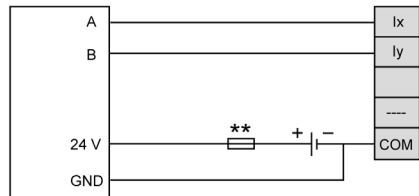

** Refer to the encoder documentation for fuse sizing

NOTE:

You must connect the output GND of the encoder to the COM terminal corresponding to the group of inputs which A and B are connected to:

- I0...I4: COM0
- I5...I9: COM1

Grounding

The following diagram shows how to wire the screw to the functional ground:

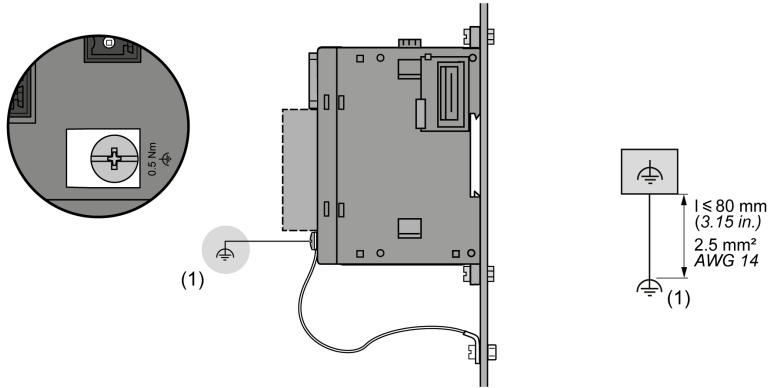

 Phillips Ph2		N•m	0,5
		lb-in	4.4

(1) Functional ground (FE)

Applying torque above the limit may damage the terminal screw or threads.

NOTICE

INOPERABLE EQUIPMENT

Do not tighten screw terminals beyond the specified maximum torque (Nm / lb-in.).

Failure to follow these instructions can result in equipment damage.

The following diagram shows how to connect the input and output cable shielding to the functional earth:

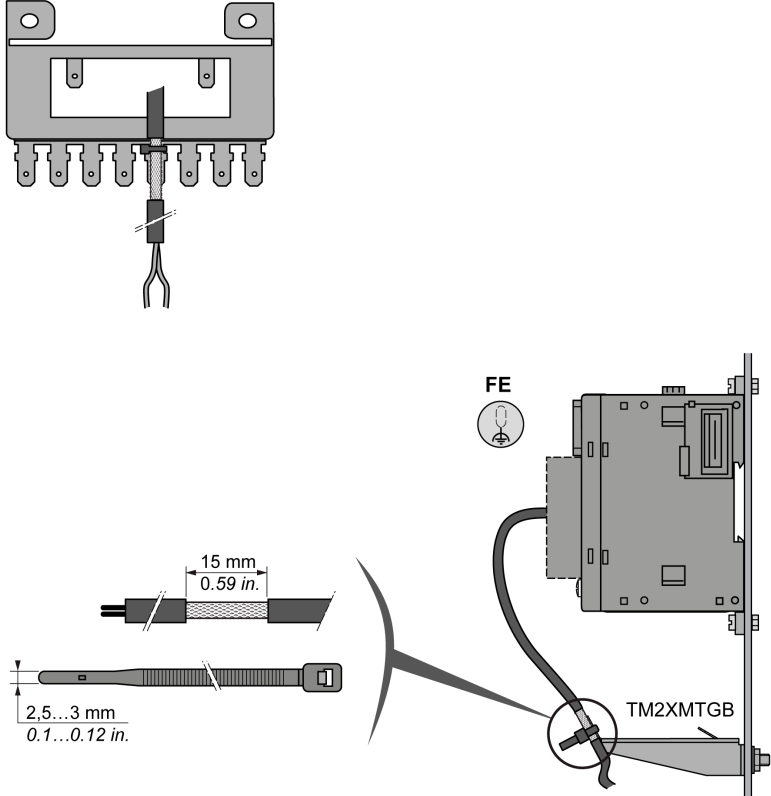

NOTE: The power supply wiring must be kept as short as possible.

Glossary



A

application

A program including configuration data, symbols, and documentation.

C

controller

Automates industrial processes (also known as programmable logic controller or programmable controller).

E

EIA rack

(*electronic industries alliance rack*) A standardized (EIA 310-D, IEC 60297, and DIN 41494 SC48D) system for mounting various electronic modules in a stack or rack that is 19 inches (482.6 mm) wide.

EN

EN identifies one of many European standards maintained by CEN (*European Committee for Standardization*), CENELEC (*European Committee for Electrotechnical Standardization*), or ETSI (*European Telecommunications Standards Institute*).

expansion bus

An electronic communication bus between expansion I/O modules and a controller or bus coupler.

expansion connector

A connector to attach expansion I/O modules.

H

HE10

Rectangular connector for electrical signals with frequencies below 3 MHz, complying with IEC 60807-2.

I

I/O

(*input/output*)

IEC

(*international electrotechnical commission*) A non-profit and non-governmental international standards organization that prepares and publishes international standards for electrical, electronic, and related technologies.

IP 20

(*ingress protection*) The protection classification according to IEC 60529 offered by an enclosure, shown by the letter IP and 2 digits. The first digit indicates 2 factors: helping protect persons and for equipment. The second digit indicates helping protect against water. IP 20 devices help protect against electric contact of objects larger than 12.5 mm, but not against water.

N

NEMA

(*national electrical manufacturers association*) The standard for the performance of various classes of electrical enclosures. The NEMA standards cover corrosion resistance, ability to help protect from rain, submersion, and so on. For IEC member countries, the IEC 60529 standard classifies the ingress protection rating for enclosures.

P

program

The component of an application that consists of compiled source code capable of being installed in the memory of a logic controller.

R

RJ45

A standard type of 8-pin connector for network cables defined for Ethernet.

T

terminal block

(*terminal block*) The component that mounts in an electronic module and provides electrical connections between the controller and the field devices.



A

assembling to a controller, *27*

C

certifications and standards, *18*

controllers

 disassembling a module, *29*

D

dimensions

 TM3XFHSC2, *63*

 TM3XHSC202, *77*

 TM3XTYS4, *51*

E

Electromagnetic Susceptibility, *43, 60, 74*

environmental characteristics, *42, 58, 72*

I

Inductive Load, Output Protection

 Output Protection, Inductive Load, *36*

intended use, *6*

M

minimum clearances, *23*

mounting position, *23*

Q

qualification of personnel, *6*

S

specifications

 modules, *15*

T

Tesys modules

 specifications, *15*

TM3XFHSC2

 characteristics, *63*

 presentation, *61*

TM3XHSC2

 presentation, *75*

TM3XHSC202

 characteristics, *77*

TM3XTYS4

 characteristics, *51*

 presentation, *45*

 wiring, *54*

W

wiring rules, *31*

