



Technical Guide - 2017

Stago

Fibre-Optic Duct System

schneider-electric.com/stago

Life Is On

Schneider
Electric



Green Premium™

Endorsing eco-friendly products in the industry



Green Premium™ Product

Green Premium is the only label that allows you to effectively develop and promote an environmental policy whilst preserving your business efficiency. This ecolabel guarantees compliance with up-to-date environmental regulations, but it does more than this.

Over 75% of Schneider Electric manufactured products have been awarded the Green Premium ecolabel



Discover what we mean by green

Check your products!

Schneider Electric's Green Premium ecolabel is committed to offering transparency, by disclosing extensive and reliable information related to the environmental impact of its products:

RoHS

Schneider Electric products are subject to RoHS requirements at a worldwide level, even for the many products that are not required to comply with the terms of the regulation. Compliance certificates are available for products that fulfil the criteria of this European initiative, which aims to eliminate hazardous substances.

REACH

Schneider Electric applies the strict REACH regulation on its products at a worldwide level, and discloses extensive information concerning the presence of SVHC (Substances of Very High Concern) in all of these products.

PEP: Product Environmental Profile

Schneider Electric publishes complete set of environmental data, including carbon footprint and energy consumption data for each of the lifecycle phases on all of its products, in compliance with the ISO 14025 PEP ecopassport program. PEP is especially useful for monitoring, controlling, saving energy, and/or reducing carbon emissions.

EoLI: End of Life Instructions

Available at the click of a button, these instructions provide:

- Recyclability rates for Schneider Electric products.
- Guidance to mitigate personnel hazards during the dismantling of products and before recycling operations.
- Parts identification for recycling or for selective treatment, to mitigate environmental hazards/ incompatibility with standard recycling processes.

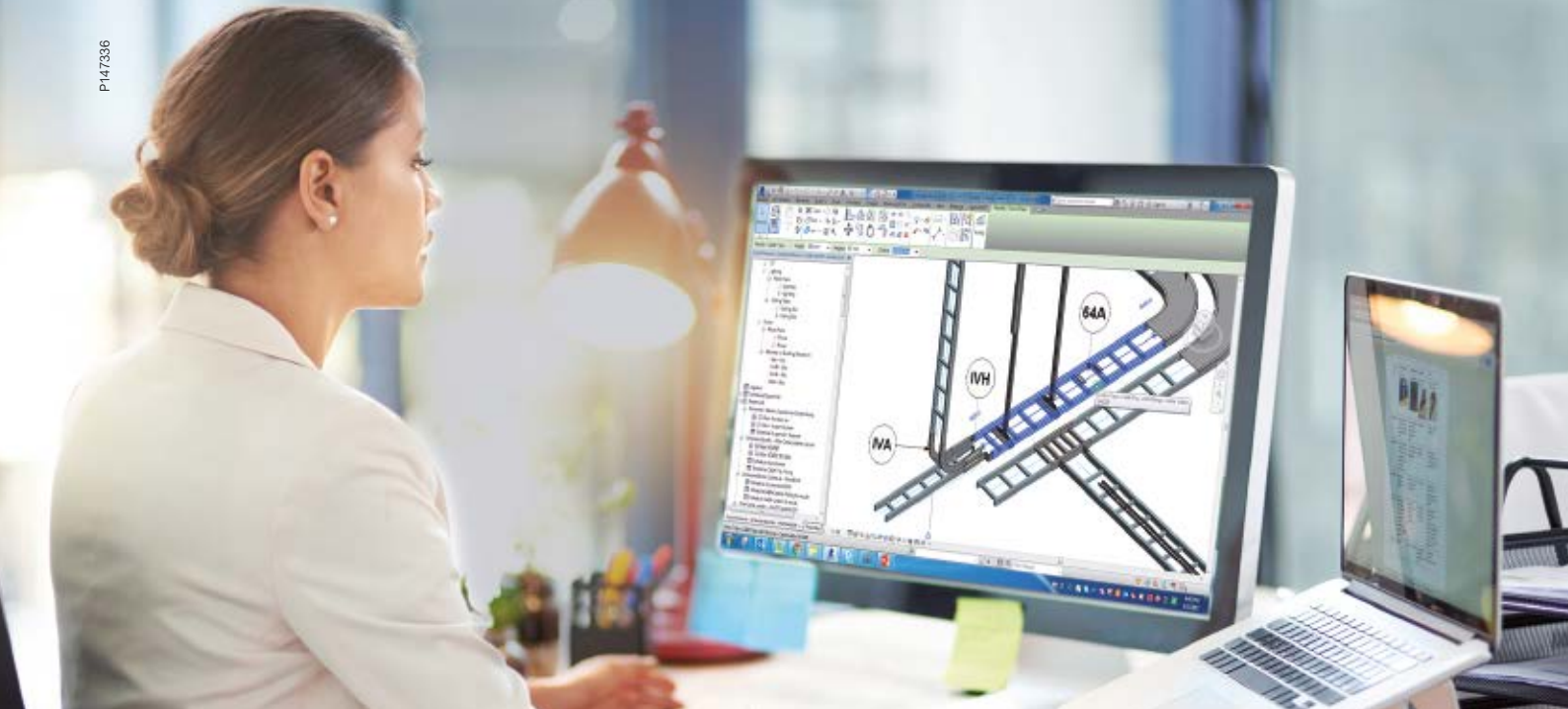

Cable Support is BIM Ready



Discover and download our Cable Support BIM models today by clicking or scanning the QR code.



If you're an architect, engineer, or contractor working on a BIM (Building Information Modeling) project design, you can now take advantage of Schneider Electric's comprehensive and user-friendly online BIM models library.

Here you can download from a wide range of BIM models and benefit from features we provide such as a support system, video explanations, customized selection components, extended-schedule generation, as well as size-error detection.

So rest assured, we have the perfect Cable Support BIM model for you to integrate into your project, so you can benefit from a design process that is intuitive, collaborative, and easy-to-configure.

Content

Introduction	6
--------------	---

Technical characteristics	12
---------------------------	----

Mounting Guide	24
----------------	----

Customization handbook	30
------------------------	----

Safety recommendations	34
------------------------	----

Introduction



P150063

Stago Fibre-Optic Duct

A dynamic and durable carrier

The “White space” is the heart of the Data Centre. The hub where millions of tiny fibre optic cables connect at the speed of light. Constantly On and evolving in pace with increasing demands, impersonating the term “living being”.

The Stago Fibre-Optic Ducts are the carriers of all heavy traffic in the Data Centre. Stable and strong, they are ready to perform. And once mounted, they will last and always be ready to evolve for new, unpredictable demands.

The evolving system

Quick and easy to install, made for continuous development – always avoiding downtime. Swiftly adaptable to changing needs thanks to modular, tool-less accessories. A true “plug & play” concept.

With efficiency in mind

A sturdy and robust steel system that allows long support distances without sagging, thus saving mounting time. And the consoles with one side open for cable management saves cabling and maintenance time. By suiting all ducts, ladders and busbars, the support system is both rational and economical.



The Stago Fibre-Optic Duct is all metal and carries a higher load compared to non-metal systems. This means longer spans, minimised support, no sagging – and an overall more efficient and easily expandable installation.

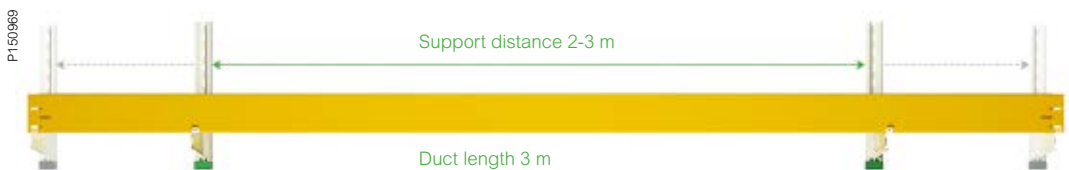

Ideal rail lengths

The 3-m duct is optimised for fast but non-heavy mounting. Add smart modular covers and support distances up to 3 m and you have a high-speed installation.

Suitable dimensions

Stago FO ducts are available in heights of 60 or 110 mm, and widths of 100, 200, or 300 mm. All with the same smooth and soft shape.

More than yellow

Standard colour of the ducting is yellow, RAL 1023. Other colours can be delivered on special order.

P150970



P150965



Introduction

1. Fibre-Optic Duct
2. Duct cover
3. Separation wall
4. Branching piece
5. Internal riser
6. External riser
7. 90° Bend
8. T-piece
9. X-piece
10. End piece
11. Drop-off UDF
12. Patch panel bracket set
13. RJ45 bracket
14. Hinge coupler
15. External coupler
16. Bolt set (M6)
17. Cover clamp
18. Internal Coupler Unilock

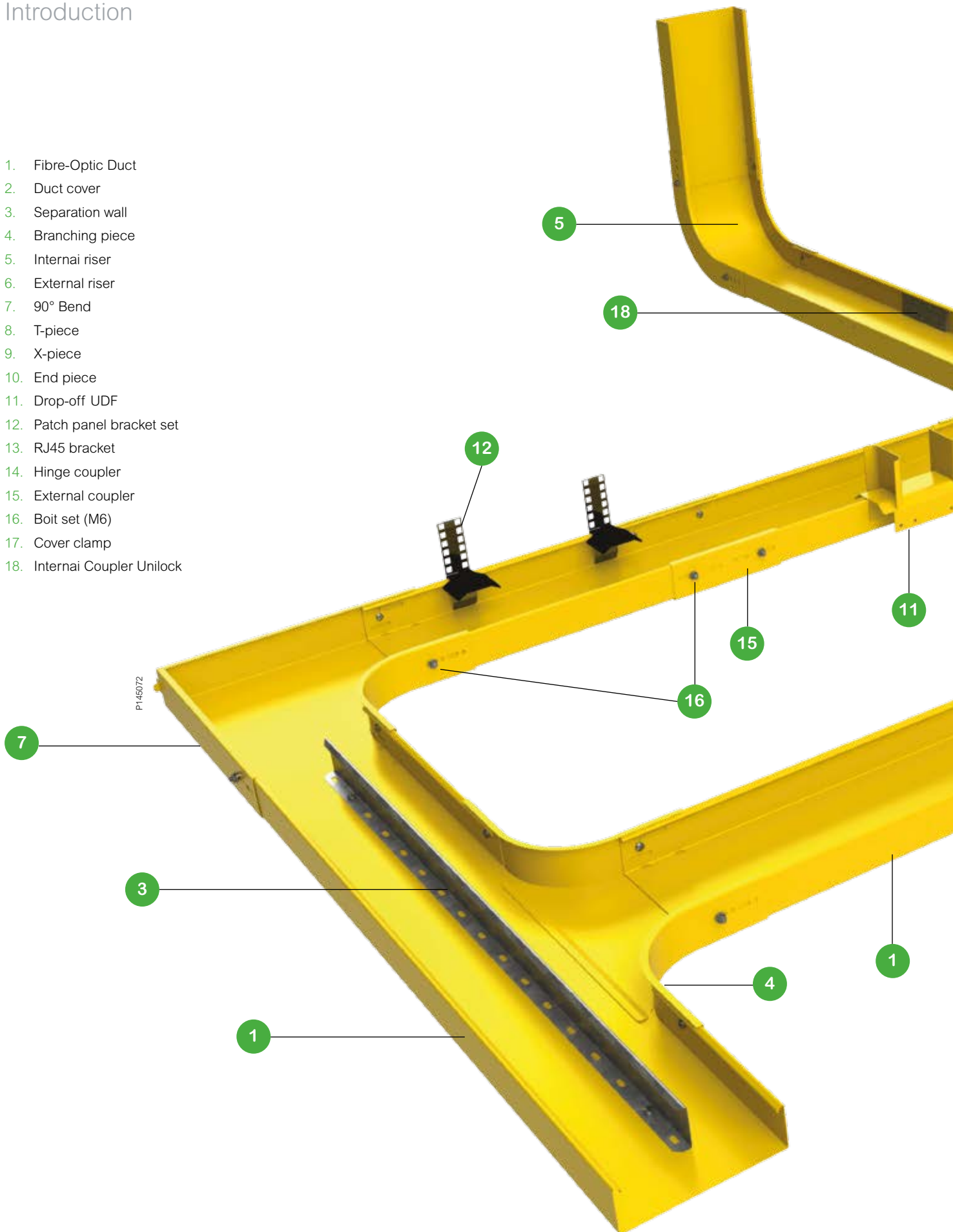

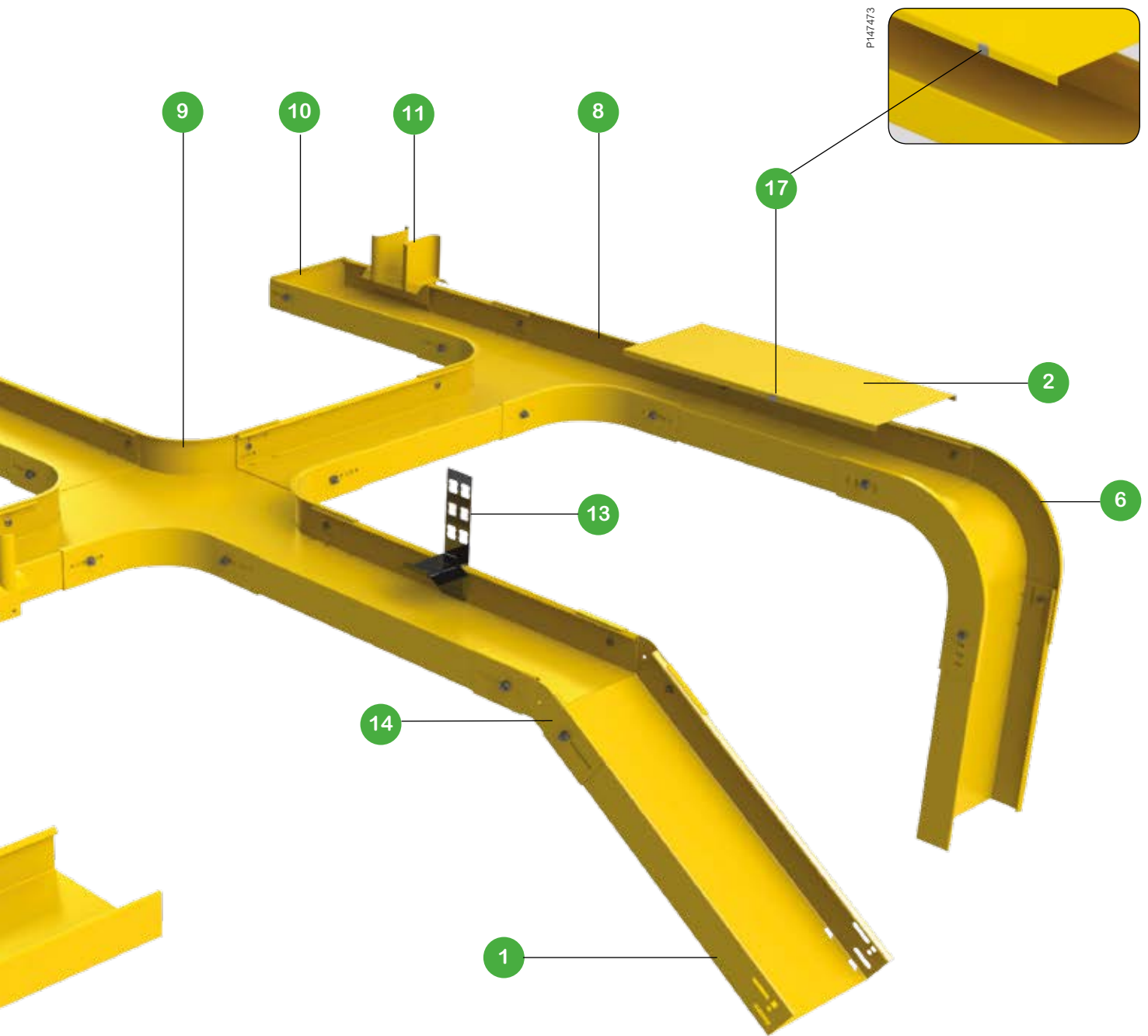

High-performance management

Every component of the Stago FO Duct range is designed and developed with the same passionate care about both the fibre and the management. No matter how complex the configuration is, our ambition is that you do not have to worry about what is already installed, because it just works. Instead you can enjoy the easiness of further development of the plan to create new opportunities.

Introduction

1. Claw
2. Ceiling bracket 2F
3. Bracket 50i
4. C bracket
5. Omega L
6. Omega C
7. Suspension beam
8. Threaded rod

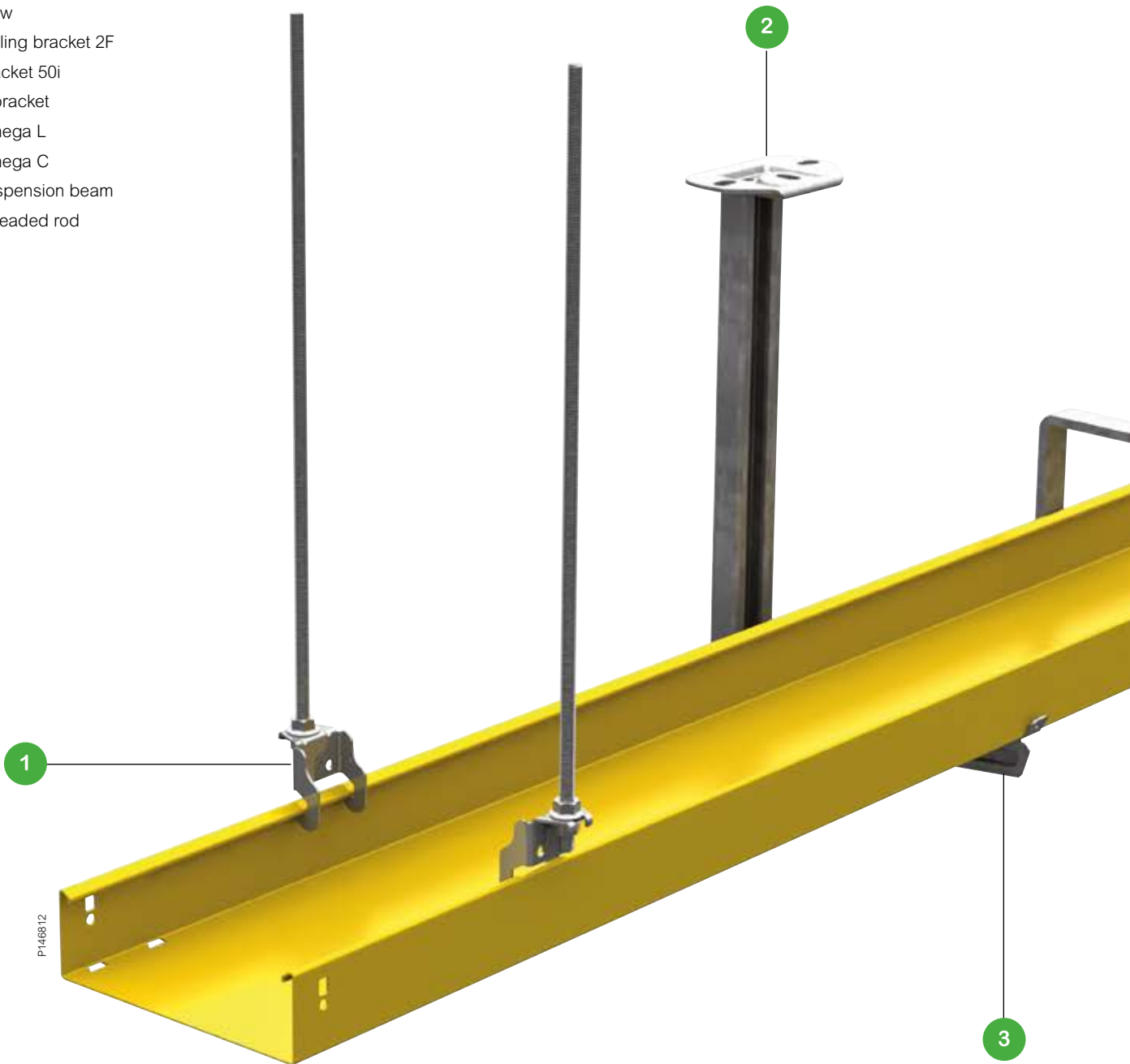

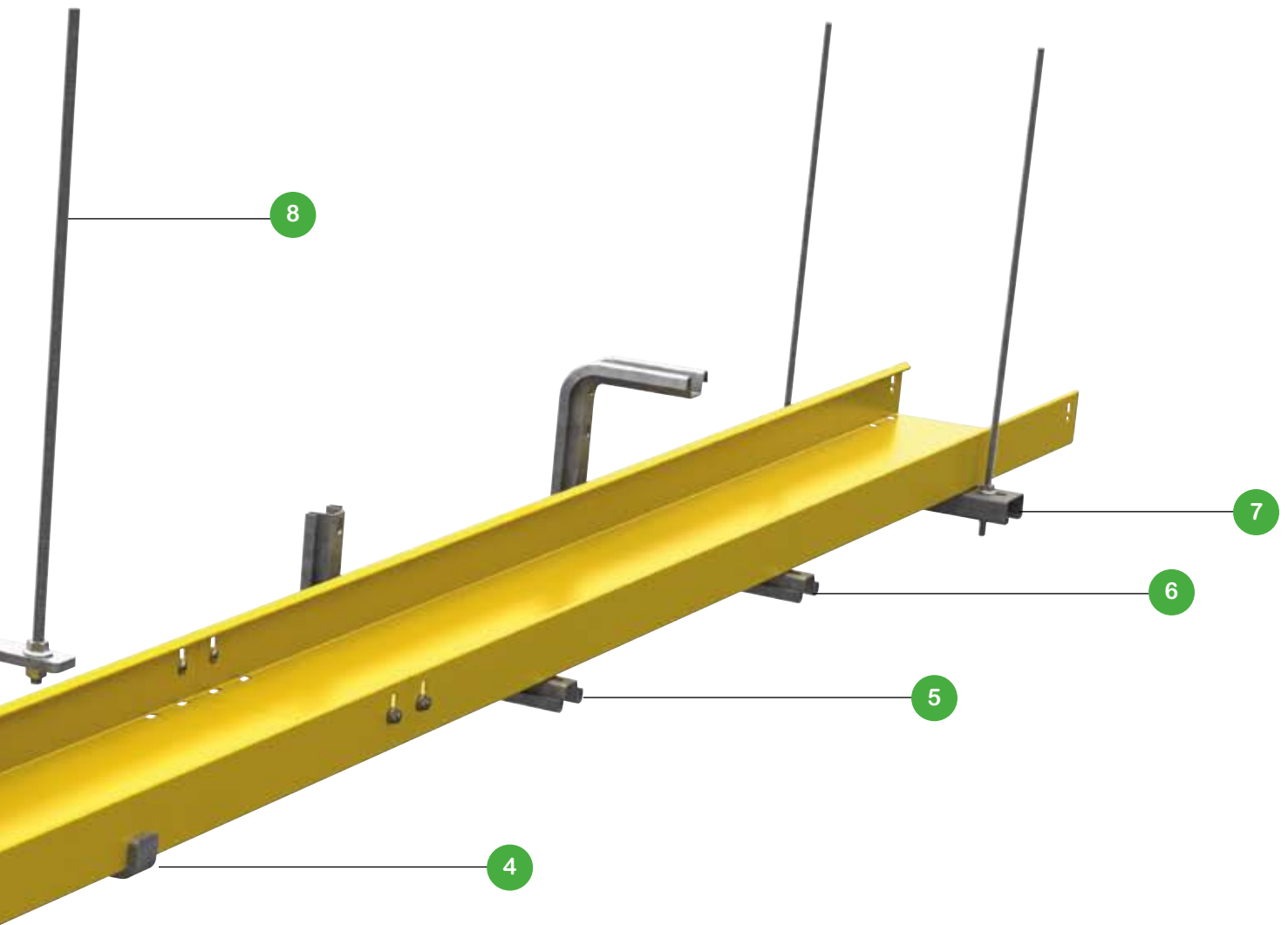

Optimized support system

Few supports needed to build complex configurations. The single pendant support with robust consoles leaves one side easy open, allowing fast and easy cable management. Suits all types of cable support and busbars.



Technical characteristics

P147388



Technical characteristics

Standards and Directives	14
Stago - Fibre-optic Duct	15
Bending radius	15
Cable filling capacity	15
Safe working load	16
Support working Loads and Span recommendations	17
Dimensions	18

P147342



P147343



P147344



P147345



IEC 61537 specifies requirements and tests for cable tray, cable ladder and cable ducting systems intended for the support and accommodation of cables and possibly other electrical equipment in electrical and/or communication systems installation.

The standard EN 61537 establishes that for Cable Ducts with electrical continuity characteristics (metal), this continuity should be guaranteed by means of an equipotential connection and one or several connections to earth in accordance with the use of the Cable Duct system.

To guarantee a safe installation, Schneider Electric recommends a proper earthing of all elements that make up the system (section and accessories), using the accessories designed specifically for this purpose.

Management system - Quality and Environment

Schneider Electric has a third-party certified management system for quality and environment system for quality and environment in accordance with ISO 9001:2015 and ISO 14001:2015.

CE-marking of products

The CE-marking of products is placed on the product or on the packaging according to Low Voltage Directive 2014/35/EU, applicable to Schneider Electric Cable Support System.

P147346



EMC directive 2004/108/EC

The Cable Support System is neutral according to the EMC directive 2004/108/EC.

Low voltage directive 2014/35

Schneider Electric fulfills the demands according to the harmonized standard IEC 61537 Edition 2:2006.

Stago Fibre-Optic Duct

Bending Radius
Cable Filling Capacity

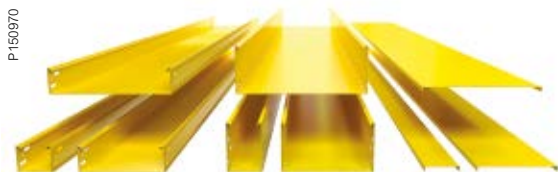

Stago fibre-optic duct offer is now available in:

- System height: 60 mm and 110 mm
- Widths: 100 mm, 200 mm and 300 mm
- Length: 3 m

The standard cable ducts are painted in yellow (RAL1023).

Bending radius

In fibre-optic installations fiber stress through bending must be limited or eliminated completely. In respect of this limitation a specific design of round form pieces provide a minimum of 50mm bend radius for fibre-optic cables.

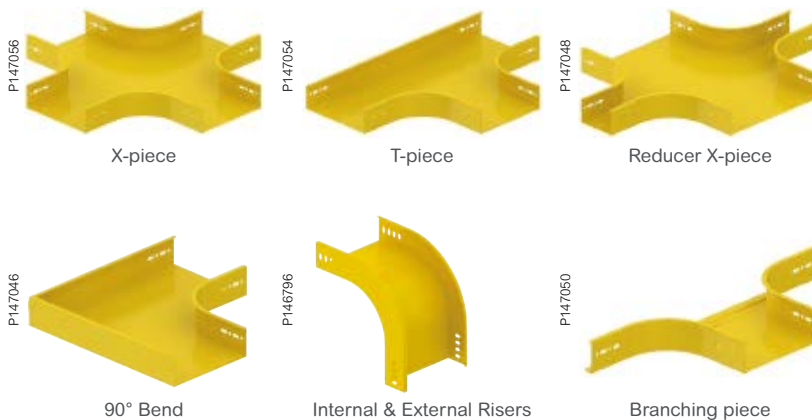
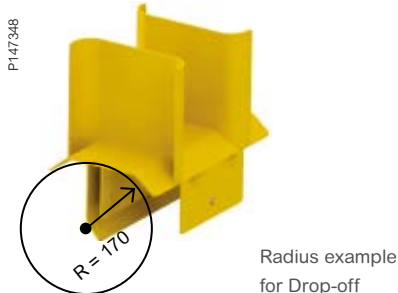
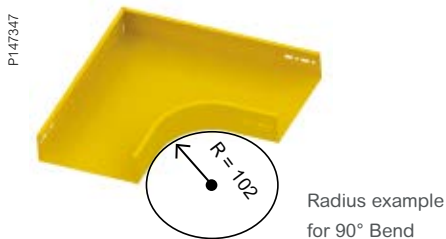

Modular accessories

For enhanced protection of fibre-optic cables, modular accessories such as drop-off pieces were designed in respect of a minimum of 50 mm bend radius.

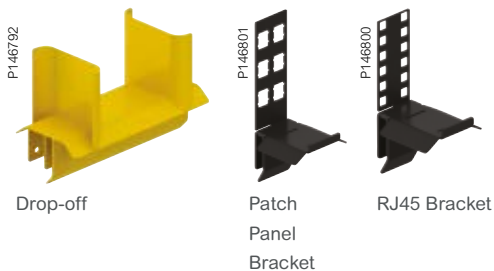

Cable Filling Capacity

The figures in the table below are calculated considering a 50% cable loading factor.

Cable Duct Cat. No.	Dimensions H x W (mm)	Cable Filling Capacity (Load factor of 50%)			
		Optical Fibre			
		Ø1.2 mm	Ø1.6 mm	Ø2 mm	Ø3 mm
CSU7600104FS123	60 x 100	1653	1413	905	402
CSU7600204FS123	60 x 200	4218	2856	1828	812
CSU7600304FS123	60 x 300	6782	4298	2751	1223
CSU7100104FS123	110 x 100	3820	2632	1684	749
CSU7100204FS123	110 x 200	8594	5318	3403	1513
CSU7100304FS123	110 x 300	13369	8004	5122	2277

Note: The figures in the table represent the number of cables.

Stago Fibre-Optic Duct

Safe Working Load

The Safe Working Load values correspond to an evenly distributed load that can be applied with guaranteed safety in the normal conditions of use of the ducts, according to the results obtained from the tests made in accordance with the criteria of the standard for cable trays.

The tests were carried out in accordance with IEC 61537 standard for the type 1.

P147349

Cable Duct 60x100

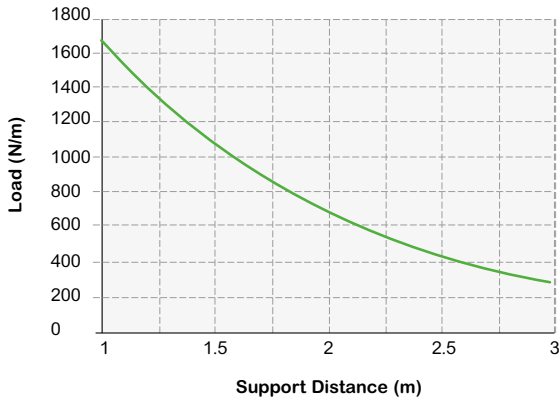

Cable Duct 110x100

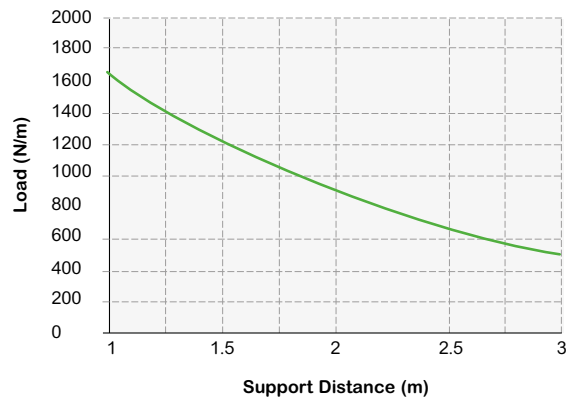

Cable Duct 60x200

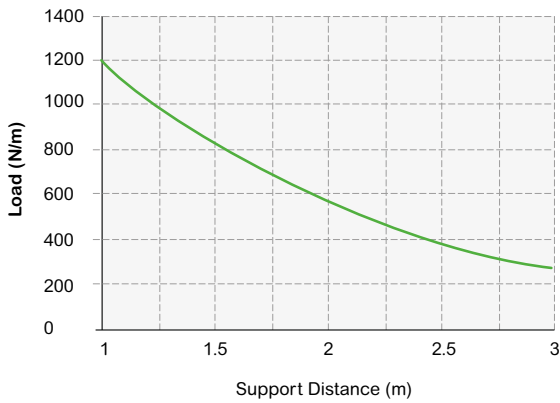

Cable Duct 110x200

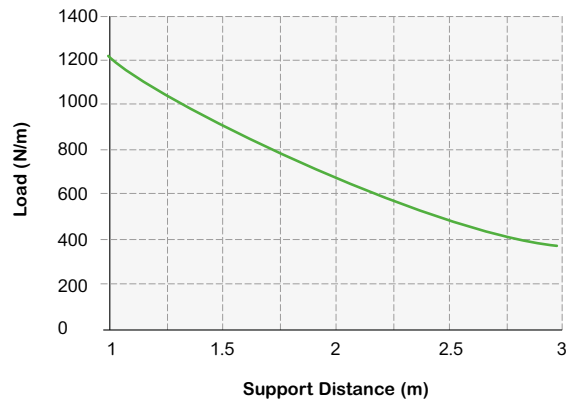

Cable Duct 60x300

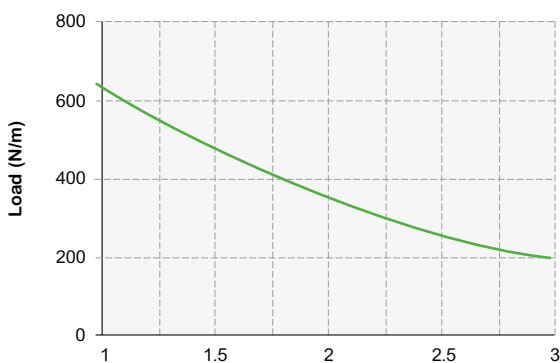

Cable Duct 110x300

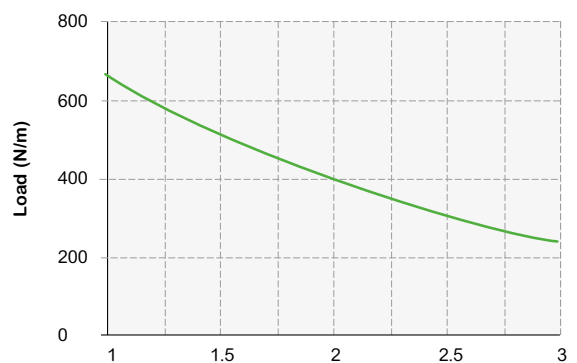

Stago Fibre-Optic Duct

Support working Loads
and Span recommendations

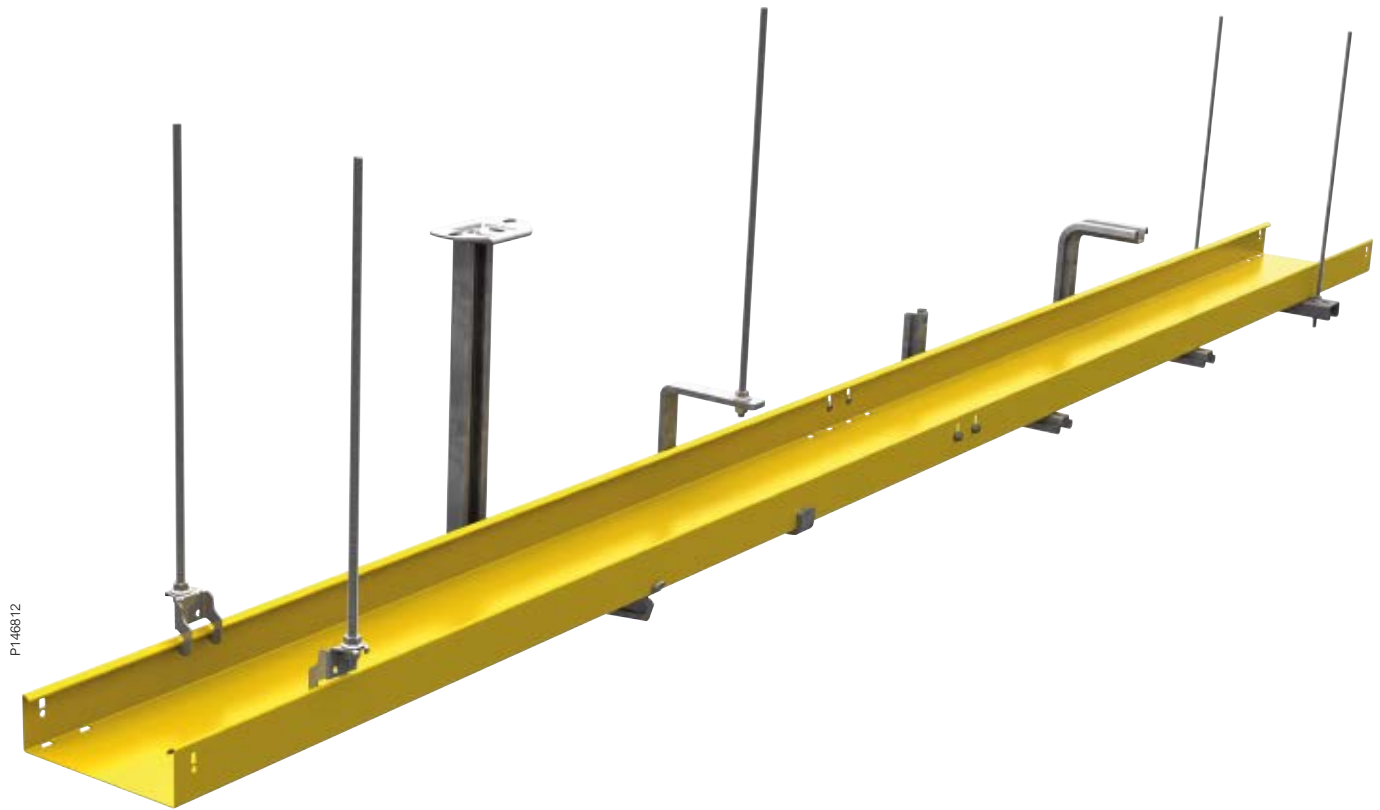

P146812

Support Width (mm)	Supports SWL (Kg)				
	Pendant 2F + Cantilever 50i	C-Bracket	Omega Wall Bracket	Omega Ceiling Bracket	Suspension Beam
100	230.2	20.9	198	123	200
200	160.4	72.6	100	90	200
300	123.1	75.6	78	75	200

Maximum recommended Span (considering Fibre-Optic cables)					
CRITERIA: Minimum of MPL/SWL	Pendant 2F + Cantilever 50i	C-Bracket	Omega Wall Bracket	Omega Ceiling Bracket	Suspension Beam
60x100	3	3	3	3	3
60x200	3	3	3	3	3
60x300	3	3	3	3	3
110x100	3	3	3	3	3
110x200	3	3	3	3	3
110x300	3	3	3	3	3

Stago Fibre-Optic Duct

Dimensions

Bend 90°

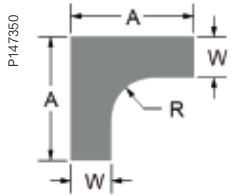

Cat. No.	Dimensions				Weight
	H	W	R	A	Kg
CSU08616109FS123	60	100	100	304.5	0.98
CSU08616209FS123	60	200	100	404.5	1.65
CSU08616309FS123	60	300	100	505.5	2.47
CSU08611109FS123	110	100	100	304.5	1.35
CSU08611209FS123	110	200	100	404.5	2.09
CSU08611309FS123	110	300	100	505.5	2.99

X-piece

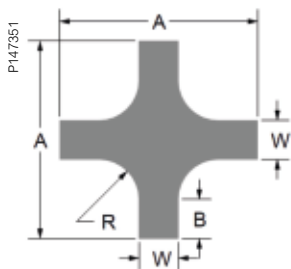

Cat. No.	Dimensions					Weight
	H	W	R	A	B	Kg
CSU08636109FS123	60	100	100	505.5	100.5	1.70
CSU08636209FS123	60	200	100	605.5	100.5	2.57
CSU08636309FS123	60	300	100	705.5	100.5	3.60
CSU08631109FS123	110	100	100	505.5	100.5	2.24
CSU08631209FS123	110	200	100	605.5	100.5	3.11
CSU08631309FS123	110	300	100	705.5	100.5	4.14

Universal Branching Piece

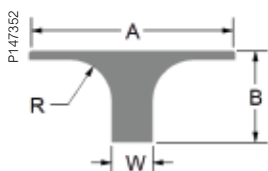

Cat. No.	Dimensions					Weight
	H	W	R	A	B	Kg
CSU08716109FS123	60	100	100	505.5	224	0.77
CSU08716209FS123	60	200	100	605.5	224	0.96
CSU08716309FS123	60	300	100	705.5	224	1.16
CSU08711109FS123	110	100	100	505.5	224	1.04
CSU08711209FS123	110	200	100	605.5	224	1.23
CSU08711309FS123	110	300	100	705.5	224	1.43

Stago Fibre-Optic Duct

Dimensions

T-piece

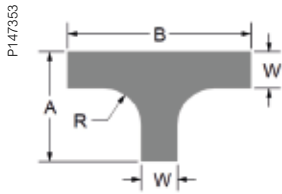

Cat. No.	Dimensions					Weight
	H	W	R	A	B	Kg
CSU08626109FS123	60	100	100	304.5	505.5	1.32
CSU08626209FS123	60	200	100	404.5	605.5	2.09
CSU08626309FS123	60	300	100	505.5	705.5	3.02
CSU08621109FS123	110	100	100	304.5	505.5	1.79
CSU08621209FS123	110	200	100	404.5	605.5	2.59
CSU08621309FS123	110	300	100	505.5	705.5	3.56

Reducer X-piece

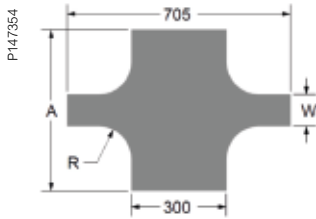

Cat. No.	Dimensions					Weight
	H	W	R	A	Kg	
CSU0863610309FS123	60	100	100	505.5	2.49	
CSU0863620309FS123	60	200	100	605.5	3.05	
CSU0863110309FS123	110	100	100	505.5	3.03	
CSU0863120309FS123	110	200	100	605.5	3.59	

Reducer

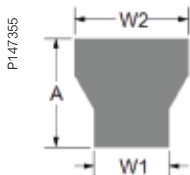

Cat. No.	Dimensions				Weight
	H	W1	W2	A	Kg
CSU082610209FS123	60	100	200	286	0.73
CSU082610309FS123	60	100	300	373	1.09
CSU082620309FS123	60	200	300	286	0.95
CSU082110209FS123	110	100	200	286	0.95
CSU082110309FS123	110	100	300	373	1.39
CSU082120309FS123	110	200	300	286	1.17

Stago Fibre-Optic Duct

Dimensions

Duct

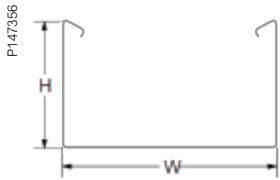

Cat. No.	Dimensions		Weight
	H	W	Kg
CSU7600104FS123	60	100	5.80
CSU7600204FS123	60	200	8.22
CSU7600304FS123	60	300	10.6
CSU7100104FS123	110	100	8.22
CSU7100204FS123	110	200	10.6
CSU7100304FS123	110	300	13.0

Duct cover

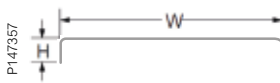

Cat. No.	Dimensions		Weight
	H	W	Kg
CSU0816113FS123	11	100	1.57
CSU0816303FS123	11	200	2.87
CSU0816433FS123	11	300	5.17

Drop-off UDF

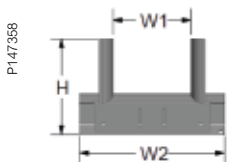

Cat. No.	Dimensions			Weight
	H	W1	W2	Kg
CSU0868059FS123	133	57.5	150	0.56
CSU0868109FS123	133	107.5	200	0.79
CSU0868259FS123	133	257.5	350	1.22

Stago Fibre-Optic Duct

Dimensions

Internal Riser

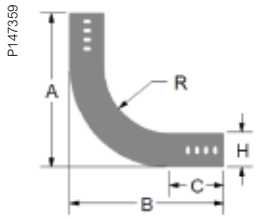

Cat. No.	Dimensions					Weight
	H	A	B	C	R	Kg
CSU08646109FS123	60	283	283	100	119	0.67
CSU08646209FS123	60	283	283	100	119	1.31
CSU08646309FS123	60	283	283	100	119	1.94
CSU08641109FS123	110	333	333	100	119	1.84
CSU08641209FS123	110	333	333	100	119	2.47
CSU08641309FS123	110	333	333	100	119	3.40

External Riser

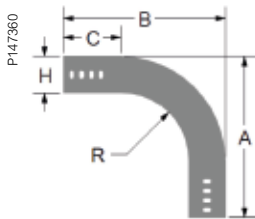

Cat. No.	Dimensions					Weight
	H	A	B	C	R	Kg
CSU08666109FS123	60	283	283	100	119	0.57
CSU08666209FS123	60	283	283	100	119	1.14
CSU08666309FS123	60	283	283	100	119	1.71
CSU08661109FS123	110	333	333	100	119	0.99
CSU08661209FS123	110	333	333	100	119	1.56
CSU08661309FS123	110	333	333	100	119	2.13

C-bracket

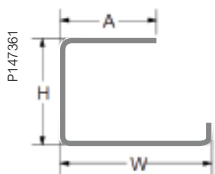

Cat. No.	Dimensions			Weight
	H	W	A	Kg
CSU08173109	153	100	82	0.38
CSU08173209	153	200	136	0.94
CSU08173309	153	300	188	1.53

Stago Fibre-Optic Duct

Dimensions

Omega Bracket "L"



Cat. No.	Dimensions			Weight
	H	W	A	Kg
4550310	131	159	23	0.32
4550320	131	259	23	0.45
4550330	131	359	23	0.57

Omega Bracket "C"

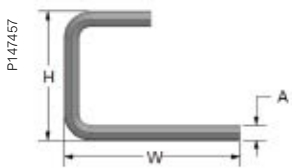

Cat. No.	Dimensions			Weight
	H	W	A	Kg
4550410	196	159	23	0.76
4550420	196	259	23	0.51
4550430	196	359	23	0.63

Vertical Piece 2F

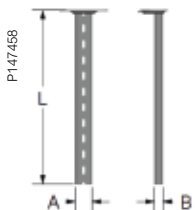

Cat. No.	Dimensions			Weight
	L	A	B	Kg
717196	280	48	24	0.80
717197	370	48	24	0.98
717198	505	48	24	1.26
717199	730	48	24	1.71
717200	1000	48	24	2.25
787276	1500	48	24	2.90

Stago Fibre-Optic Duct

Dimensions

Claw

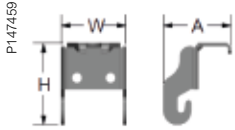

Cat. No.	Dimensions			Weight
	H	W	A	Kg
CSU08150209	57	46	48	0.05

Patch panel & RJ45 brackets

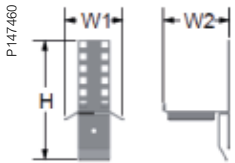

Cat. No.	Dimensions			Weight
	H	W1	W2	Kg
CSU0829A01FS905	150	74	84	0.19
CSU0829A02FS905	150	74	84	0.19

Cantilever Arm 50i



Cat. No.	Dimensions			Weight
	H	W1	W2	Kg
791412	85	150	43	0.19
791413	85	250	43	0.29
791414	110	350	43	0.46

Closed & Openable Tube

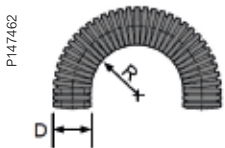

Cat. No.	Dimensions			Weight
	L	D	R	Kg
CSU0868A03FS905	2500	54.2	200	5.62
CSU0868A02FS905	2500	54.2	200	6.57

Mounting guide



P147339

Mounting guide

Mounting instructions	26
Modular Drop-Off UDF	26
External Coupler	26
Universal Cover Clip	26
Unilock Coupler	27
Modular Cover	27
90° Bend	27
Earthing Kit	28
Magnetic Universal Bobbin	28

Modular Drop-Off UDF

Clip-on modular Drop-Off can be fitted at any desired position on the lateral of the ducts to ensure full flexibility in guiding fibre-optic cables from the duct to the rack/cabinets.

The same principle of installation the Patch Panel Bracket and the Keystone RJ45.

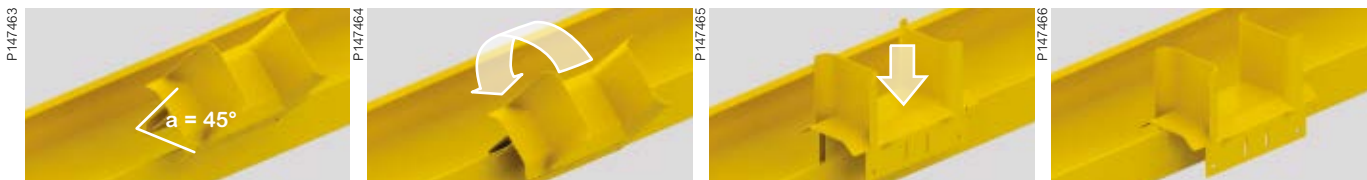

Step 1

Approach the lateral of the Cable Duct with the Drop-Off on a 45° angle.

Step 2

With the Drop-Off in contact with the Cable Duct then rotate until reaching perpendicularity.

Step 3

Insert the Drop-Off in a top/down direction.

Step 4

Press drop-off firmly to fix its position.

External Coupler

The External Coupler for systems H60 and H110 is the bolted solution to join 2 lengths of Cable Duct. The principle of installation presented below is applicable to system H60. For the case of the system H110 the installer should use four assembly kits per External Coupler. The assembly kit is created by the installer and should consist of bolts M6, Nuts M6, and Star washers M6. The quantity required is driven by the component to fix on.

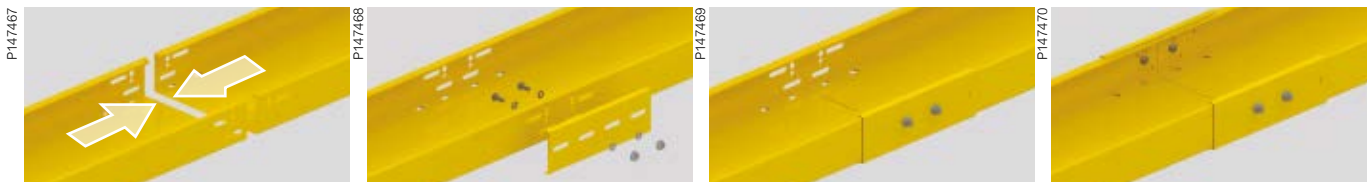

Step 1

Put together the perforated ends of two Cable Ducts.

Step 2

Use two assembly kits to mount one External Coupler..

Step 3

Tighten the nut till the star washer is in contact with the metal surface.

Step 4

Repeat steps 2 and 3 to install External Coupler in the other side of the Cable Duct.

Universal Cover Clip

Universal Cover Clip for snap-on fixation of the covers.

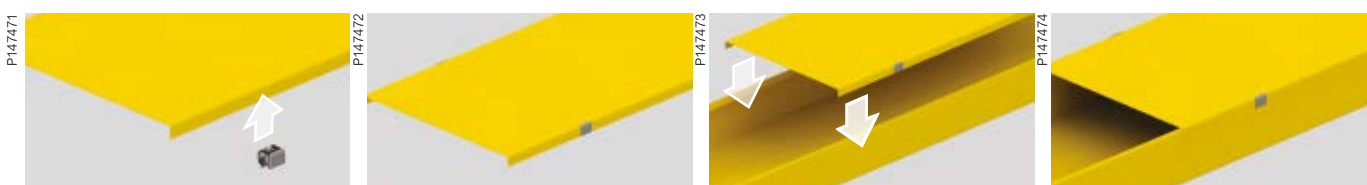

Step 1

Insert the Universal Cover Clip in the return flange of the cover.

Step 2

Mount four Universal Cover Clips per each cover of 2 meters length (preferably on the extremes of the cover).

Step 3

Place cover on top of the duct.

Step 4

Press firmly downward until the cover is fixed properly.

Unilock Coupler

Screwless snap-in internal coupler for system height 60 to be used to joint two lengths of Cable Duct (solution available only for system height 60).

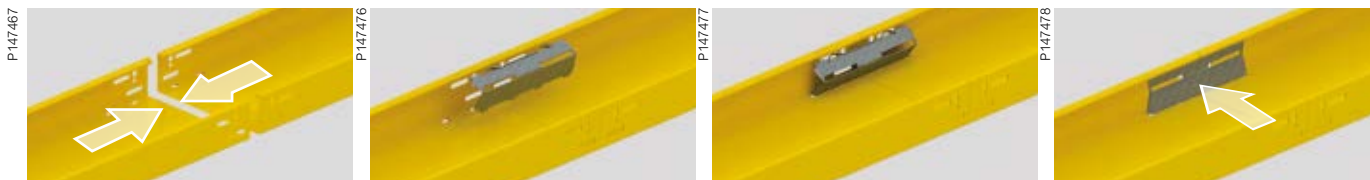

Step 1

Put together the perforated ends of two Cable Ducts.

Step 2

Work with only one pre-bent screwless internal coupler at a time.

Step 3

Position the four pins of the internal coupler in the four aligned holes of the Cable Duct.

Step 4

Press the internal coupler till the top part slides inside of the return flange of the Cable Duct.

Modular Cover

Modular cover piece can be fitted at any desired position on lengths to enhance cable protection at drop-out points.

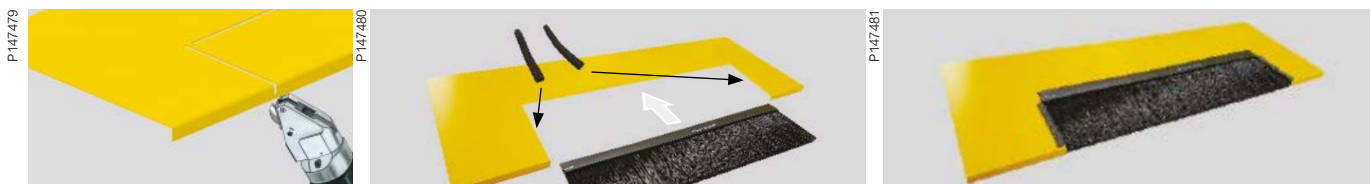

Step 1

Remove the pre-cutted area to open a window where the brush and protective strip can be located.

Step 2

Prepare two pieces of Protection Strip (85 mm) and insert them on both laterals of the open window.

Step 3

Fix the Modular Brush Gasket in the longer edge of the open window. Use four Universal Cover Clips to fix the Modular Cover to the tray.

90° Bend

Can be used to construct 90° direction changes at any desired position in the Cable Duct.

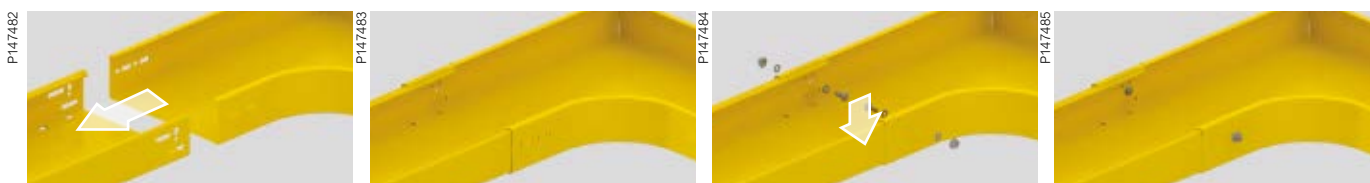

Step 1

Sleeve the 90° bend over the Cable Duct.

Step 2

Align the hole on the return flange of the 90° Bend with the end of the Cable Duct to position the fixation holes of the Duct and the Form Piece.

Step 3

Use one assembly kit per side to mount the 90° Bend on the Cable Duct.

Step 4

Tighten the nuts till the star washer is in contact with the metal surface.

Earthing Kit

Kit including earth wire with flat pin connectors and earthing clamps. Connect to 2 cover pieces to ensure electrical continuity between them. Delivered in a bag of 10 pieces.



Step 1

Place the 2 covers near to each other assuring sufficient space left for the clips.

Step 2

Snap the clips on the cover piece 1 piece per cover.

Step 3

Connect the wire to the clips.

Step 4

Close the gap between the covers.

Magnetic Universal Bobbin

Magnetic bobbin piece can be fitted at any desired position of the duct or form piece for a secure and smooth guidance of fibre-optic cables. Use 2 pieces on bobbin to safely store cable over-length.

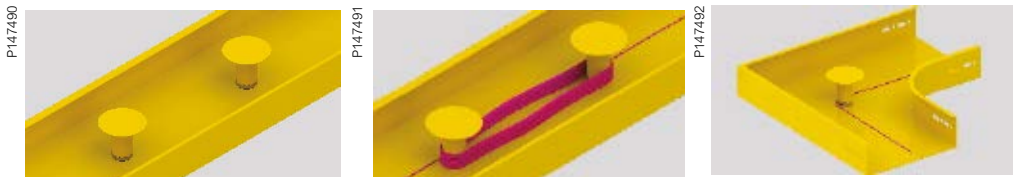

Step 1

For cable over-length function place 2 magnetic bobbin pieces on the bottom of the duct nearby each other.

Step 2

Gently wind the cables around the bobbins as seen in the picture.

Step 3

To use the bobbin piece as a bending radius extender place it on the bottom of the duct of form piece.

Notes

Customization handbook



Customization handbook

The possibility of customization	32
Cabe Duct length and width	32
Colors	33

The possibility of customization

Cable Duct length and width

Each and every data Centre is different. To adapt to some non standard necessities or special requirements Stago Fibre-optic duct system brings numerous customization options to the customers for an optimized installation.

The length of the Cable Duct can be customized by increments of 150 mm, being the shortest Cable Duct 1.5 meters and the biggest 6.3 meters.

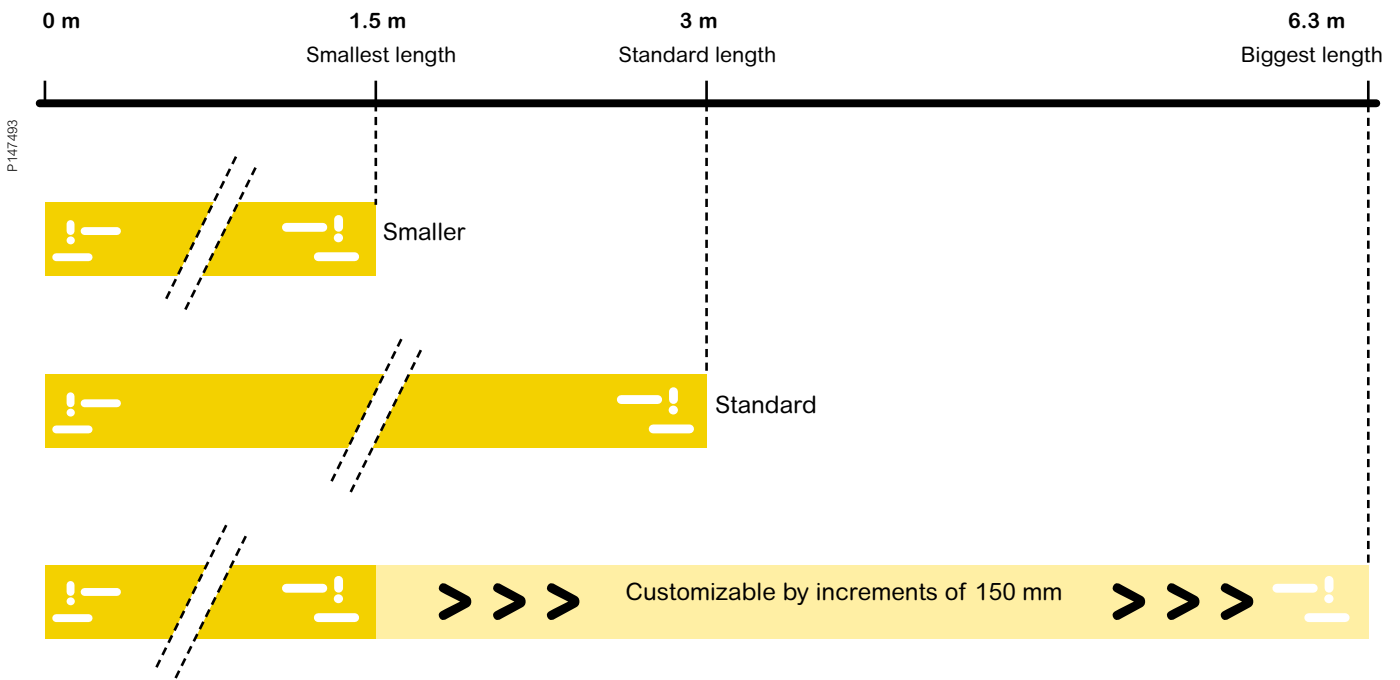

The width of the Cable Duct can also be tailored. Customers have the possibility to select from a large variety of system widths starting from 70 mm up to 600 mm.

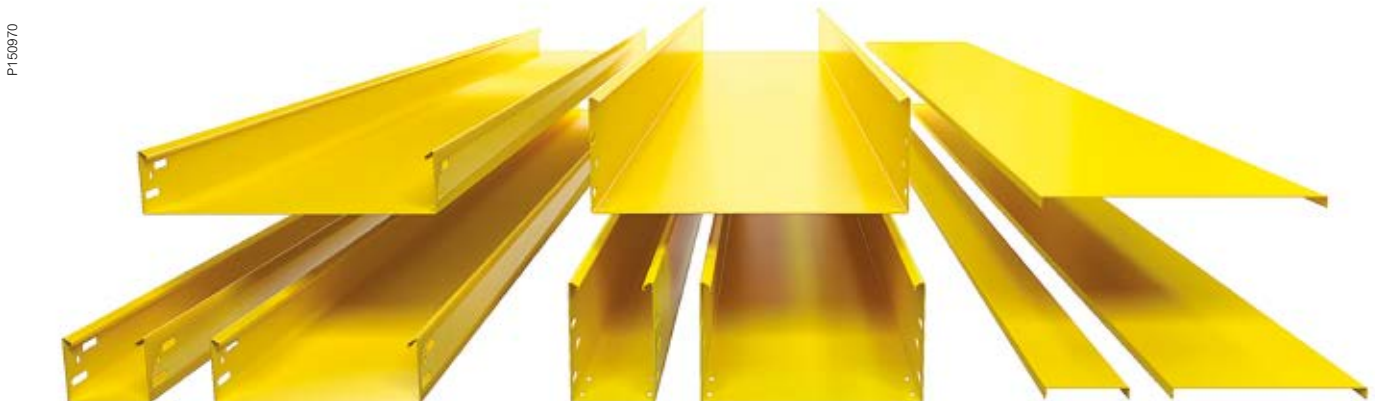

The possibility of customization

Colors

Colors may facilitate identification. By using non standard colors tracks can be easily distinguished and recognized. The Stago Fibre-optic duct system provides the possibility to produce in any preferred RAL color.

P147494

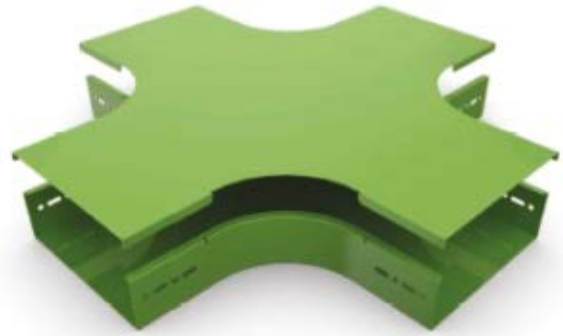
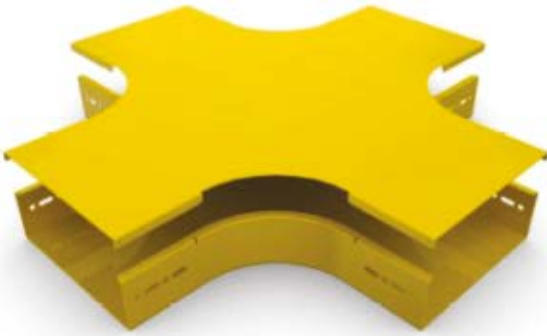

Security recommendations



Security recommendations

Electrical Continuity and Earthing	36
Combination 1	38
Combination 2 - 3 - 5 - 6	38
Combination 4	38

Schneider Electric recommendations	39
---	-----------

Electrical Continuity and Earthing

The standard IEC 61537 establishes that for Cable Ducts with Electrical Continuity characteristics (metal), this continuity should be guaranteed by means of an equipotential connection and one or several connections to earth in accordance with the use of the Cable Duct system.

The impedance must not exceed:

- 50 mΩ through the joint.
- 5 mΩ meter of cable duct

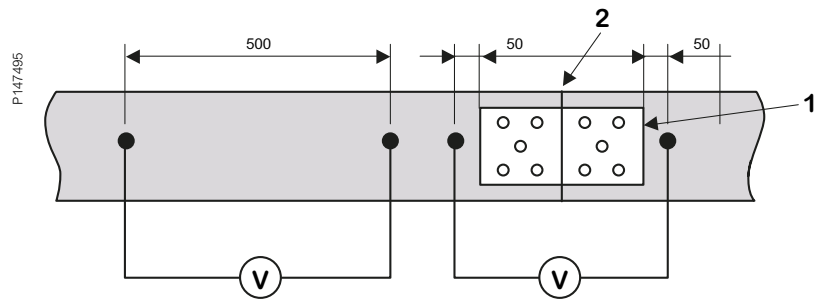

1. Coupling between Cable Duct sections
2. Joining two Cable Duct sections

Tray	Coupler	PG (mΩm)	PG with joint (mΩm)
Fibre-Optic Duct	Screwless joint (Unilock)	1.1	0.6
	Screwtype internal joint		1.6
	Screwtype external joint		1.4

The meter length and joining system for the different sections that Schneider Electric has, as well as the joints of the different accessories supplied, comply the electrical continuity test established in the aforementioned standard, guaranteeing the impedance established.

To guarantee these impedance values tightening torque values of no less than 5Nm are recommended, always using the jointing techniques recommended for the Fibre-Optic Duct System, and taking sizes into account.

To guarantee a safe installation, Schneider Electric recommends a proper earthing of all elements that make up the system (section and accessories), using the accessories designed specifically for this purpose.

SCHNEIDER ELECTRIC RECOMMENDS NOT TO USE THE DUCT AS EARTH OR NEUTRAL CONDUCTORS.

SCHNEIDER ELECTRIC IS NOT RESPONSIBLE OF ANY DAMAGE IF ACCESSORIES FROM OTHER MANUFACTURERS ARE USED. ESTABLISHING EARTH CONNECTION LIES UNDER THE RESPONSABILITY OF THE INSTALLER AND LOCAL REGULATIONS MUST BE TAKEN INTO ACCOUNT.

Electrical Continuity and Earthing

- Electrical continuity at every connection is guaranteed with 4 star washers, two per coupler (1 at the bolt and another on the nut's side).
- The star/scratch washers damage the power coating and connect all metallic components. In case of screwless jointing, the star washers are not necessary.
- To secure electrical continuity throughout the system apply a minimum of 5N/m torque when tightening the washers.

The elements in the Fibre-Optic Duct System recommended to guarantee the electrical continuity are:

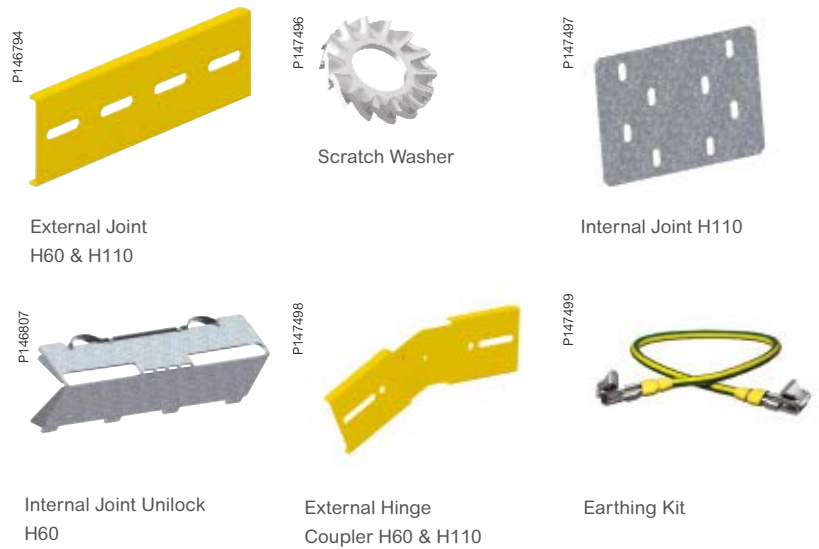

The picture below shows the combination between different elements in the Fibre-Optic Duct System where it is recommended to guarantee the electrical continuity. **As a general guideline it is recommended to use star washers on all painted surfaces.**

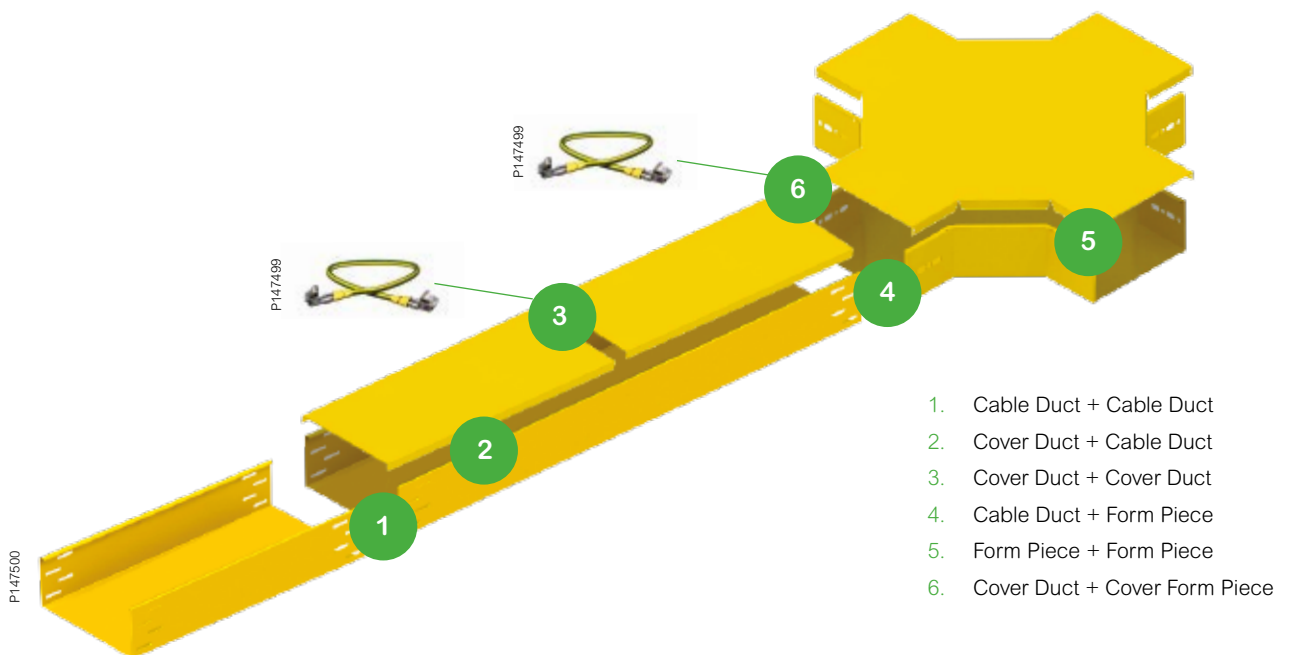

Electrical Continuity and Earthing

Combination 1

Depending on the height of the Cable Duct and the jointing technique used, the installer should follow different recommendations. The pictures below illustrates the different options.



Internal Joint Unilock H60

In this case the inside of the return flange of the Cable Duct is not painted with the purpose to benefit the Electrical Continuity when the top part of the Unilock is in contact with two ends of the Cable Duct.



External Joint H60

When using the External Joint for H60 the installer should use 2 scratch washers per set Bolt&Nut, one between the bolt and the Cable Duct and the other between the Joint and the nut.

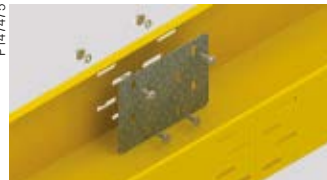

Internal Joint H110

When using the Internal Joint for H110 the installer should use 1 scratch washer per set Bolt&Nut. The washer must be placed between the nut and the Cable Duct.

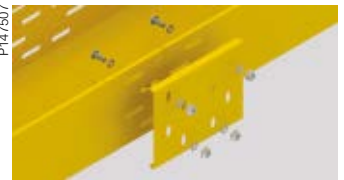

External Joint H110

When using the External Joint for H110 the installer should use 2 scratch washers per set Bolt&Nut, one between the bolt and the Cable Duct and the other between the Joint and the nut.

Combination 2-3-5-6

In all the combinations were the Covers are interacting, in order to guarantee the Electrical Continuity, it is recommended to use the Earthing Kit. Covers require a separate earthing to ensure electrical continuity throughout the system.



Step 1

Put together the perforated ends of two Cable Ducts.



Step 2

Manipulate one pre-bent screwless internal coupler at a time.



Step 3

Position the four pins of the internal coupler in the four aligned holes of the Cable Duct.



Step 4

Push the internal coupler till the top part is inside of the return flange of the Cable Duct.

Combination 4

In all combinations of Cable Duct and Form Pieces there is no need of extra jointing piece but the bolt set with two star washers .

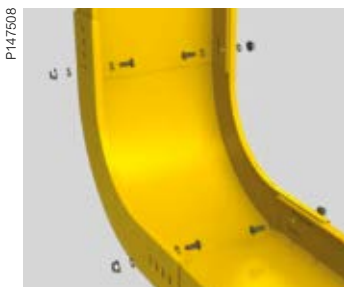

Form Piece H60

One set of Bolt&Nut with two scratch washers per each side to be connected.



Form Piece H110

Two sets of Bolt&Nut with two scratch washers per each side to be connected.

Schneider Electric recommendations

Schneider Electric recommends the use of appropriate Personal Protective Equipment (PPE) during transportation, installation and maintenance of Cable Support systems.

P147501



GLOVES

P147502



COVERALLS

P147503



STEEL TOE BOOTS

P147504



HELMET/HARD HAT

P147505



HIGH VISIBILITY VEST

P147506



**SAFETY GLASSES
WITH SIDE SHIELDS**

Life Is On



Schneider Electric Industries SAS

35 rue Joseph Monier
92500 Rueil-Malmaison, France
Tel : +33 (0)1 41 29 70 00

www.schneider-electric.com

September, 2017

LSB03161EN

©2017 Schneider Electric SE. All rights reserved.

All Schneider Electric trademarks and service marks are the property of Schneider Electric SE, its subsidiaries and affiliated companies.