

## KNX ARGUS Presence with light control and IR receiver

Operating instructions

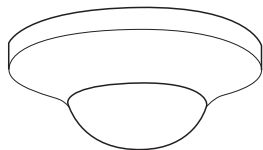

Art. no. MTN6309..

### Accessories

- Surface-mounted housing for ARGUS Presence (Art. no. MTN550619)

### For your safety



**DANGER**

**Risk of fatal injury from electrical current.**

All work carried out on the unit may only be performed by skilled electricians. Observe the regulations valid in the country of use, as well as the valid KNX guidelines.

### ARGUS introduction

The KNX ARGUS Presence with light control and IR receiver (called **ARGUS** in the following) is a KNX presence detector for interior ceiling mounting. It detects smaller movements within a circumference of 360° and a radius of 7 m (at a mounting height of 2.5 m).



The specified ranges refer to average conditions for the recommended mounting height and are therefore guide values. The range and sensitivity can vary greatly when the temperature fluctuates.

When movement is detected, a data telegram defined by the programming is transmitted and then evaluated to control the lighting, blinds, or heating, for example.

The ARGUS presence function continuously adjusts for brightness in the room. If sufficient natural light is available, the device will switch the artificial light off even if a person is present. The overshoot time can be adjusted using the ETS. The integrated light sensor continually measures the brightness level and processes this information in the application. In addition, it is possible to measure the brightness with an external light sensor and have it evaluated.

Light control enables the required brightness set in the ETS to be achieved permanently. Dimming and the optional use of a second lighting group maintains a constant brightness.

The functions of the IR receiver are specified by the application. The following functions can be carried out with a suitable IR remote control (e.g. Art. no. MTN570222).

- Change individual configurations of the ARGUS.
- Remote control of other KNX devices.



The IR receiver of the ARGUS can manage up to 50 channels. Suitable assignment is made in the ETS.

The ARGUS also has four movement sensors. You can set their sensitivity and range sector-specifically in the ETS.

The device is designed for use in offices, schools, public buildings or at home, for example. It is intended for ceiling mounting in a No. 60 mounting box, and can also be mounted on the ceiling in the surface-mounted housing for ARGUS Presence. The ARGUS has an integrated bus coupler and its power is supplied via KNX.

### Using ARGUS with alarm systems



Movement/presence detectors are not suitable for use as components of an alarm system.



Movement/presence detectors can trigger false alarms if the installation site has been chosen unfavourably.

Movement/presence detectors switch on as soon as they detect a moving heat source. This can be a person, but also animals, trees, cars or differences in temperature in windows. In order to avoid false alarms, the chosen installation site should be such that undesired heat sources cannot be detected (see section „Selecting the installation site“).

### Connections, displays and operating elements

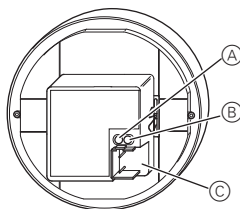

- (A) Programming button
- (B) Programming LED
- (C) Bus connecting terminal

### Alignment of the movement sensors (A, B, C, D)

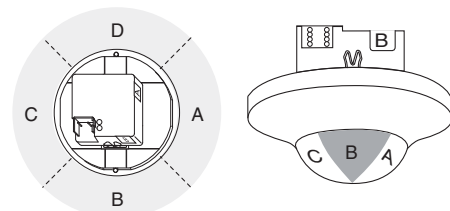

### Selecting the installation site

When selecting a suitable installation site, you should take a number of factors into account so that the ARGUS operates optimally.

- The shorter the distance between the detected person and the ARGUS, the better smaller movements are detected.
- When a person is walking, a larger area of detection is available. The reference level for the detection is the floor.
- The mounting height has a direct effect on the range and sensitivity of the ARGUS. The optimal mounting height is 2.5 m.

The following diagram shows the ranges of the ARGUS. They are based on average temperature conditions at a mounting height of 2.5 m. The range of a movement detector can fluctuate considerably at variable temperatures.

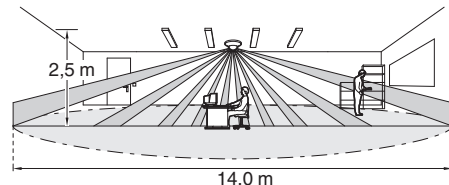

Mounting height	Area of detection
2.0 m	11 m
2.5 m	14 m
3.0 m	17 m

- The position of the ARGUS in regard to the direction of movement also affects detection. If possible, install the movement detector sideways to the direction of movement.

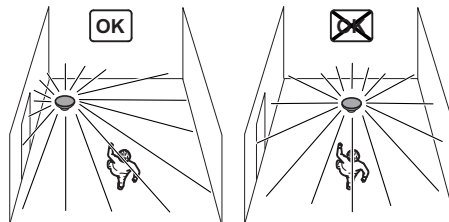

- If you wish to attach several presence detectors, install them so that the detection areas of the individual devices intersect each other.
- The ARGUS is designed for permanent installation only. Mount the ARGUS on a fixed base only to avoid faulty operation caused by the movement of the detector.
- To prevent undesired load switching, do not mount the switched luminaire directly in the detection area of the ARGUS.
- Avoid mounting the device above a luminaire (e.g. standard lamp). The heat radiation of the luminaire can influence the function of the ARGUS. Brightness can no longer be measured when there is direct light incidence. If luminaires are mounted in the ARGUS detection area, a distance of at least 3 m must be complied with when the connection load is high.

## ARGUS installation

**i** The retaining ring and thus the movement sensors themselves can only be rotated in 90° increments. To optimally adjust the movement sensors to the movement in the space, you have to align the installation boxes or the surface-mounted housing appropriately when mounting.

- 1 The ARGUS is connected via a bus connecting terminal and snapped onto the retaining ring.

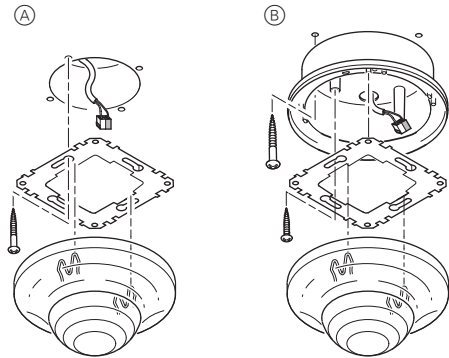

- (A) Flush-mounted installation  
(B) Surface-mounted installation

For flush-mounted installation, the retaining ring included with supply is fixed with two screws to a size 60 installation box. For surface mounting, the retaining ring is mounted in the surface-mounted housing which is available as an accessory.

## Putting ARGUS into operation

- 1 Press the programming button.

The programming LED lights up.

- 2 Load the physical address and application into the device from the ETS.

The programming LED goes out.

The application has been loaded successfully, the device is ready for operation.

## Setting ARGUS

### Setting the movement sensors

The ARGUS has four movement sensors (A, B, C, D). You can set their sensitivity and range sector-specifically in the ETS.

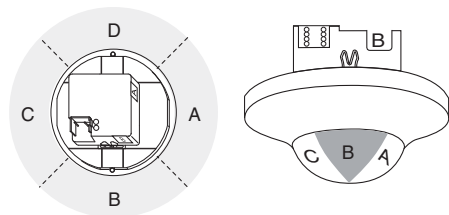

## Technical data

Nominal voltage:	DC 24 V (+6 V / -4 V)
KNX connection:	Bus connecting terminal
Current consumption:	max. 8 mA
Angle of detection:	360°
Number of levels:	6
Number of zones:	136 with 544 switching segments
Number of movement sensors:	4, separately adjustable
Recommended mounting height:	2 m - 5 m, optimum 2.50 m
Light sensor:	infinitely adjustable in ETS between approx. 10 and 2000 lux In general, the values measured by the sensor deviate from the lighting conditions at the main place of usage (e.g. work surface). The extent of the deviation is dependent on the installation site of the sensor, the properties of the room (reflection of the luminaires, type of paint on the walls and the surfaces) and the luminaires used.
Range:	Radius of approx. 7 m; can be set in ETS
Overshoot time:	from 1 s to 255 hours; can be set in the ETS
Display elements:	1 red programming LED
Operating elements:	1 programming button
Number of IR channels:	10 for controlling other KNX devices, 10 for configuration (channel numbers 1 - 50)
IR operator panels:	e.g. IR remote control Art. no. MTN570222
Ambient temperature	
Operation:	-5 °C to +45 °C (at temperatures > 30 °C, movement detection is limited)
Storage:	-25 °C to +45 °C
Transport:	-25 °C to +70 °C
EC guidelines:	EMC guideline 89/336/EEC
Initialisation:	Due to the limitation of the telegram rate, a telegram cannot be generated until 20 seconds after initialisation at the earliest.
Type of protection:	IP 20

**i** When using the IR function, a separation of the IR channels must be noted. When installing several devices in one area, either a different channel should be parameterised for each device or there is only one central device for processing IR commands.

## Schneider Electric Industries SAS

If you have technical questions, please contact the Customer Care Center in your country.

[www.schneider-electric.com](http://www.schneider-electric.com)

This product must be installed, connected and used in compliance with prevailing standards and/or installation regulations. As standards, specifications and designs develop from time to time, always ask for confirmation of the information given in this publication.