

LUFFP9 Telemecanique

User's Manual

Gateway
DeviceNet / Modbus RTU



- Merlin Gerin
- Modicon
- Square D
- Telemecanique



Table of Contents

Safety Information	4	5. Gateway Initialization and Diagnostics	40
Disclaimer	4	5.1. Full Management	40
About the Book	5	5.1.1. DeviceNet Master Command Word	40
1. Introduction	6	5.1.2. Gateway Status Word	41
1.1. Introduction to the User's Manual	6	5.2. Diagnostic Only	41
1.2. Introduction to the LUFP9 Gateway	8	5.2.1. DeviceNet Master Command Word	41
1.3. Terminology	8	5.2.2. Gateway Status Word	42
1.4. Introduction to the Communication "System" Architecture	9	5.3. Simplified Operation	42
1.5. Principle of Gateway Configuration and Operation	10	5.4. Description of the DeviceNet Master Command Word	43
2. Hardware Implementation of the LUFP9		5.5. Description of the Gateway Status Word	45
Gateway	12	6. Configuring the Gateway	47
2.1. On Receipt	12	6.1. Connecting the Gateway to the Configuration PC	47
2.2. Introduction to the LUFP9 Gateway	12	6.1.1. Pin Outs	48
2.3. Mounting the Gateway on a DIN Rail	13	6.1.2. RS-232 link protocol	48
2.4. Powering the Gateway	14	6.2. Installing ABC-LUFP Config Tool	49
2.5. Connecting the Gateway to the Modbus Network	14	6.3. Importing the Gateway Configuration	49
2.5.1. Examples of Modbus Connection Topologies	14	6.4. Transferring a Configuration to the Gateway	50
2.5.2. Pin outs	17	6.5. Monitoring the Content of the Gateway's Memory	50
2.5.3. Wiring Recommendations for the Modbus Network	18	6.6. Deleting a Modbus Slave	52
2.6. Connecting the LUFP9 Gateway to the DeviceNet Network	20	6.7. Adding a Modbus Slave	53
2.7. Configuring DeviceNet Communication Features	21	6.8. Changing Periodic Data Exchanged With a Modbus Slave	55
2.7.1. Encoding DeviceNet Speed	21	6.8.1. Replacing a Periodic Input Data Element	55
2.7.2. Encoding the Gateway Address	22	6.8.2. Replacing a Periodic Output Data Element	56
2.7.3. Sample Gateway Configurations	23	6.8.3. Increasing the Amount of Periodic Input Data	57
3. Signaling	24	6.8.4. Increasing the amount of periodic output data	61
4. Software Implementation of the Gateway	26	6.9. Deleting Aperiodic Parameter Data	66
4.1. Introduction	26	6.10. Changing a Modbus slave Configuration	68
4.1.1. System Architecture	26	6.10.1. Changing the Name of a Modbus Slave	69
4.1.2. Configuring the Motor Starters	27	6.10.2. Changing the Address of a Modbus Slave	69
4.1.3. Modbus Cycle Time	27	6.11. Adding and Setting Up a Modbus Command	70
4.1.4. Managing Degraded Modes With the Gateway Default Configuration	27	6.11.1. With TeSys U Motor Starters	70
4.2. Configuring the Gateway in RSNetWorx	32	6.11.2. With a Generic Modbus Slave	72
4.2.1. Selecting and Adding the Master PLC's DeviceNet Scanner	32	6.11.3. Adding a Special Modbus Command	86
4.2.2. Installing the Gateway Description File	32	6.12. Configuring the General Characteristics of the Gateway	88
4.2.3. Selecting and Adding a Gateway to the DeviceNet Network	33	6.12.1. "Fieldbus" Element	88
4.2.4. Editing Gateway Parameters	33	6.12.2. "ABC" Element	89
4.2.5. Configuring the DeviceNet Scanner	35	6.12.3. "Sub-Network" Element	90
4.2.6. Configuring Inputs from the Gateway	36	6.13. Adding a Broadcaster Node	92
4.2.7. Configuring Outputs Intended for the Gateway	37	Appendix A: Technical Characteristics	93
4.2.8. Transferring the DeviceNet Scanner Configuration	38	Appendix B: Default Configuration	96
4.2.9. Developing a DeviceNet Application	38	Appendix C: Practical Example (RSLogix 500) ...	99
4.3. Description of Services Assigned to Gateway I/O	38	Appendix D: DeviceNet Objects	108
		Appendix E: Modbus Commands	127
		Index	131
		Glossary	132

Safety Information

NOTICE:

Read these instructions carefully, and look at the equipment to become familiar with the device before trying to install, operate, or maintain it. The following special messages may appear throughout this documentation or on the equipment to warn of potential hazards or call attention to information that clarifies or simplifies a procedure.



These are the safety alert symbols. They are used to alert you to potential personal injury hazards. Obey all safety messages following these symbols to avoid death, injury, or equipment damage.



DANGER

DANGER indicates an imminently hazardous situation, which, if not avoided, will result in death, serious injury, or equipment damage.

WARNING

WARNING indicates a potentially hazardous situation, which, if not avoided, can result in death, serious injury, or equipment damage.

CAUTION

CAUTION indicates a potentially hazardous situation, which, if not avoided, can result in injury or equipment damage.

Disclaimer

PLEASE NOTE:

Only qualified personnel should service electrical equipment. No responsibility is assumed by Schneider Electric for any consequences arising out of the use of this material or the associated User Manual. This document is not intended as an instruction manual for untrained persons.

© 2005 Schneider Electric. All Rights Reserved.

About the Book

Validity Note

The data and illustrations in this manual are not contractual. We reserve the right to modify our products in line with our policy of continuous development. The information given in this document may be modified without notice and must not be interpreted as binding in the part of Schneider Electric.

Related Documents

Title of Documentation	Reference Number
AnyBus Communicator – User Manual	ABC_User_Manual.pdf
Safety Guidelines for the Application, Installation, and Maintenance of Solid State Control	NEMA ICS 1.1 (latest edition)
Safety Standards for Construction and Guide for Selection, Installation and Operation of Adjustable-Speed Drive Systems	NEMA ICS 7.1 (latest edition)
Modbus User Guide	TSX DG MDB E
Modicon Modbus Protocol Reference Guide	PI-MBUS-300 Rev. J

Product Related Information

Schneider Electric is in no way responsible for any errors in this document. Please contact us if you have any suggestions for improvements or modifications, or if you find any errors in this publication.

No parts of this document may be reproduced in any form or by any means whatsoever (electronic, mechanical or photocopying) without the prior authorization of Schneider Electric.

All pertinent state, regional, and local safety regulations must be observed when installing and using this product. For safety reasons and to ensure compliance with the documented system data, only the manufacturer should perform repairs to components.

User Comment

This is a “living” document. As such, it will be revised from time to time to add new content or to revise existing content as considered necessary. This manual has been written for you. We welcome your questions and comments about this document. Please send your comments by e-mail to techpub@schneider-electric.com

1. Introduction

1.1. Introduction to the User's Manual

- Chapter 1 Introduction** describes the gateway, the user guide that comes with it and the terms used in it.
- Chapter 2 Hardware Implementation of the LUF9 Gateway** gives an introduction to the gateway and describes all the items used when setting it up, both inside (thumb wheels) and outside (cables and connectors) the gateway.
- Chapter 3 Signaling** describes the six LEDs on the front of the gateway.
- Chapter 4 Software Implementation of the Gateway** describes the successive steps for setting the gateway up with its default configuration, with a PLC using DeviceNet. LUF9 gateways are shipped pre-configured to allow you to interface a DeviceNet master with 8 predefined Modbus slaves (TeSys U motor starters).
- Chapter 5 Gateway Initialization and Diagnostics** describes two registers in the gateway's memory reserved for initializing and carrying out diagnostics on the gateway. They are only exchanged between the DeviceNet master and the gateway.
- Chapter 6 Configuring the Gateway** describes how to use the "ABC-LUF9 Config Tool" software application, which allows you to modify or create a new configuration for the gateway and shows the various features of this software (add or remove a Modbus slave, add or change a Modbus command, etc.).
- This chapter also shows the changes to be made to software implementation operations in RSNetWorx.
- Appendix A Technical Characteristics** describes the technical aspects of both the gateway and the DeviceNet and Modbus RTU networks it is interfaced with.
- Appendix B Default Configuration** describes the main features of the default configuration of the LUF9 gateway. However, it does not go into ABC-LUF9 Config Tool in detail.
- Appendix C Practical Example (RSLogix 500)** gives a simple example using the LUF9 gateway's default configuration. This example exploits the command and monitoring registers for 8 TeSys U motor starters and uses the aperiodic read and write services to access the value of any motor starter parameter.
- Appendix D DeviceNet Objects** describes both the generic DeviceNet objects and the DeviceNet objects specific to the LUF9 gateway. The values of the attributes of these objects are also given.
- Appendix E Modbus Commands** describes the content of the Modbus command frames supported by the LUF9 gateway.

1. Introduction

Quick Access to Critical Information

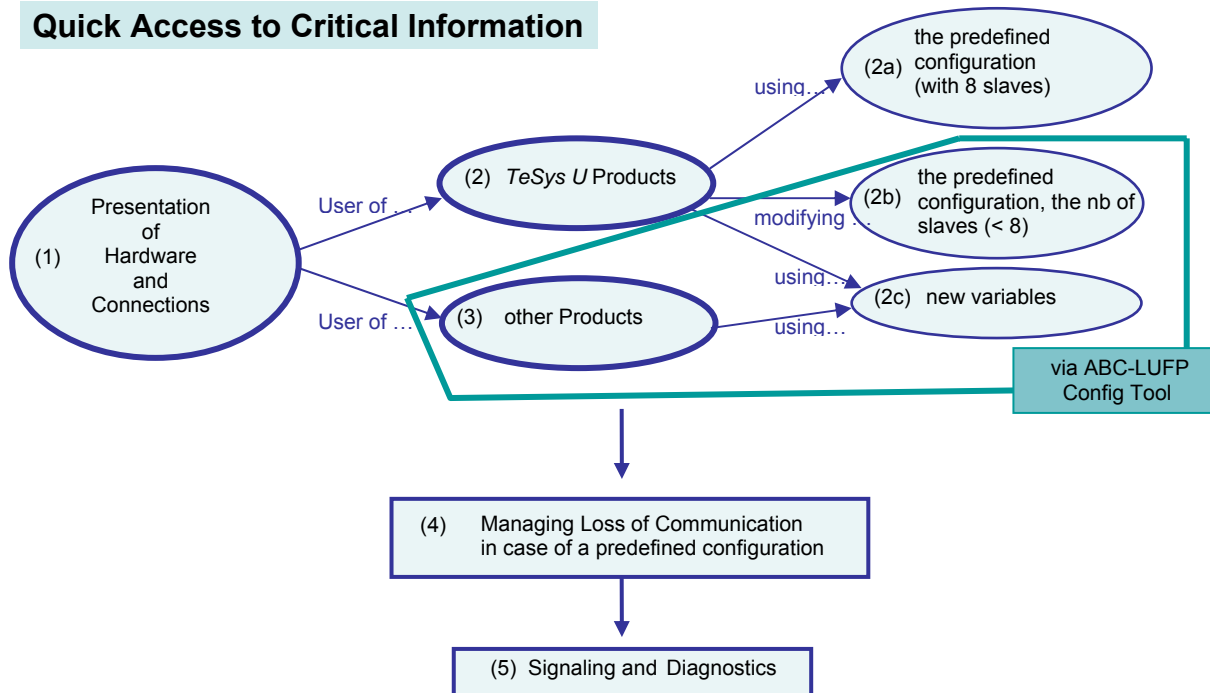

(1) Presentation of Hardware and Connections

- **See Chapter 2**
- powering,
 - mounting,
 - Modbus connecting,
 - DeviceNet connecting,
 - Transmission speed and address selecting

(2) User of TeSys U Products

(2a) with 8 slaves

- **See Chapter 4**

(2b) reducing the number of slaves

- **See Chapter 6**
- Using ABC-LUFP Config Tool:
- install (6.2),
 - connect (6.1),
 - remove slaves (6.6)

(2c) access to new variables

- **See Chapter 6**
- Using ABC-LUFP Config Tool to access other registers than standard 704 (Command) and 455 (Status)
- with the same request:
- replace a register with another (for instance 455 with 458)
 - expand the size (the number of registers)
- with a supplementary request:
- add-up extra commands
 - other operations (6.7 to 6.11)

(3) User of other Generic Modbus Products

- **See Chapter 6 (6.7 to 6.11, 6.11.2)**
- Select between:
- adapting the predefined configuration provided with the gateway, if close enough to that you wish (1 register to read and 1 to write, 1 register address to change), or
 - building up your own configuration from scratch (see ABC User Manual)

(4) Loss of Communication

- **See Chapter 4.1.4.1 and Chapter 6.11.2.2**
- The variables described are:
- **Reconnect time** (unit = 10ms, default value = 10s)
 - **Retries** (default value = 3)
 - **Timeout time** (unit = 10ms, default value = 1s)

(5) Signaling of faults and status, Diagnostics

- **See Chapter 3**
- Signaling defaults and gateway status by LEDs on the front
- **See Chapter 5**
- Gateway initializing mode and description of diagnostics information

1. Introduction

1.2. Introduction to the LUF9 Gateway

The LUF9 gateway allows a master located on a DeviceNet network to enter into a dialogue with slaves on a Modbus RTU network. This is a generic protocol converter operating in a way which is transparent to the user.

This gateway allows you to interface many products marketed by *Schneider Electric* with a DeviceNet network. These include TeSys U motor starters, Altivar drives and Altistart soft start- soft stop units.

1.3. Terminology

Throughout this document, the term “user” refers to any person or persons who may need to handle or use the gateway.

The term “RTU”, which refers to the Modbus RTU communication protocol, will be omitted most of the time. As a result, the simple term “Modbus” will be used to refer to the Modbus RTU communication protocol.

As is still the case with all communication systems, the terms “input” and “output” are somewhat ambiguous. To avoid any confusion, we use a single convention throughout this document. So the notions of “input” and “output” are always as seen from the PLC, or the DeviceNet master / scanner.

Hence, an “output” is a command signal sent to a Modbus slave, whereas an “input” is a monitoring signal generated by this same Modbus slave.

The diagram below shows the flows of “inputs” and “outputs” exchanged between a DeviceNet master and Modbus RTU slaves via the LUF9 gateway:

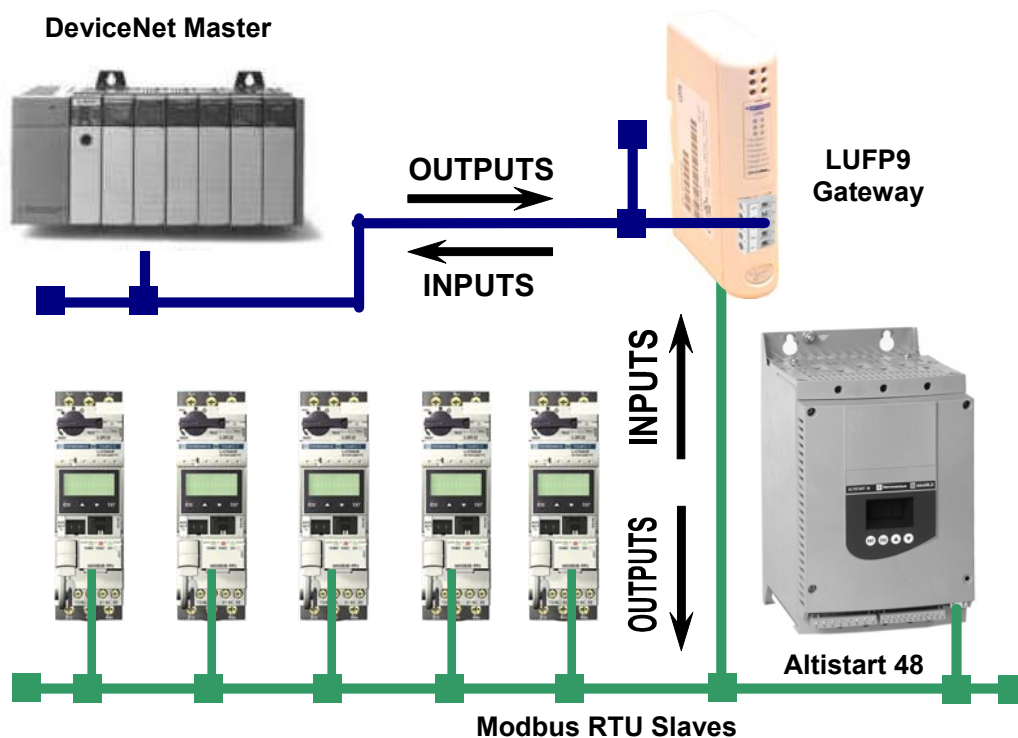

NOTE: For more explanation about specific terms, refer to the Glossary at the end of this guide.

1. Introduction

1.4. Introduction to the Communication “System” Architecture

Each LUF9 DeviceNet / Modbus RTU gateway allows a PLC on the DeviceNet network to command, control and configure up to 8 Modbus slaves. 25 commands can be distributed over a maximum of 8 slaves, without any time constraint. If there are more than 8 Modbus slaves, you will need to use an appropriate number of LUF9 gateways.

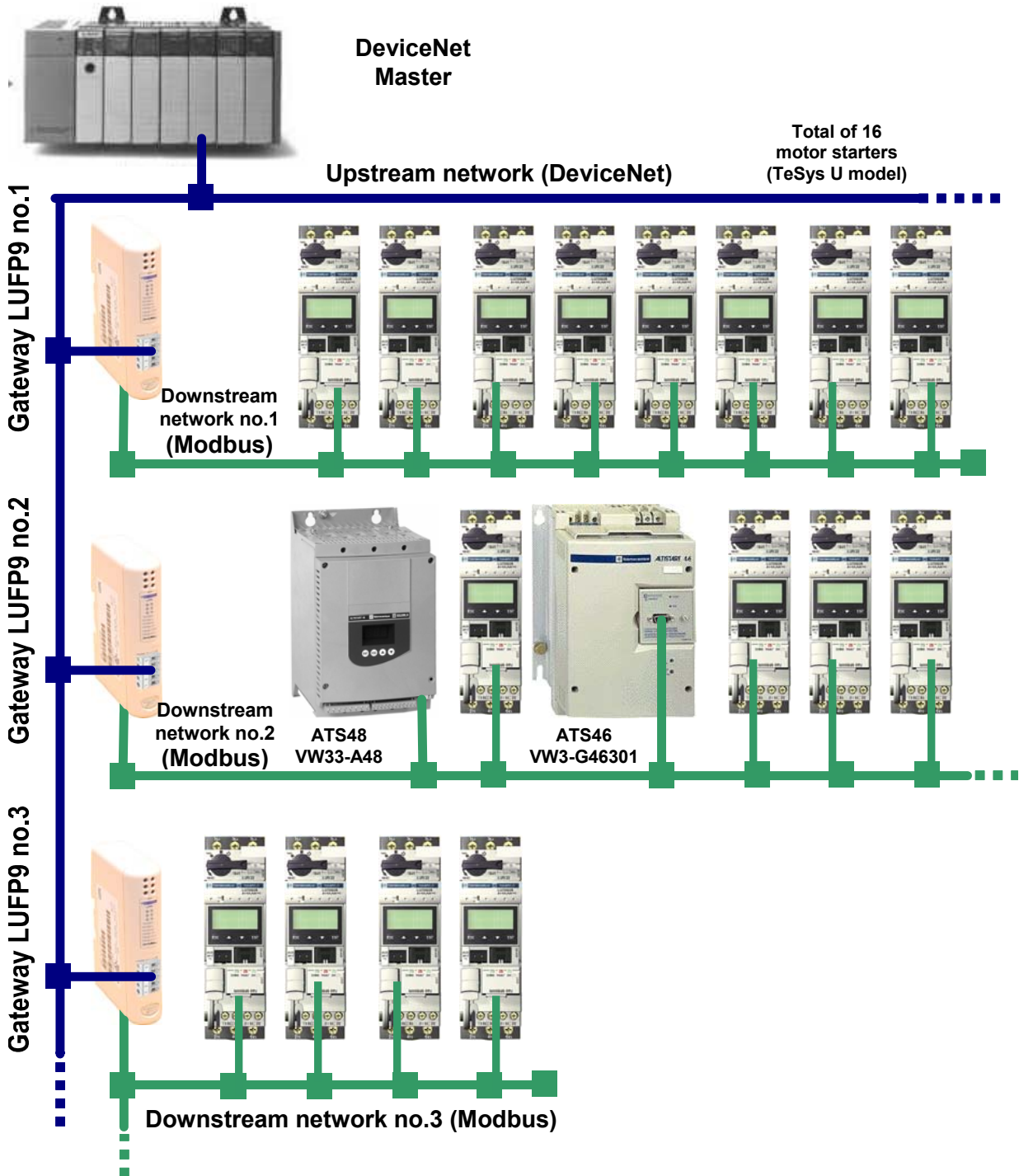

1. Introduction

The LUFP9 gateway behaves both as a DeviceNet slave on the upstream network and as a Modbus RTU master on the downstream network.

See Appendix A: Technical Characteristics, if you would like to read about the technical communication characteristics of the LUFP9 gateway.

The gateway can carry out its data exchanges (inputs and outputs of all types) with the Modbus slaves cyclically, aperiodically or in an event-driven way. All of these Modbus exchanges make up the gateway's "Modbus scanner" and we use the "ABC-LUFP Config Tool" software application to configure this scanner's exchanges. Each item of data exchanged in this way is made available to the DeviceNet master, which can gain access to it in a number of ways (cyclical, aperiodic or event-driven exchanges).

NOTE: If, for example, a communication is periodic on the Modbus network, the corresponding data does not have to be exchanged periodically on the DeviceNet network and <i>vice versa</i> .

The diagram on the preceding page illustrates the distribution of several slaves over three downstream Modbus RTU networks, each of these networks being interfaced with the DeviceNet master PLC using an LUFP9 gateway.

1.5. Principle of Gateway Configuration and Operation

The LUFP9 gateway is part of a family of products (referred to as LUFP●) designed to meet generic needs for connection between two networks using different communication protocols.

The software elements common to all these gateways (a configuration tool known as "ABC-LUFP Config Tool" and the on-board Modbus software) cohabit with the specific features of the network upstream of each of them (DeviceNet in the case of the LUFP9 gateway) generically. This is one of the reasons why the interfacing between the upstream network and the Modbus network is carried out entirely via the gateway's physical memory.

⇒ The exchanges between the gateway (which operates as a Modbus master) and the Modbus slaves are wholly configured using ABC-LUFP Config Tool. This configuration tool goes into great detail (setting timers for exchanges, communication modes, frame content, etc.), which makes it all the more delicate to use. So a whole chapter in this guide (chapter 6 Configuring the Gateway) has been devoted to this tool.

1. Introduction

⇒ Each LUF9 gateway is shipped pre-configured so as to make it easier to operate and the factory settings can be used as a basis for a configuration which will best meet the user's expectations. The typical operations applicable to this default configuration are described in chapter 6 Configuring the Gateway.

The DeviceNet network is totally separate from the Modbus network. The frames on a network are not directly "translated" by the gateway to generate frames on the other network. Instead, the exchanges between the content of the gateway's memory and the Modbus slaves make up a system which is independent of the one which is entrusted with managing the exchanges between this same memory and the DeviceNet master. The system guarantees the coherence of data exchanged within the shared memory.

You must check that the size of the DeviceNet data corresponds to the size of the memory used for the Modbus exchanges, because the gateway configures its DeviceNet exchanges on the basis of the memory used by the Modbus frames. If the sizes do not match, the fieldbus Diag LED n°4 blinks at a 1 Hertz frequency, cyclic Modbus exchanges are enabled and write-access Modbus registers are set to 0.

The example which follows illustrates the independent management of each of the two networks:

— Managing Gateway ↔ Modbus slaves exchanges —

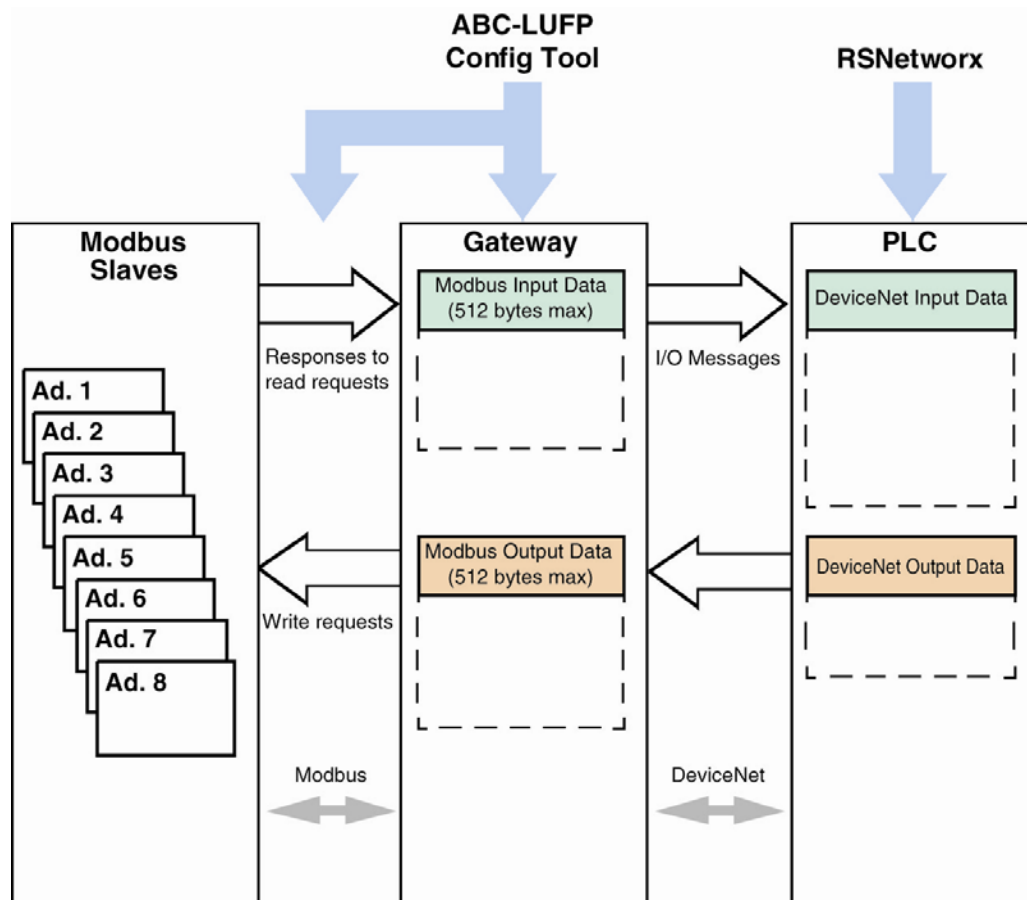

2. Hardware Implementation of the LUF9 Gateway

2.1. On Receipt

After opening the packaging, check that you have an LUF9 DeviceNet / Modbus RTU Gateway equipped with connectors.

2.2. Introduction to the LUF9 Gateway

The cables and other accessories for connecting to DeviceNet and Modbus networks need to be ordered separately.

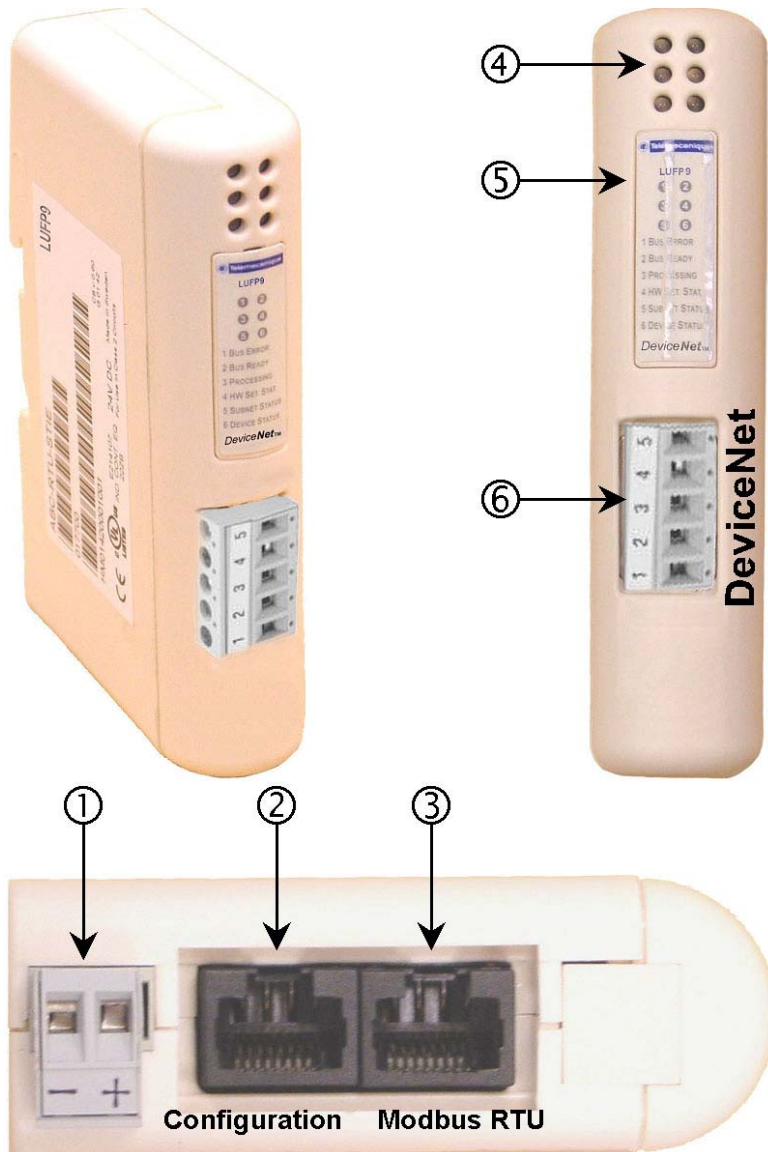

Legend:

- ① Detachable power connector for the gateway (24V).
- ② Female RJ45 connector to a PC running ABC-LUFP Config Tool configuration software.
- ③ Female RJ45 connector for the downstream Modbus RTU network.
- ④ Six diagnostic LEDs.
- ⑤ Removable cover for the selector switches used to configure the gateway, shown and described in chapter 2.7 Configuring DeviceNet Communication Features. The label describing the LEDs is stuck onto this cover.
- ⑥ Detachable female DeviceNet connector.

2. Hardware Implementation of the LUFPP9 Gateway

The LUFPP9 enables communications between a DeviceNet network and Modbus devices for the purpose of industrial automation and control. As with any component used in an industrial control system, the designer must evaluate the potential hazards arising from use of the LUFPP9 in the application.

⚠ WARNING

LOSS OF CONTROL

- The designer of any control scheme must consider the potential failure modes of control paths and, for certain critical control functions, provide a means to achieve a safe state during and after a path failure. Examples of critical control functions are emergency stop and overtravel stop.
- Separate or redundant control paths must be provided for critical control functions.
- System control paths may include communication links. Consideration must be given to the implications of unanticipated transmission delays or failures of the link.^a
- Each implementation of an LUFPP Gateway must be individually and thoroughly tested for proper operation before being placed into service.

Failure to follow this instruction may result in death, serious injury, or equipment damage.

^a For additional information, refer to NEMA ICS 1.1 (latest edition), "Safety Guidelines for the Application, Installation, and Maintenance of Solid State Control" and to NEMA ICS 7.1 (latest edition), "Safety Standards for Construction and Guide for Selection, Installation and Operation of Adjustable-Speed Drive Systems".

2.3. Mounting the Gateway on a DIN Rail

Mounting the gateway

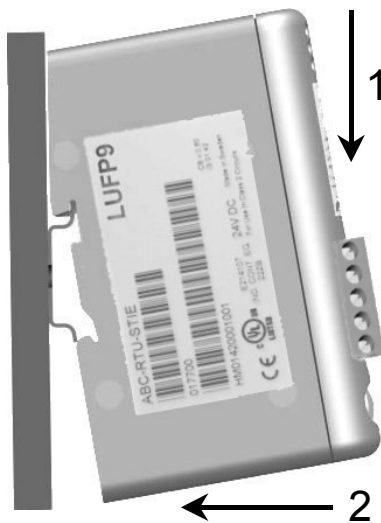

Start by fitting the rear base of the gateway to the upper part of the rail, pushing downwards (1) to compress the gateway's spring. Then push the gateway against the DIN rail (2) until the base of the gateway box fits onto the rail.

Dismounting the gateway

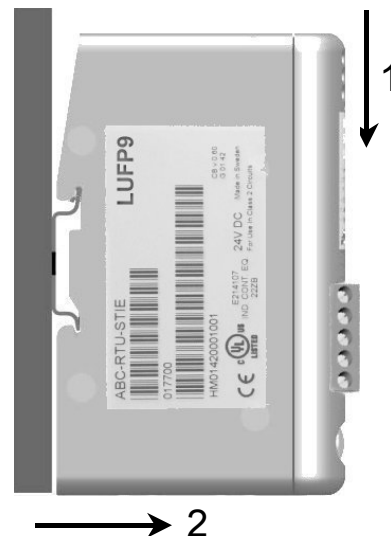

Start by pushing the gateway downwards (1) to compress the gateway's spring. Then pull the bottom of the gateway box forwards (2) until the box comes away from the rail.

NOTE: The spring is also used to ground the gateway (Protective Earth).

2. Hardware Implementation of the LUF9 Gateway

2.4. Powering the Gateway

DeviceNet / Modbus RTU gateway – View from underneath

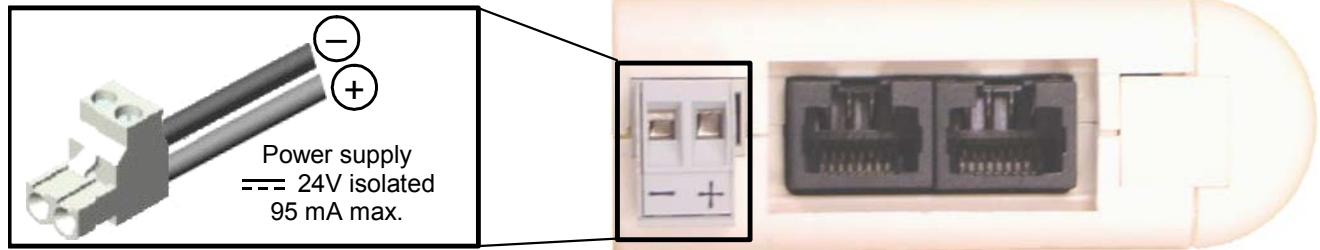

⚠ WARNING

RISK OF UNINTENDED EQUIPMENT OPERATION

Do not use the 24 VDC power available from the DeviceNet network cabling to operate the LUF9 Gateways, as the negative terminal (—) of this power is not necessarily at the installation earth ground potential. Use of an ungrounded power supply may cause the LUF9 devices to operate in an unexpected manner.

To ensure reliable operation, the LUF9 Gateways require a separate power supply where the negative terminal (—) is connected to the installation earth ground.

Failure to follow this instruction may result in death, serious injury, or equipment damage.

2.5. Connecting the Gateway to the Modbus Network

Three typical examples of a Modbus connection for the gateway and its slaves are shown below. There are many other possible Modbus connections, but they are not covered in this document.

2.5.1. Examples of Modbus Connection Topologies

- **“Star” topology:** This topology uses LU9GC03 Modbus hubs, which have 8 female RJ45 connectors. These hubs should be placed close to the Modbus slaves to which they are connected using VW3 A8 306 R•• cables. On the other hand, the nature of the cable connecting the LUF9 gateway to one of these hubs will depend on the network architecture, so long as there is a male RJ45 connector at each end. If necessary, one or two line terminations may be directly connected to the hubs.

2. Hardware Implementation of the LUF9 Gateway

The connections are shown below:

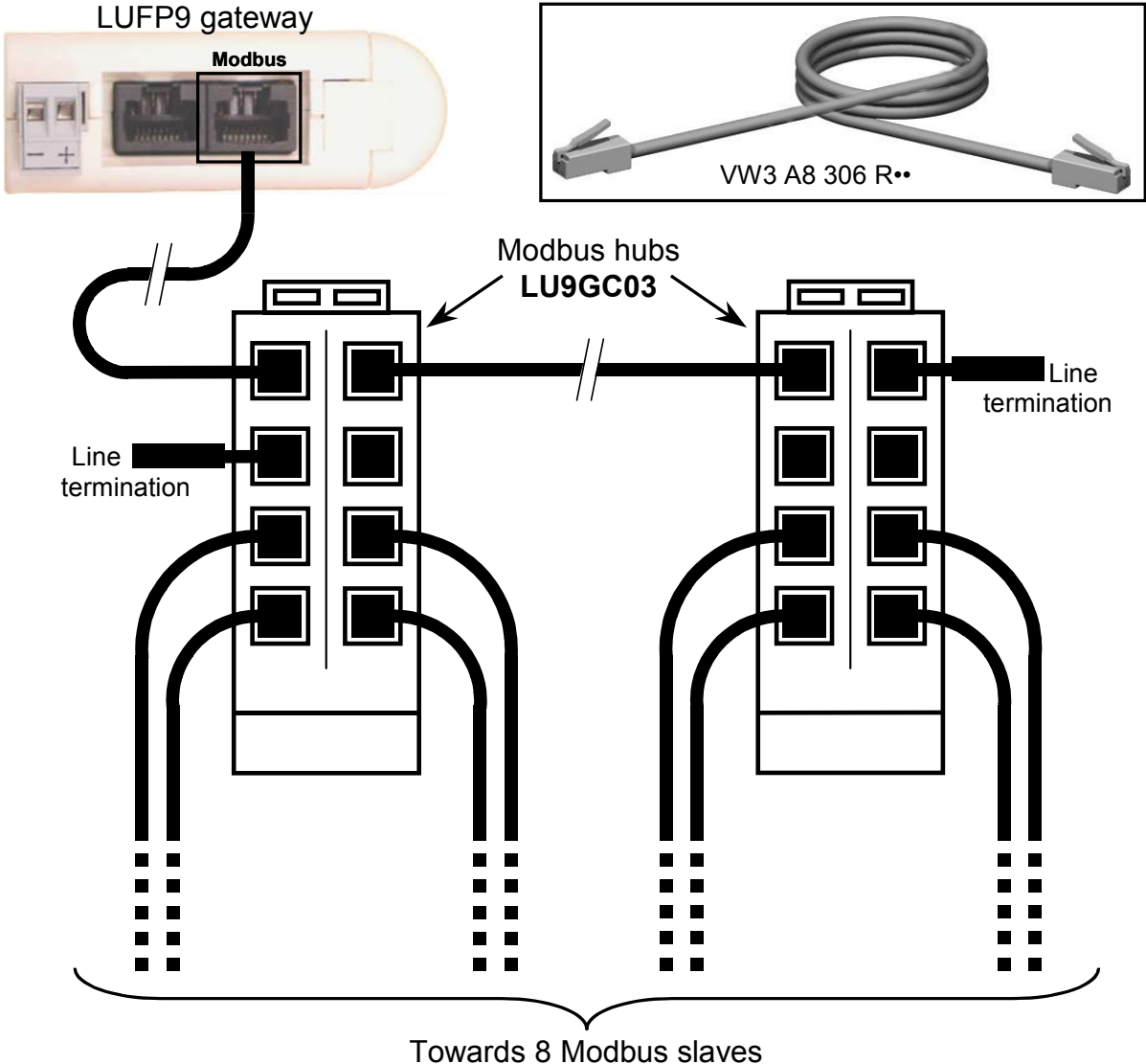

2. Hardware Implementation of the LUF9 Gateway

“Bus” topology with VW3 A8 306 TF3 drop boxes: This topology uses VW3 A8 306 TF3 drop boxes to connect each of the Modbus slaves to the main section of the Modbus network. Each box should be placed in the immediate vicinity of the Modbus slave it is associated with. The cable for the main section of the Modbus network must have male RJ45 connectors (like the VW3 A8 306 R cable used for the “star” topology). The lead between the drop box and the slave or the Modbus gateway is an integral part of this box. The connections are shown below:

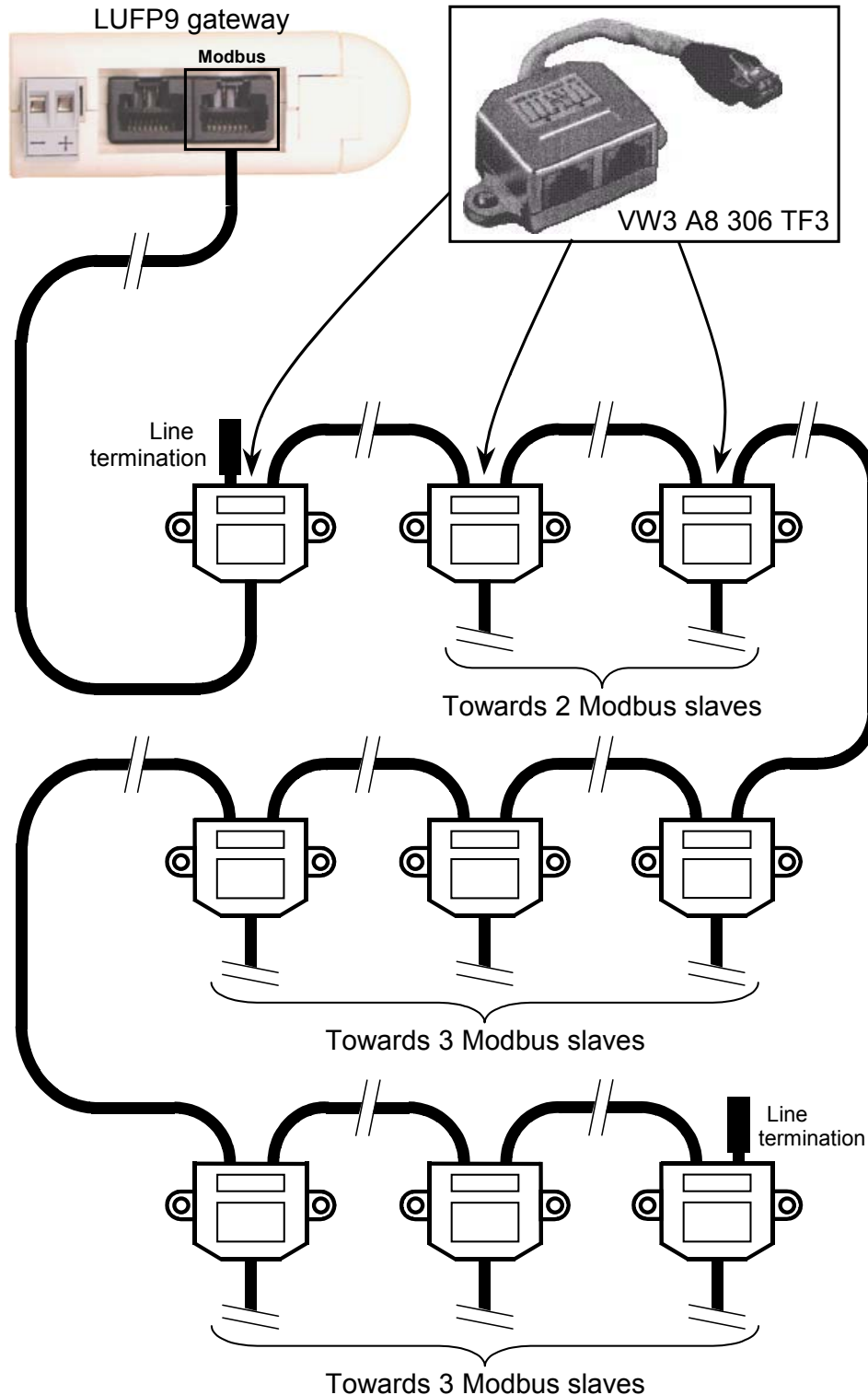

2. Hardware Implementation of the LUF9 Gateway

- **“Bus” topology with tap boxes:** This topology is similar to the previous one, except that it uses TSXSCA62 subscriber connectors and/or TSXCA50 subscriber connectors. We recommend using a VW3 A68 306 connection cable and the TSXCSA•00 Modbus cables. Connect the RJ45 connector on the VW3 A68 306 cable to the Modbus connector on the LUF9 gateway.

The connections are shown below:

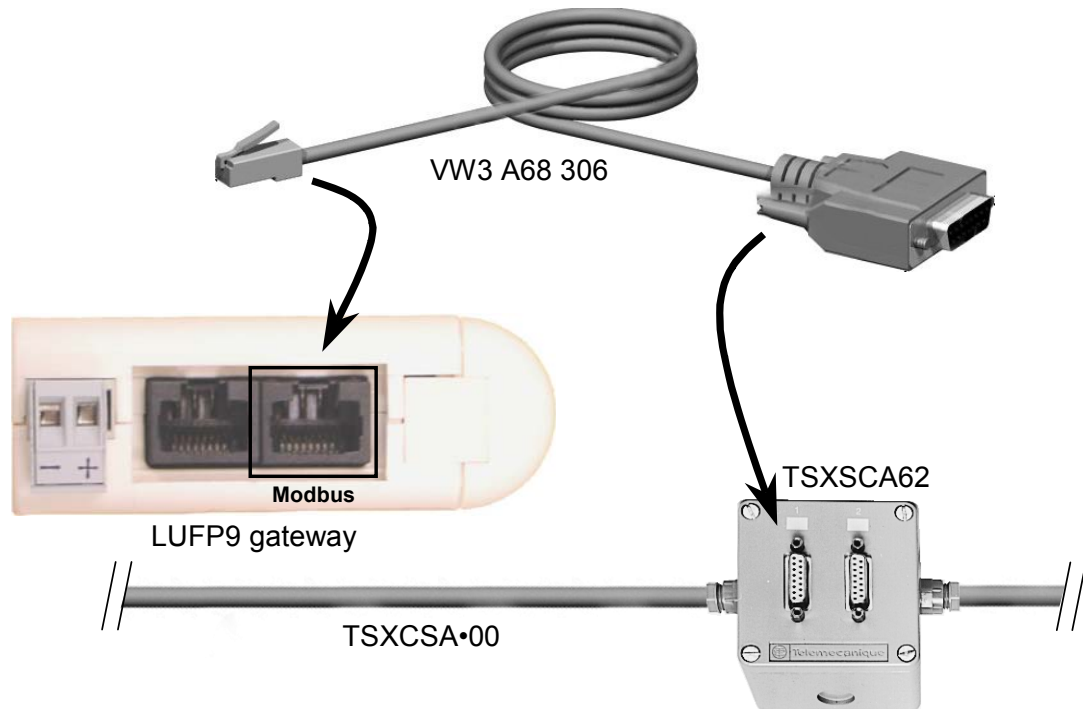

2.5.2. Pin outs

In addition to the pin out for the connector on the gateway, the one on the VW3 A68 306 cable is also shown below, as it is the only Modbus cable which does not exclusively use RJ45 connections.

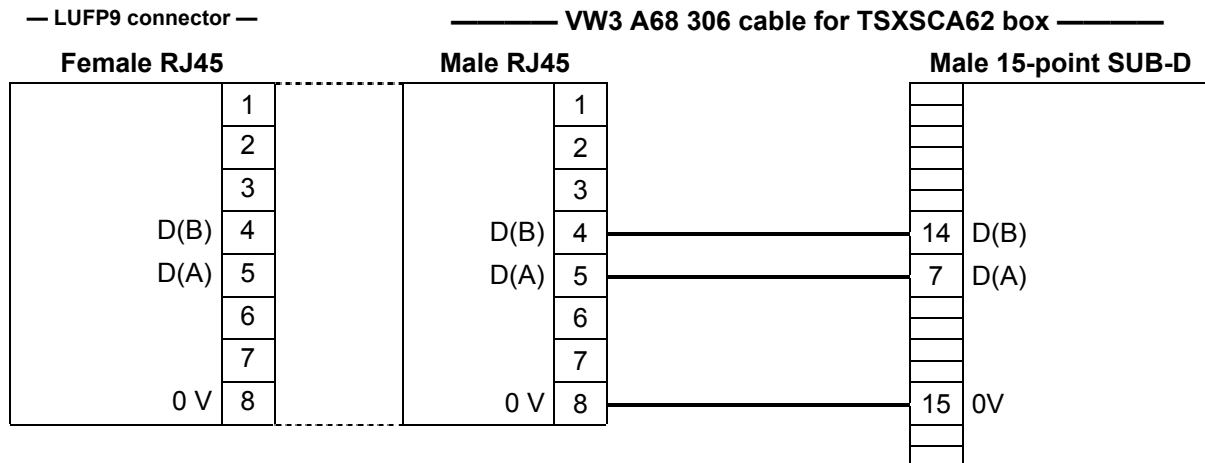

2. Hardware Implementation of the LUF9 Gateway

2.5.3. Wiring Recommendations for the Modbus Network

- Use a shielded cable with 2 pairs of twisted conductors,
- connect the reference potentials to one another,
- maximum length of line: 1,000 meters (3,281 ft)
- maximum length of drop line / tap-off: 20 meters (66 ft)
- do not connect more than 9 stations to a bus (slaves and one LUF9 gateway),

⚠ WARNING

RISK OF UNINTENDED EQUIPMENT OPERATION

Do not connect more than 9 stations to the Modbus fieldbus (gateway and 8 slaves). While the gateway may appear to operate correctly with more than 9 devices, it is likely one or more devices will only communicate intermittently, leading to unpredictable system behavior.

Failure to follow this instruction may result in death, serious injury, or equipment damage.

- cable routing: keep the bus away from power cables (at least 30 cm – 11.8 in.), make crossings at right angles if necessary, and connect the cable shielding to the earth ground on each unit,
- adapt the line at both ends using an RC-type line terminator (see diagram and VW3 A8 306 RC termination below).

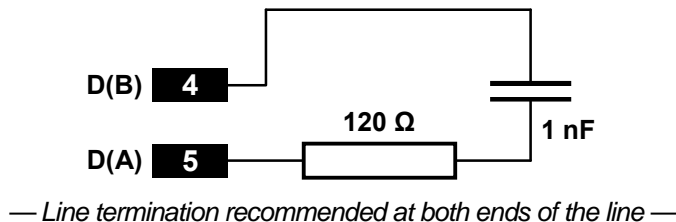

— VW3 A8 306 RC line termination —

⚠ WARNING

MODBUS TERMINATION USING THE RESISTANCE-ONLY METHOD

Use only RC (Resistance-Capacitance) Modbus cable terminations with the LUF9 Gateway. The LUF9 gateways are designed to support client equipment that will not function correctly without using RC-type Modbus cable termination.

Failure to follow this instruction may result in death, serious injury, or equipment damage.

To make it easier to connect the units using the topologies described in chapter 2.5.1 Examples of Modbus Connection Topologies, various accessories are available in the *Schneider Electric* catalogue:

2. Hardware Implementation of the LUF9 Gateway

1) Hubs, drops, taps, and line terminations:

- LU9GC03 hub This passive box has 8 female RJ45 connectors. Each of these connectors can be connected to a Modbus slave, to a Modbus master, to another Modbus hub, or to a line termination.
("star" topology)
 - VW3 A8 306 TF3 drop box..... This passive box includes a short lead with a male RJ45 connector allowing it to be connected directly to a Modbus slave, without having to use a different cable. It is fitted with 2 female RJ45 connectors for the connection of two Modbus cables of the VW3 A8 306 R•• type.
("bus" topology with VW3 A8 306 TF3 drop boxes)
 - 2-way TSXSCA62 subscriber connector. This passive box has a printed circuit fitted with screw terminals and allows the connection of 2 subscribers to the bus (2 female 15 point SUB-D connectors). It includes the line termination when the connector is located at the end. It is fitted with 2 screw terminals for the connection of two double twisted pair Modbus cables.
("bus" topology with branch boxes)
 - TSXCA50 tap box..... This passive box allows a Modbus unit to be connected to a screw terminal. It includes the line termination when the connector is located at the end. It is fitted with 2 screw terminals for the connection of two double twisted pair Modbus cables.
("bus" topology with tap boxes)
 - VW3 A8 306 RC double termination Each of these two red passive boxes is a male RJ45 connector 3 cm (1.2 in.) long containing an RC line termination (see diagram and illustration above). Only the abbreviation "RC" is shown on these boxes.
(all topologies)
-

2) Cables:

- VW3 A8 306 R•• Modbus cable..... Shielded cable with a male RJ45 connector at each end.
("star" topology / "bus" topology with tap boxes)
- VW3 A68 306 Modbus cable..... Shielded cable with a male RJ45 connector and a male 15-point SUB-D connector. It is used to connect a Modbus subscriber (slave or master) to a TSXSCA62 or TSXCA50 box.
("bus" topology with tap boxes)
- Shielded double twisted pair Modbus cable..... Bare cable (without connectors) used to make up the main section of the Modbus network. There are three items available: TSXCSA100 (100 m – 328 ft), TSXCSA200 (200 m – 656 ft), and TSXCSA500 (500 m – 1,640 ft).
("bus" topology with branch boxes)

2. Hardware Implementation of the LUF9 Gateway

2.6. Connecting the LUF9 Gateway to the DeviceNet Network

If the LUF9 gateway is physically located at either end of the DeviceNet network, you will need to connect a line termination to the terminals on its DeviceNet connector.

The resistance of this line termination should be equal to $121\ \Omega$ and it should be connected between pins 2 and 4 on the gateway connector, that is to say between the CAN_L and CAN_H signals.

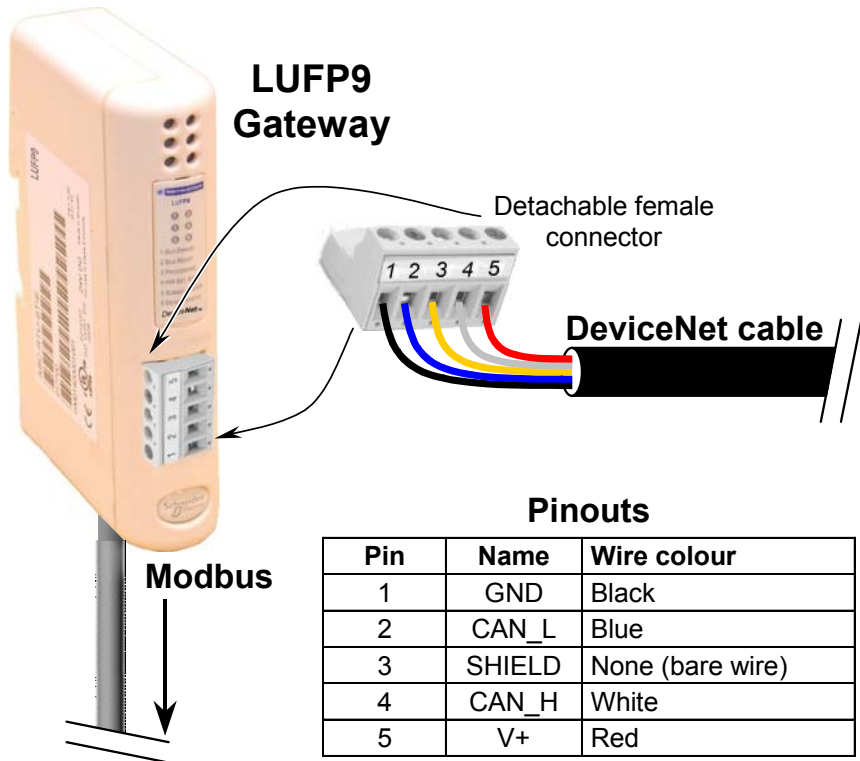

2. Hardware Implementation of the LUF9 Gateway

2.7. Configuring DeviceNet Communication Features

This configuration should be carried out when the gateway is powered off.

⚠ CAUTION

OPENING LUF9 COVER WITH POWER ON

The power supply of the gateway must be turned off before opening the cover. Once the cover has been removed, make sure you touch neither the electrical circuits nor the electronic components, as this may damage the device.

Failure to follow this instruction may result in injury or equipment damage.

The block of selector switches allowing you to configure the DeviceNet communication functions is hidden behind the gateway cover ⑤ (see illustration in chapter 2.2 Introduction to the LUF9 Gateway). To remove this cover, all you have to do is slide the end of a small screwdriver between the top of the cover and the gateway box, then carefully remove it.

The block of selector switches is shown in the diagram below, each switch being shown in its factory set position:

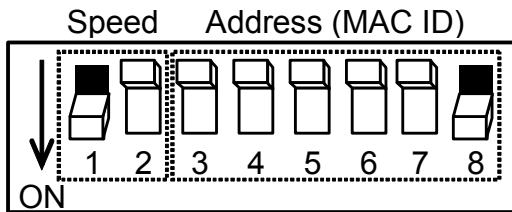

A selector switch is in the 0 state when it is in the OFF position and in the 1 state when it is in the ON position.

Note: Any change to the gateway's communication functions will not be effective until the next time that the gateway is powered on.

2.7.1. Encoding DeviceNet Speed

The gateway's communication speed on the DeviceNet network must be identical to that of the DeviceNet master. If not, a configuration error will result.

The factory setting is 500 kbits/s.

This speed value depends on the position of selector switches 1 and 2.

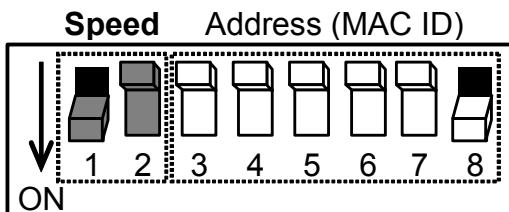

Selector switches 1 2 3 4 5 6 7 8	DeviceNet speed
0 0 x x x x x x	125 kbits/s
0 1 x x x x x x	250 kbits/s
1 0 x x x x x x	500 kbits/s
1 1 x x x x x x	Invalid configuration

2. Hardware Implementation of the LUF9 Gateway

2.7.2. Encoding the Gateway Address

The LUF9 gateway is identified on the DeviceNet bus by its address (or “MAC ID”), which is between 0 and 63.

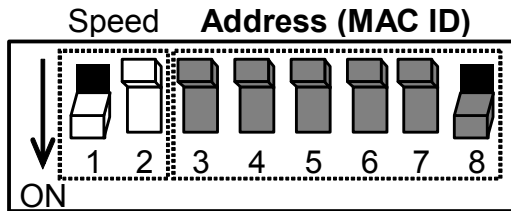

The gateway's DeviceNet address depends on the position of selector switches 3 to 8. It corresponds to the binary number given by the ON (1) or OFF (0) position of these 6 selector switches.

Selector switches 1 2 3 4 5 6 7 8	DeviceNet address
xx000000	0
xx000001	1
xx000010	2
xx000011	3
xx000100	4
xx000101	5
xx000110	6
xx000111	7
xx001000	8
xx001001	9
xx001010	10
xx001011	11
xx001100	12
xx001101	13
xx001110	14
xx001111	15
xx010000	16
xx010001	17
xx010010	18
xx010011	19
xx010100	20
xx010101	21

Selector switches 1 2 3 4 5 6 7 8	DeviceNet address
xx010110	22
xx010111	23
xx011000	24
xx011001	25
xx011010	26
xx011011	27
xx011100	28
xx011101	29
xx011110	30
xx011111	31
xx100000	32
xx100001	33
xx100010	34
xx100011	35
xx100100	36
xx100101	37
xx100110	38
xx100111	39
xx101000	40
xx101001	41
xx101010	42
xx101011	43

Selector switches 1 2 3 4 5 6 7 8	DeviceNet address
xx101100	44
xx101101	45
xx101110	46
xx101111	47
xx110000	48
xx110001	49
xx110010	50
xx110011	51
xx110100	52
xx110101	53
xx110110	54
xx110111	55
xx111000	56
xx111001	57
xx111010	58
xx111011	59
xx111100	60
xx111101	61
xx111110	62
xx111111	63

2. Hardware Implementation of the LUF9 Gateway

2.7.3. Sample Gateway Configurations

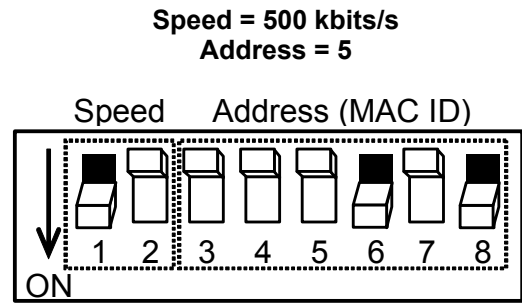
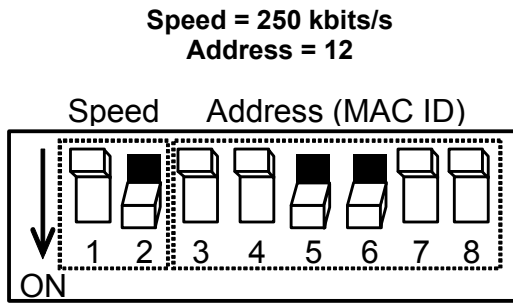

3. Signaling

The gateway's 6 LEDs and the descriptive label on the removable cover allow you to diagnose the status of the gateway:

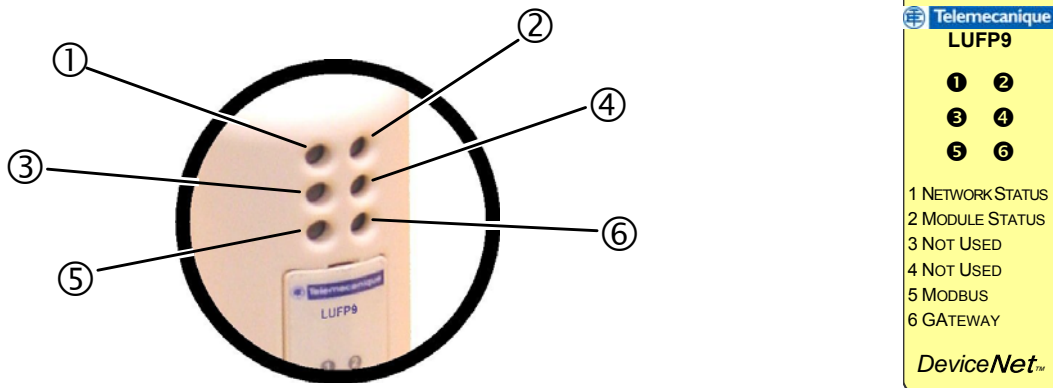

LED	LED → Gateway state
1 NETWORK STATUS	Off: Gateway not connected to the DeviceNet bus
	Green: Gateway connected to the DeviceNet bus: Connection established
	Red: Fatal error on connection to the DeviceNet bus
	Flashing (green): Gateway connected to the DeviceNet bus: Connection not established
	Flashing (red): Timeout in connection to the DeviceNet bus ↳ <i>The length of this timeout is defined by the DeviceNet master</i>
3 NOT USED	Off: —
5 MODBUS	Off: No power
	Flashing (green): No Modbus communications
	Green: Modbus communications OK
	Red: <ul style="list-style-type: none"> - Loss of communication with at least one Modbus slave (no answer from the slave) (1) - Exception code coming from a command or a transaction

LED	LED → Gateway state
2 MODULE STATUS	Off: No power
	Red: Unrecoverable failure
	Green: Gateway is operational
	Flashing (red): Fault
4 NOT USED	Off: —
6 GATEWAY	Off: No power
	Flashing (red/green): Configuration absent / not valid ↳ <i>Use ABC-LUFP Config Tool to load a valid configuration</i>
	Green: Gateway currently being initialized and configured
	Flashing (green): Gateway is in running order: Configuration OK

3. Signaling

- (1) The MODBUS LED ⑤ becomes red when one or more Modbus slaves fail to respond to the gateway in the expected fashion. This can be caused by:
- Loss of communications (e.g. a broken or disconnected cable)
 - Writing incorrect values to the outputs corresponding to the two aperiodic read/write services (see chapter 4.3, Description of Services Assigned to Gateway I/O).

Note: When MODBUS LED ⑤ is flashing red due to a simple loss of communications, the LED will revert to a green state when communications are restored. When LED (5) is flashing red due to the use of incorrect values with the aperiodic read/write services, then the only way to clear the error is to reuse these aperiodic services with correct values.

Note: If the DEVICENET STATUS LED ⑥ is flashing following a sequence beginning with one or more red flashes, we advise that you note down the order of this sequence and give this information to the Schneider Electric support service. In some cases, all you need to do is power the gateway off then back on again to solve the problem.

4. Software Implementation of the Gateway

4.1. Introduction

This chapter gives an introduction to a quick implementation of the LUF9 gateway, using its default configuration. All LUF9 gateways ship pre-configured.

NOTE: The configuration has been defined for 8 motor starters. If you use less than 8, refer to chapter 6 Configuring the Gateway.

The default configuration provided by Schneider Electric is intended to provide a good starting point for customers using TeSys U motor starters and to minimize the configuration changes required for most installations. The default configuration allows the gateway to be used with a configuration tool for DeviceNet Master PLCs. However, it is the sole responsibility of the user to ensure the default configuration, or any other configuration, is safe and appropriate for their facility and intended use;

4.1.1. System Architecture

The default configuration for an LUF9 gateway allows it to control, monitor and configure 8 TeSys U motor starters:

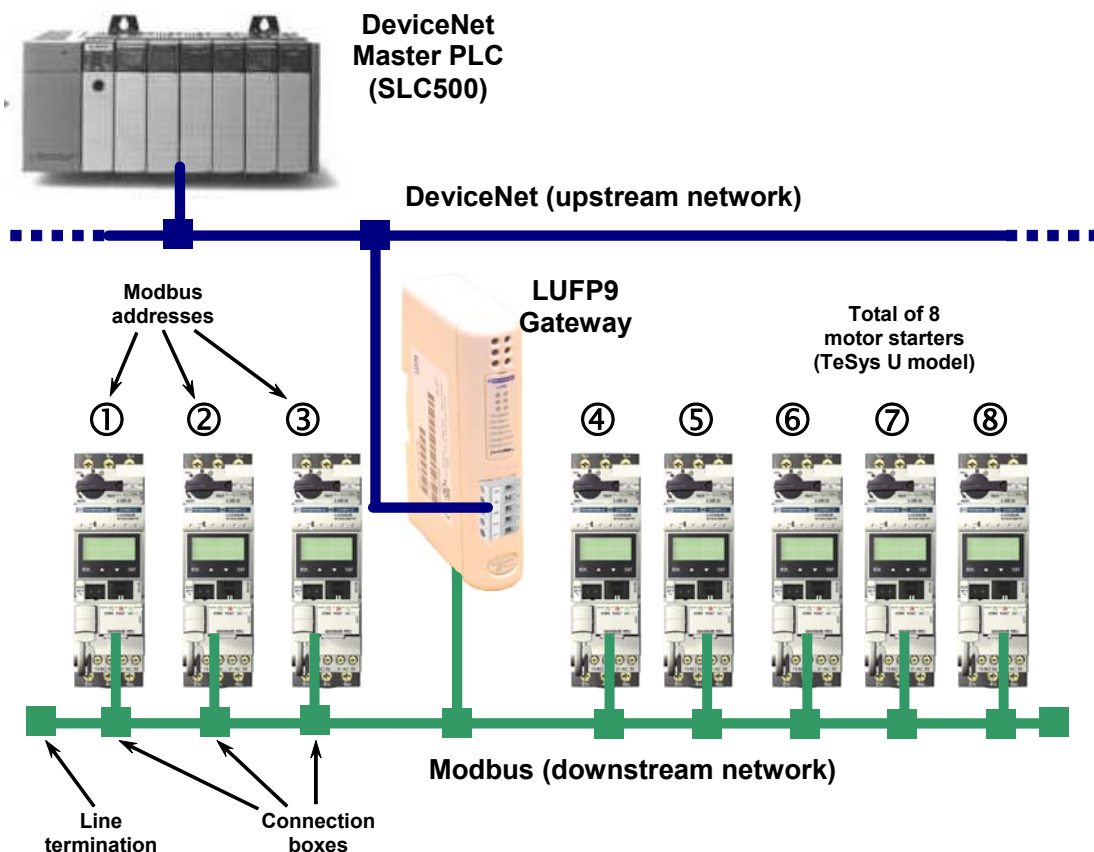

Please see chapter 2 Hardware Implementation of the LUF9 Gateway, for the hardware implementation of the default configuration.

4. Software Implementation of the Gateway

4.1.2. Configuring the Motor Starters

Each motor starter should be configured as follows:

Protocol:	Modbus RTU slave	Start bits	1
Modbus address	1 to 8	Parity	None
Bitrate	19,200 bits/s	Parity bit	0
Data bits	8	Stop bits	1

When using a TeSys U motor starter with a Modbus communication module (LULC03*), the configuration parameters for the RS485 connection are automatically detected, only the Modbus address needs to be configured.

4.1.3. Modbus Cycle Time

The LUF9 gateway's default configuration sets a cycle time of 300 ms on Modbus commands. This cycle time corresponds to the polling time necessary to cover all of the 8 motor starters.

4.1.4. Managing Degraded Modes With the Gateway Default Configuration

The degraded modes with the gateway default configuration is described below, but it takes no account of the PLC used or of the DeviceNet scanner. Please see chapter 6.11.2.1 Managing Degraded Modes, if you would like to manage the degraded modes for any other configuration.

4.1.4.1. Description of the Gateway Degraded Mode Options

Offline options for fieldbus

This option affects the data sent to a Modbus slave if there is no communication coming from the DeviceNet master.

It is defined at the Query level of each command or transaction sent to the different slaves.

This option can take 3 values:

- Clear : All data sent to the concerned Modbus slave is set to 0.
- Freeze : All data sent retains its current value.
- No scanning : The query is no more transmitted.

With the gateway's default configuration:

- "Clear" option is selected for periodic exchanges
- "No scanning" is selected for aperiodic exchanges

Which means that Tesys Command and Status registers continue to be refreshed :
but output memory associated (Tesys U command registers) is forced to 0,
and input memory (Tesys U status registers) works normally,
Aperiodic Modbus exchanges are stopped.

Timeout time

This option defines the time the gateway will wait for a response before it either retries to send the same request, or it disconnects the slave and declares it missing.

It is defined at the Query level of each command or transaction sent to the different slaves.

With the gateway's default configuration, this time is equal to 300 ms.

4. Software Implementation of the Gateway

Retries

This option determines the number of re-transmissions carried out by the gateway if there is no response from the slave.

It is defined at the Query level of each command or transaction sent to the different slaves.

With the gateway's default configuration, this option is set to 3.

Reconnect time

This option defines the time the gateway will wait for a response before it reconnects a slave that was missing.

It is defined at the Query level of each command or transaction sent to the different slaves.

With the gateway's default configuration, this time is equal to 10 sec.

WARNING

RISK OF UNINTENDED EQUIPMENT OPERATION

During the reconnect time, you cannot control a slave (read/write) via the bus. Depending on the slave characteristics and the watchdog configuration, the slave can keep the same status or take a fallback position.

To avoid an unintended equipment operation, you must know the possible status of a slave and adapt the timeout and reconnect time values according to the request sending rate.

Failure to follow this instruction may result in death, serious injury, or equipment damage.

Offline options for sub-network

This option affects the data sent to the DeviceNet scanner if there is no response coming from a slave.

It is defined at the Response level of each command or transaction sent from the different slaves.

This option can take 2 values:

Clear : All data sent to the DeviceNet scanner is set to 0.

Freeze : All data sent to the DeviceNet scanner retains its current value.

With the gateway's default configuration, "Clear" option is selected and Tesys U status registers and aperiodic input data are forced to 0.

4.1.4.2. Degraded Mode Description

This description takes into account the following elements:

The PLC processor

The DeviceNet scanner

The LUFP9 gateway

The Tesys U starters-controllers.

4. Software Implementation of the Gateway

PLC processor stopped or on failure

PLC processor response
Outputs: Software error, outputs reset to default state or hold their present state depending on configuration. Hardware error (EEPROM or hardware failure), output state will be indeterminate.
Inputs: PLC stops responding to inputs in any error state.
DeviceNet scanner response
Depending on scanner configuration: the scanner stops communicating with the LUFP9 gateway, or forces DeviceNet outputs to 0, and refreshes the inputs, or holds DeviceNet outputs in their last position, and refreshes inputs.
LUFP9 gateway response
If the scanner stops to communicate with the gateway: periodic Modbus exchanges continue to run with output memory associated forced to 0, input memory continues to be refreshed, aperiodic Modbus exchanges are stopped.
If the scanner forces DeviceNet outputs to 0, and refreshes the inputs: periodic Modbus exchanges continue to run with outputs set to 0, input memory continues to be refreshed, aperiodic Modbus exchanges are stopped.
If the scanner holds DeviceNet outputs, and refreshes the inputs: periodic Modbus exchanges continue to run, with output memory associated held in their last position, input memory continues to be refreshed, aperiodic Modbus exchanges are stopped.
Tesys U response
If the scanner stops to communicate or forces the outputs to 0: periodic Modbus exchanges continue to run, Command registers are set to 0 and motors are stopped, Status register are transmitted to the gateway, aperiodic Modbus exchanges are stopped.
If the scanner holds DeviceNet output words, and refreshes the inputs words: periodic Modbus exchanges continues to run, Command registers hold their last values and motors stays in the same state, Status register data is transmitted to the gateway, aperiodic Modbus exchanges are stopped.

4. Software Implementation of the Gateway

DeviceNet scanner stopped or on failure

PLC processor response
The PLC processor provides some error and/or diagnostic objects to the application in case of DeviceNet scanner stop or failure (input/output not valid). Refer to the PLC user manual to have their description. This information must be managed in the PLC application.
DeviceNet scanner response
If the DeviceNet scanner is stopped (command coming from the application): the scanner stops to communicate with the LUF9 gateway.
If the DeviceNet scanner is on failure, the scanner stops to communicate with the processor and the LUF9 gateway.
LUF9 gateway response
With the gateway default configuration (Offline option for fieldbus): Periodic Modbus exchanges continue to run, with the output memory associated forced to 0, input memory continues to be refreshed, aperiodic Modbus exchanges are stopped.
Tesys U response
Periodic Modbus exchanges continue to run: Command registers are set to 0 and motors are stopped, Status register data is transmitted to the gateway, aperiodic Modbus exchanges are stopped.

LUF9 gateways disconnected on DeviceNet side

PLC response
The PLC processor provides some error and diagnostic objects coming from the DeviceNet scanner in case of slave disconnection from the application: Refer to the PLC user manual to have their description. This information must be managed in the PLC application.
DeviceNet scanner response
The DeviceNet scanner provides the processor with some error and diagnostic objects in case of DeviceNet slave disconnection.
LUF9 gateway response
With the gateway default configuration (Offline option for fieldbus): Periodic Modbus exchanges continue to run, with output memory associated forced to 0, input memory continues to be refreshed, aperiodic Modbus exchanges are stopped.
Tesys U response
Periodic Modbus exchanges continue to run: Command registers are set to 0 and motors are stopped, Status register data is transmitted to the gateway, aperiodic Modbus exchanges are stopped.

4. Software Implementation of the Gateway

LUFP9 gateways failure

PLC response
The PLC processor provides some error and diagnostic objects coming from the DeviceNet scanner in case of slave failure to the application. Refer to the PLC user manual to have their description. This information must be managed in the PLC application
DeviceNet scanner response
The DeviceNet scanner provides the processor with some error and diagnostic objects in case of DeviceNet slave failure.
LUFP9 gateway response
In case of a failure, the gateway stops to communicate with the DeviceNet scanner and the Modbus slaves.
Tesys U response
Depending on the Tesys U configuration: If the starters-controllers do not receive any requests, they will: stop the motor, keep the same state, or run the motor. Refer to the Tesys U user manuals to adjust these fallback positions.

LUFP9 gateways disconnected on Modbus side or Tesys U failure

PLC response
The processor gives access to the gateway status word coming from the DeviceNet scanner input table and to the gateway command word coming from the output table. These 2 words must be managed in the PLC application in order to detect if a Modbus slave is missing.
DeviceNet scanner response
The DeviceNet scanner must be configured to access the gateway status and command words in order to provide Modbus diagnostic information.
LUFP9 gateway response
With the gateway's default configuration: Timeout time = 300 ms, Retries = 3, Reconnect time = 10 sec, and Offline option for sub-network = Clear. After sending a request to a slave, if there is no response after 300 ms, the gateway will send it again twice before giving the information about the slave missing in the gateway status word. Data sent to the DeviceNet scanner (Read requests) is set to 0. The gateway will try to reconnect the slave missing with the same sequence every 10 seconds.
Tesys U response
If the LUFP9 gateway is disconnected on Modbus side: The starters-controllers do not receive any requests, depending on their configuration they will: stop the motor, keep the same state, or run the motor. Refer to the Tesys U user manuals to adjust the fallback position.
In case of a Tesys U failure: No response is sent to the gateway, the motor state will be undetermined. This case must be managed in the PLC application.

4. Software Implementation of the Gateway

4.2. Configuring the Gateway in RSNetWorx

The DeviceNet master PLC must be configured so that it has access to all of the data described in Appendix B: Default Configuration, Input and Output data Memory.

The following chapters describe the steps in RSNetWorx which you will need to go through so that the gateway is correctly recognised by the DeviceNet master PLC.

NOTE: The DeviceNet network which is described in the following chapters only includes one master and one slave (LUFP9 gateway). So you will need to adapt the addressing of the inputs and outputs shown below (%IW and %QW) according to any other slaves on the DeviceNet network which you need to configure.

4.2.1. Selecting and Adding the Master PLC's DeviceNet Scanner

In RSNetWorx, select the type of scanner you have and add it to the DeviceNet network topology.

In our example, this scanner is a “1747-SDN Scanner Module (4)” and its MAC ID address is set to 00.

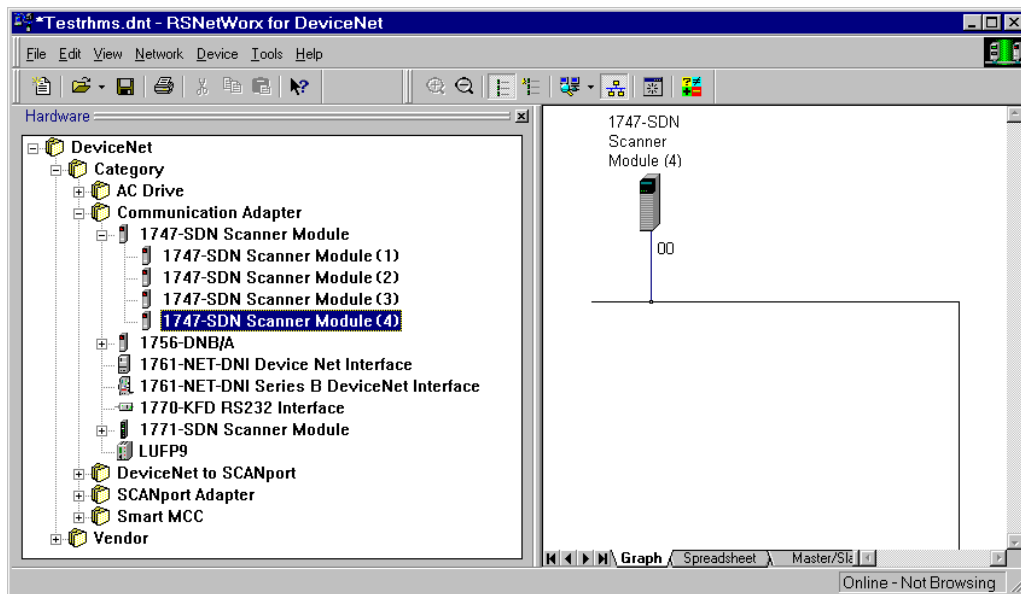

4.2.2. Installing the Gateway Description File

The EDS file describing the gateway must be placed on the PC's hard disk so that RSNetWorx has access to it at all times.

This file can be found on the CD LU9CD1: “LUFP9_100.eds”.

→ Once you are inside RSNetWorx, see the documentation to read how to import an EDS file. This procedure should then be applied to the file “LUFP9_100.eds”. It uses the “EDS wizard”, which is accessible from the “Tools” menu.

The following two entries are then added to the tree structure for recognised DeviceNet products:

- DeviceNet / Category / Communication Adapter / LUFP9
- DeviceNet / Vendor / Schneider Automation / LUFP9

4. Software Implementation of the Gateway

4.2.3. Selecting and Adding a Gateway to the DeviceNet Network

Select "LUFP9" from the list on the left, then add it to the DeviceNet network topology.

In our example, we have assigned the MAC ID address 04 to the gateway (the configuration of the address for a gateway is described in chapter 2.7.2 Encoding the Gateway Address).

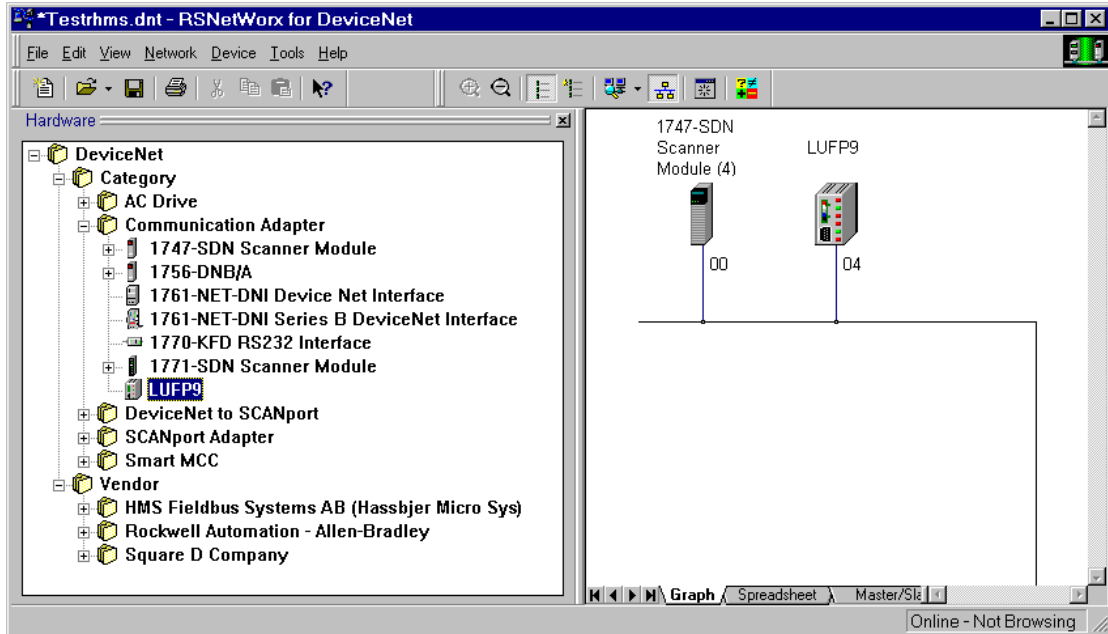

4.2.4. Editing Gateway Parameters

Double-click on the icon which corresponds to the gateway, in the frame on the right.

In the window which then appears, select the "Device Parameters" tab and check that the values for the parameters correspond to those for the parameters shown below. If necessary, change them (only parameters 1 to 5 are accessible to the user in write mode), then click on the "Download To Device" button to send these changes to the gateway.

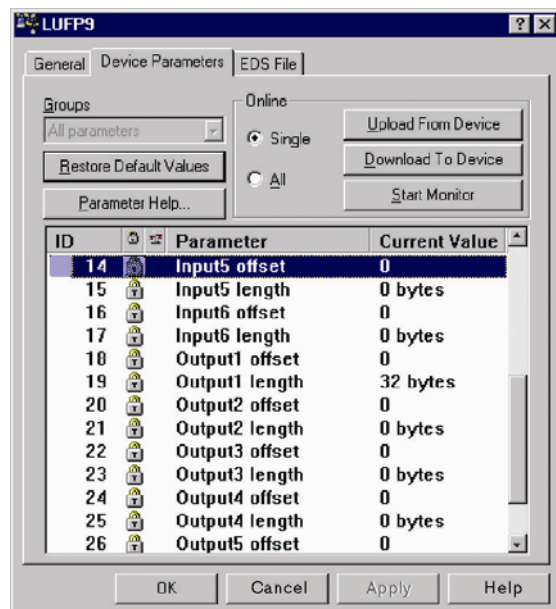
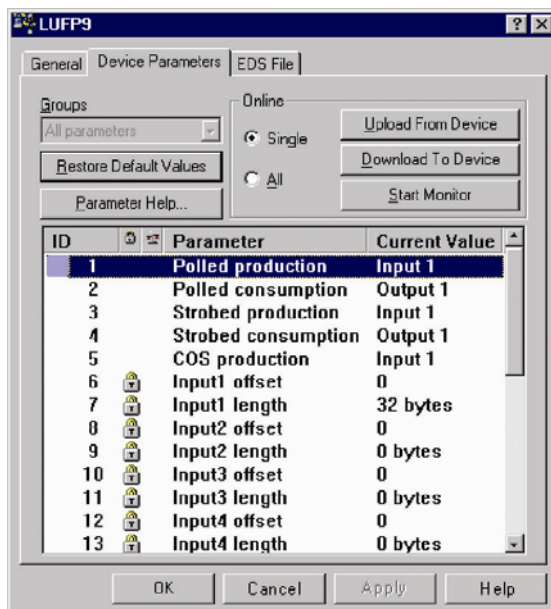

4. Software Implementation of the Gateway

If you are in any doubt over what is displayed, click on the “Upload From Device” button, then on “Start Monitor”. The RSNetWorx application then starts to read from the gateway the values of the parameters currently displayed. Click on the “Stop Monitor” button to stop this reading process.

The most important parameters, in the case of the default gateway configuration, are parameters 1 and 2 (periodic transfers between the PLC and the gateway via a periodic connection known as “polled”), 6 and 7 (offset and size of the input data area in the gateway’s input memory), and 18 and 19 (offset and size of the output data area in the gateway’s output memory). The value of each “offset” type parameter refers to an offset from the start of the gateway’s input data memory area.

NOTE: Only monitoring of the “Input1” and “Output1” areas is discussed in this manual. The monitoring of Input2 to Input6, and Output2 to Output6 is an advanced application and is outside the scope of this manual. Contact *Schneider Electric* support for assistance in monitoring the parameters.

NOTE: If you create or change a configuration using the ABC-LUFP Config Tool (see chapter 6), confirm that the I/O data areas defined in the gateway’s memory are appropriate for the new configuration, and for communications with the DeviceNet master. These I/O data areas define all of the bytes exchanged with the Modbus slaves via the “Data” or “Preset Data” fields in the Modbus frames. If you do not take these steps, a configuration error may result.

4. Software Implementation of the Gateway

4.2.5. Configuring the DeviceNet Scanner

Double-click on the icon which corresponds to the DeviceNet scanner.

A window then appears allowing you to configure the exchanges carried out by the scanner. Select the “Scanlist” tab and add the “LUF9” gateway to the “Scanlist” (or buttons). After selecting the gateway from this list, the “Edit I/O Parameters...” button becomes accessible.

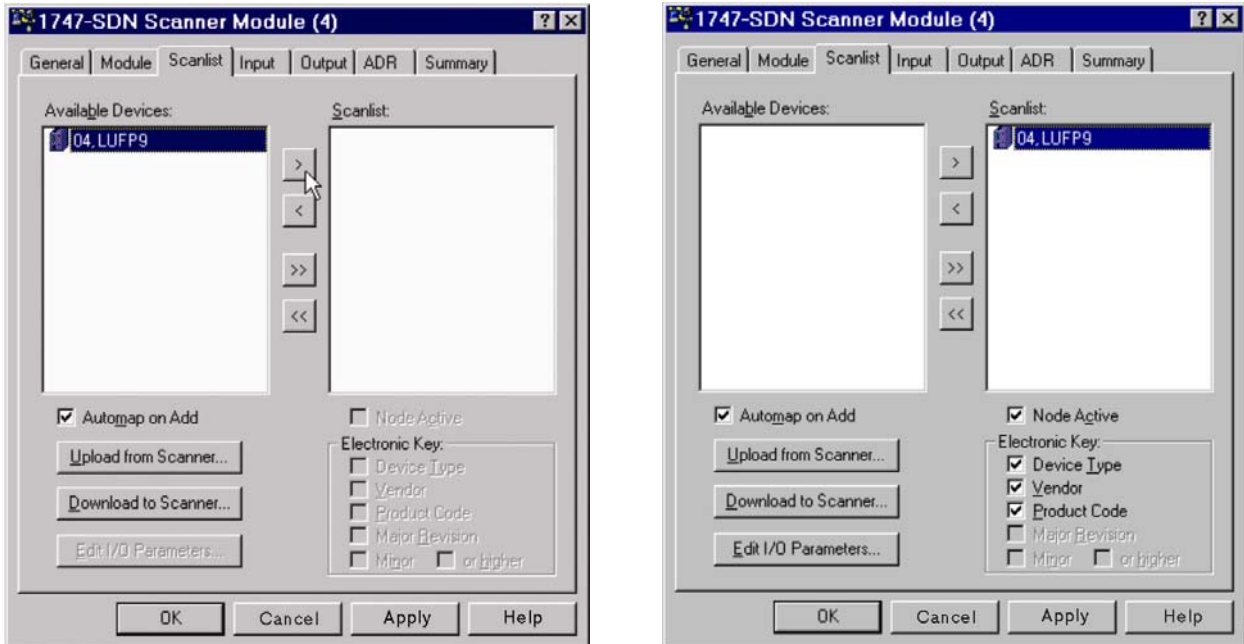

Click on the “Edit I/O Parameters...” button.

In the window that appears, check the “Polled:” box, then configure the size of the data received (Rx = 32 bytes) and the size of the data transmitted (Tx = 32 bytes) by the scanner.

With the LUF9 gateway’s default configuration, these values allow you to exchange all of the data shown in Appendix B: Default Configuration.

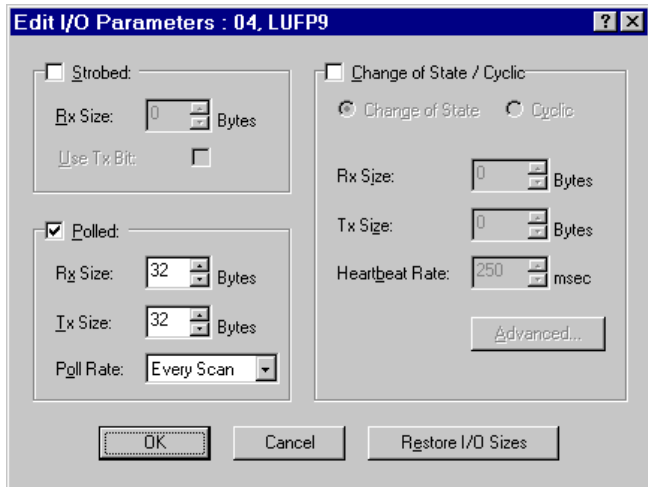

NOTE: If you create or change a configuration using ABC-LUF9 Config Tool, see chapter 6 Configuring the Gateway.

4. Software Implementation of the Gateway

4.2.6. Configuring Inputs from the Gateway

On the “Input” tab, select the “LUFF9” gateway, then click on the “AutoMap” button. RSNetWorx then automatically establishes the correspondence between the 32 data bytes (8-bit format) from the gateway and the corresponding 16 PLC inputs “I:1.1” to “I:1.16” (16-bit format).

Please check that a correspondence between all of the data from the gateway and the PLC inputs “I:1.1” to “I:1.16” has been established.

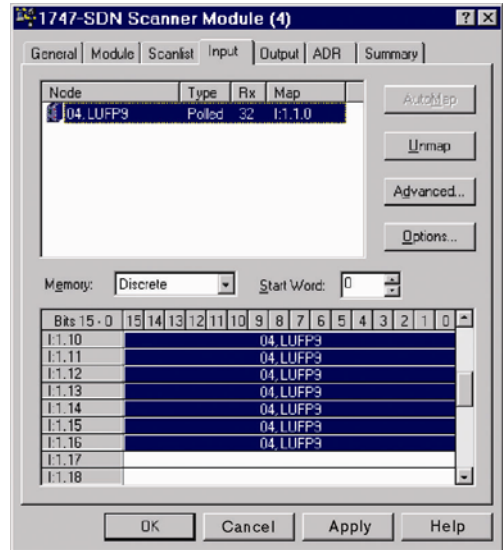
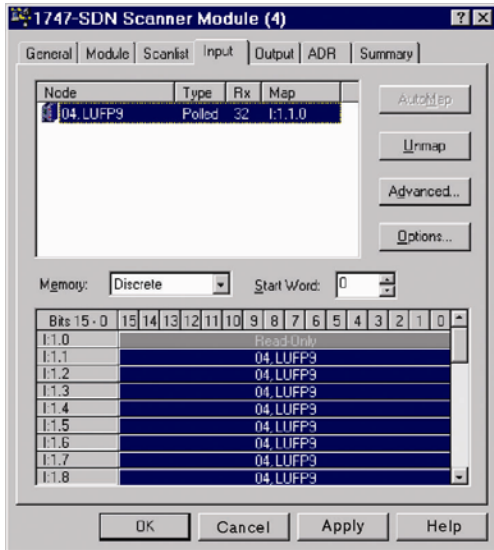

The correspondence between the contents of the gateway’s input memory (see Appendix B: Default Configuration) and PLC inputs “I:1.1” to “I:1.16” is given in the following table:

Service	PLC input	Description	
		Bit 0.....Bit 7	Bit 8Bit 15
Managing the downstream Modbus network (Status Word)	I:1.1	LUFF9 gateway status word (MSB → 0xxx••)	(LSB → 0x••xx)
Periodic communications — Monitoring of TeSys U motor starters	I:1.2	Value of the motor starter ① status register	
	I:1.3	Value of the motor starter ② status register	
	I:1.4	Value of the motor starter ③ status register	
	I:1.5	Value of the motor starter ④ status register	
	I:1.6	Value of the motor starter ⑤ status register	
	I:1.7	Value of the motor starter ⑥ status register	
	I:1.8	Value of the motor starter ⑦ status register	
Aperiodic communications — Reading the value of a motor starter parameter (RESPONSE)	I:1.9	Value of the motor starter ⑧ status register	
	I:1.10	Memory location free	Slave no. (0x01-0x08)
	I:1.11	Function number (0x03)	Number of bytes read (0x02)
Aperiodic communications — Writing the value of a motor starter parameter (RESPONSE)	I:1.12	Value of the parameter read (MSB → 0xxx••) (LSB → 0x••xx)	
	I:1.13	Slave no. (0x01-0x08)	Function no. (0x06)
	I:1.14	Address of the parameter written (MSB → 0xxx••) (LSB → 0x••xx)	
Aperiodic communications (“Trigger bytes” for the responses)	I:1.15	Value of the parameter written (MSB → 0xxx••) (LSB → 0x••xx)	
	I:1.16	Read parameter response counter	Write parameter response counter

4. Software Implementation of the Gateway

4.2.7. Configuring Outputs Intended for the Gateway

On the “Output” tab, select the “LUFP9” gateway, then click on the “AutoMap” button. RSNetWorx then automatically establishes the correspondence between the 32 data bytes (8-bit format) to be sent to the gateway and the corresponding 16 PLC outputs “O:1.1” to “O:1.16” (16-bit format).

Please check that a correspondence between all of the data sent to the gateway and the PLC outputs “O:1.1” to “O:1.16” has been established.

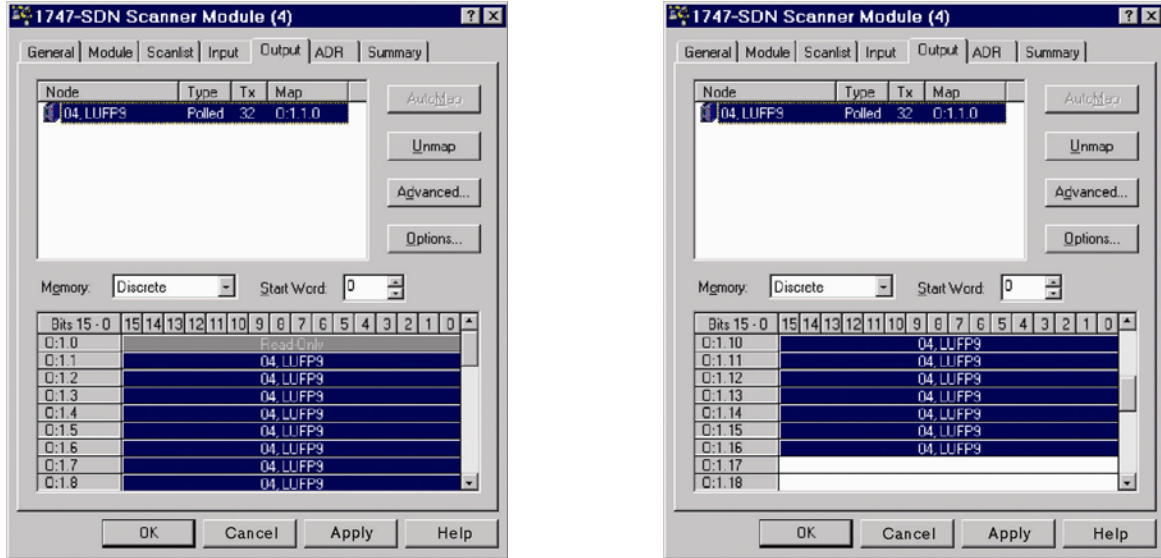

The correspondence between the contents of the gateway’s output memory (see Appendix B: Default Configuration, Output Data Memory Area and PLC outputs “O:1.1” to “O:1.16”) is given in the following table:

Service	PLC output	Description	
		Bit 0 Bit 7	Bit 8 Bit 15
Managing the downstream Modbus network (Command Word)	O:1.1	DeviceNet master command word (MSB → 0xxx••)	(LSB → 0x••xx)
Periodic communications — Controlling TeSys U motor starters	O:1.2	Value of the motor starter ① command register	
	O:1.3	Value of the motor starter ② command register	
	O:1.4	Value of the motor starter ③ command register	
	O:1.5	Value of the motor starter ④ command register	
	O:1.6	Value of the motor starter ⑤ command register	
	O:1.7	Value of the motor starter ⑥ command register	
	O:1.8	Value of the motor starter ⑦ command register	
Aperiodic communications — Reading the value of a motor starter parameter (QUERY)	O:1.9	Value of the motor starter ⑧ command register	
	O:1.10	Slave no. (0x01-0x08)	Function no. (0x03)
	O:1.11	Address of the parameter to be read (MSB → 0xxx••) (LSB → 0x••xx)	
Aperiodic communications — Writing the value of a motor starter parameter (QUERY)	O:1.12	Number of parameters to be read (MSB → 0x00••) (LSB → 0x••01)	
	O:1.13	Slave no. (0x01-0x08)	Function no. (0x06)
	O:1.14	Address of the parameter to be written (MSB → 0xxx••) (LSB → 0x••xx)	
Aperiodic communications (“Trigger bytes” for the queries)	O:1.15	Value of the parameter to be written (MSB → 0xxx••) (LSB → 0x••xx)	
	O:1.16	Read parameter query counter	Write parameter query counter

4. Software Implementation of the Gateway

4.2.8. Transferring the DeviceNet Scanner Configuration

Once you have finished the operations described above, make sure that the changes made have been transmitted to the DeviceNet scanner. To do this, click on the “Download to Scanner...” button on each of the “Module” and “Scanlist” tabs in the DeviceNet scanner properties window.

If necessary, please see the RSNNetWorx documentation for further details on this subject.

4.2.9. Developing a DeviceNet Application

The DeviceNet master PLC used as an example is an SLC500, marketed by *Allen Bradley*. An example of a PLC application, developed in RSLogix 500, is shown in Appendix C: Practical Example (RSLogix 500). This example uses the PLC, the gateway and the 8 TeSys U motor starters shown in the Software Implementation of the Gateway.

4.3. Description of Services Assigned to Gateway I/O

Managing the downstream Modbus network: Please see chapter 5.25, Diagnostic Only, for a detailed description of this service. The example described in Appendix C: Main Program, only automatically acknowledges gateway diagnostics, that is to say it does not exploit the data from these diagnostics. In the case of the gateway’s default configuration, under ABC-LUFP Config Tool, the “Control/Status Byte” field of the “ABC” element is equal to “Enabled but no startup lock.”

Periodic communications (inputs): The value of each of the 8 words for this service corresponds to the value of the status register of a TeSys U motor starter (register located at address 455).

Periodic communications (outputs): The value of each of the 8 words for this service corresponds to the value to be sent to the command register for a TeSys U motor starter (register located at address 704).

Please see Appendix C: Controlling/Monitoring Sub-Program, for an example of the simplified use of these “periodic communications” services.

Aperiodic communications: Please see Appendix C: Sub-Program for Reading a Parameter... and Sub-Program for Writing a Parameter..., for an example of how to use the “aperiodic communications” services.

These aperiodic communications services offer functions similar to those of “parameter area PKW”, which can be found on certain *Schneider Electric* products, such as some ATV drives.

When using 16-bit inputs and outputs for which the order of the LSB and MSB is specified, the DeviceNet master uses Big Endian byte ordering (LSB MSB), while the Modbus slaves use Little Endian (MSB LSB). In many situations, the DeviceNet master will handle this conversion internally, but this may not be the case with certain configurations, aperiodic services, or with custom applications. It is necessary this behaviour be properly characterized before placing the system into service.

WARNING

RISK OF UNINTENDED EQUIPMENT OPERATION

The user must ensure the conversion of Endian (byte order within a 16-bit word) is correct between the DeviceNet and Modbus fieldbuses. During configuration of the DeviceNet master, or when utilizing custom applications or programming to communicate between the DeviceNet master and the Modbus slaves via the gateway, the handling of Endian (byte order within a 16-bit word) must be correct for each fieldbus. If the order of bytes transmitted to 16-bit inputs and outputs is handled incorrectly, incorrect data may be written to the Modbus device configuration or command registers, leading to unintended equipment operation.

Failure to follow this instruction may result in death, serious injury, or equipment damage.

4. Software Implementation of the Gateway

- **Sample reading of a motor starter parameter:**

Reading of the 1st fault register (address = 452 = 0x01C4) on “TeSys U n°5” motor starter. The initial values of O:1.16 and I:1.16 are equal to 0x1306. The result of the reading is 0x0002 (magnetic fault).

Output	Value	Meaning (MSB + LSB)
O:1.10	0x0305	Function no. + Slave no.
O:1.11	0xC401	Parameter address (MSB↔LSB)
O:1.12	0x0100	Number of parameters (MSB↔LSB)
O:1.16	0x1307	“Trigger byte” for the query (Pf)

Input	Value	Meaning (MSB + LSB)
I:1.10	0x0500	Slave no. + (not used)
I:1.11	0x0203	Number of bytes + Function no.
I:1.12	0x0200	Value read (MSB↔LSB)
I:1.16	0x1307	“Trigger byte” for the response (Pf)

- **Sample writing of a motor starter parameter:**

Writing of the 2nd command register (address = 705 = 0x02C1) on “TeSys U n°7” motor starter at the value 0x0006 (clear statistics + reset thermal memory). The initial values of O:1.16 and I:1.16 are equal to 0x1307. The result of the writing is a command echo, that is to say that the values of the “address parameter” and “value to be written” fields are identical in both the query and the response.

Output	Value	Meaning (MSB + LSB)
O:1.13	0x0607	Function no. + Slave no.
O:1.14	0xC102	Parameter address (MSB↔LSB)
O:1.15	0x0600	Value to be written (MSB↔LSB)
O:1.16	0x1407	“Trigger byte” for the query (PF)

Input	Value	Meaning (MSB + LSB)
I:1.13	0x0607	Function no. + Slave no.
I:1.14	0xC102	Parameter address (MSB↔LSB)
I:1.15	0x0600	Value to be written (MSB↔LSB)
I:1.16	0x1407	“Trigger byte” for the response (PF)

There is no error check performed on data transmitted using the aperiodic services described above. Incorrect values written to the outputs that correspond to the aperiodic communication services will lead to the transmission of an incoherent Modbus frame. This incoherent Modbus frame may return an error, or lead to unexpected behavior of the slave devices.

WARNING

RISK OF UNINTENDED EQUIPMENT OPERATION

The user must perform error checking and appropriate error handling for values written to the outputs corresponding to the aperiodic communications services. Incorrect values sent to the aperiodic services outputs can lead to unexpected system behavior.

Failure to follow this instruction may result in death, serious injury, or equipment damage.

5. Gateway Initialization and Diagnostics

The chapter describes the principle used to initialize and carry out diagnostics on the gateway using each of the three options offered by the gateway. These options can be configured via ABC-LUFP Config Tool, by changing the assignment of the "Control/Status Byte" field for the "ABC" element (see chapter 6.12.2). These options are:

<u>"Control/Status Byte" field:</u>	<u>Meaning:</u>
Enabled	Full Management
Enabled but no startup lock	Diagnostic Only
Disabled	Simplified Operation

The option chosen in the default configuration is "Enabled but no startup lock."

Full Management	Management in the PLC application of : → Start-up of Modbus cyclic exchanges → Modbus network diagnostic.
Diagnostic Only	Management in the PLC application of : → Modbus network diagnostic.
Simplified Operation	→ Automatic start-up of Modbus cyclic exchanges → No Modbus network diagnostic

5.1. Full Management

The DeviceNet master manages the start-up of Modbus cyclic exchanges and Modbus network diagnostic by means of 2 words:

- A DeviceNet Command Word
which is transmitted by the PLC application,
and is associated to addresses 0x0200 and 0x0201 of the gateway output memory
- A Gateway Status Word
which is transmitted by the gateway
and is associated to addresses 0x0000 and 0x0001 of the gateway input memory

The Gateway Status Word is not refreshed cyclically. The updating of this word is based on a toggle-bit system which must be managed in the PLC application:

- Diagnostic is refreshed by the gateway using toggle bit B15
- New command from the DeviceNet master is sent using toggle bit B14

5.1.1. DeviceNet Master Command Word

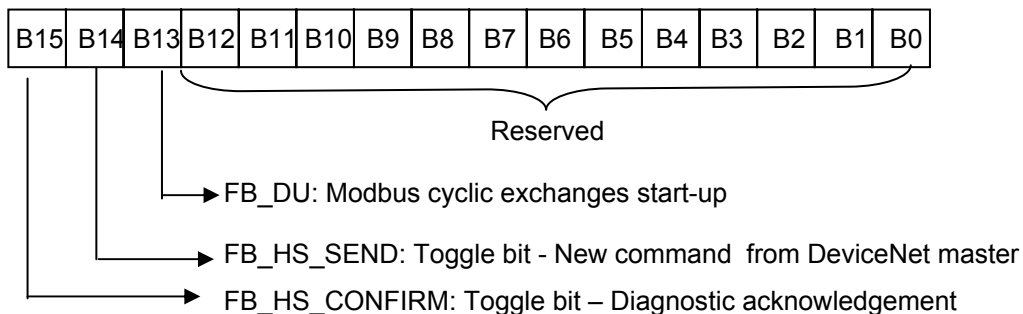

See the detailed description of each bit in chapter 5.4.

5. Gateway Initialization and Diagnostics

5.1.2. Gateway Status Word

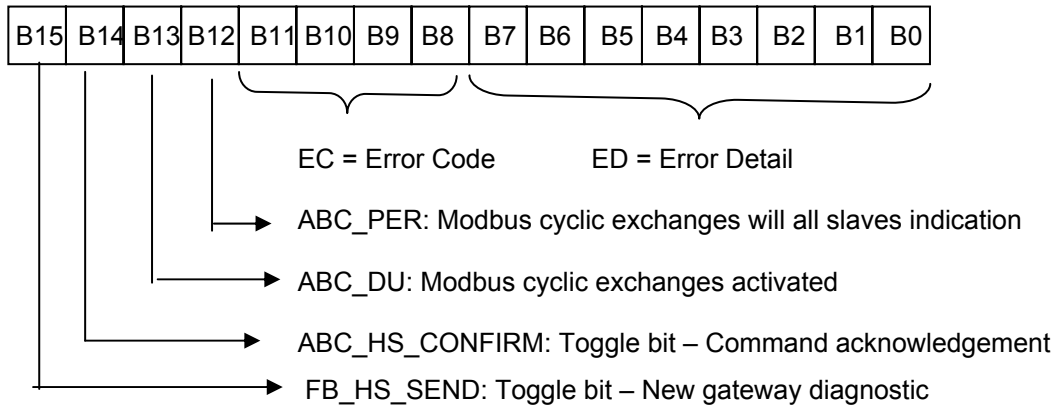

See the detailed description of each bit in chapter 5.5.

5.2. Diagnostic Only

The DeviceNet master manages only the Modbus network diagnostic using the same 2 words as those of Full Management.

Bits concerning Modbus cyclic exchanges management are inactive.

5.2.1. DeviceNet Master Command Word

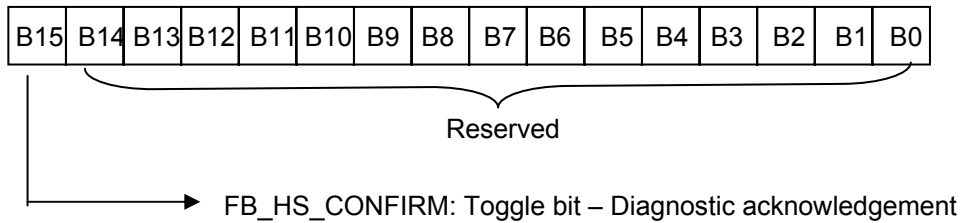

See the detailed description of each bit in chapter 5.4.

5. Gateway Initialization and Diagnostics

5.2.2. Gateway Status Word

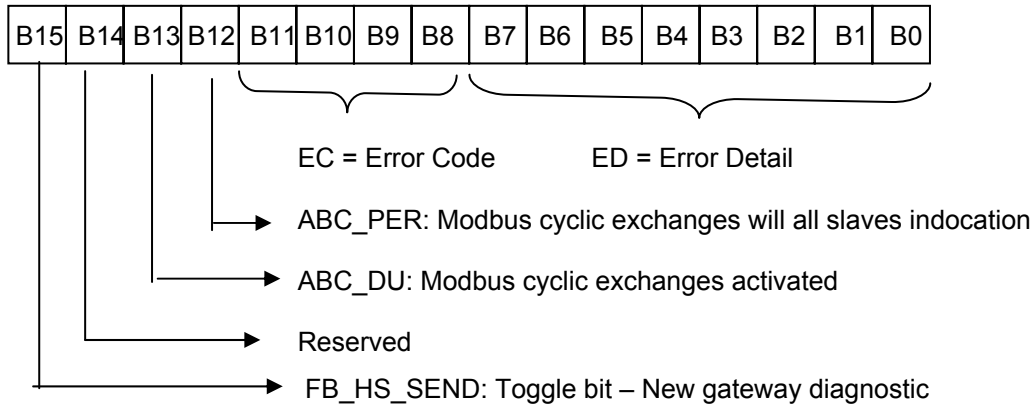

See the detailed description of each bit in chapter 5.5.

In the "Full management" and "Diagnostic only" modes, it is important that you configure your DeviceNet master so that it has access to the first two bytes of the gateway's output data area, as well as to the first two bytes of the gateway's input data area.

⚠ WARNING
MISCONFIGURATION OF LUPP• GATEWAY'S DATA AREAS
Configure your DeviceNet master so that it has access to the first two bytes of the gateway's output data area, as well as to the first two bytes of the gateway's input data area. Failure to configure access to these bytes can result in an inability to stop Modbus communications, and prevent logging of error conditions for later evaluation. Either consequence may cause unintended equipment operation.
Failure to follow this instruction may result in death, serious injury, or equipment damage.

See chapter 4.2 Configuring the Gateway in RSNetWorx, for more information.

5.3. Simplified Operation

The two 16-bit registers located at addresses 0x0000-0x0001 (inputs) and 0x0200-0x0201 (outputs) are no longer used. Thus, these two addresses can be used to exchange data with the Modbus slave.

No diagnostic is sent back to the PLC. The DeviceNet master's command word and the gateway's status word do not exist during simplified operations.

5. Gateway Initialization and Diagnostics

5.4. Description of the DeviceNet Master Command Word

The output word located at addresses 0x0200 (MSB) and 0x0201 (LSB) in the gateway's output memory constitutes the DeviceNet master command word. Its structure is described below:

Bits	Description
15	<p>FB_HS_CONFIRM: Acknowledgement bit of a gateway diagnostic</p> <p>The DeviceNet master must compare the value of the FB_HS_CONFIRM bit to the value of the ABC_HS_SEND bit (bit 15 in the gateway's status word). If these two values are different, this means that the gateway has transmitted a new diagnostic to the DeviceNet master.</p> <p>To tell the gateway that it has read a diagnostic, the DeviceNet master must copy the value of the ABC_HS_SEND bit to the FB_HS_CONFIRM bit. This allows the gateway to issue a new diagnostic.</p> <p>Summary:</p> <ul style="list-style-type: none">• If (FB_HS_CONFIRM = ABC_HS_SEND) → The gateway's status word contains a diagnostic which has already been acknowledged by the DeviceNet master. So the gateway is free to use this status word to place another diagnostic there.• Else → A new diagnostic is available in the gateway's status word. The DeviceNet master can read this diagnostic, but must also copy the value of ABC_HS_SEND to FB_HS_CONFIRM in order to allow the gateway to generate new diagnostics.
14	<p>FB_HS_SEND: Toggle bit - New command from the DeviceNet master (Reserved if "Diagnostic Only")</p> <p>Before changing the value of FB_DU, the DeviceNet master must compare the values of FB_HS_SEND and ABC_HS_CONFIRM (bit 14 of the gateway's status word). If these two values are different, this means that the gateway has not yet acknowledged the previous DeviceNet master command. Else, the DeviceNet master can issue a new command, updating the FB_DU bit according to the nature of its command (shutdown or activation of Modbus exchanges), then toggling the value of the FB_HS_SEND bit to inform the gateway that it has sent it a new command.</p> <p>Summary:</p> <ul style="list-style-type: none">• If (FB_HS_SEND ≠ ABC_HS_CONFIRM) → The DeviceNet master command word still contains a command which has not yet been acknowledged by the gateway. So the DeviceNet master cannot use this word to place a new command in it.• Else → The previous command of the DeviceNet master has been acknowledged by the gateway, which allows it to transmit a new command. In this case, it changes the value of the FB_DU bit, then toggles the value of the FB_HS_SEND bit.
13	<p>FB_DU: Modbus exchange startup (Reserved if "Diagnostic Only")</p> <p>The setting of this bit to one by the DeviceNet master allows communications between the gateway and the Modbus slaves. Resetting it to zero is used to inhibit them.</p> <p>When the DeviceNet master sets this bit to one, it is preferable for all of the output data it has placed in the gateway's output memory to be up-to-date ("FB_DU" means "FieldBus – Data Updated"). If they are not, this data will be transmitted to the Modbus slaves "as is".</p>
0-12	Reserved.

5. Gateway Initialization and Diagnostics

Due to the inversion of the LSB and the MSB for this register between the gateway and the DeviceNet master, the structure of the corresponding output word ("O:1.1" in the case of the default configuration) is as follows:

Bits	Description
8-15	Reserved.
7	FB_HS_CONFIRM: Acknowledgement bit of a gateway diagnostic
6	FB_HS_SEND: New DeviceNet master command word (<i>Reserved if "Diagnostic Only" mode</i>)
5	FB_DU: Modbus exchange startup (<i>Reserved if "Diagnostic Only" mode</i>)
0-4	Reserved.

e.g. If the O:1.1 output word is set to 0x00A0, the DeviceNet master command word will be set to 0xA000.

The correct use of this command word by the DeviceNet master, to transmit a new command to the gateway, goes through the following steps:

- Checking of (FB_HS_SEND = ABC_HS_CONFIRM).
- ↳ The command, that is to say the value of the FB_DU bit, is updated.
- ↳ The value of the FB_HS_SEND bit is inverted.

NOTE: It is possible to simplify this use as follows:

- The FB_DU and FB_HS_SEND bits are set to one to activate the Modbus communications.
- The FB_DU and FB_HS_SEND bits are reset to halt Modbus communications.

Though both 8-bit and 16-bit writes to the DeviceNet Master Command Word are permissible in theory, writing directly to the DeviceNet master command word in 16-bit format can cause errors. Such 16-bit writes can disrupt the operation of the transfer of the gateway diagnostics (undesired change to FB_HS_CONFIRM).

WARNING

RISK OF UNINTENDED EQUIPMENT OPERATION

Do not write 16-bit data directly to the DeviceNet master command word. Writing to this word using a 16-bit format can disrupt the transfer of Gateway diagnostics information to the master. Depending on the user's configuration, unintended equipment operation may result.

Failure to follow this instruction may result in death, serious injury, or equipment damage.

5. Gateway Initialization and Diagnostics

5.5. Description of the Gateway Status Word

The input word located at addresses 0x0000 (MSB) and 0x0001 (LSB) in the gateway's input memory constitutes the gateway's status word. Its structure is described below:

Bits	Description
15	ABC_HS_SEND: New gateway diagnostic (See description of bit 15 of the DeviceNet master command word, FB_HS_CONFIRM.)
14	ABC_HS_CONFIRM: Acknowledgement bit of a DeviceNet master command (Reserved if "Diagnostic Only") (See description of bit 14 of the DeviceNet master command word, FB_HS_SEND.)
13	ABC_DU: Modbus exchanges activated The gateway activates this bit to tell the DeviceNet master that all Modbus data located in its input memory area has been updated at least once since the last activation of FB_DU ("ABC_DU" means "ABC – Data Updated"). This Modbus input data includes every data in responses from all Modbus slaves, for both periodic commands and aperiodic commands. This bit is deactivated by the gateway when the FB_DU bit is deactivated, that is to say when the DeviceNet master demands a shutdown of Modbus exchanges. NOTE: Once it is active, this bit is not deactivated if there are any communication errors with the Modbus slaves. To signal this type of error, the gateway uses bit 12 of its status word.
12	Periodicity of Modbus exchanges The gateway activates this bit provided that it is periodically communicating with all of the Modbus slaves. It deactivates it as soon as it loses communication with one of them. The "Reconnect time (10ms)", "Retries" and "Timeout time (10ms)" elements of each of the Modbus queries (see chapter 6.11.2.2) are used to determine whether communication is lost, then restored. NOTE: If a number of periodic exchanges are configured for the same Modbus slave, only one of them needs to remain active for the periodic communications with this slave to be declared active.
8-11	EC: Error code associated with the Modbus network Code for the error detected on the Modbus network by the gateway and transmitted to the DeviceNet master (see EC-ED table).
0- 7	ED: Error data item associated with the Modbus network Data item associated with the EC error code (see EC-ED table).

Due to the inversion of the LSB and the MSB for this register between the gateway and the DeviceNet master, the structure of the corresponding input word ("I:1.1" in the case of the default configuration) is as follows:

Bits	Description
8-15	ED: Error data item associated with the Modbus network
7	ABC_HS_SEND: New gateway diagnostic
6	ABC_HS_CONFIRM: Acknowledgement bit of a DeviceNet master command (Reserved if "Diagnostic Only" mode)
5	ABC_DU: Modbus exchanges activated
4	Periodicity of Modbus exchanges
0-3	EC: Error code associated with the Modbus network

E.g. If the gateway's status word is set to 0xF031, the input word I:1.1 will be set to 0x31F0.

5. Gateway Initialization and Diagnostics

The correct use of this status word by the DeviceNet master, to read a diagnostic generated by the gateway, goes through the following steps:

- Checking of (ABC_HS_SEND ≠ FB_HS_CONFIRM).
- ↳ Reading of the value of ABC_DU to determine whether all of the Modbus input data are up-to-date.
- ↳ Reading of the value of the “Periodicity of Modbus exchanges” bit to determine whether the periodicity of the Modbus communications has been maintained.
- ↳ Reading of the values of EC and ED to check for any error detected by the gateway on the Modbus network (see table below).
- ↳ Copying of the value of the ABC_HS_SEND bit to the FB_HS_CONFIRM bit.

This last step is very important if the system is designed to read the gateway diagnostics and perform some action depending on the result. Copying of the value of the ABC_HS_SEND bit to the FB_HS_CONFIRM bit allows the gateway to transmit a future diagnostic, preventing the loss of subsequent error information.

 WARNING
RISK OF UNINTENDED EQUIPMENT OPERATION
The user must ensure the DeviceNet master programming concludes read operations by copying the value of the ABC_HS_SEND bit to the FB_HS_CONFIRM bit. If this step is omitted in applications where gateway diagnostics will be read and acted upon, future diagnostics information will be blocked. Depending on the user's configuration, unintended equipment operation may result.
Failure to follow this instruction may result in death, serious injury, or equipment damage.

The values of the EC and ED fields are described in the table below:

EC	Description of the error	ED	Notes
2#0000	Re-transmissions on the Modbus network	Number of re-transmissions	Total number of re-transmissions carried out on the sub-network, for all slaves.
2#0001	A Modbus slave is missing	Address of the missing Modbus slave	—
2#0010	Several Modbus slaves are missing	—	—
2#0011	Excessive data in a Modbus response	Address of the Modbus slave involved	This error occurs when the gateway receives too much data in the response sent by one of its Modbus slaves.
2#0100	Unknown Modbus error	Address of the Modbus slave involved	—

The re-transmission counter used to signal this error is not reset when the gateway generates this error code. If there are recurrent communication problems on the Modbus network, the gateway will generate this same diagnostic repeatedly, so as to tell the DeviceNet master the total number of re-transmissions carried out as often as possible. This counter is reset when its value exceeds its maximum value (counter modulo 256: 0xFF → 0x00).

In the case of de-connection of one or several devices on the Modbus sub-network, the LUF9 gateway will first report re-transmission errors several times and then the error “A Modbus slave is missing” or “Several Modbus slaves are missing”. Later on when the LUF9 makes a reconnection attempt, only the re-transmission error will be reported. Due to this, the indication of the errors “A Modbus slave is missing” or “Several Modbus slaves are missing” may be perceived as very brief.

6. Configuring the Gateway

Each part of this chapter describes a separate step allowing the user to personalize the gateway configuration, according to his own particular needs. Each part gives an introduction to a basic operation isolating it from the rest of the configuration and describing the operations to be carried out using ABC-LUFP Config Tool (mainly) and RSNNetWorx (where necessary), and their implications for the gateway's general behaviour.

In each case, the first two steps are required, as they allow you to establish the dialogue between the gateway and the PC software allowing you to configure it, that is to say ABC-LUFP Config Tool.

We strongly recommend that you read chapter 4 Software Implementation of the Gateway, because all of the operations carried out in ABC-LUFP Config Tool or RSNNetWorx are based on the principle that we are using the default configuration of the LUFP9 gateway.

6.1. Connecting the Gateway to the Configuration PC

This step is required when setting up the gateway configuration application, ABC-LUFP Config Tool.

Connecting the gateway to one of the serial (COM) ports on a PC requires a straight PowerSuite cable and a RS232/RS485 converter. These two items are the same as those allowing dialogue with drives and soft start-stop units using the **PowerSuite** application and are both available from the catalogue (ref.: VW3 A8 106).

Ensure that you use the "POWERSUITE" cable and the "RS232 / RS485 PC" converter. An "ATV28 before 09 / 2001" cable and an "ATV 58" converter are also supplied with these items, but they should not be used with the LUFP9 gateway.

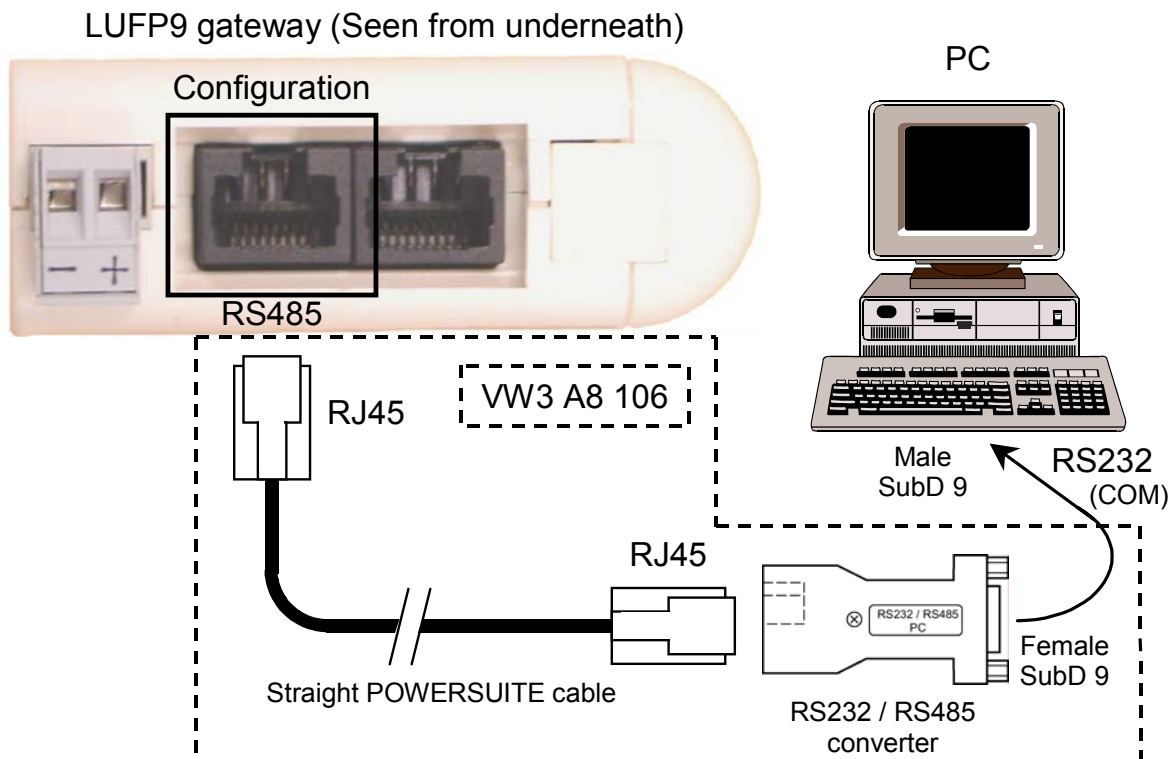

Once the gateway has been connected to a PC with the PowerSuite cable and the RS232/RS485 converter, you can change its configuration using "ABC-LUFP Config Tool". This configurator also allows you to carry out a few diagnostics on the gateway.

6. Configuring the Gateway

6.1.1. Pin Outs

— LUF9 (Configuration) —

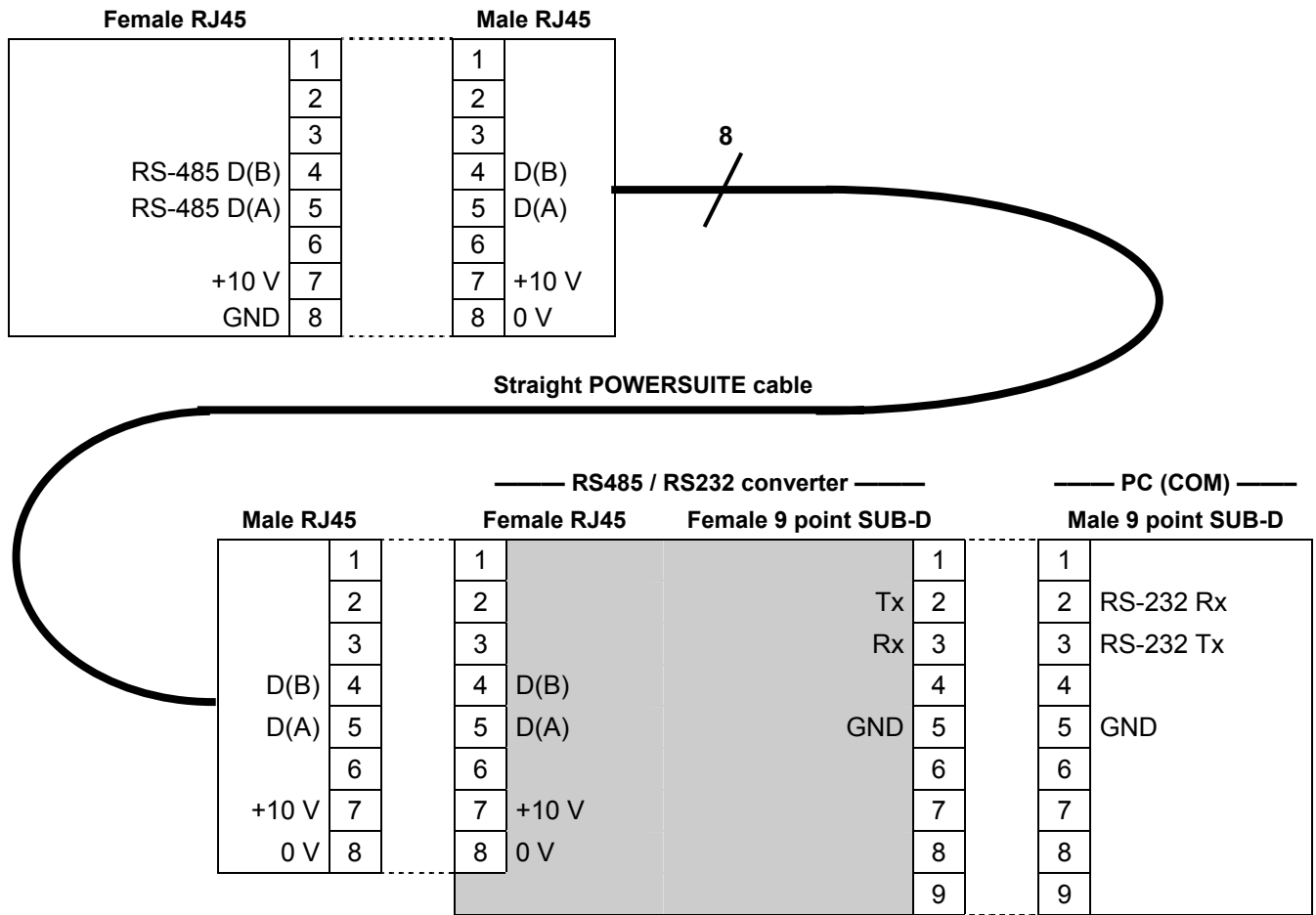

NOTE: The inversion of the Rx and Tx signals between the gateway and the PC is shown on the 9-point SUB-D connectors, because beyond this junction, the RS-232 signals are replaced by the D(A) and D(B) polarisations of the RS-485 signals.

6.1.2. RS-232 link protocol

There is no need to configure the PC's COM port, as ABC-LUFP Config Tool uses a specific setup which replaces the one for the port being used. This replacement is temporary and is cancelled as ABC-LUFP Config Tool is closed.

6. Configuring the Gateway

6.2. Installing ABC-LUFP Config Tool

The minimum system requirements for ABC-LUFP Config Tool are as follows:

- Processor Pentium 133 MHz
- Free hard disk space 10 Mb
- RAM 8 Mb
- Operating system MS Windows 95 / 98 / ME / NT / 2000 / XP
- Browser MS Internet Explorer 4.01 SP1

The ABC-LUFP Config Tool installation program can be found on the PowerSuite CD (ref. VW3 A8 104). To install it, run “ABC-LUFP_Setup.exe”, then follow the on-screen instructions

You can read about how to use ABC-LUFP Config Tool in a user manual entitled **AnyBus Communicator – User Manual** which is also on the PowerSuite CD: “ABC_User_Manual.pdf”. We strongly recommend that you read this manual when using ABC-LUFP Config Tool, because this guide will only describe the various features it provides in relation to using the LUFP9 gateway.

6.3. Importing the Gateway Configuration

Before you can make any changes to the gateway configuration, you will first need to import its current configuration. If you already have this configuration on your hard disk, all you will need to do is open the file corresponding to this configuration.

Check that the gateway has a valid configuration and that it is working properly, that is to say that LED ⑥ DEVICE STATUS is flashing green.

In ABC-LUFP Config Tool, choose “Upload configuration from ABC-LUFP” from the “File” menu or click on the  button, in the toolbar. A window called “Upload” will then open and a progress bar shows you the state of progress of the gateway configuration uploading process. This window disappears as soon as the whole configuration has been uploaded successfully.

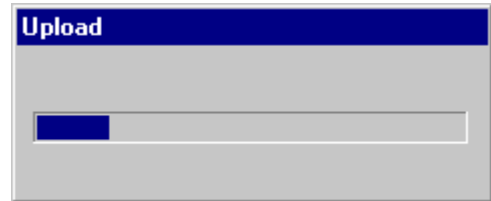

This step is particularly important if you wish to read details about the content of the gateway’s default configuration, after unpacking it. You can then use this configuration as a template for any changes you wish to make subsequently, thus avoiding having to create all of the items and reducing the potential risk of error.

NOTE:

- Save this configuration to your hard disk so that it is always available. This will allow you to reconfigure the gateway “cleanly”, should the configuration become invalid.
- The LUFP9 gateway’s default configuration can be found on the CD LU9CD1 : “LUFP9.cfg”.

6. Configuring the Gateway

6.4. Transferring a Configuration to the Gateway

When using ABC-LUFP Config Tool, you can transfer the configuration you are editing to the gateway at any time.

Choose “Download configuration to ABC-LUFP” from the “File” menu or click on the  button, in the toolbar.

ABC-LUFP Config Tool initializes a check test of the gateway type.

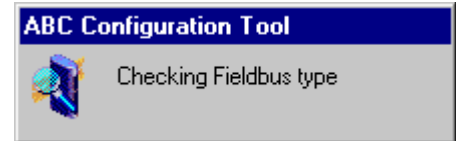

NOTE: During this test, the PC should not carry out any other operations, as this could lead to ABC-LUFP Config Tool apparently freezing up and slow down the PC's general operation for several minutes. After the test is complete, the PC will return to full speed, and may be used normally.

Once this test has finished, a window called “Download” opens and a progress bar shows the state of progress for the transfer of the configuration to the gateway.

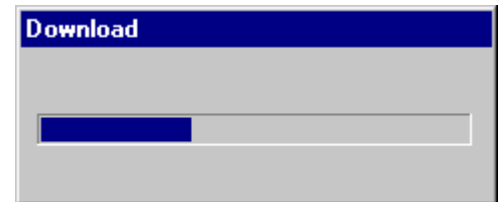

NOTE: Do not interrupt this operation, otherwise you will have to start it again from the beginning.

Check that the transfer has been correctly carried out: LED  DEVICE STATUS should be flashing green.

If this LED is flashing red/green, save the configuration you were editing, open the file containing the default configuration for LUFP9 gateways, then transfer it to the gateway. This will restore it to a known initial state. You can then continue with the configuration you were transferring, and make any corrections which may be necessary.

6.5. Monitoring the Content of the Gateway's Memory

One of the main commands that you will need to use when setting up the gateway is the command allowing you to read the contents of the gateway's memory and to display it in a window used for this purpose. This will be particularly useful when you are working on your PLC configurations and applications. However, it only shows data from the “Data” and “Preset Data” fields configured in the “Query” and “Response” elements of just one of the Modbus slaves, plus the content of the gateway's two reserved registers, located at memory addresses 0x0000-0x0001 (gateway status word) and 0x0200-0x0201 (DeviceNet master command word).

To monitor the content of the gateway's memory, start by selecting the node corresponding to the Modbus slave whose data you wish to view, then choose “Monitor” from the menu whose name corresponds to the name of the previously selected node. A monitoring window then appears. The sample window shown at the top of the next page corresponds to a view of the contents of the memory exchanged, using the gateway's default configuration, with the “TeSys U n°1” motor starter.

6. Configuring the Gateway

Slave Address	Function	Starting Address (Hi,Lc)	Number of points (Hi,Lc)	Checksum	Error check type	Error check start byte
0x01	0x01	0x0000	0x0000		CRC	0x0000

Slave Address	Function	Byte count	Data	Checksum

0000	E1	1	0	0
0007				
000E				1 3
0015	2	0	80	1 6 2 5F
001C	0	78	7	13
0023				

0200	60	0	0	0
0207				
020E				1 3 2
0215	72	0	1	1 6 2 5F
021C	0	78	7	13
0223				

0400				
0407				
040E				
0415				
041C				
0423				

The upper part of this window allows you to choose a Modbus command, to edit its contents, then to send it to the Modbus network (“Command” menu). The response will then be displayed in this same part. Please see chapter 2.10 Node monitor in the ABC-LUFP Config Tool user manual, entitled **AnyBus Communicator – User Manual**, for further information about how to use this window. This manual can be found on the CD LU9CD1: “ABC_User_Manual.pdf”.



The lower part of this window allows you to view the content of the gateway’s memory, but only the bytes used in queries and responses frames for commands and transactions configured for the selected node. The values of the gateway’s two reserved words (addresses 0x0000-0x0001 and 0x0200-0x0201) are also shown, whichever node is selected.

In the window shown above, the data displayed correspond to the values at the memory locations designated by the “Data” fields in the commands and transactions configured for the “TeSys U no. 1” node, that is to say the following commands: “Read Holding Registers”, “Preset Multiple Registers”, “Transactions 1”, and “Transactions 2”.

NOTE: The data exchanged with the Modbus slave previously selected are displayed LSB-first, that is in the LSB / MSB order (as read from left to right, with growing memory addresses), provided that the “Byte Swap” option from the “Data” or “Preset Data” element of the corresponding Modbus command was set to “Swap 2 bytes” (see chapter 6.11.2.5 Configuring the Content of the Response Frame). For the two reserved words dedicated to the management of the downstream Modbus network, it is the contrary: MSB-first.

However, but only as far as the “TeSys U n°1” node is concerned, the data beginning at addresses 0x0013, 0x0018, 0x0212, and 0x0218 (see Appendix B: Content of the Gateways’s DPRAM Memory) follow the same byte order as the content of the frames they are related to (see Appendix E: Modbus Commands), from first to last byte (checksum excluded), and following growing addresses in the memory of the gateway. Finally, bytes 0x001E, 0x001F, 0x021E, and 0x021F correspond to the reception and emission counters for these frames (“Trigger bytes” from Transactions 1 and 2). But *all these bytes* are swapped two by two between the gateway and the DeviceNet master.

A brief description of the toolbar buttons of this window is given below:

-  Stop / Start communications with the selected node.
-  Select / Send the Modbus command shown in the upper part of the window
-  Stop / Resume refreshing the data displayed in the lower part of the window

6. Configuring the Gateway

6.6. Deleting a Modbus Slave

This step allows you, for instance, to free up a location on the downstream Modbus network, known as the “Sub-Network” in ABC-LUFP Config Tool, in order to replace one Modbus slave with another.

In fact the gateway’s default configuration allows it to communicate with eight TeSys U motor starters, which is the maximum number of Modbus slaves.

If the gateway is used to manage exchanges on a Modbus network with fewer than eight TeSys U motor starters, it is preferable to delete the redundant TeSys U motor starters from the gateway. You should carry out this operation using ABC-LUFP Config Tool.

If you are using the aperiodic read/write services, keep in mind that these services are configured using the memory space of the first configured TeSys U Motor starter. Therefore, deleting the first configured TeSys U Motor starter can also result in the deletion of the aperiodic read/write services

 WARNING
LOSS OF APERIODIC COMMUNICATIONS
Do not delete the first configured TeSys U motor starter if you are using the aperiodic read/write services. Deleting this first device will also delete the aperiodic services. Because these services allow communication with all of the configured Modbus devices, and not just the first device, you may lose communications with all devices, leading to unintended equipment operation.
Failure to follow this instruction can result in death, serious injury, or equipment damage.

Procedure for deleting a Modbus slave

- 1) Select the node corresponding to the Modbus slave you wish to delete from the configuration. If this is the only node remaining in the configuration, you will not be able to delete it, as the downstream Modbus network must include at least one slave.
- 2) Right click on the icon or the name of this Modbus slave. A menu pops up underneath the mouse cursor.
or
In the ABC-LUFP Config Tool main menu, pull down the menu whose name corresponds to the name of the previously selected node.
- 3) On this menu, click on “Delete”. The confirmation window shown below then appears, asking you to either confirm that you want to delete the selected node (“TeSys U no. 2” in the example shown here) or cancel the operation.
- 4) If you confirm that you want to delete the node, the menu disappears, along with the previously selected node. Otherwise, the node will still be there once the window disappears.

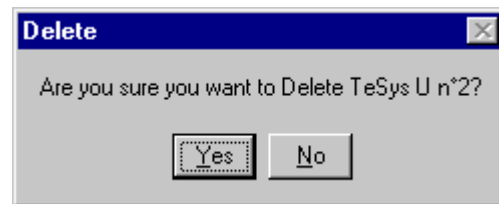

Keyboard shortcut: “Del” key.

Adjusting the gateway’s memory (optional step):

The data previously exchanged between the gateway and the Modbus slave which has just been deleted will free up locations in the gateway’s memory. If you want to optimize the exchanges between the gateway’s memory and the master PLC DeviceNet scanner inputs/outputs, you will need to change the configuration of all the other Modbus slaves in order to adjust the content of the gateway’s memory.

6. Configuring the Gateway

However, these operations are not necessary when deleting a single slave. Conversely, they become almost essential when most of the Modbus slaves are deleted, because these deletions divide up the gateway's memory.

Please see chapter 6.11 Adding and Setting Up a Modbus Command, which describes all of the changes you can make to the configuration of each of the Modbus commands.

6.7. Adding a Modbus Slave

This operation allows you to add a Modbus slave whose type is different from those of the other Modbus slaves in the configuration. On the other hand, if the slave type is the same as one of the previously configured slaves, it is preferable to copy this slave rather than to create a new one.

An additional import/export feature also allows you to individually save the complete configuration of a Modbus slave, in order to have access to it in ABC-LUFP Config Tool, from any configuration and at any time.

These two features are only available provided that there are less than 8 Modbus slaves declared, which is not the case in the default configuration, as it comprises 8 TeSys U motor starters.

Adding a new type of Modbus slave:

Use one of the two methods shown below:

- a) Select "Sub-Network", then choose "Add Node" from the "Sub-Network" menu. A new node is added after all the other configured nodes. By default, its name is "New Node".
- b) Select one of the nodes located under the "Sub-network" element, then choose "Insert New Node" from the menu whose name corresponds to the name of the selected node. A new node is added just before the selected node. By default, its name is "New Node".

All of the steps in configuring the new node are described in chapter 6.10 Changing a Modbus slave Configuration.

Copying a previously configured Modbus slave:

Select the node corresponding to the slave whose configuration you want to copy, then choose "Copy" from the menu whose name corresponds to the name of the selected node. **Keyboard shortcut:** "Ctrl C".

Then use one of the two methods shown below:

- a) Select "Sub-Network", then choose "Paste" from the "Sub-Network" menu. A new node is added after all the other configured nodes. Its name and its whole configuration are identical to that of the node you copied. **Keyboard shortcut:** "Ctrl V".
- b) Select one of the "Sub-Network" nodes, then choose "Insert" from the menu whose name corresponds to the selected node. A new node is added just before the one which is selected. Its name and the whole of its configuration are identical to that of the node you copied.

6. Configuring the Gateway

As the new node and the original node are identical in every way, you will need to change (1) the name of the node, (2) the address of the corresponding Modbus slave and (3) the location of the data exchanged between the gateway's memory and this Modbus slave. See chapter 6.10 Changing a Modbus slave Configuration, and chapter 6.11 Adding and Setting Up a Modbus Command.

WARNING

DUPLICATE MODBUS ADDRESSES OR GATEWAY MEMORY RANGES

If the user chooses to add a Modbus slave by copying the configuration of an existing Modbus slave, the user must change the added device's Modbus address and the memory locations it uses to exchange data with the gateway. Duplicated Modbus addresses or gateway memory locations may result in communications errors, incorrect information being written to a slave's registers, or in writing the registers of an unintended device. Any of these errors may result in unintended equipment operation.

Failure to follow this instruction may result in death, serious injury, or equipment damage.

Importing/exporting a Modbus slave configuration:

ABC-LUFP Config Tool offers the possibility of independently saving and loading the configuration of a node on the downstream "Sub-Network". For instance, this will allow you to build a library of Modbus slave templates, so that you can use them in any configuration.

To save the configuration of a Modbus slave, select the node it corresponds to, then choose "Save Node" from the menu whose name corresponds to the name of the selected node. A dialog box will then appear asking you to save the configuration (export in XML format).

To insert a node using the XML file containing a Modbus slave configuration as a template, use one of the two methods shown below:

- a) Select "Sub-Network", then choose "Load Node" from the "Sub-Network" menu. A dialog box asks you to choose a file containing a Modbus slave configuration (import in XML format). A new node is added after all the other configured nodes. Its name and its whole configuration are identical to those of the Modbus slave, as it was configured when it was saved.
- b) Select one of the "Sub-Network" nodes, then choose "Insert from File" from the menu whose name corresponds to the name of the selected node. A new node is added just before the selected node. Its name and its whole configuration are identical to those of the Modbus slave, as it was configured when it was saved.

You will then change (1) the name of the node, (2) the address of the corresponding Modbus slave and (3) the location of the data exchanged between the gateway's memory and this Modbus slave. See chapter 6.10 Changing a Modbus slave Configuration, and chapter 6.11 Adding and Setting Up a Modbus Command.

WARNING

DUPLICATE MODBUS ADDRESSES OR GATEWAY MEMORY RANGES

If the user chooses to add a Modbus slave by copying the configuration of an existing Modbus slave, the user must change the added device's Modbus address and the memory locations it uses to exchange data with the gateway. Duplicated Modbus addresses or gateway memory locations may result in communications errors, incorrect information being written to a slave's registers, or in writing the registers of an unintended device. Any of these errors may result in unintended equipment operation.

Failure to follow this instruction may result in death, serious injury, or equipment damage.

6. Configuring the Gateway

6.8. Changing Periodic Data Exchanged With a Modbus Slave

This operation consists of replacing, adding or deleting periodic data exchanged with one of the Modbus slaves. With each of these operations, we shall take the default configuration of the LUFFP9 gateway as an example, that is to say that any changes previously made will have been cancelled at the start of each operation. In addition, the operations to be carried out are shown as part of a targeted example.

Do not forget to save the changes you have made, or to transfer the whole configuration to the gateway. This will allow you to check that the configuration is valid, as the gateway automatically verifies the configuration when it is downloaded.

6.8.1. Replacing a Periodic Input Data Element

We will use the node corresponding to “TeSys U n°3” motor starter for our example. We are trying to replace the monitoring of the “TeSys U Status Register” (address 455 = 0x01C7) with the monitoring of the “1st Fault Register” (address 452 = 0x01C4).

The operation is a very simple one and consists purely of changing the value of the “Starting Address (Hi, Lo)” element of the “Query” from the “Read Holding Registers” command (Modbus command for reading the values of a number of registers).

Select this element, then change its value as shown below. You can enter the address of the parameter in decimal format. ABC-LUFFP Config Tool will automatically convert it to hexadecimal.

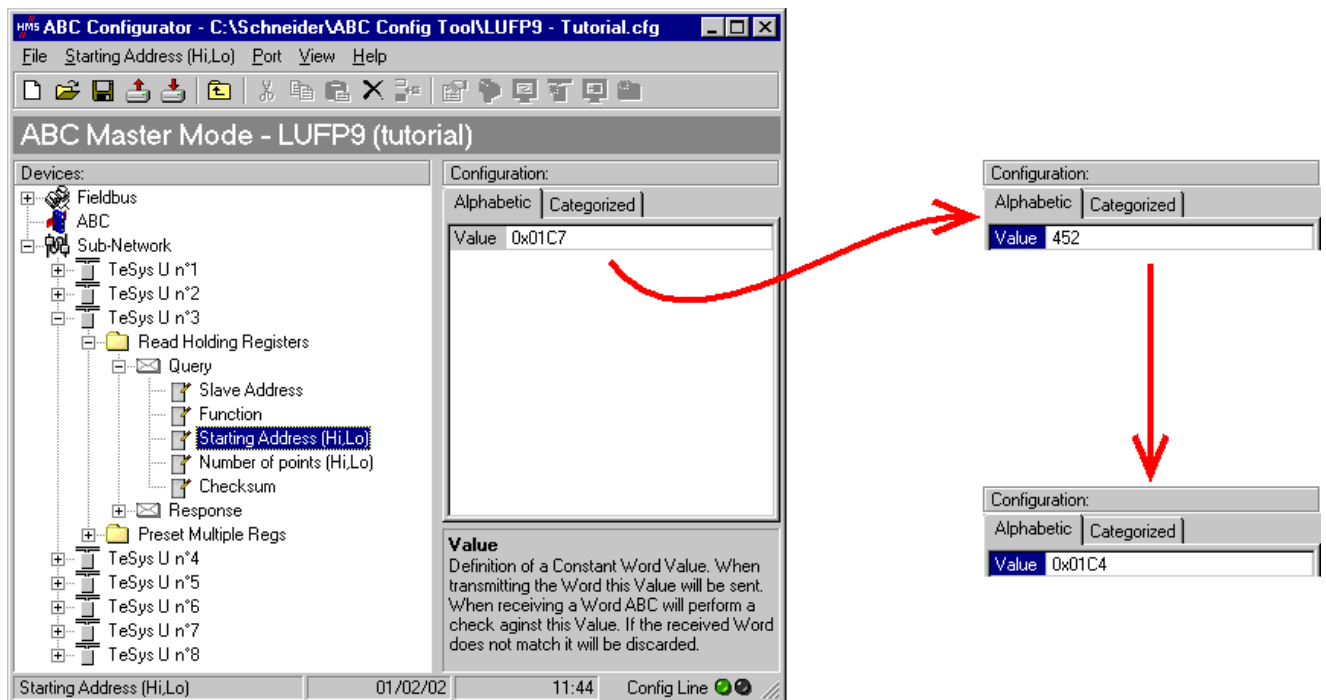

This operation in no way changes the configuration of the gateway’s memory, because we do not need to change the values of the “Data length” and “Data location” fields of the “Data” element of the “Response” to the aforementioned command. So no additional operations will be necessary, either in ABC-LUFFP Config Tool, or in RSNetWorx.

On the other hand, the DeviceNet master PLC software will have to take account of the change in the nature of the corresponding input. In the Appendix B:, Input Data Memory Area, the description of the word located at address 0x0006 becomes “value of the motor starter © 1st default register.” This word corresponds to the PLC input word I:1.4 (see chapter 4.2.6 Configuring Inputs from the Gateway).

6. Configuring the Gateway

6.8.2. Replacing a Periodic Output Data Element

We will use the node corresponding to “TeSys U n°6” motor starter for our example. We are trying to replace the control of the “Command Register” (address 704 = 0x02C0) with the control of the “2nd Command Register” (address 705 = 0x02C1).

The operation consists of changing the value of the “Starting Address” in the “Query” and in the “Response” for the “Preset Multiple Registers” command (Modbus command for writing values from a number of registers).

Select “Starting Address” from the “Query”, then change its value as shown below. You can enter the address of the parameter in decimal format. ABC-LUFP Config Tool will automatically convert it to hexadecimal. **Do the same for the “Starting Address” element of the “Response”** because the gateway checks the value of this field when it receives each Modbus response. If the value does not correspond to that of the query, the gateway will ignore the response.

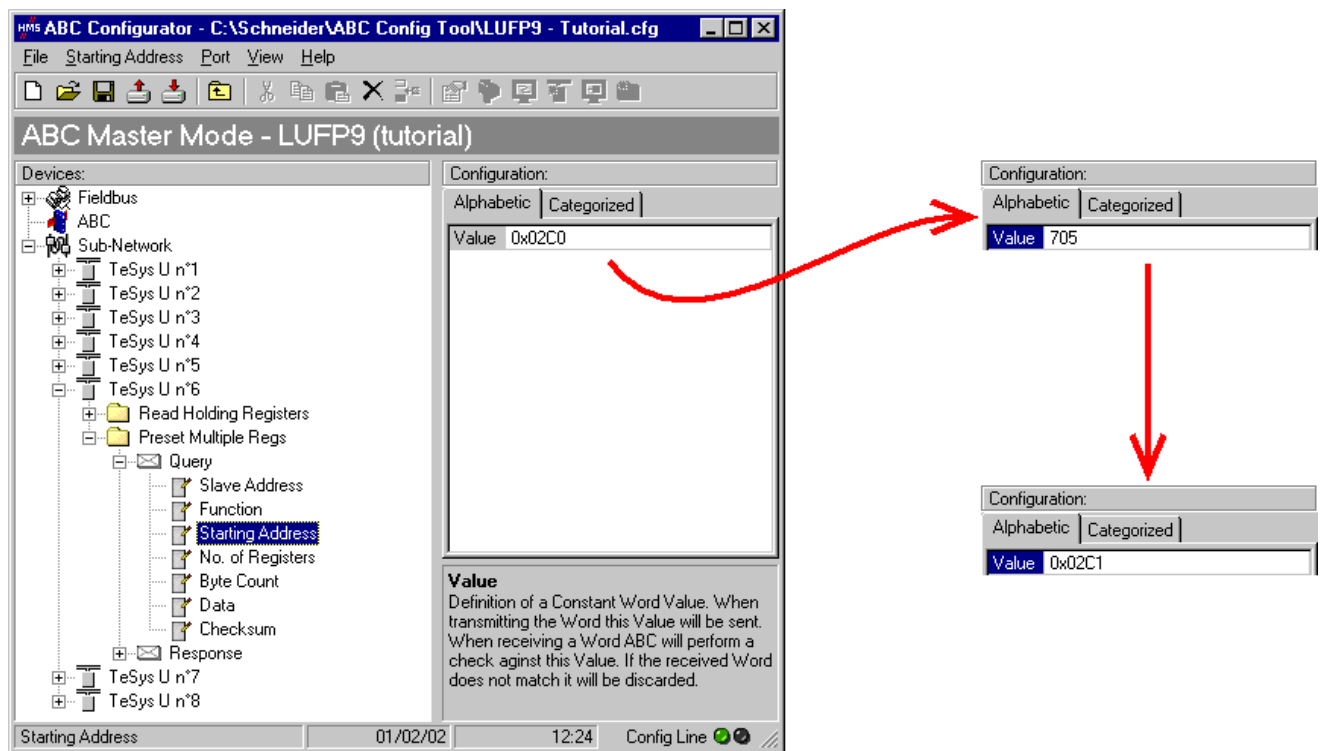

This operation in no way changes the content of the gateway’s memory, because we do not need to change the values of the “Data length” and “Data location” fields of the “Data” element of the “Query”. So no additional operations will be necessary, either in ABC-LUFP Config Tool, or in RSNetWorx.

On the other hand, the DeviceNet master PLC software will have to take account of the change in the nature of the corresponding output. In Appendix B: Output Data Memory Area, the description of the word located at address 0x020C becomes “value of the motor starter © 2nd command register.” This word corresponds to PLC output word O:1.7 (see chapter 4.2.7 Configuring Outputs Intended for the Gateway).

6. Configuring the Gateway

6.8.3. Increasing the Amount of Periodic Input Data

We will use the node corresponding to “TeSys U no. 2” motor starter for our example. We are trying to complete the monitoring of this motor starter starting from the currently monitored register, that is to say “TeSys U Status Register” (address 455 = 0x01C7), and going as far as the “Reserved: 2nd Warning Register” (address 462 = 0x01CE). The number of registers monitored is therefore increased from 1 to 8.

In this case, there are quite a lot of operations to be carried out. They are described in order below:

- 1) Changing the number of registers monitored: This step consists of changing the value of “Number of points (Hi, Lo)” element of the “Query” from the “Read Holding Registers” command (Modbus command for reading the values of a number of registers). Select this element, then change its value as shown below. ABC-LUFP Config Tool will automatically convert any value entered in decimal to hexadecimal.

The screenshot shows the ABC Configurator interface. The left pane displays a tree view with 'Number of points (Hi,Lo)' selected under the 'Query' command. The main pane shows the configuration for this element, with the 'Value' field set to '0x0001'. A red arrow points from this field to a zoomed-in view of the configuration dialog, where the value is changed to '8'. A second red arrow points down to another zoomed-in view where the value is '0x0008', demonstrating the automatic conversion from decimal to hexadecimal.

- 2) Changing the number of data bytes in the Modbus response: The number of bytes read from the “TeSys U n°2” motor starter memory increases from 2 to 16, as the number of registers monitored has increased from 1 to 8. Select the “Byte count” element from the “Response” and change its value as shown below. ABC-LUFP Config Tool will automatically convert any value entered in decimal to hexadecimal.

The screenshot shows the ABC Configurator interface. The left pane displays a tree view with 'Byte count' selected under the 'Response' command. The main pane shows the configuration for this element, with the 'Value' field set to '0x02'. A red arrow points from this field to a zoomed-in view of the configuration dialog, where the value is changed to '16'. A second red arrow points down to another zoomed-in view where the value is '0x10', demonstrating the automatic conversion from decimal to hexadecimal.

6. Configuring the Gateway

- 3) Changing the location of the Modbus data received in the gateway's memory: As the number of bytes read (see previous step) has increased from 2 to 16, the Modbus data received must be placed at a different location in the gateway's memory, and the size of the memory occupied must also be adjusted appropriately.

If you are not certain how much of the gateway's memory is currently occupied, select "Sub-Network" and choose "Monitor" from the "Sub-Network" menu. The following window appears, allowing you to see how much of the gateway's memory is occupied.

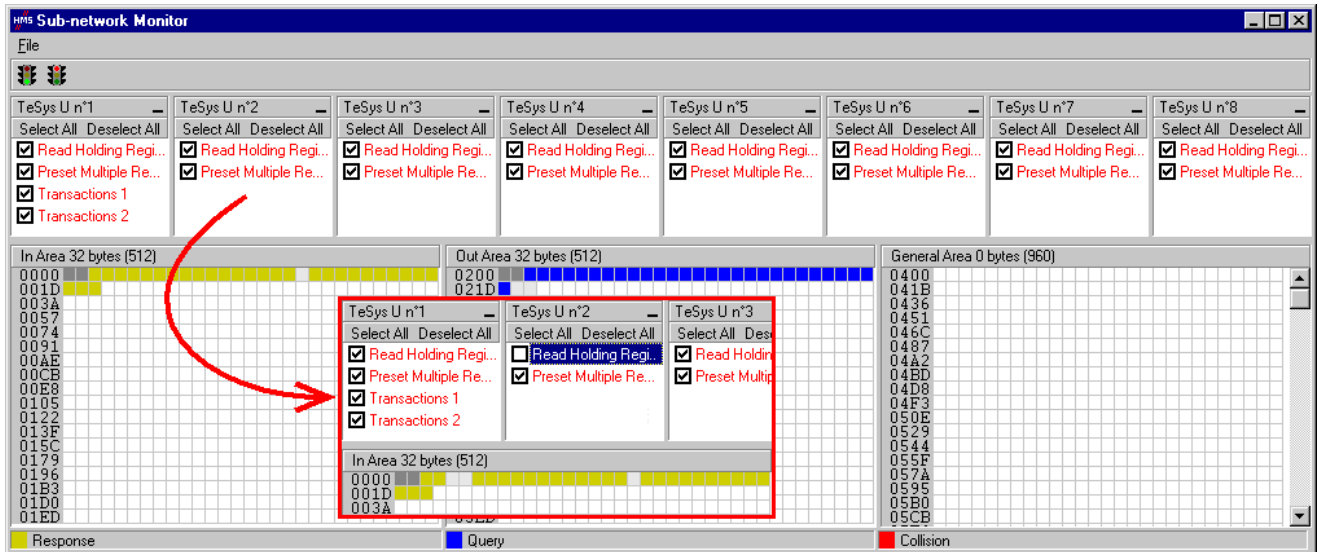

To see which memory locations are occupied by data from the command you are interested in, all you have to do is uncheck the box corresponding to the "Read Holding Registers" command from the "TeSys U n°2" node, as shown above. We can see that the Modbus data received in response to this command occupy 2 bytes located from address 0x0004.

NOTE: The memory locations 0x0000 and 0x0001 are reserved (see chapter 5 Gateway Initialization and Diagnostics). So you will not be able to place any Modbus data in these locations.

The sizes displayed above the graphics areas of this window ("In Area 32 bytes" and "Out Area 32 bytes") correspond to the total input and output sizes you must check under RSNetWorx (see point 6 on next page) and configure for the DeviceNet scanner (see point 7).

If you wish to place the 16 bytes of Modbus data which will be received by the gateway for this command into memory, once the changes have been made, we will have to move all the other input data by 14 bytes, which may be tedious, or change the memory location of the block of data received. In the example described here, we will be using the second solution, although the first solution is actually preferable, in principle, as it avoids leaving any "holes" in the gateway's memory, thus optimising the transfer of all of the data to the DeviceNet master PLC. Furthermore, the 1747-SDN scanner can only exchange 32 input words with the master PLC. Leaving "holes" of this sort in the gateway's memory is therefore not recommended in cases of large configurations.

So we will be placing the 16 bytes of data from address 0x0020 (32 in decimal), that is to say directly after the input data for the gateway's default configuration.

6. Configuring the Gateway

Close the “Sub-network Monitor” window, then once you are back in the main ABC-LUFFP Config Tool window, select the “Data length” and “Data location” fields of the “Data” element from the “Response” one after another and change their values as shown at the top of the next page. ABC-LUFFP Config Tool will automatically convert any value entered in decimal to hexadecimal.

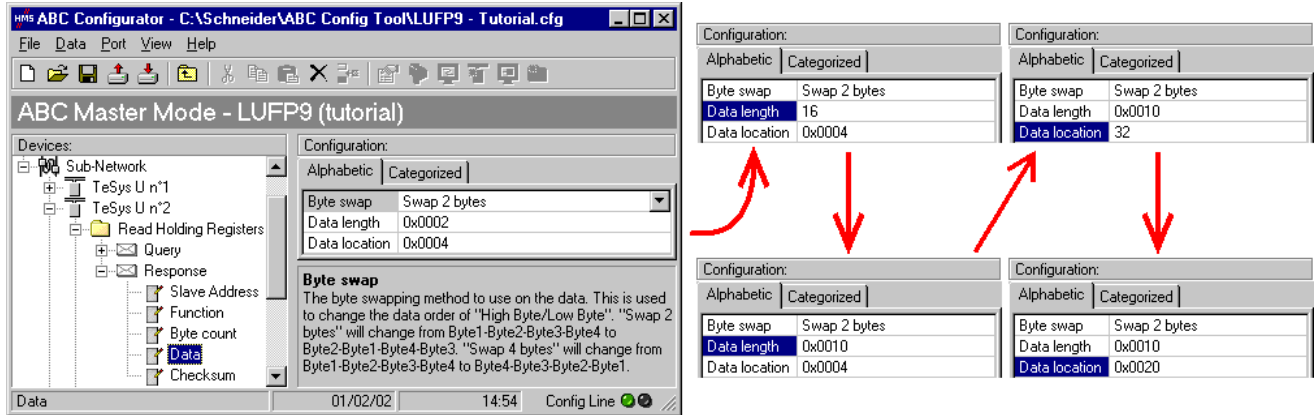

To check that these changes have been entered into the configuration, choose “Monitor” from the “Sub-Network” menu again:

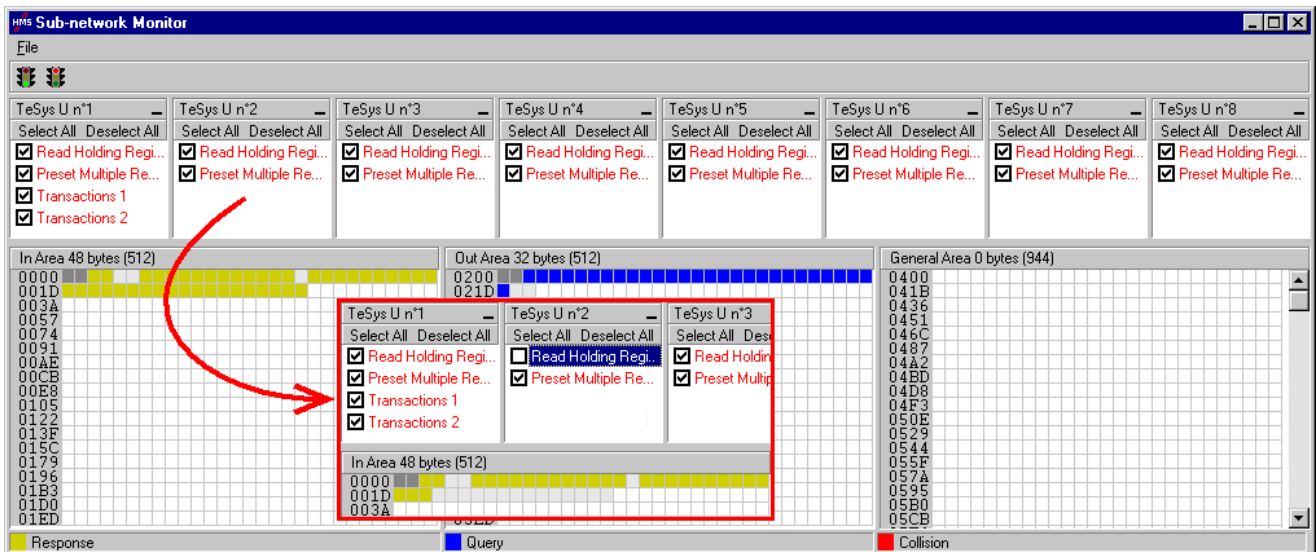

- 4) Transferring this configuration to the gateway Please see chapter 6.4 Transferring a Configuration to the Gateway. Check that the configuration is valid (LED  DEVICE STATUS flashing green).
- 5) Saving this configuration to your PC's hard disk.
- 6) Checking the gateway setup: In RSNetWorx, check the values of the gateway parameters (see chapter 4.2.4 Editing Gateway Parameters). Only the value of parameter no. 7, “Input1 length”, should have changed, from “32 bytes” to “48 bytes”.

NOTE: You shall make sure the values of the displayed parameters are the same as the exchange sizes displayed in the “Sub-network Monitor.” In the current example, “In Area 48 bytes” implies that the “Input1” area begins at offset 0 (physical address 0x0000) and that its length is equal to 48 bytes. Also, “Out Area 32 bytes” implies that the “Output1” area begins at offset 0 (physical address 0x0200) and that its length is equal to 32 bytes.

6. Configuring the Gateway

- 7) Changing the amount of data received by the DeviceNet scanner: Still in RSNetWorx, change the value for the amount of periodic data received by the DeviceNet scanner (see chapter 4.2.5 Configuring the DeviceNet Scanner). Change the value of the “Rx Size:” field from 32 to 48, in the “Polled:” section.
- 8) Configuring the DeviceNet master PLC inputs: In RSNetWorx, establish a new correspondence between the data from the gateway and the PLC inputs, according to the requirements of your application (see chapter 4.2.6 Configuring Inputs from the Gateway). The various possibilities offered by RSNetWorx for establishing a correspondence between the data from a DeviceNet subscriber and the PLC inputs will not be covered here. Please see the documentation for this software application to find out more about this step in setting up a DeviceNet master PLC.

In this guide, we will be using the “AutoMap” command to establish a “raw” correspondence with all of the data from the LUFP9 gateway. We then get the correspondence shown below, derived from the one used with the gateway’s default configuration. The changes in relation to the default configuration are shown by a greyed-out background, like the “free memory locations”.

Service	PLC input	Description	
		Bit 0 Bit 7	Bit 8 Bit 15
Managing the downstream Modbus network	I:1.1	LUFP9 gateway status word (MSB → 0xxx••)	(LSB → 0x••xx)
Periodic communications — Monitoring of TeSys U motor starters	I:1.2	Value of the motor starter ① status register	
	I:1.3	Free memory location	
	I:1.4	Value of the motor starter ③ status register	
	I:1.5	Value of the motor starter ④ status register	
	I:1.6	Value of the motor starter ⑤ status register	
	I:1.7	Value of the motor starter ⑥ status register	
	I:1.8	Value of the motor starter ⑦ status register	
Aperiodic communications — Reading the value of a motor starter parameter (RESPONSE)	I:1.9	Value of the motor starter ⑧ status register	
	I:1.10	Free memory location	Slave no. (0x01-0x08)
Aperiodic communications — Writing the value of a motor starter parameter (RESPONSE)	I:1.11	Function number (0x03)	Number of bytes read (0x02)
	I:1.12	Value of the parameter read (MSB → 0xxx••) (LSB → 0x••xx)	
Aperiodic communications — Writing the value of a motor starter parameter (RESPONSE)	I:1.13	Slave no. (0x01-0x08)	Function no. (0x06)
	I:1.14	Address of the parameter written (MSB → 0xxx••) (LSB → 0x••xx)	
	I:1.15	Value of the parameter written (MSB → 0xxx••) (LSB → 0x••xx)	
Aperiodic communications (“Trigger bytes” for the responses)	I:1.16	Read parameter response counter	Write parameter response counter
Periodic communications — Monitoring of TeSys U motor starter ②	I:1.17	Value of the “TeSys U Status Register”	
	I:1.18	Value of the “Complementary Status Register”	
	I:1.19	Value of the “K7 Status Register”	
	I:1.20	Value of the “K7 Status Register 2 (free format)”	
	I:1.21	Value of the “K7 Status Register 3 (free format)”	
	I:1.22	Value of the “Warning Number” register	
	I:1.23	Value of the “Warning Register”	
I:1.24	Value of “Reserved : 2 nd Warning Register”		

6. Configuring the Gateway

- 9) Transferring the DeviceNet scanner configuration: Following the changes made to the list of DeviceNet scanner exchanges, it needs to be transferred to the DeviceNet scanner. Please see chapter 4.2.8 Transferring the DeviceNet Scanner Configuration.

6.8.4. Increasing the amount of periodic output data

We will use the node corresponding to “TeSys U no. 4” motor starter for our example. By default, we are controlling Command Register 704. To add control of Command Register 705, we will carry out the following operations.

- 1) Changing the number of registers controlled: This step consists of changing the value of the “No. of Registers” in the “Query” and in the “Response” for the “Preset Multiple Registers” command (Modbus command for writing values of a number of registers). Start by selecting “N° of Registers” from the “Query”, then change its value as shown below. ABC-LUFP Config Tool will automatically convert any value entered in decimal to hexadecimal. Do the same for the “N° of Registers” element of the “Response” because the gateway checks the value of this field when it receives each Modbus response. If the value does not correspond to that of the query, the gateway will ignore the response.

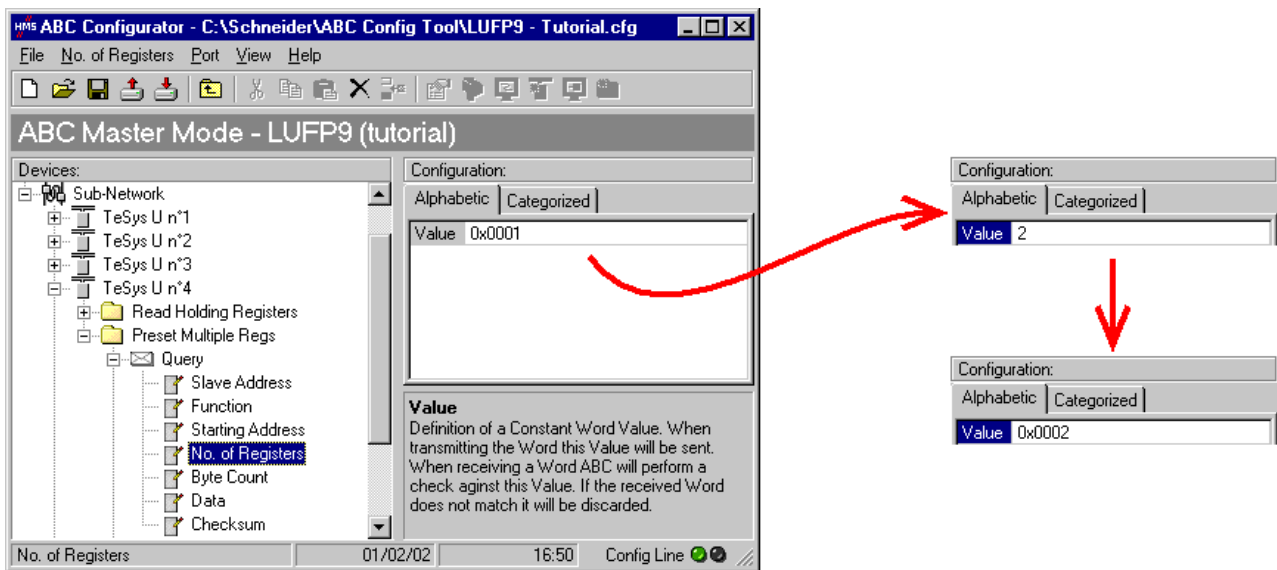

6. Configuring the Gateway

- 2) Changing the number of data bytes in the Modbus query: The number of bytes written into the memory of the “TeSys U n°4” motor starter memory increases from 2 to 4, as the number of registers controlled has increased from 1 to 2. Select the “Byte count” element from the “Query” and change its value as shown below. ABC-LUFP Config Tool will automatically convert any value entered in decimal to hexadecimal.

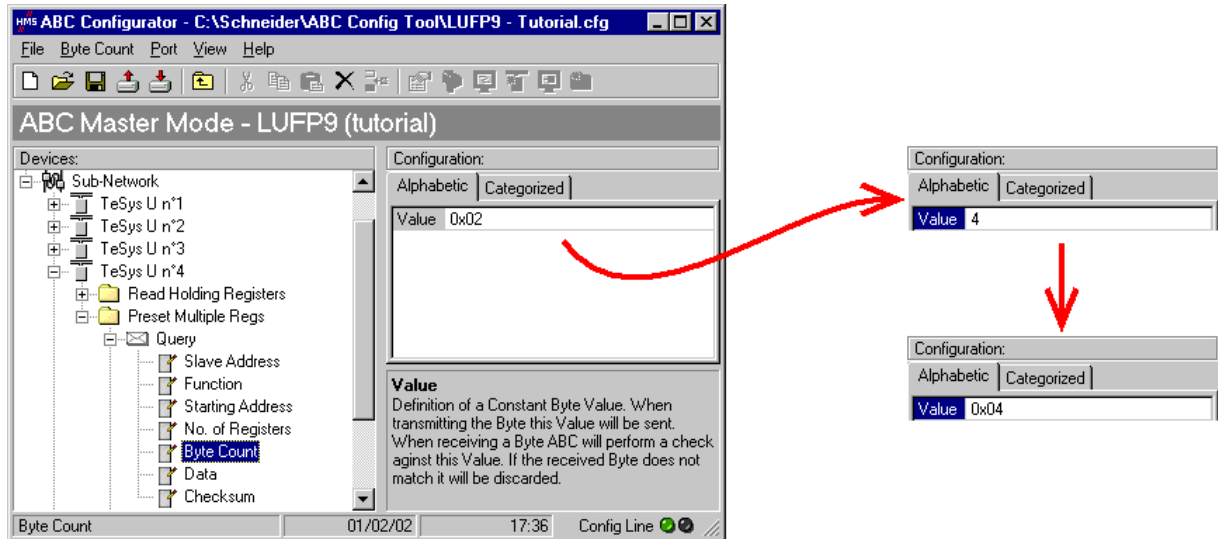

- 3) Changing the location of the Modbus data transmitted into the gateway’s memory: As the number of bytes written (see previous step) has increased from 2 to 4, the Modbus data to be transmitted to the “TeSys U n°4” motor starter must be placed at a different location in the gateway’s memory, and the size of the memory occupied must also be adjusted appropriately.

If you are not certain how much of the gateway’s memory is currently occupied, select “Sub-Network” and choose “Monitor” from the “Sub-Network” menu. The window shown below appears, allowing you to see how much of the gateway’s memory is occupied.

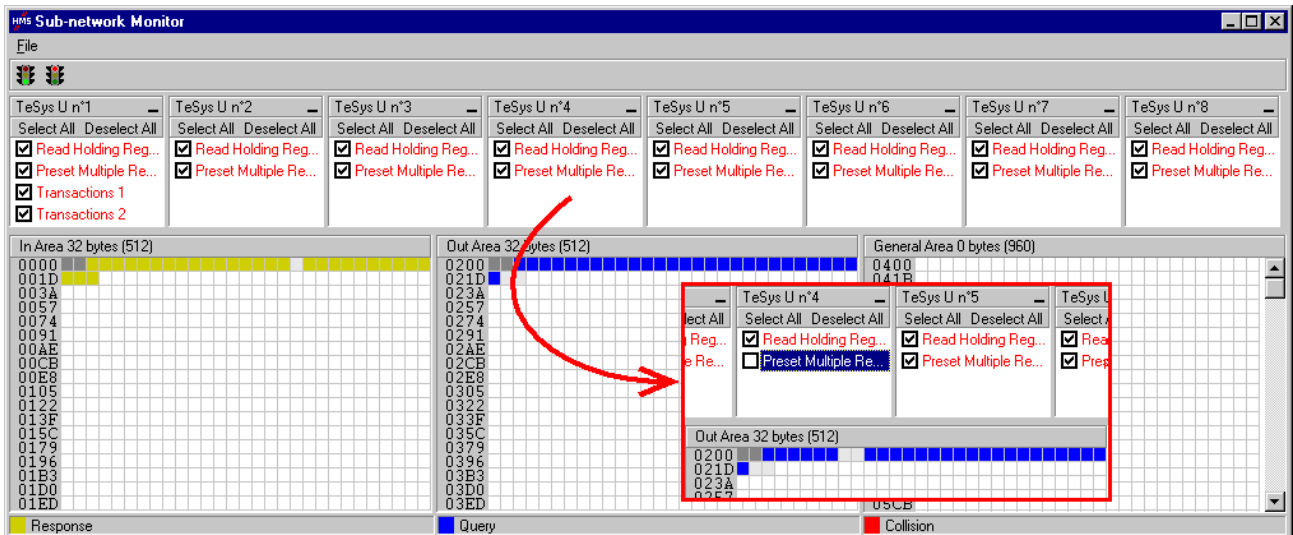

6. Configuring the Gateway

To see which memory locations are occupied by data from the command you are interested in, all you have to do is uncheck the box corresponding to the “Preset Multiple Registers” command from the “TeSys U n°4” node, as shown above. We can see that the Modbus data transmitted with the query corresponding to this command occupy 2 bytes located from address 0x0208.

NOTE: Memory locations 0x0200 and 0x0201 are reserved (see chapter 5 Gateway Initialization and Diagnostics). So you will not be able to place any Modbus data in these locations. The sizes displayed above the graphics areas of this window (“In Area 32 bytes” and “Out Area 32 bytes”) correspond to the total input and output sizes you must check under RSNetWorx (see point 6 on next page) and configure for the DeviceNet scanner (see point 7).

If you wish to place the 4 bytes of Modbus data which will be transmitted by the gateway for this command into memory, once the changes have been made, we will have to move all the other output data by 2 bytes, which may be tedious, or change the memory location of the block of data transmitted. In the example described here, we will be using the second solution, although the first solution is actually preferable, in principle, as it avoids leaving any “holes” in the gateway’s memory, thus optimising the transfer of all of the data from the DeviceNet master PLC. Furthermore, the 1747-SDN scanner can only exchange 32 output words with the master PLC. Leaving “holes” of this sort in the gateway’s memory is therefore not recommended in cases of large configurations.

When selecting a value for the “Data Location” field, data must be located at even addresses in order to align the Modbus data (in 16-bit format) on the O:1.x outputs of the DeviceNet scanner. If data is not located at even addresses, the values intended for the Modbus registers may be spread over two DeviceNet PLC words. This greatly complicates programming of the application, as the application may need to parse one PLC word for the Modbus LSB byte, and another for the Modbus MSB byte. If this complication is not handled properly, it is possible to read and write the wrong data values to the Modbus slaves

WARNING

RISK OF UNINTENDED EQUIPMENT OPERATION

The user must use even values for the “Data Location” field. The selection of odd data values complicates application programming and increases the likelihood of improper Modbus values being written to or read from the slave devices. Depending on the user’s configuration, unintended equipment operation may result.

Failure to follow this instruction may result in death, serious injury, or equipment damage.

Returning to our previous example, the value to be assigned to the ATS48’s CMD register should be placed in the gateway’s output data memory area. We will be using the first free location starting at an even address, that is to say the one located at 16#0220, with the gateway’s default configuration.

We will place the 4 bytes of data from address 0x0220 (544 in decimal).

6. Configuring the Gateway

Close the “Sub-network Monitor” window, then once you are back in the main ABC-LUFP Config Tool window, select the “Data length” and “Data location” fields of the “Data” element from the “Query” one after another and change their values as shown at the top of the next page. ABC-LUFP Config Tool will automatically convert any value entered in decimal to hexadecimal.

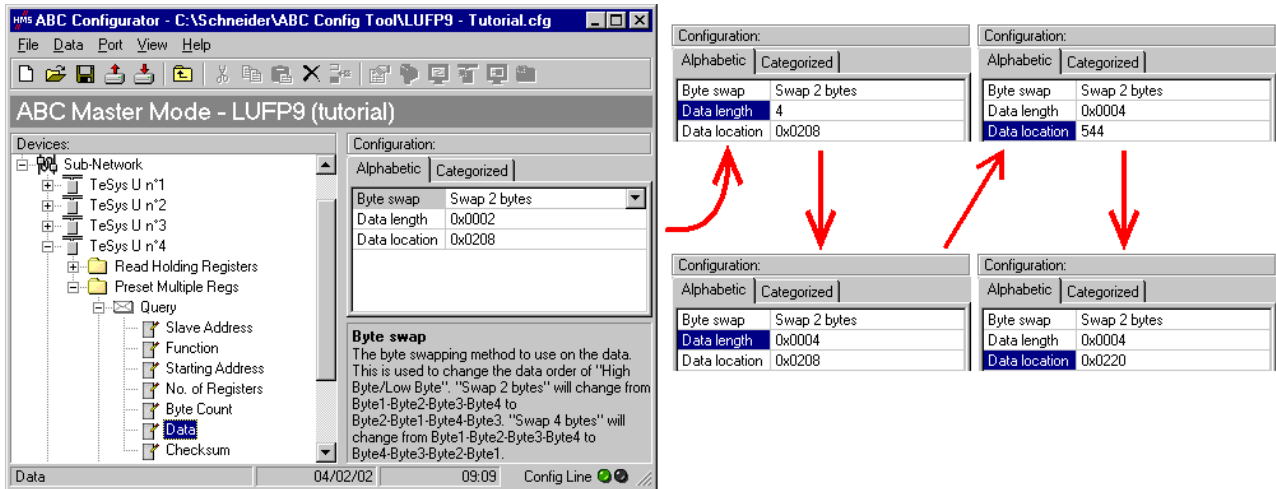

To check that these changes have been entered into the configuration, choose “Monitor” from the “Sub-network” menu again:

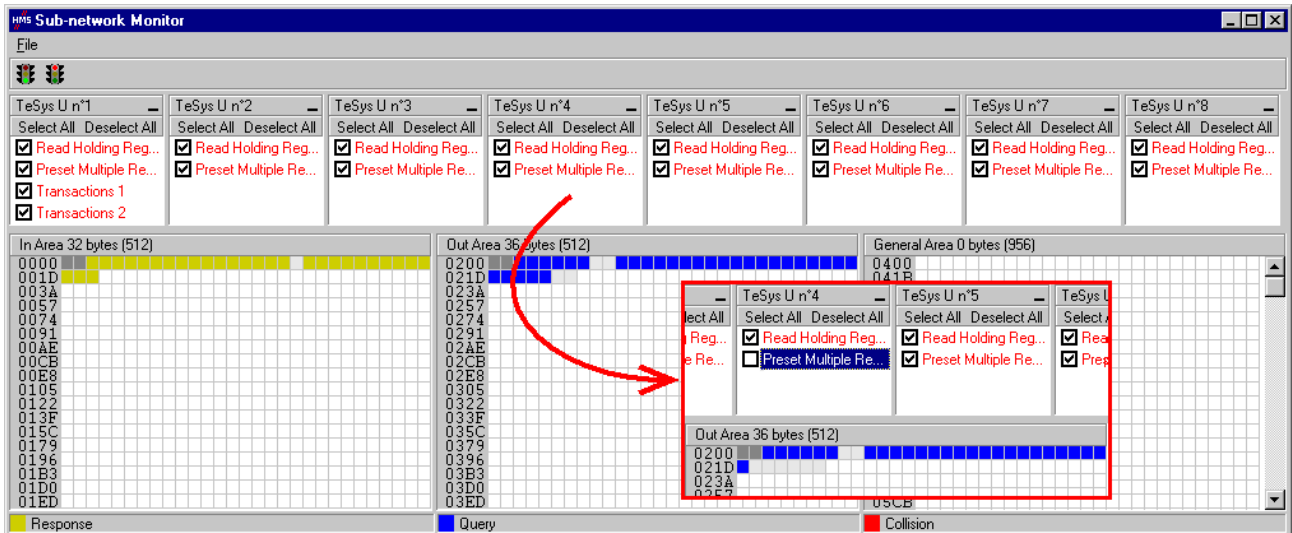

- 4) Transferring this configuration to the gateway Please see chapter 6.4 Transferring a Configuration to the Gateway. Check that the configuration is valid (LED ⑥ DEVICE STATUS flashing green).
- 5) Saving this configuration to your PC's hard disk.
- 6) Checking the gateway setup: In RSNetWorx, check the values of the gateway parameters (see chapter 4.2.4 Editing Gateway Parameters). Only the value of parameter no. 19, “Output1 length”, should have changed, from “32 bytes” to “36 bytes”.

NOTE: You shall make sure the values of the displayed parameters are the same as the exchange sizes displayed in the “Sub-network Monitor.” In the current example, “In Area 32 bytes” imply that the “Input1” area begins at offset 0 (physical address 0x0000) and that its length is equal to 32 bytes. Also, “Out Area 36 bytes” imply that the “Output1” area begins at offset 0 (physical address 0x0200) and that its length is equal to 36 bytes.

6. Configuring the Gateway

- 7) Changing the amount of data transmitted by the DeviceNet scanner: Still in RSNetWorx, change the value for the amount of periodic data transmitted by the DeviceNet scanner (see chapter 4.2.5 Configuring the DeviceNet Scanner). Change the value of the “Tx Size:” field from 32 to 36, in the “Polled:” section.
- 8) Configuring the DeviceNet master PLC outputs: In RSNetWorx, establish a new correspondence between the data transmitted to the gateway and the PLC outputs, according to the requirements of your application (see chapter 4.2.7 Configuring Outputs Intended for the Gateway). The various possibilities offered by RSNetWorx for establishing a correspondence between the data transmitted to a DeviceNet subscriber and the PLC outputs will not be covered here. Please see the documentation for this software application to find out more about this step in setting up a DeviceNet master PLC.

In this guide, we will be using the “AutoMap” command to establish a “raw” correspondence with all of the data transmitted to the LUFF9 gateway. We then get the correspondence shown below, derived from the one used with the gateway’s default configuration. The changes in relation to the default configuration are shown by a greyed-out background, like the “free memory locations”.

Service	PLC output	Description	
		Bit 0 Bit 7	Bit 8 Bit 15
Managing the downstream Modbus network	O:1.1	DeviceNet master command word (MSB → 0xxx••)	(LSB → 0x••xx)
Periodic communications — Controlling TeSys U motor starters	O:1.2	Value of the motor starter ① command register	
	O:1.3	Value of the motor starter ② command register	
	O:1.4	Value of the motor starter ③ command register	
	O:1.5	Free memory location	
	O:1.6	Value of the motor starter ⑤ command register	
	O:1.7	Value of the motor starter ⑥ command register	
	O:1.8	Value of the motor starter ⑦ command register	
	O:1.9	Value of the motor starter ⑧ command register	
Aperiodic communications — Reading the value of a motor starter parameter (QUERY)	O:1.10	Slave no. (0x01-0x08)	Function no. (0x03)
	O:1.11	Address of the parameter to be read (MSB → 0xxx••)	(LSB → 0x••xx)
	O:1.12	Number of parameters to be read (MSB → 0x00••)	(LSB → 0x••01)
Aperiodic communications — Writing the value of a motor starter parameter (QUERY)	O:1.13	Slave no. (0x01-0x08)	Function no. (0x06)
	O:1.14	Address of the parameter to be written (MSB → 0xxx••)	(LSB → 0x••xx)
	O:1.15	Value of the parameter to be written (MSB → 0xxx••)	(LSB → 0x••xx)
Aperiodic communications (“Trigger bytes” for the queries)	O:1.16	Read parameter query counter	Write parameter query counter
Periodic communications Monitoring of TeSys U motor starter ④	O:1.17	Value of the “Command Register”	
	O:1.18	Value of the “2nd Command Register”	

- 9) Transferring the DeviceNet scanner configuration: Following the changes made to the list of DeviceNet scanner exchanges, it needs to be transferred to the DeviceNet scanner. Please see chapter 4.2.8 Transferring the DeviceNet Scanner Configuration.

6. Configuring the Gateway

6.9. Deleting Aperiodic Parameter Data

If your PLC application does not need the aperiodic service for reading/writing parameter data on Modbus slaves, you can delete the associated commands. If you also intend to add Modbus data, and therefore use new locations in the gateway's memory, it is preferable to delete the aperiodic commands from the start, so that you can reuse the memory locations.

On the other hand, if the only configuration operation you wish to carry out on the LUFP9 gateway consists of not using the aperiodic service for parameter data, you can simply not use this service in RSNetWorx. Go straight on to step 8.

If you decide to delete the aperiodic commands, you will need to carry out the following operations:

- 1) Displaying parameter data commands: Select the very first node of the downstream Modbus network, "TeSys U n°1", and expand the tree structure showing its commands and transactions. The screen should look like the one below:

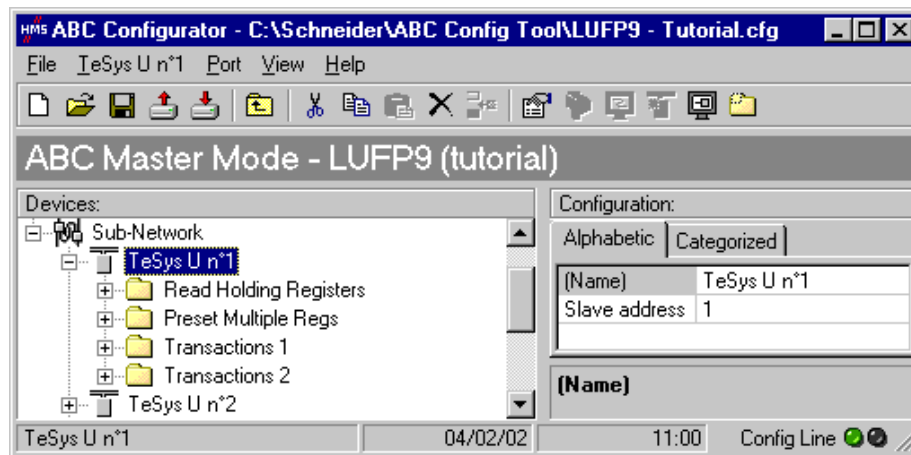

- 2) Deleting the read command for a parameter: Select the personalized "Transactions 1" command and delete it with the "De~~l~~" key (or "Delete" from the menu whose name corresponds to the name of the selected node). A request for confirmation appears, asking you whether or not to proceed deleting the "Transactions 1" command. In this case confirm with the "Yes" button.

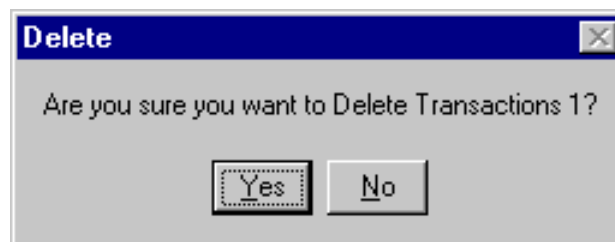

- 3) Deleting the write command for a parameter: Back in the main ABC-LUFP Config Tool window, the "Transactions 1" command has been deleted. The second personalised command, "Transactions 2" is automatically renamed "Transactions 1", but retains all of its setup. Now delete this one in the same way as you did with the previous command. When this is done, there is no consequence for the other nodes.

6. Configuring the Gateway

- 4) Checking the new memory occupation: If you wish to check how much of the gateway's memory is now occupied, select "Sub-Network" and choose "Monitor" from the "Sub-Network" menu. The following window appears, allowing you to see how much of the gateway's memory is occupied by Modbus data. The part framed in red represents the memory occupation before the deletion of the two setup commands. It has been inlaid in the illustration below so that you can see the effects of the deletion operations we have just carried out.

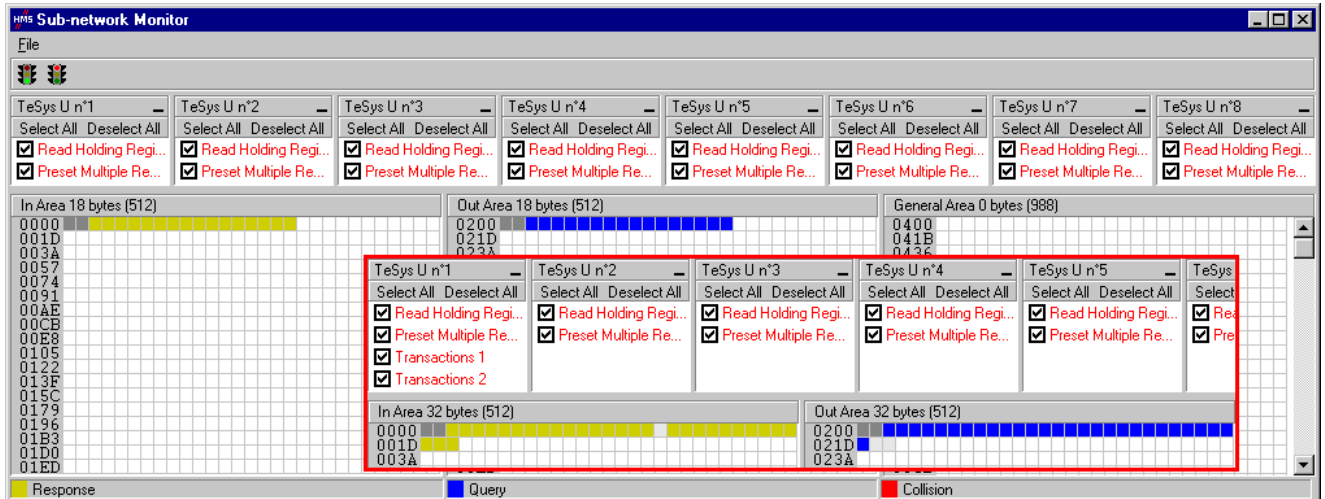

You will Note: that the "TeSys U n°1" section now only has the two Modbus commands common to the eight TeSys U motor starters, and that the memory locations which corresponded to the two personalised commands are now free.

NOTE: The free memory location at address 0x0012 in the gateway's memory is no longer part of the gateway's inputs, because there is no input data used beyond this address.

- 5) Transferring this configuration to the gateway Please see chapter 6.4 Transferring a Configuration to the Gateway. Check that the configuration is valid (LED 6 DEVICE STATUS flashing green).
- 6) Saving this configuration to your PC's hard disk.
- 7) Checking the gateway setup: In RSNetWorx, check the values of the gateway parameters (see chapter 4.2.4 Editing Gateway Parameters). The value of parameter no. 7, "Input1 length", should have changed, from "32 bytes" to "18 bytes". The value of parameter no. 19, "Output1 length", should have changed, from "32 bytes" to "18 bytes".
- 8) Changing the amount of data received and the amount of data transmitted by the DeviceNet scanner: Still in RSNetWorx, change the value for the amount of periodic data received and the amount of periodic data transmitted by the DeviceNet scanner (see chapter 4.2.5 Configuring the DeviceNet Scanner). In the "Polled:" section, change the value of the "Rx Size:" field from 32 to 18 and the value of the "Tx Size:" field from 32 to 18.
- 9) Configuring the DeviceNet master PLC inputs and outputs: In RSNetWorx, establish a new correspondence between the data from the gateway and the PLC inputs (see chapter 4.2.6 Configuring Inputs from the Gateway). Do the same for the correspondence between the data transmitted to the gateway and the PLC outputs (see chapter 4.2.7 Configuring Outputs Intended for the Gateway).

We then get the two correspondences shown on the next page, derived from those used with the gateway's default configuration.

6. Configuring the Gateway

Service	PLC input	Description			
		Bit 0	Bit 7	Bit 8	Bit 15
Managing the downstream Modbus network	I:1.1	LUF9 gateway status word (MSB → 0xxx••) (LSB → 0x••xx)			
Periodic communications — Monitoring of TeSys U motor starters	I:1.2	Value of the motor starter ① status register			
	I:1.3	Value of the motor starter ② status register			
	I:1.4	Value of the motor starter ③ status register			
	I:1.5	Value of the motor starter ④ status register			
	I:1.6	Value of the motor starter ⑤ status register			
	I:1.7	Value of the motor starter ⑥ status register			
	I:1.8	Value of the motor starter ⑦ status register			
	I:1.9	Value of the motor starter ⑧ status register			

Service	PLC output	Description			
		Bit 0	Bit 7	Bit 8	Bit 15
Managing the downstream Modbus network	O:1.1	DeviceNet master command word (MSB → 0xxx••) (LSB → 0x••xx)			
Periodic communications — Controlling TeSys U motor starters	O:1.2	Value of the motor starter ① command register			
	O:1.3	Value of the motor starter ② command register			
	O:1.4	Value of the motor starter ③ command register			
	O:1.5	Value of the motor starter ④ command register			
	O:1.6	Value of the motor starter ⑤ command register			
	O:1.7	Value of the motor starter ⑥ command register			
	O:1.8	Value of the motor starter ⑦ command register			
	O:1.9	Value of the motor starter ⑧ command register			

- 10) Transferring the DeviceNet scanner configuration: Following the changes made to the list of DeviceNet scanner exchanges, it needs to be transferred to the DeviceNet scanner. Please see chapter 4.2.8 Transferring the DeviceNet Scanner Configuration.

6.10. Changing a Modbus slave Configuration

Configuring a Modbus slave itself remains very simple because it only involves the name and the Modbus address of the node to which it corresponds. On the contrary, configuring Modbus commands is much more complicated and is the subject of a separate section (see chapter 6.11 Adding and Setting Up a Modbus Command).

You will need to change the configuration of a Modbus slave when you add a new Modbus unit (see chapter 6.7 Adding a Modbus Slave).

Changing the name of the node which corresponds to a Modbus slave is used to distinguish it from the other nodes when the configuration of its Modbus commands has been changed.

6. Configuring the Gateway

6.10.1. Changing the Name of a Modbus Slave

To carry out this operation, all you have to do is select the node which corresponds to the Modbus slave involved (“Devices:” section), click on the current name (value of the “(Name)” field, in the “Configuration:” section), then change it. After confirming the new name (“Enter” key or click outside the name’s data entry field), this will become effective in ABC-LUFP Config Tool, and the name of the node will be automatically updated in the “Devices:” section. An example is given at the top of the next page. The three red frames shown in this example show the sequence of the changes made.

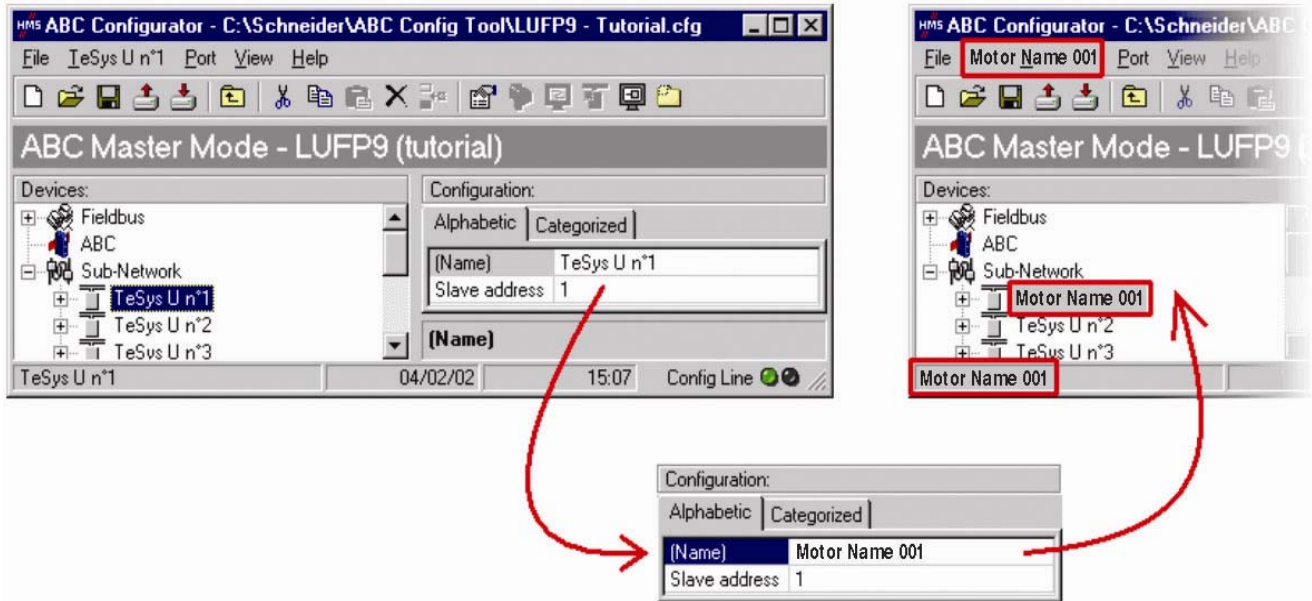

6.10.2. Changing the Address of a Modbus Slave

To carry out this operation, all you have to do is select the node which corresponds to the Modbus slave involved (“Devices:” section), click on the value of the current address (value of the “Slave address” field, in the “Configuration:” section), then change it.

Reminder: The address of a Modbus slave must be between 1 and 247. The system will not let you add a value > 247.

⚠ WARNING

USE OF RESERVED MODBUS ADDRESSES

Do not use Modbus addresses 65, 126, or 127 if a gateway’s Modbus slaves will include a Schneider Electric Speed Variation device such as an Altistart soft-starter or an Altivar motor drive. The Altistart and Altivar devices reserve these addresses for other communications, and the use of these addresses in such a system can have unintended consequences.

Failure to follow this instruction may result in death, serious injury, or equipment damage.

6. Configuring the Gateway

After confirming the new address (“Enter” key or click outside the data entry field of the address of the Modbus slave), this will become effective in ABC-LUFP Config Tool, and the values of the “Slave Address” elements of the queries and responses in the Modbus commands for the selected node will be automatically updated. An example is given below, with the update of a single “Slave Address” element:

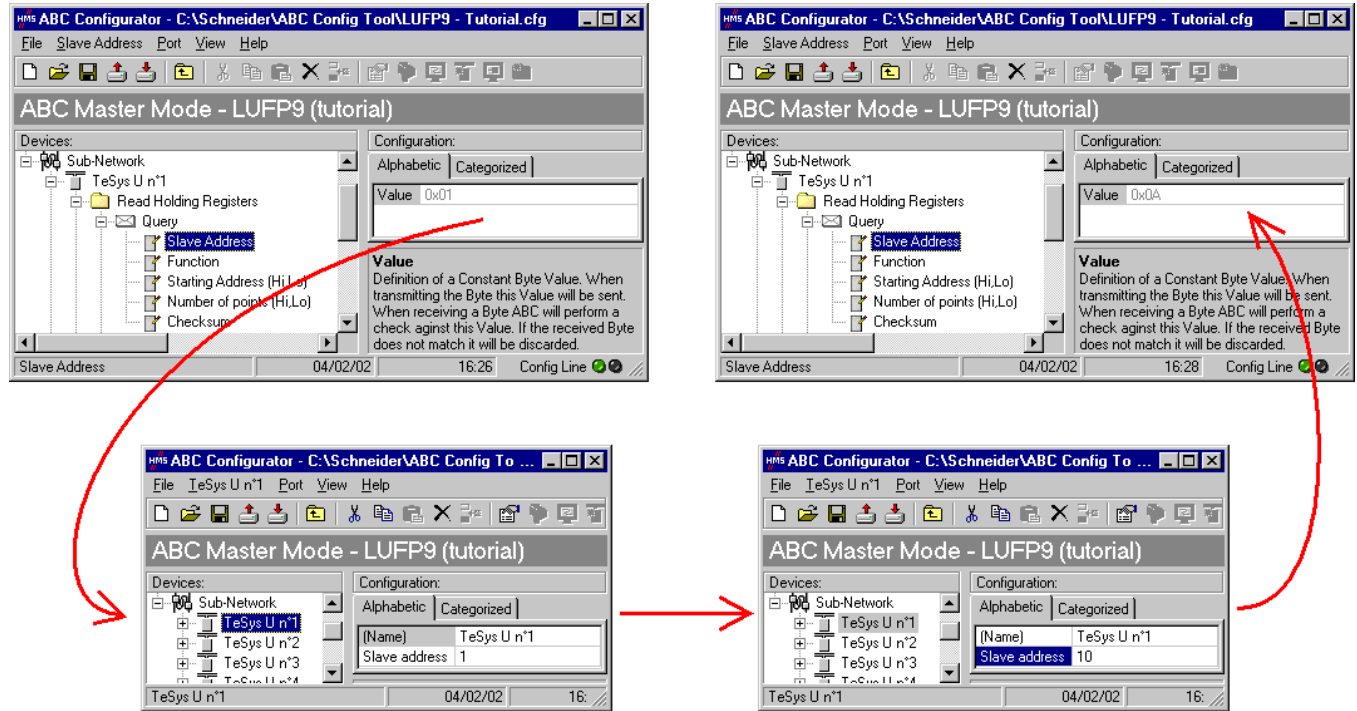

6.11. Adding and Setting Up a Modbus Command

6.11.1. With TeSys U Motor Starters

With TeSys U motor starters, adding a Modbus command allows you to control or monitor additional registers, without having to change the default configuration. So, the operation of the periodic and aperiodic communication services remains the same as for the default configuration, unlike the operations described in chapter 6.8 Changing Periodic Data Exchanged With a Modbus Slave.

Instead of adding a command and fully configuring it, it is a better idea to copy one of the two default commands “Read Holding Registers” or “Preset Multiple Registers” from an existing node, and to paste it into the list of Modbus commands for the appropriate node.

To copy an already configured Modbus command from an existing node, select it, then choose “Copy” from the menu whose name corresponds to the name of the selected node. **Keyboard shortcut:** “Ctrl C”. Then continue using one of the two methods shown below:

- Select the node corresponding to the Modbus slave for which you wish to add this command (e.g. “TeSys U n°4”), then choose “Paste” from the menu whose name corresponds to the selected node. A new command is added after all the other configured commands for this node. The whole of its configuration is identical to that for the previously copied command. **Keyboard shortcut:** “Ctrl V”.
- Select one of the commands for the node involved, then choose “Insert” from the menu whose name corresponds to the selected command. A new command is added just before the one which is selected. The whole of its configuration is identical to that for the previously copied command.

6. Configuring the Gateway

As the new Modbus command and the original Modbus command are identical, you will need to make changes to the fields **highlighted in blue** in one of the two following diagrams, depending on whether this is the “Preset Multiple Registers” command or a “Read Holding Registers” command (see chapter 6.8 Changing Periodic Data Exchanged With a Modbus Slave). The correspondence between the various elements which appear in these tree structures and the standard Modbus terminology is located to their right:

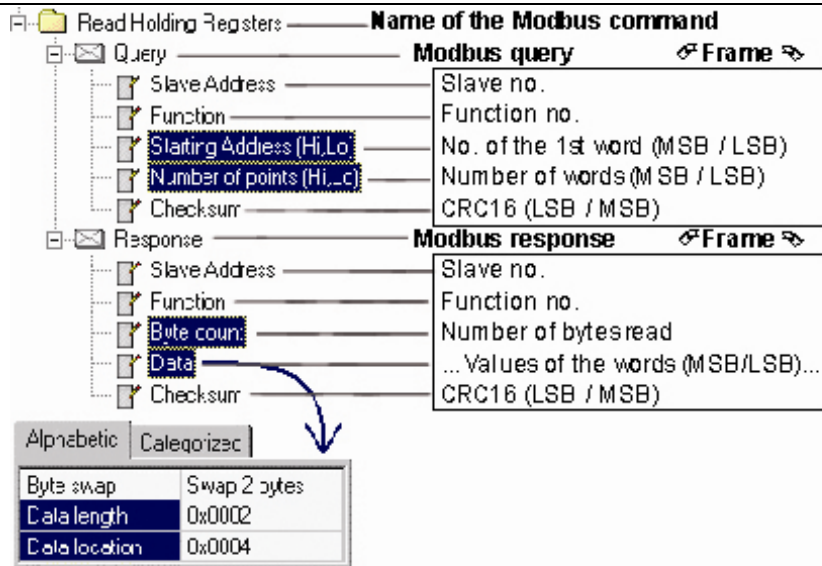
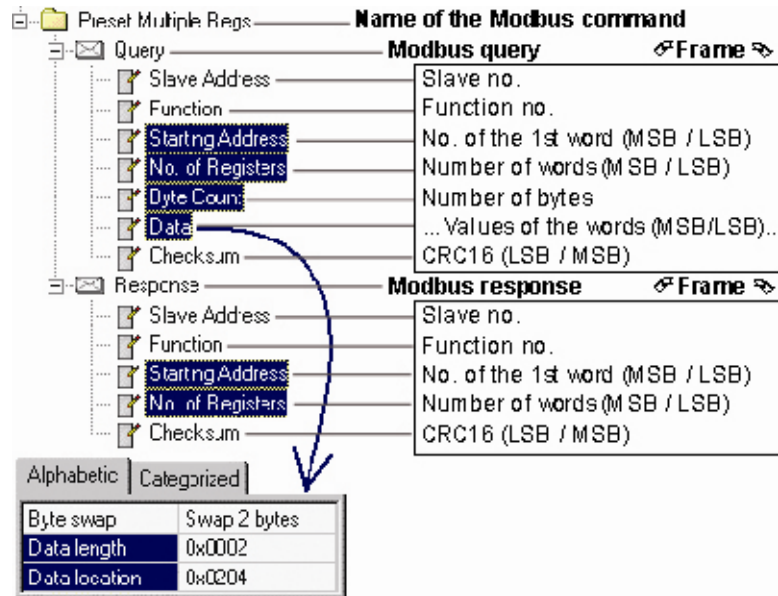

NOTE: In all cases, the “Query / Slave Address” and “Response / Slave Address” elements are automatically updated by ABC-LUFP Config Tool according to the node in which the command is located. Their values cannot be changed by the user. In the same way, the “Query / Function” and “Response / Function” fields depend on the nature of the Modbus command and cannot be changed by the user.

6. Configuring the Gateway

The operations to be carried out are more or less the same as those consisting of changing the default commands. For the “Read Holding Registers” command, please see chapter 6.8.1 Replacing a Periodic Input Data Element, and chapter 6.8.3 Increasing the Amount of Periodic Input Data. For the “Preset Multiple Registers” command, please see chapter 6.8.2 Replacing a Periodic Output Data Element, and chapter 6.8.4 Increasing the amount of periodic output data.

6.11.2. With a Generic Modbus Slave

In this chapter, we will add and configure Modbus commands differing from the LUF9 defaults.

Please see Appendix E: Modbus Commands, for a list of the Modbus functions supported by the LUF9 gateway. If you need to use a command which is not supported by the gateway, you can configure one. A command of this sort is included in a specific element called “Transactions” or becomes a new Modbus command in its own right. Please see the next paragraph for further details on this subject.

For our example, we will use an Altistart starter, the ATS48, and a Modbus command recognized both by the gateway and the ATS48. This is the “Preset Single Register” command, whose function code is 6 and which allows you to write the value of a unique output word. This function will be used to periodically write the value of the ATS48’s CMD command register, located at address W400 (address 400 = 0x0190).

Since the gateway’s default configuration already has 8 Modbus slaves, you will need to delete one of them, such as the “TeSys U n°2” node, for example, and to add a new node in its place (see chapter 6.6 Deleting a Modbus Slave, and chapter 6.7 Adding a Modbus Slave).

Reminder: We strongly advise you not to delete the “TeSys U n°1” node, as it contains the commands corresponding to the read and write services for a parameter in a Modbus slave.

6. Configuring the Gateway

After creating the new node, we rename it and assign it Modbus address 10, as shown at right:

We then add the “Preset Single Register” command by choosing “Add Command” from the “ATS48” menu.

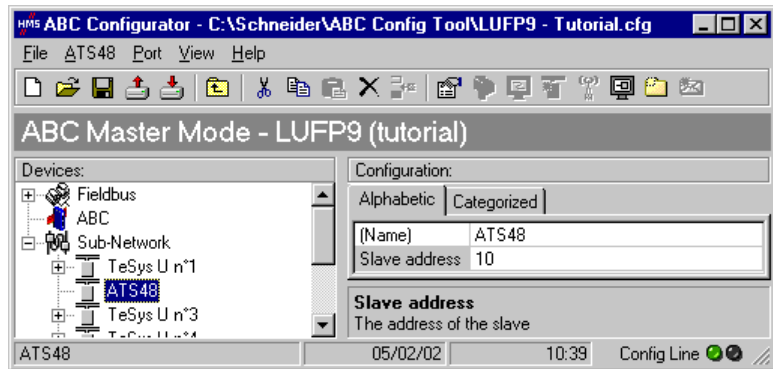

In the window which appears (shown opposite), select the “0x06 Preset Single Register” command and choose “Select” from the “File” menu.

Back in the main ABC-LUFF Config Tool window, the “Preset Single Register” command now appears in the list of Modbus commands for the “ATS48” node.

Expand the full tree structure for this command, as shown below. The correspondence between the various elements which appear in this tree structure and the standard Modbus terminology is located to its right.

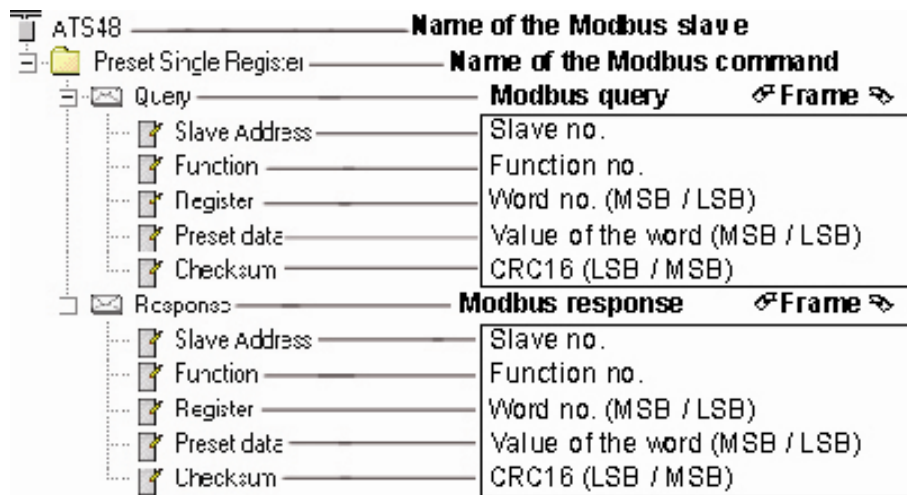

These elements can be configured using ABC-LUFF Config Tool, as described in the following chapters.

6. Configuring the Gateway

6.11.2.1. Managing Degraded Modes

PLC processor stopped or on failure

PLC processor response
Outputs: Software error, outputs reset to default state or hold their present state depending on configuration. Hardware error (EEPROM or hardware failure), output state will be indetermined Inputs: PLC stops responding to inputs in any error state.
DeviceNet scanner response
Depending on scanner configuration: the scanner stops to communicate with the LUFP9 gateway, or forces DeviceNet outputs to 0 and refreshes the inputs, or holds DeviceNet outputs in their last position, and refreshes the inputs.
LUFP9 gateway response
If the scanner stops to communicate with the gateway, the behavior depends on the fieldbus "Offline options: Clear: All data sent to the concerned Modbus slave is set to 0. Freeze: All data sent retains its current value. No scanning: The query is no longer transmitted.
If the scanner forces DeviceNet outputs to 0 and refreshes the inputs: all data sent (Write requests) is set to 0, reading from slaves continues to run normally.
If the scanner holds DeviceNet outputs and refreshes the inputs: all data sent (Write requests) retains its current value, reading from slaves continues to run normally.
Slave response
Depending of the slave.

DeviceNet scanner stopped or on failure

PLC processor response
The PLC processor provides some error and/or diagnostic objects to the application in case of DeviceNet scanner stop or failure (input/output not valid). Refer to the PLC user manual to have their description. This information must be managed in the PLC application.
DeviceNet scanner response
If the DeviceNet scanner is stopped (command coming from the application): the scanner stops to communicate with the LUFP9 gateway.
If the DeviceNet scanner is on failure: the scanner stops to communicate with the processor and the LUFP9 gateway.
LUFP9 gateway response
If the scanner stops to communicate with the gateway, the behavior depends on the fieldbus "Offline options: Clear: All data sent to the concerned Modbus slave is set to 0. Freeze: All data sent retains its current value. No scanning: The query is no longer transmitted.

6. Configuring the Gateway

Slave response

Depending on the slave.

LUF99 gateways disconnected on DeviceNet side

PLC response

The PLC processor provides some error and diagnostic objects coming from the DeviceNet scanner in case of a slave disconnection from the application. Refer to the PLC user manual to have their description. This information must be managed in the PLC application.
--

DeviceNet scanner response

The DeviceNet scanner provides the processor with some error and diagnostic objects in case of DeviceNet slave disconnection.

LUF99 gateway response

The behavior depends on the fieldbus Offline options: Clear : All data sent to the concerned Modbus slave is set to 0. Freeze : All data sent retains its current value. No scanning : The query is no longer transmitted.

Slave response

Depending of the slave

LUF99 gateways failure

PLC response

The PLC processor provides some error and diagnostic objects coming from the DeviceNet scanner in case of slave failure to the application. Refer to the PLC user manual to have their description. This information must be managed in the PLC application.
--

DeviceNet scanner response

The DeviceNet scanner provides the processor with some error and diagnostic objects in case of DeviceNet slave failure.

LUF99 gateway response

In case of a failure, the gateway stops to communicate with the DeviceNet scanner and the Modbus slaves.
--

Slave response

Depending on the slave.

6. Configuring the Gateway

LUFP9 gateways disconnected on Modbus side or slave failure

PLC response
The processor gives access to the gateway status word coming from the DeviceNet scanner input table and to the gateway command word coming from the output table. These 2 words must be managed in the PLC application in order to detect if a Modbus slave is missing.
DeviceNet scanner response
The DeviceNet scanner must be configured to access the gateway status and command words in order to provide Modbus diagnostic information.
LUFP9 gateway response
The behavior depends on the different options: Timeout time, number of Retries, Reconnect time and Offline option for sub-network.
Slave response
In case of a Modbus disconnection, the behavior depends on the slave.
In case of a slave failure, undetermined state which must be managed in the PLC application.

6. Configuring the Gateway

6.11.2.2. Configuring the Query

Select the “Query” element from the Modbus command. The various elements of the configuration of the query for this command are shown opposite. The values displayed correspond to the default values for any new command.

These elements allow you to configure how the whole command is managed, including how degraded modes are managed (number of re-transmissions, for example).

Alphabetic	Categorized
Offline options for fieldbus	Clear
Reconnect time (10ms)	1000
Retries	3
Timeout time (10ms)	100
Trigger byte address	0x05FF
Update mode	Cyclically
Update time (10ms)	100

Each of these elements is described, in order, in the table below. When a unit is assigned to an element, it is shown in brackets after the name of the element:

Configuration element	Description
Offline options for fieldbus	<p>This element affects the data sent to the Modbus slave, but only in the query to which this element belongs to, whenever the gateway is disconnected from the DeviceNet network. This element takes one of the following three values:</p> <ul style="list-style-type: none"> - ClearFrom now on all data sent to the Modbus slave using this query is set to 0x0000 (resetting of the output data in the gateway’s memory). - FreezeAll data sent to the Modbus slave using this query retains its current values (the output data in the gateway’s memory is frozen). - NoScanning...The query is no longer transmitted to the Modbus slave by the gateway.
Reconnect time (10ms) Default value: 10ms x 1000 = 10s	<p>If there is no response from the Modbus slave to a query, or following the receipt of an incorrect response, the gateway uses the “Retries” and “Timeout time (10ms)” elements to carry out re-transmissions. If the Modbus slave has still not responded correctly following these re-transmissions, the gateway stops sending it the corresponding query for a period of time which can be adjusted using “Reconnect time (10ms)”.</p> <p>When this “Reconnect time” has elapsed, the gateway attempts to restore communication with the Modbus slave.</p>
Retries Default value: 3	<p>This element indicates the number of re-transmissions carried out by the gateway if there is no response from the Modbus slave to a query, or if the response is incorrect. This re-transmission process ceases as soon as the gateway gets a correct response within a given time. If none of the re-transmissions has allowed the gateway to obtain a correct response, the Modbus slave is deemed to be off-line, but only in relation to the command in question. The gateway then uses the “Offline options for sub-network” and “Reconnect time (10ms)” elements and the LED  Modbus becomes red. This LED will only revert to a green state if the Modbus command is answered with a correct response, once the reconnection has started (see element “Reconnect time (10ms)”).</p> <p>If the number of re-transmissions is set to 0, the process described above will not be run.</p>
Timeout time (10ms) Default value: 10ms x 100 = 1s	<p>This element represents the time that the gateway will wait for a response. If a response has not reached the gateway within the given time, configured using the “timeout time (10ms)” element, the gateway proceeds to a re-transmission. This process continues until it reaches the last re-transmission allowed (see “Retries”), then the gateway declares the Modbus slave off-line, but only for the command to which the “timeout time (10ms)” belongs.</p>

6. Configuring the Gateway

Configuration element	Description
Trigger byte address	<p>This element is only used by the gateway if “Update mode” is set to “Change of state on trigger”. In this case, it specifies the address, in the gateway’s output memory (0x0202 to 0x03FF), of an 8-bit counter managed by the DeviceNet master.</p> <p>When the DeviceNet master updates the value at the Trigger Byte Address to any value other than zero, the query configured with an Update Mode of a “Change of state on trigger” is transmitted to the Modbus slave. So the DeviceNet master must have access to this counter in the same way as for the periodic output registers sent to TeSys U motor starters.</p> <p>In comparison to the “On data change” Update Mode, this mode allows you to send a command on a specific order from the DeviceNet master if, for example, the latter is unable to update all data of any given query at the same time.</p> <p>NOTE: In the specific case of the gateway’s default configuration, the “Transactions 1” and “Transactions 2” personalized command modes for the “TeSys U n°1” node are set to “Change of state on trigger”. These aperiodic commands are respectively used to read and write the value of a parameter for one of the Modbus slaves.</p> <p>The “Trigger byte address” elements of the “Query” elements for these two commands are configured at addresses 0x021E and 0x021F. These are the “parameter read/write request counters”. Considered under DeviceNet and RSNNetWorx, these two data are configured the same way as the other outputs (see chapter 4.2.4 Editing Gateway Parameters) and both correspond to the O:1.16 output.</p> <p>To transmit one of these two commands, the DeviceNet master PLC must first update all of the data to be transmitted on the Modbus network for this command (addresses 0x0212 to 0x0217 or addresses 0x0218 to 0x021D), then change the value of the associated counter (address 0x021E or 0x021F). The gateway will then transmit the query corresponding to the command.</p> <p>NOTE: The “trigger byte” does not have to be an item of output data updated by the DeviceNet master. In fact it is quite possible that it may be an input between 0x0002 and 0x01FF. In this case, the Modbus slave which updates this byte will condition the exchanges of the command you’re currently configuring.</p>
Update mode	<p>This element is used to specify the transmission mode for the query on the Modbus network. It takes one of the following four values:</p> <ul style="list-style-type: none"> - Cyclically..... Default communication mode. The query is transmitted periodically on the Modbus network (see “Update time”). - On data change..... The gateway transmits the query on the Modbus network when at least one item of data from this query is changed by the DeviceNet master. So this is an aperiodic communication mode. - Single Shot..... This transmission mode only allows a single Modbus exchange for the whole of the time that the gateway is operating. This exchange takes place just after the initialization of the gateway. - Change of state on trigger..... With this aperiodic communication mode, the Modbus query is sent every time that the DeviceNet master changes the value of an 8-bit counter designated by the “Trigger byte address” element. For instance, this is the case with the queries associated with “Transactions 1” and “Transactions 2” personalized commands for the “TeSys U n°1” node of the gateway’s default configuration. These queries are transmitted when the values of the related “trigger bytes” (addresses 0x021E and 0x021F) are changed by the DeviceNet master. Please see the description of this element for further information about how to use this communication mode.

6. Configuring the Gateway

Configuration element	Description
Update time (10ms) Default value: 10ms x 100 = 1s	This element is only used by the gateway if "Update mode" is set to "Cyclically". In this case, it specifies the query's transmission period on the Modbus network.

Returning to our example employing the ATS48 at address 10, we will use the configuration shown opposite. The most notable points of this configuration are:

- On disconnection the data is reset on both networks.
- 3 re-transmissions with a 100 ms timeout.
- Periodic communications with a cyclical Update time set to 300 ms.

Alphabetic	Categorized
Offline options for fieldbus	Clear
Reconnect time (10ms)	1000
Retries	3
Timeout time (10ms)	10
Trigger byte address	0x05FF
Update mode	Cyclically
Update time (10ms)	30

6. Configuring the Gateway

6.11.2.3. Configuring the Response

Next select the “Response” element from the Modbus command. The various elements of the configuration of the response for this command are shown opposite. The values displayed correspond to the default values for any new command.

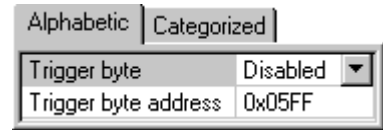

These elements allow you to configure a single aspect of managing the command, described at the top of the page on the right. Each of these elements is described, in order, in the table below.

Configuration element	Description
Trigger byte	<p>This element is used by the gateway to activate the unitary incrementation of an 8-bit counter in order to notify the DeviceNet master of the receipt of a new response to the associated Modbus command. It takes one of the following two values:</p> <ul style="list-style-type: none"> - Disabled..... Default configuration. The gateway does not increment any counter on receipt of the Modbus response. - Enabled Each time that the gateway receives a new response to the associated Modbus command, it increments the value of an 8-bit counter designated by the “Trigger byte address” element (see below). This change in the value of the Trigger Byte Address can be used to notify the DeviceNet master that Modbus Response data is ready to be polled.
Trigger byte address	<p>This element is only used by the gateway if the element “Trigger byte” is set to “Enabled”. In this case, it specifies the address, in the gateway’s input memory (0x0002 to 0x01FF), of an 8-bit counter managed by the gateway.</p> <p>When the gateway receives a response to the associated Modbus command, it increments the value of this counter in a unitary manner (value = value+1). So the DeviceNet master must have access to this counter in the same way as for the periodic input registers from the TeSys U motor starters.</p> <p>This mode allows the DeviceNet master to be informed that a new response is available. This can be useful, for example, if it is possible that the data from two consecutive responses may be identical.</p> <p>NOTE: In the specific case of the gateway’s default configuration, the “Trigger byte” element for responses to the “Transactions 1” and “Transactions 2” personalized commands of the “TeSys U n°1” node is set to “Enabled”. Hence, the management of responses to read and write commands for parameters is event driven.</p> <p>The “Trigger byte address” elements of the “Response” elements for these two commands are configured at addresses 0x001E and 0x001F. These are the “parameter read/write response counters”. Considered under DeviceNet and RSNetWorx, these two data are configured the same way as the other inputs (see chapter 4.2.6 Configuring Inputs from the Gateway) and both correspond to the I:1.16 input.</p> <p>The DeviceNet master PLC will be able to detect the receipt of a response from a Modbus slave by comparing the previous value and the current value of the associated counter (address 0x001E or 0x001F). If there is a <i>unitary incrementation</i> of this counter, the PLC may, for example, read all of the data from the response (addresses 0x0013 to 0x0017 or addresses 0x0018 to 0x001D) and allow the transmission of a new query for reading or writing the value of a parameter (using a “Trigger byte” for the queries). In contrast to other “Query” counters, the value stored at the “Response” Trigger byte Address is a true modulo 256 counter, <i>i.e.</i> zero must be managed (... 254, 255, 0, 1, 2 ...).</p>

In this example using the ATS48, we do not want the response to be event driven. So we will be retaining the default configuration.

6. Configuring the Gateway

6.11.2.4. Configuring the Content of the Query Frame

The window shown below is obtained using “Edit Frame” from the “Query” menu. Unlike the tree structure in the main ABC-LUFP Config Tool window, this display has the advantage of showing all of the frame’s fields at the same time as well as their values. The values displayed below correspond to the values assigned by default to the Modbus command query we have created. The correspondence with the content of the corresponding Modbus frame has been added underneath this window.

HM5 Frame Editor							
File							
Slave Address	Function	Register	Preset data			Checksum	
Value	Value	Value	Data location	Data length	Byte swap	Error check type	Error check start byte
0x0A	0x06	0x0000	0x0002	0x0000	No swapping	CRC	0x0000
Slave no.	Function no.	Word number (MSB / LSB)	Value of the word (MSB / LSB)			CRC16 (LSB / MSB)	

Edit the values which are not greyed out, one after another. There is a description of them below.

The nature of a frame’s fields depends on the Modbus command to which it corresponds. However, a certain number of these fields are common to all frames, whereas others are common to a number of them. Here is a description of those shown above, for the example described at the beginning of the chapter 6.11.2:

Field in the frame	Size in the frame	Description
Slave Address	1 byte	This field cannot be changed by the user and its value is greyed out to inform him of the fact. ABC-LUFP Config Tool updates the value of this field automatically using the address of the Modbus slave corresponding to the current node. NOTE: This field is common to queries for all Modbus commands. E.g. the value of this field is set to the address of the Modbus slave which corresponds to the “ATS48” nodes, that is to say 0x0A.
Function	1 byte	This field cannot be changed by the user and its value is greyed out to inform him of the fact. ABC-LUFP Config Tool updates the value of this field automatically using the function code for the corresponding Modbus command. NOTE: This field is common to queries for all Modbus commands. E.g. the value of this field is set to the code for the “Preset Single Register” command (writing the value of an output word), that is to say 0x06.
Register	2 bytes	Address of an output word, or of a register, in the Modbus slave’s memory. So this field designates the memory object to which the command relates. NOTE: This field is common to queries for all Modbus commands whose purpose is to access one or more locations in the memory of a Modbus slave. When accessing several memory locations, the “Register” field designates the address of the first word affected by the command. E.g. the value of this field should be changed by entering the address of the CMD command register, that is to say 400 (0x0190). This value will be automatically converted to hexadecimal if the user enters it in decimal.

6. Configuring the Gateway

Field in the frame	Size in the frame	Description
Preset Data	2 bytes or more for a block of data	<p><u>Data Location</u>: Address, in the gateway's output data memory (0x0202 to 0x03FF), of the item of data to be transmitted in the "Preset Data" field for the query's frame.</p> <p>NOTE: The "Data location" field is used for each frame that allows you to exchange some data between the Modbus slaves and the DeviceNet master. In this case it designates the starting address of the block of data to be transmitted.</p> <p>When selecting a value for the "Data Location" field, data must be located at even addresses in order to align the Modbus data (in 16-bit format) on the O:1.x outputs of the DeviceNet scanner. If data is not located at even addresses, the values intended for the Modbus registers may be spread over two DeviceNet PLC words. This greatly complicates programming of the application, as the application may need to parse one PLC word for the Modbus LSB byte, and another for the Modbus MSB byte. If this complication is not handled properly, it is possible to read and write the wrong data values to the Modbus slaves.</p>

WARNING

RISK OF UNINTENDED EQUIPMENT OPERATION

The user must use even values for the "Data Location" field. The selection of odd data values complicates application programming and increases the likelihood of improper Modbus values being written to or read from the slave devices. Depending on the user's configuration, unintended equipment operation may result.

Failure to follow this instruction may result in death, serious injury, or equipment damage.

		<p>Returning to our previous example, the value to be assigned to the ATS48's CMD register should be placed in the gateway's output data memory area. We will be using the first free location starting at an even address, that is to say the one located at 0x0220, with the gateway's default configuration.</p>
		<p><u>Data length</u>: Length of the block of output data, in the gateway's memory, whose values must be transmitted in the "Preset Data" field of the query's frame. It is expressed in number of bytes.</p> <p>NOTE: The "Data length" field is always used together with the "Data location" field, described above.</p> <p>E.g. since the "Preset Single Register" command is used to write the value of a single register (16-bit), the value of the "Data length" field must be set to 2.</p> <p>See the documentation for each Modbus slave to find out the maximum amount of 8-bit data which can be placed in "Data" type fields in queries and responses for this slave. With the ATS48, for instance, it is limited to 30 16-bit words (Data length field limited to ≤ 60).</p>

6. Configuring the Gateway

Field in the frame	Size in the frame	Description
		<p><u>Byte swap</u>: Specifies whether the output data bytes to be transmitted to the Modbus slave must be swapped before being placed in the Modbus frame or not. The three possible values are as follows:</p> <ul style="list-style-type: none"> - No swapping Default configuration. The data is sent in the same order as they appear in the gateway's memory. - Swap 2 bytes The bytes to be transmitted are swapped two by two. For an item of 16-bit data, the most significant byte is placed first in the Modbus frame, whereas it is always written into the gateway's memory by a DeviceNet master with the least significant byte first. - Swap 4 bytes The bytes to be transmitted are swapped four by four. This is rarely used, as it only relates to 32-bit data. The principle is similar to that of the previous case, "Swap 2 bytes". <p>NOTE: With DeviceNet, use "Swap 2 bytes".</p> <p>For example, we will be using the "Swap 2 bytes" value because the two bytes of the value to be written into the ATS48's CMD register, as transmitted by the SLC500 PLC, are placed into the gateway's memory in least significant / most significant order.</p>
Checksum	2 bytes	<p><u>Error check type</u>: Type of error check for the frame.</p> <ul style="list-style-type: none"> - CRC Default method. <p>This is the method adopted for the Modbus RTU protocol. It cannot be changed.</p> <p><u>Error check start byte</u>: Indicates the number of the byte, in the frame, from which the calculation of the "checksum" should begin. The first byte in each frame carries the number 0.</p> <p>NOTE: The calculation of a frame's checksum should always begin with the first byte. Do not change the error check start byte from its default of zero. A non-zero value will result in an incorrect CRC, and all Modbus communications will return an error.</p>

6. Configuring the Gateway

6.11.2.5. Configuring the Content of the Response Frame

The window shown below is obtained using “Edit Frame” from the “Response” menu. The values shown in it correspond to the values assigned by default to the Modbus command response we have created. The correspondence with the content of the resulting Modbus frame has been added underneath this window.

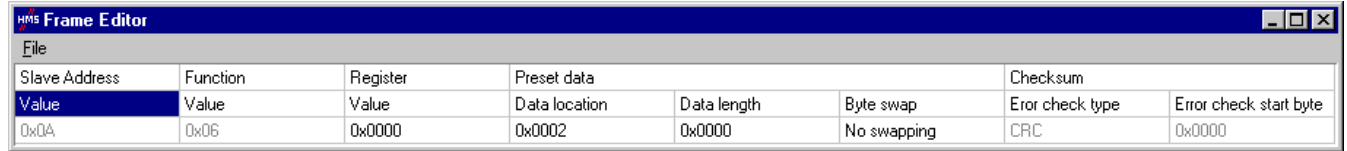

The screenshot shows the HMS Frame Editor window with the following configuration:

Slave Address	Function	Register	Preset data			Checksum	
Value	Value	Value	Data location	Data length	Byte swap	Error check type	Error check start byte
0x0A	0x06	0x0000	0x0002	0x0000	No swapping	CRC	0x0000

Slave no.	Function no.	Word number (MSB / LSB)	Value of the word (MSB / LSB)	CRC16 (LSB / MSB)

Edit the values which are not greyed out, one after another.

There is a description of them on the next page, but also see the previous chapter, as the nature of the content of response frames is very similar to that of the fields in Modbus query frames.

NOTE: If the value of a field from the response of a Modbus slave is different from that configured via ABC-LUFP Config Tool, the response will be rejected by the gateway. It will then proceed to a re-transmission of the query, provided that at least one re-transmission has been configured for this command (see chapter 6.11.2.2 Configuring the Query).

6. Configuring the Gateway

Field in the frame	Size in the frame	Description
Slave Address	1 byte	Identical to that of the query's "Slave Address" field.
Function	1 byte	Identical to that of the query's "Function" field.
Register	2 bytes	Identical to that of the query's "Register" field, since the Modbus response of any "Preset Single Register" command is an echo to the corresponding query. Here you should also enter the address of the memory object to which the command relates. If receiving an exception code, see (*).
Preset Data	2 bytes or more for a block of data	<u>Data Location</u> : Address, in the gateway's input data memory (0x0002 to 0x01FF), of the item of data received in the "Preset Data" field for the response's frame. NOTE : Check that the data is located at even addresses in order to align the Modbus data (in 16-bit format) on the I:1.x inputs of the DeviceNet scanner. E.g. The value sent back as an echo to the command must be placed in the gateway's input data memory area. We will be using the first free location, that is to say the one located at 0x0020, with the gateway's default configuration. If receiving an exception code, see (*).

WARNING

RISK OF UNINTENDED EQUIPMENT OPERATION

The user must use even values for the "Data Location" field. The selection of odd data values complicates application programming and increases the likelihood of improper Modbus values being written to or read from the slave devices. Depending on the user's configuration, unintended equipment operation may result.

Failure to follow this instruction may result in death, serious injury, or equipment damage.

		<u>Data length</u> : Length of the block of input data received in the "Preset Data" field of the response frame. It is expressed in number of bytes. E.g. The value of the "Data length" field must be set to 2.
		<u>Byte swap</u> : Identical to that of the query's "Byte swap" field (see query's table for details) E.g. We will also be using the "Swap 2 bytes" value, for the same reasons as with the query.
Checksum	2 bytes	Error check type: Identical to that of the query's "Error check type" field. Error check start byte: Identical to that of the query's "Error check start byte" field. NOTE : These two fields cannot be changed by the user and their values are greyed out to reflect this. ABC-LUFP Config Tool updates the values of these fields automatically using those of the query's "Error check type" and "Error check start byte" fields.

(*) If receiving an exception code, the gateway re-transmits the request according to the number of retries that has been defined. Then, it will disconnect the slave.

6. Configuring the Gateway

6.11.3. Adding a Special Modbus Command

Apart from the standard Modbus commands covered in the previous chapter, it is possible to create two types of special Modbus commands: Modbus commands using the same template as standard commands and Modbus commands whose nature and frame content can be completely changed by the user.

6.11.3.1. Modbus Commands Based on Standard Commands

You create a command of this type from the “Select Command” window (see chapter 6.11.2 With a Generic Modbus Slave), by choosing “Add Command” from the “Command” menu. The window shown at the top of the next page appears. It shows the structure of the future command’s query and response frames, which will then be added to the list of available Modbus commands. This structure includes the standard elements, that is to say the “Slave Address”, “Function” and “Checksum” fields, described in previous chapters.

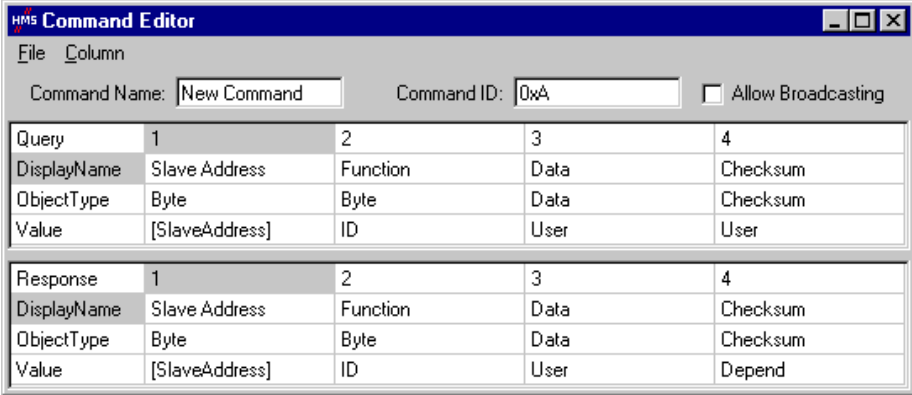

The screenshot shows a window titled "Command Editor" with a menu bar containing "File" and "Column". Below the menu bar, there are two text input fields: "Command Name:" with the value "New Command" and "Command ID:" with the value "0xA". To the right of these fields is a checkbox labeled "Allow Broadcasting" which is currently unchecked.

Below the input fields are two tables. The first table is for the "Query" frame and the second is for the "Response" frame. Each table has four columns labeled 1, 2, 3, and 4.

Query	1	2	3	4
DisplayName	Slave Address	Function	Data	Checksum
ObjectType	Byte	Byte	Data	Checksum
Value	[SlaveAddress]	ID	User	User

Response	1	2	3	4
DisplayName	Slave Address	Function	Data	Checksum
ObjectType	Byte	Byte	Data	Checksum
Value	[SlaveAddress]	ID	User	Depend

Please see chapter 2.12 Command editor in the ABC-LUFP Config Tool user manual, entitled **AnyBus Communicator – User Manual**, for further information about creating standard Modbus commands. This manual can be found on the CD LU9CD1 : “ABC_User_Manual.pdf”.

6. Configuring the Gateway

6.11.3.2. User-Customizable Modbus Commands

In ABC-LUFP Config Tool, these commands are known as “Transactions”. Unlike in the previous examples where many of the variables were fixed by the Modbus command selected, the whole structure of the query and response frames associated with these transactions is dictated by data in the gateway’s memory. These data fields in the gateway’s memory may contain values in Byte, Word or DWord format and a final “Checksum” field. (See *Query’s table for details*)

All of the data contained in the query and response “Data” fields of a “Transactions” command are managed by the DeviceNet master, including the “Slave address” and “Function” fields if these are placed in a “Data” field. For instance, this allows you to manage all of the Modbus frame fields from the DeviceNet master if all of the query and response fields of a “Transactions” element (excluding “Checksum”) are “Data” type fields.

WARNING

MORE THAN ONE “DATA” FIELD IN A MODBUS FRAME

Do not use more than one “Data” field per Modbus frame. Multiple “Data” fields in a single Modbus frame may not be executed in the proper order by the gateway, leading to unintended consequences.

Failure to follow this instruction may result in death, serious injury, or equipment damage.

Constants in Byte, Word or DWord format place the values of these constants in Modbus query frames (constants in “Query” elements) or compare them to the values located in the Modbus responses (constants in “Response” elements). These comparisons are used to accept (identical values) or reject (different values) the Modbus responses in the same way as for standard Modbus commands. The DeviceNet master does not have access to these constants. They are mainly used to replace fields such as “Slave address”, “Function”, “Starting Address,” etc.

Please see the section on “Actions on query/response” in chapter 2.6.4 **Transaction** and in chapter 2.6.6 **Frame objects** in the ABC-LUFP Config Tool user manual, entitled **AnyBus Communicator – User Manual**, for further information about how to handle “Transaction” commands. This manual can be found on the CD LU9CD1: “ABC_User_Manual.pdf”.

The LUFP9 gateway’s default configuration includes two “Transaction” commands. These are aperiodic commands used for reading and writing the value of a Modbus slave parameter (necessarily a TeSys U motor starter with the default configuration). They are configured solely for the “TeSys U n°1” node, as the address of the slave is controlled by the DeviceNet master via the first byte of the “Data” field, which corresponds to the “Slave Address” field in standard Modbus commands. This allows the DeviceNet master to send this command to all of the Modbus slaves, slave by slave, through the first byte of the “Data” field. The remaining fields of the frames used by these two commands are also placed in the same “Data” field. So the DeviceNet master has access to all of the content of the frames in these two commands.

6. Configuring the Gateway

6.12. Configuring the General Characteristics of the Gateway

This operation relates to the gateway's general characteristics ("Fieldbus" to "Sub-Network" elements), whereas the previous chapters described the configuration of the Modbus slaves (elements located under the "Sub-Network" element).

The "Fieldbus" element describes the upstream network, that is to say the DeviceNet network in the case of the LUFP9 gateway.

The "ABC" and "Sub-Network" elements describe the downstream network, that is to say the Modbus RTU network in the case of the LUFP9 gateway, and allow you to identify the software version in the gateway.

The configuration of these three elements, plus the commands they give access to, are described in the next three chapters.

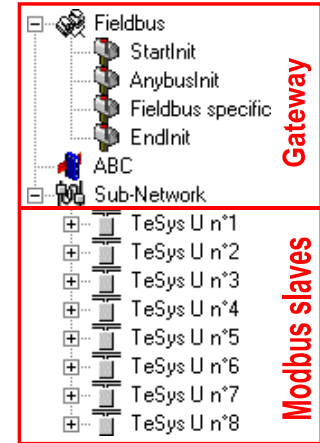

6.12.1. "Fieldbus" Element

Below this element there is a list of the mailboxes configured by default. These elements are not described here, as they are only designed for the internal management of the gateway. These mailboxes can neither be changed nor deleted. Both their number and their nature depend on the type of upstream network.

When the "Fieldbus" element is selected, you can choose the type of upstream network: "DeviceNet" with the LUFP9 gateway.

If the network selected does not match the gateway, an error message will pop-up at loading and the configuration will not be loaded.

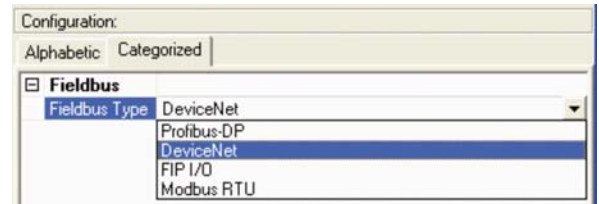

If your PC is connected to the gateway using the PowerSuite cable and you are using ABC-LUFP Config Tool in "on-line" mode when ABC-LUFP Config Tool starts up, the type of upstream network will be automatically detected.

The only command accessible from the "Fieldbus" menu is "About Fieldbus...".

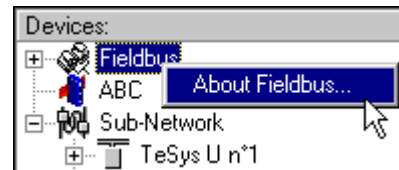

In "on-line" mode, the window shown opposite will be displayed. In "off-line" mode the word "Unknown" will replace "DeviceNet" to show that the type of upstream network cannot be identified.

6. Configuring the Gateway

6.12.2. “ABC” Element

The two commands accessible from the “ABC” menu are “About ABC...” and “Disconnect” (or “Connect” if you are in “off-line” mode).

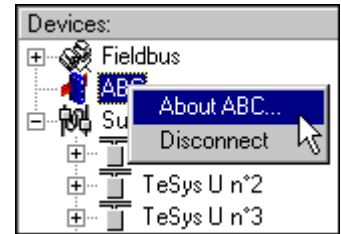
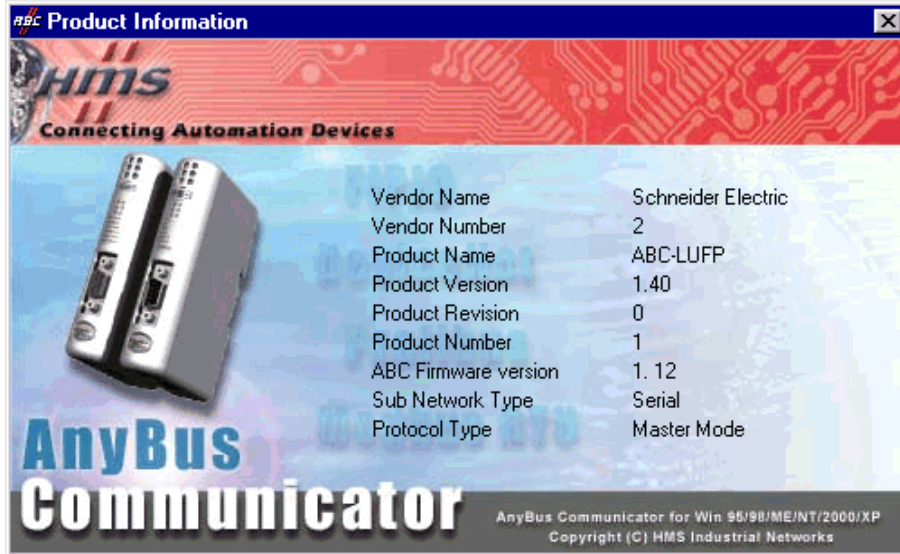

- Running “About ABC...” allows ABC-LUFP Config Tool to upload and display information showing the software version on the PC and the software version in the gateway.

An example is shown opposite.





When you run “About ABC...” in “off-line” mode, the last three fields are replaced by “Unknown” to show that the gateway software version cannot be identified.

NOTE: Only the software version in the gateway’s Modbus card is displayed. This software is common to several types of gateway marketed by *Schneider Electric*. The gateway’s DeviceNet card software version is only accessible using the appropriate DeviceNet object (see Appendix D.; Identity Object).

- The “Disconnect” command allows you to go from “on-line” to “off-line” mode. It is only available in “on-line” mode. It is replaced by “Connect” once you are in “off-line” mode.

Apart from these two exclusive commands, the transition to “on-line” mode is requested by ABC-LUFP Config Tool when certain events do occur (ABC-LUFP Config Tool is launched, use of “Upload” and “Download” commands, etc.).

ABC-LUFP Config Tool’s connection mode is displayed to the right of its status bar:

Config Line			“On-line” mode (the LED on the left is green)
Config Line			“Off-line” mode (the LED on the right is red)

6. Configuring the Gateway

Four options allow you to configure certain of the gateway's system aspects:

- **Control/Status Byte**: The three possibilities available for this option are described in chapter 5 Gateway Initialization and Diagnostics.
- **Module Reset**: By default, this option prevents the gateway from reinitializing itself when there is an internal operation problem. Changing this option is mainly intended for "laboratory" type use.
- **Physical Interface**: The only possibility offered by this option shows that the physical interface of the network downstream of the gateway is a serial link.
- **Protocol**: This option should not be changed, because it indicates the type of protocol used on the downstream network of the gateway. With the LUF9 gateway, "Master Mode" must be selected. The other possibilities available are reserved for other products from the same family as this gateway.

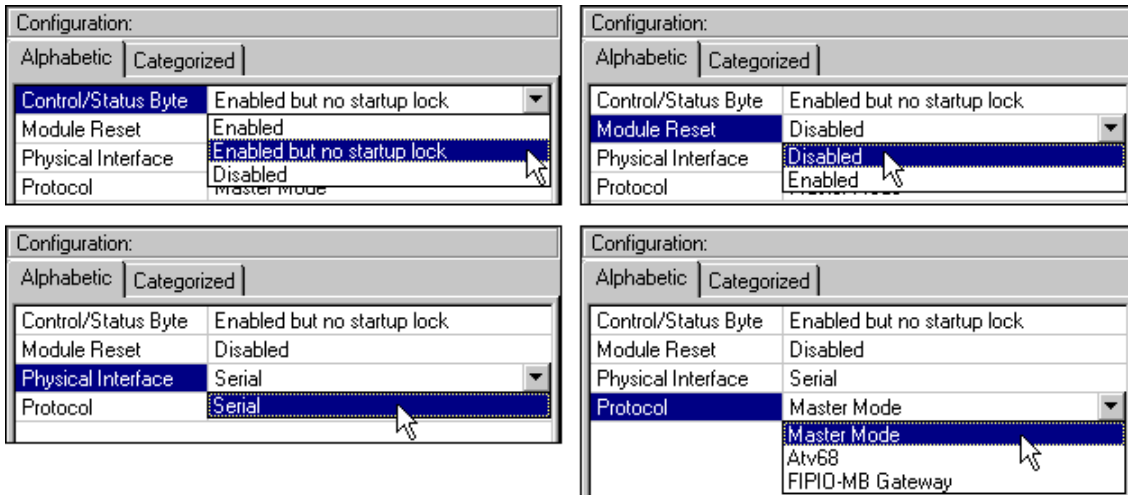

6.12.3. "Sub-Network" Element

The five commands accessible from the "Sub-Network" menu are:

- "**M**onitor": Allows you to view the correspondence between the data from Modbus commands and the content of the gateway's memory. Examples of how to use this command are shown in chapters 6.8.3, 6.8.4 and 6.9.
- "**A**dd **N**ode": Allows you to add a new node on the downstream Modbus network. Each node corresponds to a different Modbus slave. This command is not available if there are already 8 Modbus slaves, which is the case with the gateway's default configuration.
- "**A**dd **B**roadcaster": Allows you to add a broadcaster node (see chapter 6.13 Adding a Broadcaster Node).
- "**L**oad **N**ode": Allows you to add a pre-configured node on the downstream Modbus network. The configuration for this node is contained in an XML file (see the section on "Importing/Exporting a Modbus slave configuration" in chapter 6.7 Adding a Modbus Slave). This command is not available if there are already 8 Modbus slaves, which is the case with the gateway's default configuration.

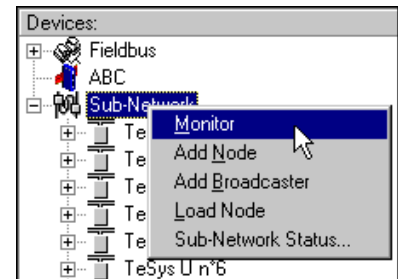

6. Configuring the Gateway

- “Sub-Network Status...”: In “on-line” mode (see chapter 6.12.2 “ABC” Element), this command displays a window summarizing the values of the gateway’s error counters. These counters are also used by the gateway to update the value of its status word (see chapter 5.5 Description of the Gateway Status Word). The “Update” button allows you to refresh the values of these counters.

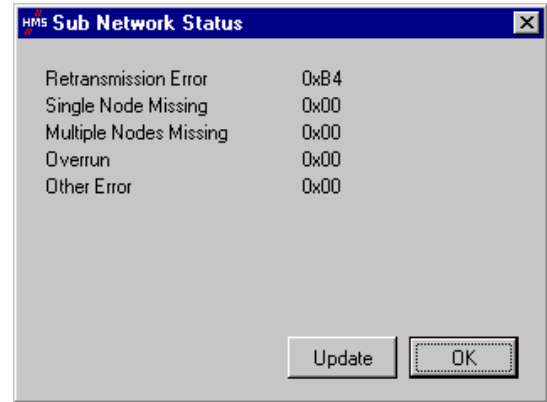

When you run this command in “off-line” mode, all of the values displayed are replaced by the word “Unknown” to show that they cannot be read on the gateway. The “Update” button then becomes inaccessible.

When the “Sub-Network” element is selected, you have access to all of the options allowing you to configure the gateway’s communication protocol format on the Modbus network. The various settings you can make are described below. All of the Modbus slaves present must support this configuration and be configured appropriately.

- Bitrate (bits/s): The gateway supports a limited number of communication speeds. Select the speed that accomodates the slowest slave.
- Data bits: 8 bits (required).
- Message delimiter (10ms): Period of silence added to the normal period of silence between the end of one message and the start of the next message. The normal period of silence corresponds to the time taken to transmit 3.5 characters.
- Parity: Choose the parity according to the format chosen for communications on your Modbus network.
- Physical standard: RS485 (required).
- Start bits: 1 bit (required).
- Stop bits: 1 bit (even or odd parity) or 2 bits.(no parity).

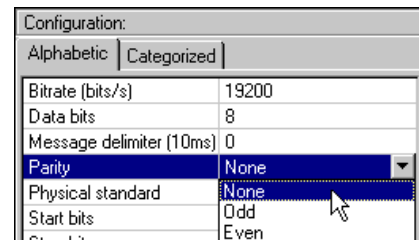
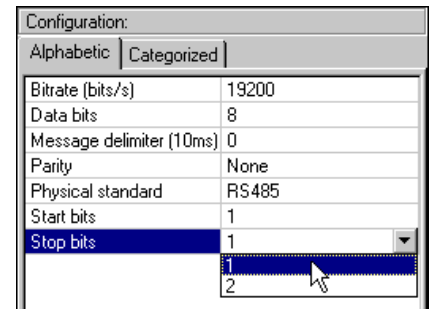
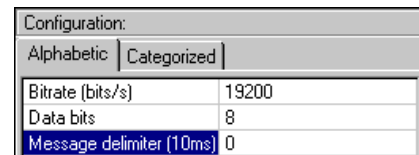
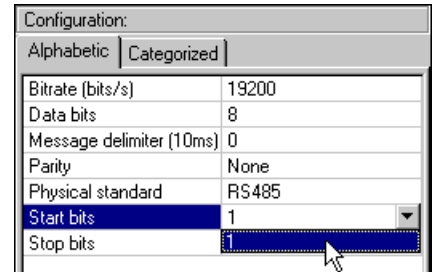
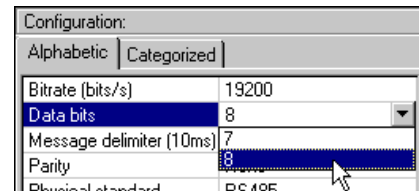
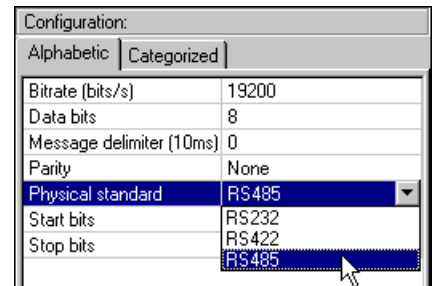
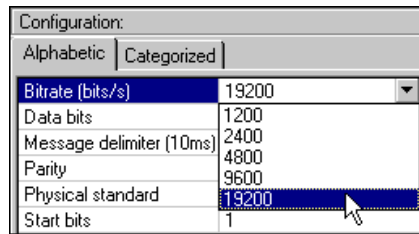

6. Configuring the Gateway

6.13. Adding a Broadcaster Node

A broadcaster node does not correspond to any Modbus slave in particular, as it applies to **all** Modbus slaves. All the commands which will be configured for this node will be transmitted with the “Slave Address” field set to 0x00. This means that all of the slaves will run the command, but that none of them will respond to it.

To add a broadcaster node, select “Sub-Network”, then choose “Add Broadcaster” from the “Sub-Network” menu. The broadcaster node created in this way does not count in the limit on the number of configurable nodes. A simple example is shown opposite:

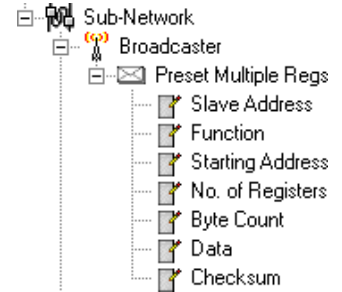

The addition and configuration of a Modbus command in the list of broadcaster node commands is done in the same way as for other nodes, but with the following differences:

- The list of standard Modbus commands which can be used in broadcast is considerably smaller. Only functions 0x06 and 0x10 can be used (see list in chapter 6.11.2).
- The command is made up of a query, but does not include any response. The query bears the name of the command itself, instead of the name “Query”. Also, each broadcast command only consumes one of the 50 queries and responses allowed by the gateway, as there is no possible response for such a command.
- The value of the query frame’s “Slave Address” field is set to 0x00.

Please see chapter 6.11.2.2 Configuring the Query, for further details on how to configure a Modbus query.

Appendix A: Technical Characteristics

Environment

Dimensions (excluding connectors)	Height: 120 mm (4.7 in.)	Width: 27 mm (1.1 in.)	Depth: 75 mm (3.0 in.)
External appearance	Plastic case with device for fixing to a DIN rail.		
Torque	PSU connector: between 5 and 7 lbs.-in (0.56 and 0.79 N-m).		
Power supply	 24V regulated $\pm 10\%$ Maximum consumption: around 95 mA		
Maximum relative humidity	95% without condensation or seepage, according to IEC 68-2-30		
Ambient air temperature around the device, in a dry environment	According to IEC 68-2-1 Ab, IEC 68-2-2 Bb and IEC 68-2-14 Nb: • Storage: $-25^{\circ}\text{C} (\pm 3)$ to $+85^{\circ}\text{C} (\pm 2)$ $(-18.4^{\circ}\text{F to } -7.6^{\circ}\text{F})$... $(+181\text{ F to } 189\text{ F})$ • Operation: $-5^{\circ}\text{C} (\pm 3)$ to $+70^{\circ}\text{C} (\pm 2)$ $(+17.6^{\circ}\text{F to } 28.4^{\circ}\text{F})$... $(+154\text{ F to } 162^{\circ}\text{F})$		
UL	E 214107 certificate "open type" category The product should be installed in an electrical cabinet or in an equivalent location.		
CE	Certified as complying with European standards, unless otherwise stated.		
Electromagnetic compatibility (EMC): Transmission	Complies with the EN 50 081-2:1993 (industrial environment) standard Tested according to class A radiation under the EN 55011:1990 standard		
Electromagnetic compatibility (EMC): Immunity	Complies with the EN 50 082-2:1995 and EN 61 000-6-2:1999 (industrial environment) standard Tested according to the EN 50 204:1995, EN 61000-4-2:1995, EN 61000-4-3:1996, EN 61000-4-4:1995, EN 61000-4-5:1995 and EN 61000-4-6:1996 standards.		

Communication Characteristics

"Upstream" network	DeviceNet										
"Downstream" network	Modbus RTU										
DeviceNet characteristics	<ul style="list-style-type: none"> • Network topology: Multipoint linear topology (bus) with suitable line terminations (impedance of $121\ \Omega \pm 1\% \frac{1}{4}W$). • Physical media: Four types of specific DeviceNet cables, with built-in 24V  PSU: <table style="margin-left: 20px; border: none;"> <tr> <td>① Thick double twisted pair cylindrical cable</td> <td>③ Flat cable</td> </tr> <tr> <td>② Thin double twisted pair cylindrical cable</td> <td>④ "KwikLink" cable</td> </tr> </table> • Communication speed: 125, 250, or 500 kbits/s • Total maximum length of the network: <table style="margin-left: 20px; border: none;"> <tr> <td>500 m (1,640 ft)</td> <td>at 125 kbits/s</td> </tr> <tr> <td>250 m (820 ft)</td> <td>at 250 kbits/s</td> </tr> <tr> <td>100 m (328 ft)</td> <td>at 500 kbits/s</td> </tr> </table> • Maximum number of subscribers: 64 • Transactions: Up to 8 bytes of data per frame. • Possibility of connecting or disconnecting a subscriber without affecting communications between other subscribers. 	① Thick double twisted pair cylindrical cable	③ Flat cable	② Thin double twisted pair cylindrical cable	④ "KwikLink" cable	500 m (1,640 ft)	at 125 kbits/s	250 m (820 ft)	at 250 kbits/s	100 m (328 ft)	at 500 kbits/s
① Thick double twisted pair cylindrical cable	③ Flat cable										
② Thin double twisted pair cylindrical cable	④ "KwikLink" cable										
500 m (1,640 ft)	at 125 kbits/s										
250 m (820 ft)	at 250 kbits/s										
100 m (328 ft)	at 500 kbits/s										

Appendix A: Technical Characteristics

Specific DeviceNet features of the LUFP9 gateway	<ul style="list-style-type: none"> • The LUFP9 gateway is a “group two only server” DeviceNet subscriber (please refer to <i>DeviceNet Specifications</i>). • Fragmentation support for transactions requiring more than 8 bytes of data. • Connections supported: <ul style="list-style-type: none"> 1 “Explicit Connection” 1 “Polled Command/Response” connection 1 “Bit Strobed Command/Response” connection 1 “Change-of-State / Cyclic” connection • Communication speed configured using 2 selector switches. • Gateway’s DeviceNet address (MAC ID) configured using 6 selector switches (address between 0 and 63). • Configuration facilitated by the use of a specific EDS file.
Modbus RTU characteristics	<ul style="list-style-type: none"> • Physical media: RS485 serial link • Network topology: Multipoint linear topology with adapted line terminations (impedance of 120 Ω in parallel with a capacitance of 1 nF) • Communication speed: 1,200 to 57,600 bits/s • Data bits: 8 • Subscriber addresses: 1 to 247. Address 0 reserved for broadcasting. Addresses 65, 126 and 127 reserved if drives and/or starters from <i>Schneider Electric</i> are used on the same Modbus network. • Period of silence: Equivalent to the transmission of 3.5 characters.

⚠ WARNING

USE OF RESERVED MODBUS ADDRESSES

Do not use Modbus addresses 65, 126, or 127 if a gateway’s Modbus slaves will include a Schneider Electric Speed Variation device such as an Altistart soft-starter or an Altivar motor drive. The Altistart and Altivar devices reserve these addresses for other communications, and the use of these addresses in such a system can have unintended consequences.

Failure to follow this instruction may result in death, serious injury, or equipment damage.

Specific Modbus RTU features of the LUFP9 gateway	<ul style="list-style-type: none"> • Maximum number of subscribers (excluding gateway): 8 Modbus slaves. • Maximum number of commands configured: Up to 50 Modbus queries and responses configured for the same gateway using ABC-LUFP Config Tool. • Communication speed: 1,200, 2,400, 4,800, 9,600, or 19,200 bits/s, configured using ABC-LUFP Config Tool. • Period of silence: Possibility of increasing the gateway’s period of silence, in 10 ms steps, using ABC-LUFP Config Tool. • Parity: None, even or odd, configured using ABC-LUFP Config Tool. • Start bits: 1 bit, configuration using ABC-LUFP Config Tool. • Stop bits: 1 or 2 bits, configuration using ABC-LUFP Config Tool. 						
Structure of the LUFP9 gateway’s memory: <div style="text-align: center;">Inputs</div>	<ul style="list-style-type: none"> • 2 bytes for the diagnostics of errors on the downstream network by the gateway (see chapter 5 Gateway Initialization and Diagnostics). • 510 bytes accessible by the DeviceNet master in the form of input data (see Appendix B: Default Configuration, Input Data Memory Area, for the default use of this input data). <table border="1" style="margin-left: auto; margin-right: auto;"> <thead> <tr> <th style="text-align: center;">Addresses</th> <th style="text-align: center;">Input data area</th> </tr> </thead> <tbody> <tr> <td style="text-align: center;">0x0000 0x0001</td> <td style="text-align: center;">Gateway status word (unless “Control/Status Byte” = “Disabled”)</td> </tr> <tr> <td style="text-align: center;">0x0002 : 0x01FF</td> <td style="text-align: center;">Inputs accessible through the DeviceNet master 510 bytes 1 input data area</td> </tr> </tbody> </table>	Addresses	Input data area	0x0000 0x0001	Gateway status word (unless “Control/Status Byte” = “Disabled”)	0x0002 : 0x01FF	Inputs accessible through the DeviceNet master 510 bytes 1 input data area
Addresses	Input data area						
0x0000 0x0001	Gateway status word (unless “Control/Status Byte” = “Disabled”)						
0x0002 : 0x01FF	Inputs accessible through the DeviceNet master 510 bytes 1 input data area						

Appendix A: Technical Characteristics

<p>Structure of the LUF9 gateway's memory:</p> <p style="text-align: center;">Outputs</p>	<ul style="list-style-type: none"> • 2 bytes for the activation or inhibition of the downstream network by the gateway (see chapter 5 Gateway Initialization and Diagnostics). • 510 bytes accessible by the DeviceNet master in the form of output data (see Appendix B: Default Configuration, Output Data Memory Area, for the default use of this output data). <table border="1" style="margin-left: auto; margin-right: auto;"> <thead> <tr> <th style="text-align: left;">Addresses</th> <th style="text-align: left;">Output data area</th> </tr> </thead> <tbody> <tr> <td>0x0200</td> <td rowspan="2">DeviceNet master command word (unless "Control/Status Byte" = "Disabled")</td> </tr> <tr> <td>0x0201</td> </tr> <tr> <td>0x0202</td> <td rowspan="4">Outputs accessible through the DeviceNet master 510 bytes 1 output data area</td> </tr> <tr> <td>:</td> </tr> <tr> <td>0x03FF</td> </tr> <tr> <td></td> </tr> </tbody> </table>	Addresses	Output data area	0x0200	DeviceNet master command word (unless "Control/Status Byte" = "Disabled")	0x0201	0x0202	Outputs accessible through the DeviceNet master 510 bytes 1 output data area	:	0x03FF				
Addresses	Output data area													
0x0200	DeviceNet master command word (unless "Control/Status Byte" = "Disabled")													
0x0201														
0x0202	Outputs accessible through the DeviceNet master 510 bytes 1 output data area													
:														
0x03FF														
<p>Structure of the LUF9 gateway's memory:</p> <p style="text-align: center;">General data</p>	<ul style="list-style-type: none"> • 960 bytes inaccessible through the DeviceNet master. <table border="1" style="margin-left: auto; margin-right: auto;"> <thead> <tr> <th style="text-align: left;">Addresses</th> <th style="text-align: left;">General data area</th> </tr> </thead> <tbody> <tr> <td>0x0400</td> <td rowspan="2">Input area reserved for the Mailboxes (288 bytes)</td> </tr> <tr> <td>0x051F</td> </tr> <tr> <td>0x0520</td> <td rowspan="2">Output area reserved for the Mailboxes (288 bytes)</td> </tr> <tr> <td>0x063F</td> </tr> <tr> <td>0x0640</td> <td rowspan="4">Internal area reserved for the management of the upstream network (384 bytes) (input area / output area / bi-directional area)</td> </tr> <tr> <td>.....</td> </tr> <tr> <td>0x07BF</td> </tr> <tr> <td></td> </tr> </tbody> </table> <p>NOTE: You can use the general data area for Modbus input data (from Modbus responses) if you do not want the DeviceNet master to have access to them. In this case, always use 0x0400 as the starting address. If you reuse the addresses in this area multiple times, the corresponding memory locations will be displayed in red in the "General Area" section of the "Sub-network Monitor" window (see page 58 for an example). However, this will have no consequences on the gateway during run-time.</p>	Addresses	General data area	0x0400	Input area reserved for the Mailboxes (288 bytes)	0x051F	0x0520	Output area reserved for the Mailboxes (288 bytes)	0x063F	0x0640	Internal area reserved for the management of the upstream network (384 bytes) (input area / output area / bi-directional area)	0x07BF	
Addresses	General data area													
0x0400	Input area reserved for the Mailboxes (288 bytes)													
0x051F														
0x0520	Output area reserved for the Mailboxes (288 bytes)													
0x063F														
0x0640	Internal area reserved for the management of the upstream network (384 bytes) (input area / output area / bi-directional area)													
.....														
0x07BF														
<p>Data transfer order (swapping)</p>	<ul style="list-style-type: none"> • DeviceNet network: LSB first and MSB last. • Modbus RTU network: MSB first and LSB last. • LUF9 gateway: MSB stored in the lowest memory address. <p>→ In most cases, the option which should be chosen for Modbus data stored in the gateway's memory is "Swap 2 bytes". This option relates to all "Data" fields for Modbus queries and responses frames.</p>													

Appendix B: Default Configuration

The configuration described below corresponds to the LUF9 gateway's default configuration.

NOTE: This chapter mainly gives the user information about the performance obtained on the downstream Modbus network. It allows the user to decide whether, for example, he should change the period for cyclical exchanges with one or more of the TeSys U motor starters (see chapter 6 Configuring the Gateway).

Configuring Modbus exchanges

The LUF9 gateway carries out four types of exchanges with each of the 8 TeSys U motor starters. The first two exchanges are cyclical and allow you to control and monitor the motor starter. The last two exchanges are aperiodic (only when there is a change in the values of the data to be transmitted to the motor starter) and allow you to read and change the value of any motor starter parameter.

Function	Modbus function	Number of bytes (1)	Exchange between the LUF9 gateway and the TeSys U motor starter
0x03	Read Holding Registers	11.5 + 10.5	Periodic reading (300 ms period) of the TeSys U motor starter's status register (address 455 = 0x01C7) only
0x10	Preset Multiple Registers	14.5 + 11.5	Periodic writing (300 ms period) of the TeSys U motor starter's status register (address 704 = 0x02C0) only
(0x03)	(Read Holding Register)	11.5 + 10.5	Aperiodic reading of the value of a single parameter, for a single TeSys U motor starter at a time (function and address supplied by the user)
(0x06)	(Preset Single Register)	11.5 + 11.5	Aperiodic writing of the value of a single parameter, for a single TeSys U motor starter at a time (function and address and value supplied by the user)

- (1) Number of bytes in the Query + number of bytes in the Response, plus a period of silence of 3.5 characters for each of these two frames (see description of the "Message delimiter (10ms)" parameter in chapter 6.12.3 "Sub-Network" Element). Each byte will be transmitted in the form of a group of 10 bits (8 data bits, 1 start bit and 1 stop bit). These values allow you to calculate the approximate amount of traffic on the downstream Modbus network as follows:

Volume of periodic traffic (300 ms period)..... [(11.5 + 10.5) + (14.5 + 11.5)] × (8 + 1 + 1) = 480 bits

For 1 TeSys U motor starter 1 × 480 × (1,000 ÷ 300) = 1,600 bits/s

For 8 TeSys U motor starters 8 × 480 × (1,000 ÷ 300) = 12,800 bits/s

As a result, on a network operating at 9,600 bits/s, you will need to considerably increase the cycle time for all or part of the periodic Modbus commands. On the other hand, at a speed of 19,200 bits/s (default speed), the available bandwidth is sufficient to allow proper communications, even in occasional degraded mode (frames re-transmission), and to allow the use of aperiodic setup exchanges.

Appendix B: Default Configuration

Content of the Gateway DPRAM Memory

The LUF9 gateway's DPRAM memory contains all of the data exchanged between the gateway and the 8 TeSys U motor starters, as well as two special registers only exchanged between the gateway and the DeviceNet master (words used for managing the downstream Modbus network).

The flow of data exchanged between the TeSys U motor starters, the gateway and the DeviceNet master is shown below, in order to highlight the role of the gateway's memory in these exchanges:

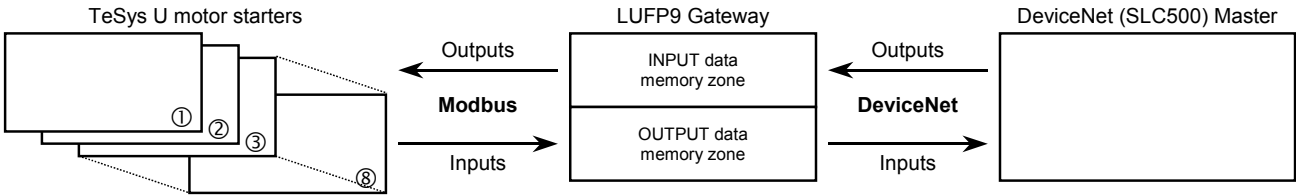

Input Data Memory Area

The gateway has 512 input bytes. Only the first 32 bytes are used. All of these 32 bytes make up the gateway's input area, referenced as "Input 1" in the RSNNetWorx configurator.

Service	Address	Size	Description
Managing the downstream Modbus network	0x0000	1 word	Gateway status word
Periodic communications — Monitoring of TeSys U motor starters	0x0002	1 word	Value of the motor starter ① status register
	0x0004	1 word	Value of the motor starter ② status register
	0x0006	1 word	Value of the motor starter ③ status register
	0x0008	1 word	Value of the motor starter ④ status register
	0x000A	1 word	Value of the motor starter ⑤ status register
	0x000C	1 word	Value of the motor starter ⑥ status register
	0x000E	1 word	Value of the motor starter ⑦ status register
	0x0010	1 word	Value of the motor starter ⑧ status register
—	0x0012	1 byte	Memory location free
Aperiodic communications — Reading the value of a motor starter parameter (RESPONSE)	0x0013	1 byte	Slave no. (0x01 to 0x08)
	0x0014	1 byte	Function number (0x03)
	0x0015	1 byte	Number of bytes read (0x02)
	0x0016	1 word	Value of the parameter read (0xxxxx)
Aperiodic communications — Writing the value of a motor starter parameter (RESPONSE)	0x0018	1 byte	Slave no. (0x01 to 0x08)
	0x0019	1 byte	Function number (0x06)
	0x001A	1 word	Address of the parameter written (0xxxxx)
	0x001C	1 word	Value of the parameter written (0xxxxx)
Aperiodic communications ("Trigger bytes" for the responses)	0x001E	1 byte	Read parameter response counter
	0x001F	1 byte	Write parameter response counter
—	0x0020	1 byte	Free input area (480 bytes)
	
	0x01FF	1 byte	

Appendix B: Default Configuration

Output Data Memory Area

The gateway has 512 output bytes. Only the first 32 bytes are used. All of these 32 bytes make up the gateway's output area, referenced as "Output 1" in the RSNetWorx configurator.

Service	Address	Size	Description
Managing the downstream Modbus network	0x0200	1 word	DeviceNet master command word
Periodic communications — Controlling TeSys U motor starters	0x0202	1 word	Value of the motor starter ① command register
	0x0204	1 word	Value of the motor starter ② command register
	0x0206	1 word	Value of the motor starter ③ command register
	0x0208	1 word	Value of the motor starter ④ command register
	0x020A	1 word	Value of the motor starter ⑤ command register
	0x020C	1 word	Value of the motor starter ⑥ command register
	0x020E	1 word	Value of the motor starter ⑦ command register
Aperiodic communications — Reading the value of a motor starter parameter (QUERY)	0x0210	1 word	Value of the motor starter ⑧ command register
	0x0212	1 byte	Slave no. (0x01 to 0x08)
	0x0213	1 byte	Function number (0x03)
	0x0214	1 word	Address of the parameter to be read (0xxxxx)
Aperiodic communications — Writing the value of a motor starter parameter (QUERY)	0x0216	1 word	Number of parameters to be read (0x0001)
	0x0218	1 byte	Slave no. (0x01 to 0x08)
	0x0219	1 byte	Function number (0x06)
	0x021A	1 word	Address of the parameter to be written (0xxxxx)
Aperiodic communications ("Trigger bytes" for the queries)	0x021C	1 word	Value of the parameter to be written (0xxxxx)
	0x021E	1 byte	Read parameter query counter
	0x021F	1 byte	Write parameter query counter
	0x0220	1 byte	Free output area (480 bytes)
...	...		
0x03FF	1 byte		

Total Number of Modbus Queries and Responses

The total number of Modbus queries and responses is equal to 36 (2 periodic queries and 2 periodic responses for each of the 8 TeSys U motor starters, plus 2 aperiodic queries and 2 aperiodic responses for all of these motor starters). Since the total number of the Modbus queries and responses one can configure for a single gateway is limited to 50, there are only 14 spare Modbus queries and responses (that is to say the equivalent of 7 Modbus commands).

So this reserve does not allow the addition of any single Modbus command for each of the TeSys U motor starters, as this would require the use of 16 Modbus queries and responses (1 query and 1 response for each of the 8 motor starters).

Appendix C: Practical Example (RSLogix 500)

NOTE: This Appendix is reserved for users having a good knowledge of Rockwell Automation RSNetWorx and RSLogix 500 products.

A practical example can be found on the CD LU9CD1. It is made up of two files. The first of these, "SLC_Guide_LUFP9.dnt", shows the configuration of the DeviceNet scanner in RSNetWorx, described in the previous chapters. The second, "SLC_Guide_LUFP9_EN.rss", is an RSLogix 500 file and so this is the example itself.

As the configuration of the RSNetWorx file corresponds exactly to that shown in the previous chapters, we will not be repeating its content here. On the other hand, the RSLogix 500 file is described below, based on the structure of the sub-programs used.

Main Program: "LAD 2 - MAIN_LUFP9"

The role of the main program is to activate the DeviceNet and Modbus communications, and to call the other sub-programs, described in later chapters. The processes carried out in the main program are described below, in the order in which they are run:

- Validation of the scanner's DeviceNet exchanges by activation of bit O:1.0/0.
- Activation of the gateway's Modbus communications using bits 13 (FB_DU) and 14 (FB_HS_SEND) of the DeviceNet master's command word. These two bits correspond to DeviceNet scanner bits O:1.1/5 and O:1.1/6.

NOTE: This process is only relevant provided that the "Control/Status Byte" option is set to "Enabled". With the LUFP9 gateway's default configuration ("Control/Status Byte" = "Enabled but no startup lock"), this process is irrelevant but may still be kept. *Finally, this example should not be used when this option is set to "Disabled", because words I:1.1 and O:1.1 are no longer reserved for "managing the downstream Modbus network". Please see chapter 5 Gateway Initialization and Diagnostics, for further information on this subject.*

- Automatic acknowledgement of the gateway diagnostics by the DeviceNet master. All you have to do is copy the value of bit 15 (ABC_HS_SEND) of the gateway's status word to bit 15 (FB_HS_CONFIRM) of the DeviceNet master's command word (see chapter 5 Gateway Initialization and Diagnostics). This automatic acknowledgement is mainly designed not to halt the mechanism for feeding diagnostics back from the gateway to the DeviceNet master.
- Controlling/monitoring the "TeSys U n°1" motor starter by using sub-program U:3, that is to say the "LAD 3 - CMD_SURV" sub-program. This sub-program uses local variables as parameters. The word N7:0 is used to index both the output register and the input register used to control and monitor the "TeSys U n°1" motor starter. So before calling the sub-program, the value of this word is set to 2 in order to access the words O:1.2 and I:1.2. N7:0 is also used to index one of the bits of each of the registers N7:32, 33, 34 and 35 (registers handled by the user).
- Controlling/monitoring motor starter "TeSys U n°2": *Ditto*, but setting the value of N7:0 to 3 (O:1.3 and I:1.3).
- Controlling/monitoring motor starter "TeSys U n°3": *Ditto*, but setting the value of N7:0 to 4 (O:1.4 and I:1.4).
- Controlling/monitoring motor starter "TeSys U n°4": *Ditto*, but setting the value of N7:0 to 5 (O:1.5 and I:1.5).
- Controlling/monitoring motor starter "TeSys U n°5": *Ditto*, but setting the value of N7:0 to 6 (O:1.6 and I:1.6).
- Controlling/monitoring motor starter "TeSys U n°6": *Ditto*, but setting the value of N7:0 to 7 (O:1.7 and I:1.7).

Appendix C: Practical Example (RSLogix 500)

- Controlling/monitoring motor starter “TeSys U n°7”: *Ditto*, but setting the value of N7:0 to 8 (O:1.8 and I:1.8).
- Controlling/monitoring motor starter “TeSys U n°8”: *Ditto*, but setting the value of N7:0 to 9 (O:1.9 and I:1.9).
- Reading the value of a single parameter out of all of the TeSys U motor starters, by using the U:4 sub-program, that is to say the “LAD 4 - LECT_PAR” sub-program.
- Writing the value of a parameter in a single TeSys U motor starter at a time, by using the U:5 sub-program, that is to say the “LAD 5 - LECT_PAR” sub-program.
- Updating output O:1.16 using the two counters N7:36 and N7:37. This output corresponds to the two “Trigger bytes” that trigger the emission of both the parameter reading request (LSB) and the parameter writing request (MSB). These two counters are independantly updated in the following sub-programs: “LAD 4 – RD_PAR”, for N7:36, and “LAD 5 – WR_PAR”, for N7:37.

NOTE: You can read a parameter on all the motor starters and write a parameter on one of them at the same time as these services use different Modbus commands.

The various data used by the main program are shown in the following table:

Address	Symbol	Description
I:1.1/ 7 → I:1/23	ABC_HS_SEND	Flip flop indicating that there is a new gateway diagnostic
O:1.0/ 0 → O:1/ 0	SCAN_VALIDATION	Enable DeviceNet communications: this bit must be set to 1 to validate the exchanges
O:1.1/ 5 → O:1/21	FB_DU	Activation of Modbus communications by the gateway
O:1.1/ 6 → O:1/22	FB_HS_SEND	Flip flop telling the gateway that there is a new command
O:1.1/ 7 → O:1/23	FB_HS_CONFIRM	Bit used by the DeviceNet master to acknowledge diagnostics of the gateway
N7:0	MODULE	Parameter giving access (index) to the motor starter (called “module” to simplify things)
O:1.16	TRIGGER_OUT_RD_WR	“Trigger bytes” used to trigger the emission of the read parameter request (LSB) or of the write parameter request (MSB)
N7:36	_____	Local counter related to the “trigger byte” of the read parameter request
N7:37	_____	Local counter related to the “trigger byte” of the write parameter request

Controlling/Monitoring Sub-Program for a TeSys U Motor Starter: “LAD 3 - CMD_MON”

The role of this sub-program consists of exercising very simple control over one of the TeSys U motor starters, depending on its current status and the user’s commands. The processes carried out in this sub-program are described below, in the order in which they are run:

- Control of the motor to run forward / in reverse / to stop. Register N7:0 is used as a parameter. It contains the number of both the input word and the output word used to control and monitor the TeSys U motor starter. This same number is used to index one of the bits of each register for registers N7:32 to N7:35. The input word used is located between I:1.2 and I:1.9 (motor starters nos. 1 to 8), and the output word used is located between O:1.2 and O:1.9 (*ditto*). So the value of N7:0 must be between 2 and 9, according to the number of the motor starter currently controlled.

The user controls the motor starter’s running mode using bits 2 to 9 (motor starters nos. 1 to 8) of registers N7:32 (Run (1) / Stop (0)) and N7:33 (Run Forwards (0) / Reverse (1)).

Appendix C: Practical Example (RSLogix 500)

The forward, reverse and stop commands for the TeSys U motor starter are carried out under the following conditions:

- Bit 14 of a TeSys U status word = 0..... The motor starter is not in local mode.
- Bit 2 of a TeSys U status word = 0..... There is no fault on the motor starter.
- Bit 0 of a TeSys U status word = 1..... The motor starter is in the “Ready” or “Switched on” state.

When all of these conditions are met, registers N7:32 and N7:33 (bit 2 to 9, depending on the value of N7:0) are used to control either the motor starter running forwards / in reverse, or to stop it by means of braking. The user updates these two registers bit by bit, according to the commands he wishes to undertake.

- The faults on the TeSys U motor starter are reset. Register N7:0 is used in the same way as above and the input and output words are the same as for controlling the motor starter.

When there is a fault on the motor starter (bit 2 of the monitoring register equal to 1), this fault is copied to one of the bits 2 to 9 (one bit per motor starter) in register N7:34 (Faulty device (1) / Motor starter OK (0)), simply to show this state together with the user command which allows you to reset motor starter faults. This user command corresponds to one of the bits 2 to 9 of register N7:35 (fault reset (1)) and is used to activate bit 3 of the command register of the corresponding TeSys U motor starter (“Reset” bit), that is to say bit O:1.[N7:0]/3.

This fault reset user command is then cancelled by the program when the TeSys U motor starter no longer shows that there is a fault.

Appendix C: Practical Example (RSLogix 500)

The various data used by this sub-program are shown in the following table:

Address	Symbol	Description
I:1.[N7:0]/ 0	—	Bit 0 “Ready” of the TeSys U status register
I:1.[N7:0]/ 1	—	Bit 1 “On” of the TeSys U status register
I:1.[N7:0]/ 2	—	Bit 2 “Fault” of the TeSys U status register
I:1.[N7:0]/14	—	Bit 14 “Reserved: Local control” of the TeSys U motor starter status register
N7:32/[N7:0]	CMD_RUN [MODULE]	User command: Start (1) / Stop (0) on the motor starter whose number is N7:0
N7:33/[N7:0]	CMD_REVERSE [MODULE]	User command: Run forwards (0) / Reverse (1) on the motor starter whose number is N7:0
N7:34/[N7:0]	MON_FAULTY_DEV [MODULE]	User monitoring: Fault (1) / No fault (0) on the motor starter whose number is N7:0
N7:35/[N7:0]	CMD_RESET [MODULE]	User command: Fault reset (1) on the motor starter whose number is N7:0
O:1.[N7:0]/ 0	—	Bit 0 “Reserved: Run Forward” of the TeSys U command register addressed with N7:0
O:1.[N7:0]/ 1	—	Bit 1 “Reserved: Run Reverse” of the TeSys U command register addressed with N7:0
O:1.[N7:0]/ 2	—	Bit 2 “Reserved (brake)” of the TeSys U command register addressed with N7:0
O:1.[N7:0]/ 3	—	Bit 3 “Reset” of the TeSys U command register addressed with N7:0
N7:0	MODULE	Parameter for accessing the motor starter (index between 2 and 9, for TeSys U motor starters nos. 1 to 8)

The example includes a personalized data monitoring screen, known as “CDM 0 - CMD_MON”, in order to simplify the use of this example. The content of this screen is shown below:

Address	Symbol	Display
O:1/ 0	SCAN_VALIDATION	Binary
O:1/21	FB_DU	Binary
O:1/22	FB_HS_SEND	Binary
N7:0	MODULE	Decimal
N7:32	CMD_RUN	Binary
N7:33	CMD_REVERSE	Binary
N7:34	MON_FAULTY_DEV	Binary
N7:35	CMD_RESET	Binary
I:1.2	MON_TESYS_U_1	Binary
O:1.2	CMD_TESYS_U_1	Binary
I:1.3	MON_TESYS_U_2	Binary
O:1.3	CMD_TESYS_U_2	Binary

Address	Symbol	Display
I:1.4	MON_TESYS_U_3	Binary
O:1.4	CMD_TESYS_U_3	Binary
I:1.5	MON_TESYS_U_4	Binary
O:1.5	CMD_TESYS_U_4	Binary
I:1.6	MON_TESYS_U_5	Binary
O:1.6	CMD_TESYS_U_5	Binary
I:1.7	MON_TESYS_U_6	Binary
O:1.7	CMD_TESYS_U_6	Binary
I:1.8	MON_TESYS_U_7	Binary
O:1.8	CMD_TESYS_U_7	Binary
I:1.9	MON_TESYS_U_8	Binary
O:1.9	CMD_TESYS_U_8	Binary

Appendix C: Practical Example (RSLogix 500)

Sub-Program for Reading a Parameter in all TeSys U Motor Starters: “LAD 4 - RD_PAR

The role of this sub-program is to read the value of a single parameter on all TeSys U motor starters. As they are read, the results are placed into an array starting at N7:4 (motor starter no. 1) and ending at N7:11 (motor starter no. 8). Index N7:2 is used to access these various addresses. The processes carried out on this sub-program are described below, in the order in which they are run:

- If the user changes the number (or address) of the parameter to be read (N7:1) this causes the data used by the sub-program to be reinitialized, but only if the previous reading process is finished (B3:0/0 = 0). The comparison between N7:1 (new address) and O:1.11 (address in the last command used) is made through a scratch variable, N9:0, in which the LSB and the MSB of the new address are swapped. The initializations are summarised below:
 - B3:0/0 = 1 A parameter is read on all TeSys U motor starters: In progress.
 - Reset (C5:0) The number of motor starters polled counter is reinitialized.
 - Reset (T4:0) The timer associated with the timeout for a parameter's read response is reinitialized.
 - N7:2 = 4 Index in the array of results → No. of the 1st element in the array = N7:4.
 - N7:3 = 1 Address of the Modbus slave polled → Address of the first TeSys U motor starter, that is to say 1.
 - N7:[4..11] = 0 The contents of the array of results is reset.
 - B3:0/5 = 0 Enables the update of the “trigger byte” that will trigger the emission of the query.
- The output data corresponding to the read query is updated (O:1.10 to O:1.12) and the N7:36 counter (“trigger byte”) is increased by one. This update is only done once (bit B3:0/5 used for this purpose). **Reminder:** In the LUF9 gateway's default configuration, this output data corresponds to the personalized Modbus command “Transactions 1” of the “TeSys U n°1” node. The query frame for this personalized command is sent when the “trigger byte” located in bits 0-7 of O:1.16 is changed (“Update mode” = “Change of state on trigger”). As a result, increasing the N7:36 counter, then updating O:1.16 using N7:36 (in “LAD 2 – MAIN_LUF9”), causes this query to be sent. On the other hand, the output data O:1.10 to O:1.12 must be valid so that the content of the Modbus query remains coherent!
- The data from the Modbus response which corresponds to this read command is checked. The values of inputs I:1.10 and I:1.11 are compared to those of output O:1.10 and the value 0x02xx (AND mask set to 0xFF00) in order to determine whether the response to the command has arrived or not. If the slave number and the function number correspond to those of the query (see above) and the number of bytes of data received is correct, bit B3:0/1 is activated in order to tell the rest of the sub-program that the response has arrived and that it is correct. The N9:0 scratch variable is used to compare the inputs and the outputs in the same format.
- The value of the read parameter is copied into the array of results. So the value of I:1.12 is transferred to the location reserved for the result of the motor starter currently being polled (use of index N7:2). This transfer only takes place if the response has arrived and its content is correct (bit B3:0/1 is active). The LSB and the MSB for this value are then swapped in this array so as to restore the value of the read parameter. The timer for the response timeout (T4:0) is reinitialized to allow the process of reading the same parameter on the next motor starter.
- Management of the response timeout (TON block on variable T4:0). Until the response arrives or if its content is incorrect (bit B3:0/1 = 0), a 3-second timer is set. When this timeout (T4:0/DN = 1) is triggered, the related timer is reinitialized and a result set to -1 is placed in the array of results, at the location normally reserved for the motor starter being polled.
- On receipt of the response, or after the timeout has been triggered, the internal data used by this sub-program is updated to allow the same parameter to be read on the next motor starter, up to the last of the 8 motor starters (addresses 1 to 8). Counter C5:0 is used to count the number of motor starters which have been polled so far.
- When the reading of the 8th motor starter is finished (counter C5:0 reaching its preset value), the reading process is halted (bit B3:0/0 is reset). However, until the reading of the parameter for the 8th motor starter has finished, the sub-program restarts the next PLC cycle from the beginning (moving onto the next motor starter or continuing to wait for a response for the motor starter currently being polled).

Appendix C: Practical Example (RSLogix 500)

The various data used by this sub-program are shown in the following table:

Address	Symbol	Description
B3:0/0	RD_RUNNING	Reading a parameter on all TeSys U motor starters: In progress
B3:0/1	RD_OK_KO	Reading a parameter on all TeSys U motor starters: Reading is correct (OK) or incorrect (KO) for a motor starter (if the response has arrived or when timeout T4:0 is triggered)
B3:0/5	————	The “trigger byte” of the query has been updated: Yes (1) / No (0)
C5:0	CPT_RD_TESYS_U	Reading a parameter on the TeSys U motor starters: Counter. When the value of this counter reaches 9, the process of reading a parameter on all of the TeSys U motor starters is halted.
I:1.10	CR_RDPAR_XXX_SLAVE	Result of reading a parameter: Slave (0x01 to 0x08) as MSB. The value of this field is compared to that of the corresponding field in the query frame. The LSB of this input word is not used.
I:1.11	CR_RDPAR_FCT_BYTES	Result of reading a parameter: Function (always 0x03) as LSB (the value of this field is compared to that of the corresponding field in the query frame) + number of bytes read (0x02) as MSB (value masked and checked).
I:1.12	CR_RDPAR_VALUE	Result of reading a parameter: Value of the parameter read (MSB and LSB are swapped). This value is placed in array N7:[N7:2], then its MSB and its LSB are swapped there in order to restore the correct value of the read parameter.
N7:1	NUMPARAM	User command: Number of the read parameter.
N7:2	RD_INDEX	Index in the array of results for the reading of a TeSys U parameter. Value = 4 to 11 (motor starters nos. 1 to 8).
N7:3	ADDRESS	Address of the Modbus slave for which one of the parameters is currently being read. Value = 1 to 8.
N7:[N7:2]	— [RD_INDEX]	Array of results used for the reading of a TeSys U parameter (motor starters nos. 1 to 8). Elements N7:4 to N7:11 (see N7:2). Value = -1 in case of error (response timeout triggered).
N7:36	————	Local counter that corresponds to the “trigger byte” of the read request.
N9:0	VAR_TEMP_1	Temporary scratch variable used to carry out intermediate evaluations.
O:1.10	RDPAR_SLAVE_FCT	Request for the reading of a parameter: Slave (from 0x01 to 0x08) as LSB + function (always 0x03) as MSB.
O:1.11	RDPAR_ADRPAR	Request for the reading of a parameter: Address of the parameter (copied from N7:1, but with MSB and LSB swapped).
O:1.12	RDPAR_NBPARS	Request for the reading of a parameter: Number of parameters to be read (always 0x0001, but with the MSB and LSB swapped, that is to say 0x0100).
T4:0	TIMEOUT_RD_PARAM	Timer for the timeout of the parameter reading command (3 seconds)

The example includes a personalized screen for monitoring the data, called “CDM 1 - RD_PAR”, in order to simplify the use of this example. The content of this screen is shown below:

Address	Symbol	Display
N7:1	NUMPARAM	Decimal
B3:0/0	RD_RUNNING	Binary
B3:0/1	RD_OK_KO	Binary
N7:2	RD_INDEX	Decimal
N7:3	ADDRESS	Decimal
N7:4	RDPAR1	Decimal
N7:5	RDPAR2	Decimal
N7:6	RDPAR3	Decimal
N7:7	RDPAR4	Decimal
N7:8	RDPAR5	Decimal
N7:9	RDPAR6	Decimal

Address	Symbol	Display
N7:10	RDPAR7	Decimal
N7:11	RDPAR8	Decimal
O:1.10	RDPAR_SLAVE_FCT	Hexadecimal
O:1.11	RDPAR_ADRPAR	Decimal
O:1.12	RDPAR_NBPARS	Hexadecimal
I:1.10	CR_RDPAR_XXX_SLAVE	Hexadecimal
I:1.11	CR_RDPAR_FCT_BYTES	Hexadecimal
I:1.12	CR_RDPAR_VALUE	Hexadecimal
I:1.16	TRIGGER_IN_RD_WR	Hexadecimal
O:1.16	TRIGGER_OUT_RD_WR	Hexadecimal
N7:36	————	Hexadecimal
B3:0/5	————	Binary

Appendix C: Practical Example (RSLogix 500)

Sub-Program for Writing a Parameter on a Single TeSys U Motor Starter: “LAD 5 - WR_PAR

The role of this sub-program consists of writing the value of a parameter on a single TeSys U motor starter. The user should enter the address of the TeSys U motor starter (N7:12), the address of the parameter (N7:13) and the value to be assigned to the parameter (N7:14). Finally, he should activate bit B3:0/2 to activate the writing process. This bit is automatically reset by the LAD 5 sub-program. When the writing process is finished, the result of the writing (address of the parameter and value of the parameter) is copied in an array starting at N7:16 (for motor starter no. 1) and ending at N7:31 (for motor starter no. 8), using variable N7:15 as an index. Two successive cells of this array are used for each motor starter: The first receives the parameter's address and the second its value. The processes carried out by this sub-program are described below, in the order in which they are run:

- The sub-program goes into standby mode. The rest of the sub-program is not run until the user has activated bit B3:0/2. This allows the user to enter the values of data N7:12, 13 and 14 one after another beforehand.
- The data the sub-program uses subsequently is initialized, but only if the writing process is finished (B3:0/3 = 0). These initializations are summarised below:
 - B3:0/2 = 0 **User command:** The command for writing a parameter on a TeSys U motor starter is reset.
 - B3:0/3 = 1 A parameter is written on a TeSys U motor starter: In progress.
 - Reset (T4:1) The timer related to the timeout of the parameter write response is reset.
 - $N7:15 = (N7:12 \times 2) + 14$ Index in the array of results.
 - $N7:[N7:15] = \{ 0 ; 0 \}$ The content of the array of results is reset, but only for the motor starter affected by the write query (two successive bytes).
 - B3:0/6 = 0 Enables the update of the “trigger byte” that will trigger the emission of the query.
- The output data corresponding to the write query is updated (O:1.13 to O:1.15) and the N7:37 counter (“trigger byte”) is increased by one. This update is only done once (bit B3:0/6 used for this purpose). **Reminder:** In the LUF9 gateway's default configuration, this output data corresponds to the personalized Modbus command “Transactions 2” of the “TeSys U n°1” node. The query frame for this personalized command is sent when the “trigger byte” located in bits 8-15 of O:1.16 is changed (“Update mode” = “Change of state on trigger”). As a result, increasing the N7:37 counter, then updating O:1.16 using N7:37 (in “LAD 2 – MAIN_LUF9”), causes this query to be sent. On the other hand, the output data O:1.13 to O:1.15 must be valid so that the content of the Modbus query remains coherent! The LSB and the MSB of outputs O:1.14 and O:1.15 must be swapped. The scratch variable N9:0 is used to carry out this swap between variables N7:13 and N7:14 and outputs O:1.14 and O:1.15.
- The data from the Modbus response which corresponds to this write command is checked. The values of inputs I:1.13 to I:1.15 are compared to those of outputs O:1.13 to O:1.15 to determine whether the response to the command has arrived or not. If the slave number, the function number, the address of the parameter and its value correspond to those of the query (see above) and the number of bytes of data received is correct, bit B3:0/4 is activated in order to tell the rest of the sub-program that the response has arrived and that it is correct.
- The address and the value of the parameter are copied into two successive locations in the array of results (indexing carried out using N7:15), reserved for the motor starter currently being polled and only takes place if the response has arrived and its content is correct (bit B3:0/4 active). The LSB and the MSB for each of these two items of data are then swapped to restore its correct value. The timer for the response timeout (T4:1) is reinitialized to ready the program for a future write command. Bit B3:0/3 is reset to show that the command is finished, thus avoiding having to run the rest of the sub-program.

Appendix C: Practical Example (RSLogix 500)

- Management of the response timeout (T4:1). Until the response arrives or if its content is incorrect (bit B3:0/4 = 0), a 3-second timer is set. When this timeout (T4:1/DN = 1) is triggered, the timer is reinitialized, the parameter's address (O:1.14, after LSB / MSB have been swapped using scratch variable N9:0) and an erroneous value (N9:1 = -1) are placed in the array of results, into two successive locations, reserved for the motor starter currently being polled. Finally, the write process is halted (bit B3:0/3 is reset).

The various data used by this sub-program are shown in the following table:

Address	Symbol	Description
B3:0/2	WR_COMMAND	User command: Writing a parameter on a TeSys U motor starter. This bit is activated by the user and reset by the program.
B3:0/3	WR_RUNNING	Writing a parameter on a TeSys U motor starter: In progress
B3:0/4	WR_OK	Writing a parameter on a TeSys U motor starter: Writing OK (if the response has arrived and is correct)
B3:0/6	————	The "trigger byte" of the query has been updated: Yes (1) / No (0)
I:1.13	CR_WRPAR_SLAVE_FCT	Result of writing the value of a parameter: Slave (0x01 to 0x08) as LSB + function (always 0x06) as MSB. The values of these fields are compared to those of the query
I:1.14	CR_WRPAR_ADRPAR	Result of writing the value of a parameter: Address of the parameter. The value of this field is compared to that of the query (swapping of the MSB and the LSB with each of these two fields)
I:1.15	CR_WRPAR_VALUE	Result of writing the value of a parameter: Value of the written parameter. The value of this field is compared to that of the query (swapping of the MSB and the LSB with each of these two fields)
N7:12	WR_SLAVE	User command: Modbus address of the motor starter to which the write request should be sent.
N7:13	WR_ADDRESS	User command: Address of the parameter NOTE: Do not attempt to change the value of register 704 (command register), because it is already controlled by the DeviceNet master (see sub-program "LAD 3 - CMD_MON")!
N7:14	WR_VALUE	User command: New value of the parameter
N7:15	WR_INDEX	Index in the array of results for writing TeSys U parameters (motor starters nos. 1 to 8). Value = 16 + 2 × (motor starter no. - 1) = 16 to 30
N7:[N7:15]	— [WR_INDEX]	Array of results for writing TeSys U parameters (motor starters nos. 1 to 8). Elements N7:16 to N7:31 organized by "parameter address" / "parameter value" pairs, each pair occupying two successive addresses. "Parameter value" = -1 if there is an error (response timeout triggered).
N7:37	————	Local counter that corresponds to the "trigger byte" of the read request.
N9:0 N9:1	VAR_TEMP_1 VAR_TEMP_2	Temporary variables used to carry out the intermediate evaluations (primarily LSB / MSB swappings).
O:1.13	WRPAR_SLAVE_FCT	Request for writing the value of a parameter: Slave (copied from N7:12) as LSB + function (always 0x06) as MSB.
O:1.14	WRPAR_ADRPAR	Request for writing the value of a parameter: Address of the parameter (copied from N7:13, but with MSB and LSB swapped).
O:1.15	WRPAR_VALUE	Request for writing the value of a parameter: Value of the parameter (copied from N7:14, but with MSB and LSB swapped).

Appendix C: Practical Example (RSLogix 500)

Address	Symbol	Description
S:24	INDEX_SYS	Index register used in indexed addressing (prefix: '#')
T4:1	TIMEOUT_WR_PARAM	Timer for the timeout of the parameter writing command (3 seconds)

The example includes a personalized screen for monitoring the data, called “CDM 2 - WR_PAR”, in order to simplify the use of this example. The content of this screen is shown below:

Address	Symbol	Display
N7:12	WR_SLAVE	Decimal
N7:13	WR_ADDRESS	Decimal
N7:14	WR_VALUE	Decimal
B3:0/2	WR_COMMAND	Binary
B3:0/3	WR_RUNNING	Binary
B3:0/4	WR_OK	Binary
N7:15	WR_INDEX	Decimal
N7:16	WRPAR_1_ADDRESS	Decimal
N7:17	WRPAR_1_VALUE	Decimal
N7:18	WRPAR_2_ADDRESS	Decimal
N7:19	WRPAR_2_VALUE	Decimal
N7:20	WRPAR_3_ADDRESS	Decimal
N7:21	WRPAR_3_VALUE	Decimal
N7:22	WRPAR_4_ADDRESS	Decimal
N7:23	WRPAR_4_VALUE	Decimal
N7:24	WRPAR_5_ADDRESS	Decimal

Address	Symbol	Display
N7:25	WRPAR_5_VALUE	Decimal
N7:26	WRPAR_6_ADDRESS	Decimal
N7:27	WRPAR_6_VALUE	Decimal
N7:28	WRPAR_7_ADDRESS	Decimal
N7:29	WRPAR_7_VALUE	Decimal
N7:30	WRPAR_8_ADDRESS	Decimal
N7:31	WRPAR_8_VALUE	Decimal
O:1.13	WRPAR_SLAVE_FCT	Hexadecimal
O:1.14	WRPAR_ADRPAR	Hexadecimal
O:1.15	WRPAR_VALUE	Hexadecimal
I:1.13	CR_WRPAR_SLAVE_FCT	Hexadecimal
I:1.14	CR_WRPAR_ADRPAR	Hexadecimal
I:1.15	CR_WRPAR_VALUE	Hexadecimal
I:1.16	TRIGGER_IN_RD_WR	Hexadecimal
O:1.16	TRIGGER_OUT_RD_WR	Hexadecimal
N7:37	_____	Hexadecimal
B3:0/6	_____	Binary

Restrictions relating to the RSLogix 500 example

This example is not perfect. For instance, with an incorrect response (wrong slave number, function number, etc.), the program performs no particular processing and continues to wait for a response until it times out, even though the gateway has not re-transmitted anything because, from its point of view, the response is correct. In fact, as the whole content of the Modbus response is placed in a “Data” field, it will not be checked before being copied into the gateway’s memory. Only the frame’s Checksum is checked by the gateway.

The two “trigger bytes” located in the input word I:1.16 are not used. You should use them if it is relevant for your application to be notified each time a response related to the two personalized commands “Transactions 1” and “Transactions 2” is received by the gateway.

Compatibility with the various options offered for the “Control/Status Byte” field in “ABC” (see chapter 5 Gateway Initialization and Diagnostics) is only partially dealt with in this example. The improvements required relate mainly to managing bits 14 and 15 of the DeviceNet master’s command word and the gateway’s status word (bits 6 and 7 of the corresponding input I:1.1 and output O:1.1). Also, the use of gateway diagnostics (EC and ED fields) still needs to be defined by the user.

Appendix D: DeviceNet Objects

Introduction to the Gateway's DeviceNet Objects

The LUPP9 gateway's software has been developed in accordance with the **Object Modelling** from the DeviceNet protocol. This model leads to a method used for addressing the gateway's data, known as *Attributes*, made up of four separate values: ① the *node address* (MAC ID), ② the *Object's class identifier* (Class ID), ③ the *Instance Number* (Instance ID) and ④ the *Attribute Number* (Attribute ID). An address made up in this way is known as a "**Path**". The *Connection by Explicit Messaging*, for example, uses paths of this sort to exchange data from one point to another on a DeviceNet network.

Address	Min. – max.	Description
Node	0 – 63	This field allows you to address one subscriber out of the series of subscribers on a DeviceNet network using its MAC ID .
Class	1 – 65 535	All objects sharing the same characteristics belong to the same class, characterized by its Class ID .
Instance	0 – 65 535	The instances represent the various objects from one class. All instances from one class share the same behaviours (1) and the same attributes , but each of them has its own set of values for these attributes. When a subscriber creates an instance (instantiation), he assigns a unique Instance ID , which allows the other DeviceNet subscribers to have individual access to it.
Attribute	1 – 255	Each attribute represents one of the characteristics of the Instances belonging to the same class. It is assigned some sort of value (byte, unsigned integer, character string, etc.) in order to supply information about the subscriber's status or to make settings on the subscriber's behaviours (1). NOTE: To access the attributes of an object's base class, you need to use Instance 0x00 when entering the full path. e.g. to access the "Revision" attribute from the "Identity Object" class for DeviceNet subscriber no. 4, you will need to use the following path: "0x04 • 0x01 • 0x00 • 0x01".

(1) The behaviors designate actions taken by a DeviceNet object in response to particular events.

List of the Gateway's DeviceNet Objects

Class	ID	Required	Instances	Interfaces
Identity object	0x01	Yes	1	Message router
Message router	0x02	Yes	1	Explicit message connection
DeviceNet object	0x03	Yes	1	Message router
Assembly object	0x04	No	2 (1)	I/O connections or Message router
Connection object	0x05	Yes	4 (2)	I/O connections or Explicit messages
Acknowledge handler object	0x2B	No	1	I/O connections or Message router
I/O data input mapping object	0xA0	No	1	Message router
I/O data output mapping object	0xA1	No	1	Message router
Diagnostic object	0xAA	No	1	Message router

(1) One input area and one output area are created in the gateway's memory.

(2) The four instantiated connections are as follows: ① Explicit Connection, ② Polled Command/Response, ③ Bit Strobed Command/Response and ④ Change-of-State / Cyclic. The last three connections are of the "I/O Connection" type.

Appendix D: DeviceNet Objects

Graphical Representation of the Gateway's DeviceNet Objects

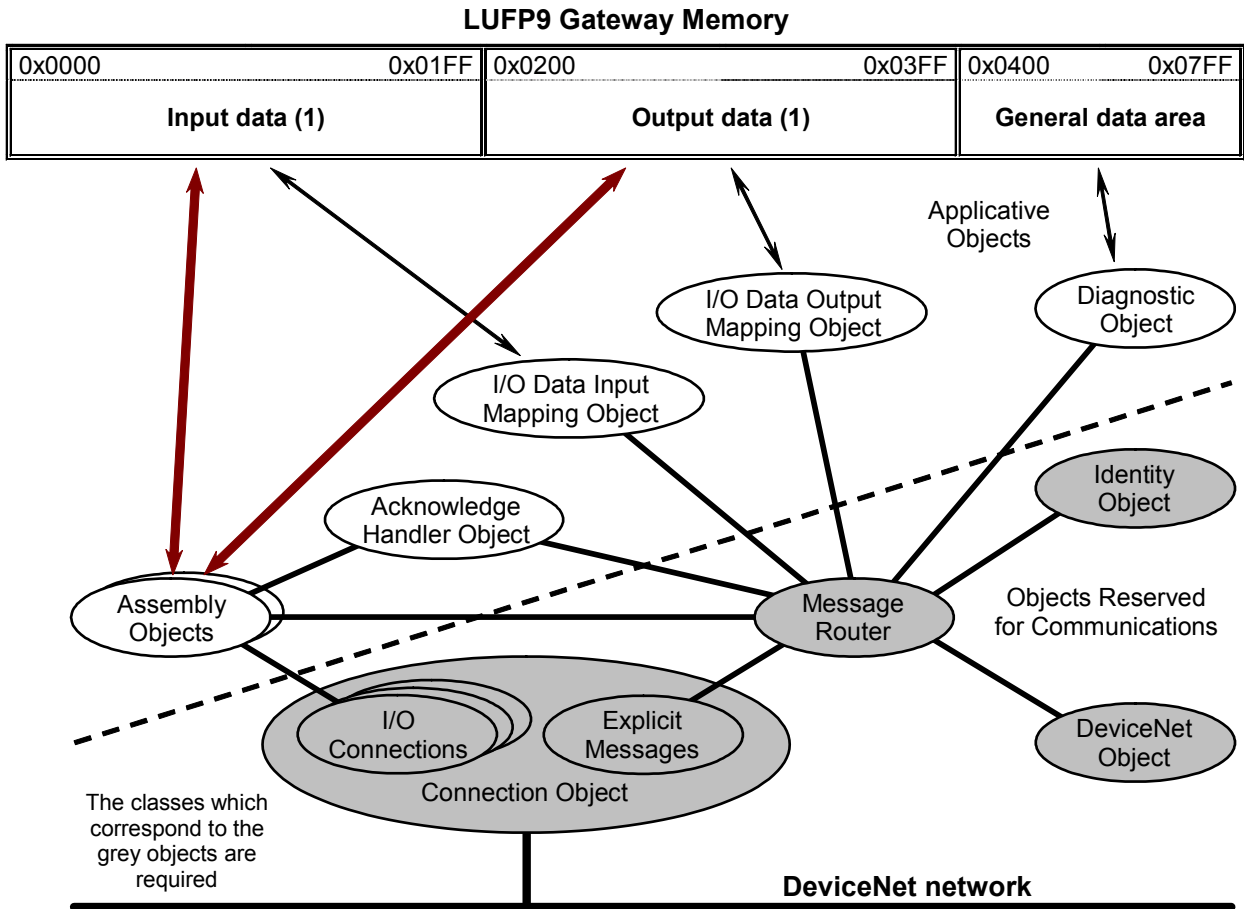

(1) The input and output data areas can be read or written either using “I/O connections” or using “explicit messages”.

Identity Object (class 0x01)

The “Identity” object only has a single instance (Instance ID = 0x01). This object contains general information allowing you to identify the gateway and diagnose its status. This object is described in chapter 6-2. of volume II of the DeviceNet specifications on the ODVA website.

Attributes of class 0x01

ID	Access	Name	Need	Type	Value	Description
0x01	Get	Revision	Required	UINT	1	Major and minor indices for the revision of the “Identity Object”.

Services in class 0x01

Service code	Name of the service	Need	Description
0x0E	Get_Attribute_Single	Required	This service allows the value of one of the attributes of the class to be read.

Appendix D: DeviceNet Objects

Attributes of instance 0x01 of class 0x01

ID	Access	Name	Need	Type	Value																			
0x01	Get	Vendor ID	Required	UINT	90																			
	All vendor IDs for DeviceNet products are managed by the ODVA. With the LUF9 gateway, this ID is set to 90 (gateways from <i>HMS Fieldbus Systems AB (Hassbjer Micro Sys)</i>).																							
0x02	Get	Device type	Required	UINT	12																			
	The list of the various types of DeviceNet products is managed by the ODVA. This attribute allows a DeviceNet subscriber's profile to be identified, and the minimum requirements and options commonly used by the subscribers in this profile to be deduced. The LUF9 gateway is a "Communication Adapter" product (see chapter 3-7. of volume II of the DeviceNet specifications).																							
0x03	Get	Product code	Required	UINT	60																			
	This attribute is managed by the manufacturer of the product, thus allowing him to characterize his own products. He uses it to identify each of his products within the same product family ("device type" attribute). This allows products with differences in terms of their configurations and/or their options to be characterized.																							
0x04	Get	Revision	Required	USINT, USINT	3, 1																			
	Major and minor indices allowing the "Identity Object" to be identified. The value of each of the two members of this attribute may not be null. The conventional representation of the revision indices is "major.minor", with 3 digits for the minor index, completed to the left by zeros if necessary. The major index is limited to 7 data bits. Its 8th bit is reserved and should be set to zero.																							
0x05	Get	Status	Required	WORD	(16-bit register)																			
	<p>This attribute is a summary of the product's general status. This is a 16-bit register:</p> <table border="0"> <tr> <td>Bit 0</td> <td>Allocated to a master (predefined master/slave connection set).</td> <td>Bit 8.....</td> <td>Minor recoverable fault.</td> </tr> <tr> <td>Bit 1</td> <td>Reserved (value = 2#0).</td> <td>Bit 9.....</td> <td>Minor unrecoverable fault.</td> </tr> <tr> <td>Bit 2</td> <td>Configured product.</td> <td>Bit 10.....</td> <td>Major recoverable fault.</td> </tr> <tr> <td>Bits 3-7</td> <td>Reserved (value = 2#00000).</td> <td>Bit 11.....</td> <td>Major unrecoverable fault.</td> </tr> <tr> <td></td> <td></td> <td>Bits 12-15.....</td> <td>Reserved (value = 2#0000).</td> </tr> </table>					Bit 0	Allocated to a master (predefined master/slave connection set).	Bit 8.....	Minor recoverable fault.	Bit 1	Reserved (value = 2#0).	Bit 9.....	Minor unrecoverable fault.	Bit 2	Configured product.	Bit 10.....	Major recoverable fault.	Bits 3-7	Reserved (value = 2#00000).	Bit 11.....	Major unrecoverable fault.			Bits 12-15.....
Bit 0	Allocated to a master (predefined master/slave connection set).	Bit 8.....	Minor recoverable fault.																					
Bit 1	Reserved (value = 2#0).	Bit 9.....	Minor unrecoverable fault.																					
Bit 2	Configured product.	Bit 10.....	Major recoverable fault.																					
Bits 3-7	Reserved (value = 2#00000).	Bit 11.....	Major unrecoverable fault.																					
		Bits 12-15.....	Reserved (value = 2#0000).																					
0x06	Get	Serial number	Required	UDINT	(variable)																			
	<p>The product's serial number is combined with the "vendor ID" attribute to produce a unique identifier for each DeviceNet product. Each manufacturer must take responsibility for guaranteeing that all the DeviceNet products he manufactures have a unique serial number.</p> <p>Sample "serial number:" 0x 23 00 DD 20.</p>																							
0x07	Get	Product name	Required	SHORT_STRING	"Anybus-C DeviceNet"																			
	<p>This attribute gives visual identification method and takes the form of an ASCII string. This text gives a short description of the product, or the product family, equivalent to the "product code" attribute (0x03).</p> <p>The byte preceding this ASCII string shows the total length of this string, from first to the last character. With the LUF9 gateway, the total number of bytes included in the "product name" attribute is set to 24. The "Anybus-C DeviceNet" string has 18 characters (including spaces). The whole content of the "product name" attribute, with the LUF9 gateway, is therefore equal to: 0x 12 41 6E 79 62 75 73 2D 43 20 44 65 76 69 63 65 4E 65 74 00 00 00 00 00. The bytes which are not shown in bold are the content of the ASCII string (length = 0x12).</p>																							
0x09	Get	Configuration consistency value	Optional	UINT	(variable)																			
	<p>The value of this attribute allows the validity of the product's configuration to be checked. The product automatically updates this attribute when the value of any non-volatile attribute is changed. The product's behaviour when an error in the integrity of the configuration is detected is specific to each type of product. In the same way, the method used to calculate the value of this attribute depends entirely on the product: CRC, unit counter, etc.</p> <p>So this attribute allows a DeviceNet master, for instance, to check that the configuration of the DeviceNet product has not been changed.</p> <p>NOTE: In addition to calculating the value of this attribute, the LUF9 gateway uses its LED  DEVICE STATUS to warn the user when its configuration is not valid (the LED flashes red/green).</p>																							

Services of instance 0x01 of class 0x01

Service code	Name of the service	Requirement	Description
0x05	Reset	Required	This service allows to restart the gateway (power cycle).
0x0E	Get_Attribute_Single	Required	This service allows to read the value of one of the instance attributes.

Appendix D: DeviceNet Objects

Message Router Object (class 0x02)

The “Message Router” object is the element through which all objects of the “Explicit messages” type go so that they can be routed to the objects they are intended for. It has only one instance (Instance ID = 0x01). This object is described in chapter 6-3. of volume II of the DeviceNet specifications.

Attributes of class 0x02

ID	Access	Name	Need	Type	Value	Description
0x01	Get	Revision	Optional	UINT	1	Revision index of the “Message Router Object” class.

Services in class 0x02

Service code	Name of the service	Need	Description
0x0E	Get_Attribute_Single	Required	This service allows to read the value of one of the class attributes.

Attributes of instance 0x01 of class 0x02

This instance has no attributes.

DeviceNet Object (class 0x03)

The “DeviceNet” object has only one instance (Instance ID = 0x01). This object contains the status of the general configuration of the gateway’s node on the DeviceNet network. It is described in chapter 5-5. of volume II of the DeviceNet specifications. The LUFP9 gateway is a “Group 2 only server” type subscriber (see chapter 7-9. of volume I of the DeviceNet specifications).

Attributes of class 0x03

ID	Access	Name	Need	Type	Value	Description
0x01	Get	Revision	Required	UINT	2	Revision index of the definition of the class of the “DeviceNet Object” currently used for the implementation of the gateway’s DeviceNet communications functions. (1)

(1) This index must be between 1 and 65,535 and will be incremented if the definition of the class is replaced by a more recent definition.

Services in class 0x03

Service code	Name of the service	Need	Description
0x0E	Get_Attribute_Single	Optional	This service allows to read the value of one of the class attributes.

Attributes of instance 0x01 of class 0x03

ID	Access	Name	Need	Type	Value
0x01	Get	MAC ID	Required	USINT	0 to 63
		The value of this attribute corresponds to the gateway’s address on the DeviceNet network (MAC ID), that is to say to the address configured using the selector switches described in chapter 2.7.2 Encoding the Gateway Address.			
0x02	Get	Baud rate	Optional	USINT	0 to 2
		The value of this attribute corresponds to the baud rate of the DeviceNet network, as configured on the gateway using the selector switches described in chapter 2.7.1 Encoding DeviceNet Speed. This speed must be the same for all subscribers on the DeviceNet network. The few possible values for this attribute are as follows: 0 (125 kbits/s), 1 (250 kbits/s) and 2 (500 kbits/s).			

Appendix D: DeviceNet Objects

ID	Access	Name	Need	Type	Value
0x05	Get	Allocation information	Required	BYTE , USINT	(variable)
<p>This attribute supplies general information about the DeviceNet allocation method currently being used. It is made up of the “allocation choice”, in BYTE format and the “master’s MAC ID”, in USINT format and whose value is between 0 and 63. If the “master’s MAC ID” is set to 255 (which is the case when the gateway is initialized), this means that there is no allocation when using the “Predefined Master/Slave Connections Set.” Please see chapters 3-4., 5-5.4.2., and 7. of volume I of the DeviceNet specifications for further details on this subject.</p> <p><i>Example : 0x03, 0x00.</i></p>					

Services of instance 0x01 of class 0x03

Service code	Name of the service	Need	Description
0x0E	Get_Attribute_Single	Optional	This service allows to read the value of one of the instance attributes.
0x4B	Allocate Master/Slave Connection Set	Optional	This service allows the master/slave connection to be allocated to a DeviceNet master, at the latter’s request.
0x4C	Release Master/Slave Connection Set	Optional	This service allows the master/slave connection previously allocated to a DeviceNet master to be cleared, at the latter’s request.

Assembly Objects (Class 0x04)

As a general rule, objects from the “Assembly” class are used to group attributes (data) belonging to different objects within a single attribute. This allows them to be accessed using a single message. With the LUPF9 gateway, this class has only 2 instances, each one being assigned to the input area (Instance ID = 0x64) or to the output area (Instance ID = 0x96) of the gateway. This object is described in chapter 6-5. of volume II of the DeviceNet specifications.

The first instance (Instance ID = 0x64) is assigned to the gateway’s input data area. This input area gathers all the memory locations receiving data from a Modbus response to be relayed to the DeviceNet master. The second instance (Instance ID = 0x96) is assigned to the gateway’s output data area. This output area gathers all the memory locations receiving data to be placed in a Modbus query, that is to say all the data transmitted by the DeviceNet master.

Attributes of class 0x04

ID	Access	Name	Need	Type	Value	Description
0x01	Get	Revision	Required	UINT	2	Revision index of the “Assembly Object” class.

Services in class 0x04

Service code	Name of the service	Need	Description
0x0E	Get_Attribute_Single	Optional	This service allows to read the value of one of the class attributes.

Appendix D: DeviceNet Objects

Attributes of instance 0x64 of class 0x04 (MODBUS INPUTS)

ID	Access	Name	Need	Type	Value
0x03	Get	Data	Required	USINT [...]	(array of values)
The data gathered within this attribute correspond to the data of the attribute 0x01 of instance 0x01 from the I/O Data Input Mapping Object. With the default configuration, the size of instance 0x64 (input data area of the gateway) is equal to 32 bytes and the data related to the attribute 0x03 of this instance corresponds to the description given in Appendix B: Default Configuration, Input Data Memory Area..					

Attributes of instance 0x96 of class 0x04 (MODBUS OUTPUTS)

ID	Access	Name	Requirement	Type	Value
0x03	Get / Set	Data	Required	USINT [...]	(array of values)
The data gathered within this attribute correspond to the data of the attribute 0x01 of instance 0x01 from the I/O Data Output Mapping Object. With the default configuration, the size of instance 0x96 (output data area of the gateway) is equal to 32 bytes and the data related to the attribute 0x03 of this instance corresponds to the description given in Appendix B: Default Configuration, Output Data Memory Area.					

Services of instances 0x64 and 0x96 of class 0x04

Service code	Name of the service	Need	Description
0x0E	Get_Attribute_Single	Required	This service allows to read the array of values that corresponds to the attribute 0x03 of one of the instances of the "Assembly Object."
0x10	Get_Attribute_Single	Optional	This service allows to write an array of values into the array of the attribute 0x03 of one of the instances of the "Assembly Object."

Connection Object (Class 0x05)

With the LUFF9 gateway, the "Connection" object has up to four instances (Instance ID = 0x01 to 0x04). Each of these instances represents one of the two ends of a virtual connection established between two nodes on the DeviceNet network, in this case the DeviceNet master node and the gateway node. Each instance of this object belongs to one of the two following types of connection: Explicit connection, allowing *Explicit Messages* to be sent, or implicit connection (*I/O Connections*). This object is described in chapter 5-4. of volume II of the DeviceNet specifications.

Here is a brief description of the four instances of the LUFF9 gateway's "Connection" object, and then details are given in the rest of this chapter:

Instance ID	Type of connection	Connection name
0x01	Explicit Messaging	Explicit Connection
0x02	I/O Connection	Polled Command/Response Connection
0x03	I/O Connection	Bit Strobed Command/Response Connection
0x04	I/O Connection	Change-of-State / Cyclic (Acknowledged) Connection

Each message of an "Explicit Messaging" type connection contains the full addressing path and the values of the attribute involved, as well as the Service Code describing the action to be taken.

Each message of an "I/O Connection" type connection contains only the I/O data. All of the information describing the use of this data is located in the instance of the "Connection Object" associated with this message.

Appendix D: DeviceNet Objects

The “Change-of-State / Cyclic Connection” object (Instance ID 0x04) allows you to select either a “Change-of-state” (COS) or a “Cyclic” connection.

With “Change-of-state”, the gateway produces its data only when their values change or when a timer called “heartbeat rate” times out. A minimum time limit is intended to prevent the connection from monopolizing the DeviceNet network’s bandwidth, should the values of the data it produces change too often.

Going into “Cyclic” mode allows the number of exchanges made via this connection to be reduced if the update time (sampling) for the data produced is slow. By adjusting the connection’s cycle time to the value of this time, the produced data corresponds exactly to the data samples, without losing or repeating any sample.

WARNING

UNINTENDED OPERATION OF THE SYSTEM

You must configure the “Change-of-State / Cyclic Connection” object properly. Otherwise, it will affect the communication over the whole DeviceNet network, leading to the bus saturation and to the non transmission of data from other slaves.

Failure to follow this instruction may result in death, serious injury, or equipment damage.

Attributes of class 0x05

ID	Access	Name	Need	Type	Value	Description
0x01	Get	Revision	Optional	UINT	1	Revision index of the “Connection Object” class.
0x64	Get / Set	Polled production	Optional	USINT	0	Index of the input area used by the gateway for production on its “Polled Command/Response” connection.
0x65	Get / Set	Polled consumption	Optional	USINT	0	Index of the output area used by the gateway for consumption on its “Polled Command/Response” connection.
0x66	Get / Set	Strobed production	Optional	USINT	0	Index of the input area used by the gateway for production on its “Bit Strobed Command/Response” connection.
0x67	Get / Set	Strobed consumption	Optional	USINT	0	Index of the output area used by the gateway for consumption on its “Bit Strobed Command/Response” connection.
0x68	Get / Set	COS production	Optional	USINT	0	Index of the input area used by the gateway for production on its “Bit Strobed Command/Response” connection.

Services in class 0x05

Service code	Name of the service	Need	Description
0x0E	Get_Attribute_Single	Required	This service allows to read the value of one of the class attributes.

Attributes of instance 0x01 of class 0x05: Explicit Connection

ID	Access	Name	Need	Type	Value
0x01	Get	State	Required	USINT	0 to 5
	This attribute represents the status of the “Explicit Connection” object. The LUF9 gateway supports the following values: 0 (non-existent), 1 (in the process of being configured), 3 (connection established), 4 (timed out) and 5 (deferred deletion). Please see figures 5.16 and 7.4 in volume 1 of the DeviceNet specifications for further information on this subject.				
0x02	Get	Instance type	Required	USINT	0
	This attribute defines the instance’s connection type: Messaging connection (0) or I/O connection (1).				

Appendix D: DeviceNet Objects

ID	Access	Name	Need	Type	Value
0x03	Get / Set	Transport class trigger	Required	BYTE	0x83
		<p>This attribute defines the behaviour of the connection. In the case of the LUF9 gateway's "Explicit Connection" object, this attribute takes the value 0x83, broken down as follows: Bits 0-3 = 2#0011 Transport Class = Class 3. Bits 4-6 = 2#xxx..... Value ignored in the case of a data server. Bit 7 = 2#1 The gateway behaves as a data server responding to queries from a DeviceNet client.</p>			
0x04	Get / Set	Produced connection ID	Required	UINT	2#11•••xx xxxx
		<p>The value of this attribute is placed in the CAN protocol's Identifier Field when the connection goes into transmission mode (group 3 messages). The term "xx xxxx" represents the 6 bits of the address of the gateway's DeviceNet node. The term "••" represents the message ID. E.g. 0x070A = 2#111 0000 1010 (group 3 messages; ID of the messages = 4; Gateway located at address 10).</p>			
0x05	Get / Set	Consumed connection ID	Required	UINT	2#11•••xx xxxx
		<p>The value of this attribute corresponds to the content of the CAN protocol's Identifier Field for the messages the connection should receive (group 3 messages). The term "xx xxxx" represents the 6 bits of the address of the DeviceNet node. The term "••" represents the message ID. E.g. 0x0601 = 2#110 0000 0001 (group 3 messages; ID of the messages = 0; Producer located at address 1).</p>			
0x06	Get / Set	Initial comm. characteristics	Required	BYTE	0x21
		<p>This attribute defines the Group or Groups of Messages by which the productions and consumptions associated with the "Explicit Connection" object are carried out. Please see chapters 3-2. and 5-4.3.6. of volume I of the DeviceNet specifications for further details on this subject.</p>			
0x07	Get / Set	Produced connection size	Required	UINT	516
		<p>Maximum number of bytes which can be transmitted via this instance's connection.</p>			
0x08	Get / Set	Consumed connection size	Required	UINT	516
		<p>Maximum number of bytes which can be received via this instance's connection.</p>			
0x09	Get / Set	Expected packet rate	Required	UINT	10,000 (unit = 1 ms, per 10 ms step)
		<p>This attribute allows the gateway to evaluate the values of the <i>Transmission Trigger Timer</i> and the <i>Inactivity / Watchdog Timer</i> for exchanges made using the "Explicit Connection" object. Please see chapter 5-4.4. in volume I of the DeviceNet specifications for further information on this subject.</p>			
0x0C	Get / Set	Watchdog timeout action	Required	USINT	3
		<p>This attribute defines the action taken when the watchdog timer is triggered or when the connection is inactive. The various possible values are as follows: 0 (Transition to timed out), 1 (Auto Delete) and 3 (Deferred Delete).</p>			
0x0D	Get / Set	Produced connection path length	Required	UINT	0
		<p>Size of the USINT array of attribute 0x0E (produced connection path).</p>			
0x0E	Get / Set	Produced connection path	Required	USINT [...]	(empty path)
		<p>This attribute defines the local path (without MAC ID) of the gateway's DeviceNet object used to produce the connection's data. In the case of the current instance, there is no production path for the "Explicit Connection".</p>			
0x0F	Get / Set	Consumed connection path length	Required	UINT	0
		<p>Size of the USINT array of attribute 0x10 (consumed connection path).</p>			
0x10	Get / Set	Consumed connection path	Required	USINT [...]	(empty path)
		<p>This attribute defines the local path (without MAC ID) of the gateway's DeviceNet object used to receive the data consumed by the connection. In the case of the current instance, there is no consumption path for the "Explicit Connection".</p>			

Appendix D: DeviceNet Objects

Attributes of instance 0x02 of class 0x05: Polled Command/Response Connection

ID	Access	Name	Need	Type	Value
0x01	Get	State	Required	USINT	0 to 4
	This attribute represents the status of the "Polled Command/Response Connection" object. The LUF9 gateway supports the following values: 0 (non-existent), 1 (in the process of being configured), 3 (connection established) and 4 (timed out). Please see figures 5.16 and 7.4 in volume I of the DeviceNet specifications for further information on this subject.				
0x02	Get	Instance type	Required	USINT	1
	This attribute defines the instance's connection type: Messaging connection (0) or I/O connection (1).				
0x03	Get / Set	Transport class trigger	Required	BYTE	0x82
	This attribute defines the behaviour of the connection. In the case of the LUF9 gateway's "Polled Command/Response Connection" object, this attribute takes the value 0x82, broken down as follows: Bits 0-3 = 2#0010 Transport Class = Class 2. Bits 4-6 = 2#xxx..... Value ignored in the case of a data server. Bit 7 = 2#1 The gateway behaves as a data server responding to queries from a DeviceNet client.				
0x04	Get / Set	Produced connection ID	Required	UINT	2#0●● ●●xx xxxx
	The value of this attribute is placed in the CAN protocol's Identifier Field when the connection goes into transmission mode (group 1 messages). The term "xx xxxx" represents the 6 bits of the address of the gateway's DeviceNet node. The term "●● ●●" represents the message ID. E.g. 0x03CA = 2#011 1100 1010 (group 1 messages; ID of the messages = 15; Gateway located at address 10).				
0x05	Get / Set	Consumed connection ID	Required	UINT	2#10x xxxx x●●
	The value of this attribute corresponds to the content of the CAN protocol's Identifier Field for the messages the connection should receive (group 2 messages). The term "x xxxx x" represents the 6 bits of the address of the DeviceNet node. The term "●●" represents the message ID. E.g. 0x0455 = 2#100 0101 0101 (group 2 messages; ID of the messages = 5; Producer located at address 10).				
0x06	Get / Set	Initial comm. characteristics	Required	BYTE	0x01
	This attribute defines the Group or Groups of Messages by which the productions and consumptions associated with the "Polled Command/Response Connection" object are carried out. Please see chapters 3-2. and 5-4.3.6. of volume I of the DeviceNet specifications for further details on this subject.				
0x07	Get / Set	Produced connection size	Required	UINT	(size of the input area)
	Maximum number of bytes which can be transmitted via this instance's connection. The value of this attribute should be set to the size of the input area choosed using attribute 0x0E. With the LUF9 gateway's default configuration, the value of this attribute is set to 32, that is to say to the size of "Input1" area.				
0x08	Get / Set	Consumed connection size	Required	UINT	(size of the output area)
	Maximum number of bytes which can be received via this instance's connection. The value of this attribute should be set to the size of the output area choosed using attribute 0x10. With the LUF9 gateway's default configuration, the value of this attribute is set to 32, that is to say to the size of "Output1" area.				
0x09	Get / Set	Expected packet rate	Required	UINT	80 (unit = 1 ms, per 10 ms step)
	This attribute defines the periodicity of the exchanges made via the connections of this instance.				
0x0C	Get / Set	Watchdog timeout action	Required	USINT	0
	This attribute defines the action taken when the watchdog timer is triggered or when the connection is inactive. The various possible values are as follows: 0 (Transition to timed out), 1 (Auto Delete), 2 (Auto Reset) and 3 (Deferred Delete).				
0x0D	Get / Set	Produced connection path length	Required	UINT	6
	Size of the USINT array of attribute 0x0E (produced connection path).				

Appendix D: DeviceNet Objects

ID	Access	Name	Need	Type	Value
0x0E	Get / Set	Produced connection path	Required	USINT [...]	0x 20 04 24 64 30 03
<p>This attribute defines the local path (without MAC ID) of the gateway's DeviceNet object used to produce the connection's data. In the case of the current instance, the default production path for the "Polled Command/Response Connection" designates attribute 0x03 of instance 0x64 of class 0x04, that is to say the data from "Input1" area.</p> <p>NOTE: Changing the value of attribute 0x64 of instance 0x00 of class 0x04 ("Polled production" EDS parameter) has a direct influence on the value of the attribute presented here, as the corresponding connection path is changed to allow access to the selected input area. These changes should only be made using the EDS file supplied with the gateway.</p>					
0x0F	Get / Set	Consumed connection path length	Required	UINT	6
<p>Size of the USINT array of attribute 0x10 (consumed connection path).</p>					
0x10	Get / Set	Consumed connection path	Required	USINT [...]	0x 20 04 24 96 30 03
<p>This attribute defines the local path (without MAC ID) of the gateway's DeviceNet object used to receive the data consumed by the connection. In the case of the current instance, the default consumption path for the "Polled Command/Response Connection" designates attribute 0x03 of instance 0x96 of class 0x04, that is to say the data from "Output1" area.</p> <p>NOTE: Changing the value of attribute 0x65 of instance 0x00 of class 0x04 ("Polled consumption" EDS parameter) has a direct influence on the value of the attribute presented here, as the corresponding connection path is changed to allow access to the selected output area. These changes should only be made using the EDS file supplied with the gateway.</p>					

Attributes of instance 0x03 of class 0x05: Bit Strobed Command/Response Connection

ID	Access	Name	Need	Type	Value
0x01	Get	State	Required	USINT	0 to 4
<p>This attribute represents the status of the "Bit Strobed Command/Response Connection" object. The LUFF9 gateway supports the following values: 0 (non-existent), 1 (in the process of being configured), 3 (connection established) and 4 (timed out). Please see figures 5.16 and 7.4 in volume I of the DeviceNet specifications for further information on this subject.</p>					
0x02	Get	Instance type	Required	USINT	1
<p>This attribute defines the instance's connection type: Messaging connection (0) or I/O connection (1).</p>					
0x03	Get / Set	Transport class trigger	Required	BYTE	0x83
<p>This attribute defines the behaviour of the connection. In the case of the LUFF9 gateway's "Bit Strobed Command/Response Connection" object, this attribute takes the value 0x83, broken down as follows: Bits 0-3 = 2#0011 Transport Class = Class 3. Bits 4-6 = 2#xxx..... Value ignored in the case of a data server. Bit 7 = 2#1 The gateway behaves as a data server responding to queries from a DeviceNet client.</p>					
0x04	Get / Set	Produced connection ID	Required	UINT	2#0●●●●xx xxxx
<p>The value of this attribute is placed in the CAN protocol's Identifier Field when the connection goes into transmission mode (group 1 messages). The term "xx xxxx" represents the 6 bits of the address of the gateway's DeviceNet node. The term "●● ●●" represents the message ID. E.g. 0x038A = 2#011 1000 1010 (group 1 messages; ID of the messages = 14; Gateway located at address 10).</p>					
0x05	Get / Set	Consumed connection ID	Required	UINT	2#10x xxxx x●●●
<p>The value of this attribute corresponds to the content of the CAN protocol's Identifier Field for the messages the connection should receive (group 2 messages). The term "x xxxx x" represents the 6 bits of the address of the DeviceNet node. The term "●●●●" represents the message ID. E.g. 0x0400 = 2#100 0000 0000 (group 2 messages; ID of the messages = 0; Producer located at address 0).</p>					
0x06	Get / Set	Initial comm. characteristics	Required	BYTE	0x02
<p>This attribute defines the Group or Groups of Messages by which the productions and consumptions associated with the "Bit Strobed Command/Response Connection" object are carried out. Please see chapters 3-2. and 5-4.3.6. of volume I of the DeviceNet specifications for further details on this subject.</p>					

Appendix D: DeviceNet Objects

ID	Access	Name	Need	Type	Value
0x07	Get / Set	Produced connection size	Required	UINT	(size of the input area)
		Maximum number of bytes which can be transmitted via this instance's connection. The value of this attribute should be set to the size of the input area choosed using attribute 0x0E. With the LUF9 gateway's default configuration, the value of this attribute is set to 0, as no input area is assigned to the "Bit Strobed Command/Response Connection" object. Maximum size = 8 bytes.			
0x08	Get / Set	Consumed connection size	Required	UINT	(size of the output area)
		The value of this attribute is not significant in the case of the "Bit Strobed Command/Response Connection" object. This value is set to 8.			
0x09	Get / Set	Expected packet rate	Required	UINT	80 (unit = 1 ms, per 10 ms step)
		This attribute defines the periodicity of the exchanges made via the connections of this instance.			
0x0C	Get / Set	Watchdog timeout action	Required	USINT	0
		This attribute defines the action taken when the watchdog timer is triggered or when the connection is inactive. The various possible values are as follows: 0 (Transition to timed out), 1 (Auto Delete), 2 (Auto Reset) and 3 (Deferred Delete).			
0x0D	Get / Set	Produced connection path length	Required	UINT	0
		Size of the USINT array of attribute 0x0E (produced connection path).			
0x0E	Get / Set	Produced connection path	Required	USINT [...]	(area path)
		This attribute defines the local path (without MAC ID) of the gateway's DeviceNet object used to produce the connection's data. In the case of the current instance, the production path for the "Bit Strobed Command/Response Connection" corresponds to the input area assigned to the "Polled Command/Response Connection" using the "Strobed production" EDS parameter.			
0x0F	Get / Set	Consumed connection path length	Required	UINT	0
		Size of the USINT array of attribute 0x10 (consumed connection path).			
0x10	Get / Set	Consumed connection path	Required	USINT [...]	(area path)
		This attribute defines the local path (without MAC ID) of the gateway's DeviceNet object used to receive the data consumed by the connection. In the case of the current instance, the consumption path for the "Bit Strobed Command/Response Connection" corresponds to the output area assigned to this connection using the "Strobed consumption" EDS parameter.			

Attributes of instance 0x04 of class 0x05: Change-of-State / Cyclic (Acknowledged) Connection

ID	Access	Name	Need	Type	Value
0x01	Get	State	Required	USINT	0 to 4
		This attribute represents the status of the "Change-of-State / Cyclic (Acknowledged) Connection" object. The LUF9 gateway supports the following values: 0 (non-existent), 1 (in the process of being configured), 3 (connection established) and 4 (timed out). Please see figures 5.16 and 7.4 in volume I of the DeviceNet specifications for further information on this subject.			
0x02	Get	Instance type	Required	USINT	1
		This attribute defines the instance's connection type: Messaging connection (0) or I/O connection (1).			
0x03	Get / Set	Transport class trigger	Required	BYTE	0x12 or 0x02
		This attribute defines the behaviour of the connection. In the case of the LUF9 gateway's "Change-of-State / Cyclic (Acknowledged) Connection" object, this attribute takes the value 0x12 or 0x02, broken down as follows: Bits 0-3 = 2#0010 Transport Class = Class 2. Bits 4-6 = 2#001 or 2#000 "Change-of-State" mode (2#001) or "Cyclic" mode (2#000). Bit 7 = 2#0			

Appendix D: DeviceNet Objects

ID	Access	Name	Need	Type	Value
0x04	Get / Set	Produced connection ID	Required	UINT	2#0●● ●●xx xxxx
<p>The value of this attribute is placed in the CAN protocol's Identifier Field when the connection goes into transmission mode (group 1 messages). The term "xx xxxx" represents the 6 bits of the address of the gateway's DeviceNet node. The term "●● ●●" represents the message ID.</p> <p>E.g. 0x034A = 2#011 0100 1010 (group 1 messages; ID of the messages = 13; Gateway located at address 10).</p>					
0x05	Get / Set	Consumed connection ID	Required	UINT	2#10x xxxx x●●
<p>The value of this attribute corresponds to the content of the CAN protocol's Identifier Field for the messages the connection should receive (group 2 messages). The term "x xxxx x" represents the 6 bits of the address of the DeviceNet node. The term "●●" represents the message ID.</p> <p>E.g. 0x0452 = 2#100 0101 0010 (group 2 messages; ID of the messages = 2; Gateway located at address 10).</p>					
0x06	Get / Set	Initial comm. characteristics	Required	BYTE	0x01
<p>This attribute defines the Group or Groups of Messages by which the productions and consumptions associated with the "Change-of-State / Cyclic (Acknowledged) Connection" object are carried out. In this case, it designates groups 1 and 2. Please see chapters 3-2. and 5-4.3.6. of volume I of the DeviceNet specifications for further details on this subject.</p>					
0x07	Get / Set	Produced connection size	Required	UINT	(size of the input area)
<p>Maximum number of bytes which can be transmitted via this instance's connection. The value of this attribute should be set to the size of the input area choosed using attribute 0x0E. With the LUFFP9 gateway's default configuration, the value of this attribute is set to 0, as no input area is assigned to the "Change-of-State / Cyclic (Acknowledged) Connection" object.</p>					
0x08	Get / Set	Consumed connection size	Required	UINT	0
<p>Maximum number of bytes which can be received via this instance's connection. As the LUFFP9 gateway does not consume any data via this connection, the value of this attribute will remains set to 0.</p>					
0x09	Get / Set	Expected packet rate	Required	UINT	0 (unit = 1 ms, per 10 ms step)
<p>This attribute defines the periodicity of the exchanges made via the connections of this instance.</p>					
0x0C	Get / Set	Watchdog timeout action	Required	USINT	0
<p>This attribute defines the action taken when the watchdog timer is triggered or when the connection is inactive. The various possible values are as follows: 0 (Transition to timed out), 1 (Auto Delete), 2 (Auto Reset) and 3 (Deferred Delete).</p>					
0x0D	Get / Set	Produced connection path length	Required	UINT	0
<p>Size of the USINT array of attribute 0x0E (produced connection path).</p>					
0x0E	Get / Set	Produced connection path	Required	USINT [...]	(area path)
<p>This attribute defines the local path (without MAC ID) of the gateway's DeviceNet object used to produce the connection's data. In the case of the current instance, the production path for the "Change-of-State / Cyclic (Acknowledged) Connection" corresponds to the output area assigned to this connection using the "COS production" EDS parameter.</p>					
0x0F	Get / Set	Consumed connection path length	Required	UINT	4
<p>Size of the USINT array of attribute 0x10 (consumed connection path).</p>					
0x10	Get / Set	Consumed connection path	Required	USINT [...]	(area path)
<p>This attribute defines the local path (without MAC ID) of the gateway's DeviceNet object used to receive the data consumed by the connection. In the case of the current instance, the consumption path for the "Change-of-State / Cyclic (Acknowledged) Connection" designates instance 0x01 of class 0x2B, that is to say the only object of the "Acknowledge Handler Object" class.</p> <p>NOTE: The EDS file supplied with the gateway does not contain any parameter whose modification would have had any influence on the value of this attribute.</p>					

Appendix D: DeviceNet Objects

Attributes of instances 0x01 to 0x04 of class 0x05

Service code	Name of the service	Need	Description
0x0E	Get_Attribute_Single	Required	This service allows to read the value of one of the attributes from one of the instances of the "Connection Object."
0x10	Set_Attribute_Single	Optional	This service allows to write the value of one of the attributes from one of the instances of the "Connection Object."

Acknowledge Handler Object (class 0x2B)

The "Acknowledge Handler" object has only one instance (Instance ID = 0x01). This object is used by connections whose producer needs to know whether its data has been received by its recipient(s) (consumers). This object is described in chapter 6-31. of volume II of the DeviceNet specifications.

Attributes of class 0x2B

ID	Access	Name	Need	Type	Value	Description
0x01	Get	Revision	Optional	UINT	1	Revision index of the "Acknowledge Handler Object" class.
0x02	Get	Max instance	Optional	UINT	1	Maximum number of any instance created within the "Acknowledge Handler Object" class.

Services in class 0x2B

Service code	Name of the service	Need	Description
0x0E	Get_Attribute_Single	Required	This service allows to read the value of one of the attributes of the class.

Attributes of instance 0x01 of class 0x2B

ID	Access	Name	Need	Type	Value
0x01	Get / Set	Acknowledge timer	Required	UINT	20 (unit: 1ms)
	The value of this attribute determines the waiting time for acknowledgement of the message from a connection. Once this time has elapsed, the gateway proceeds to re-transmit the message which has just failed to be acknowledged. The value of this attribute ranges from 1 to 65,535, and its default value is 20.				
0x02	Get / Set	Retry limit	Required	USINT	1
	This attribute determines the maximum number of times that the acknowledge timeout can be successively triggered for the same message, and therefore the number of re-transmissions allowed for each message. The value of this attribute ranges from 0 to 255, and its default value is 1.				
0x03	Get / Set	COS producing connection instance	Required	UINT	4
	The value of this attribute is set to the instance number (Instance ID) of the "Connection Object" class corresponding to the "Change-of-State" connection associated with the "Acknowledge Handler" object. This association allows the latter to transmit the acknowledgements it receives to the corresponding connection if they are addressed to it.				
0x04	Get	Ack list size	Optional	BYTE	1
	This attribute represents the maximum number of members which can be placed in the ack list. If the value of this attribute is null, the size of the list is dynamic, which is not the case with the LUF9 gateway.				
0x05	Get	Ack list	Optional	BYTE , USINT [...]	0 , (empty list)
	This attribute corresponds to the list of active instances of the "Connection Object" class for which the receipt of an acknowledgement is required. It is made up of two elements: The number of members (BYTE) and the list of the associated instance numbers from the "Connection Object" class (USINT [...]). The size of the list is set to the value of the first element. By default, the list is empty (no term of the USINT type [...]) and only the BYTE element is created. E.g. "1, 4" for a list comprising a single instance of the "Connection Object" class. This instance (0x04) corresponds to the "Change-of-State / Cyclic (Acknowledged) Connection".				

Appendix D: DeviceNet Objects

ID	Access	Name	Need	Type	Value
0x06	Get	Data with ack path list size	Optional	BYTE	1
This attribute represents the maximum number of members which can be placed in the data with ack path list. If the value of this attribute is null, the size of the list is dynamic, which is not the case with the LUFP9 gateway.					
0x07	Get	Data with ack path list	Optional	BYTE, (UINT, USINT, USINT [...]) [...]	(data with ack path list)
<p>This attribute corresponds to the list of “connection instance / consuming application object” pairs allowing the data received in an acknowledgement to be forwarded. An acknowledgement does not necessarily contain any data and so this attribute is optional. It is made up of the following elements:</p> <ul style="list-style-type: none"> • The number of members of the list (BYTE). • The list of “connection instance / consuming application object” pairs (UINT , USINT, USINT [...]) [...]. The size of this list is set to the value of the first element, described above, and this list is made up of the following elements: <ul style="list-style-type: none"> - The acknowledged COS consuming connection instance number (UINT). - The path length of the DeviceNet object intended to receive the acknowledgement data (USINT). - The path of the DeviceNet object intended to receive the acknowledgement data (USINT [...]). <p>E.g. 0x 01 00 04 06 20 04 24 98 30 01. The value of this attribute means that this list only contains a single element (0x01) referring to instance 0x0004 and that the acknowledgement data path (0x06: length 6 bytes) refers to attribute 0x01 of instance 0x98 of class 0x04, that is to say to data from output area no. 1, that is to say “Output1.”</p>					

Services of instance 0x01 of class 0x2B

Service code	Name of the service	Need	Description
0x0E	Get_Attribute_Single	Required	This service allows to read the value of the single instance from the “Acknowledge Handler Object.”
0x10	Set_Attribute_Single	Required	This service allows to write the value of the single instance from the “Acknowledge Handler Object.”

Appendix D: DeviceNet Objects

I/O Data Input Mapping Object (Class 0xA0)

The “I/O Data Input Mapping Object” has only one instance (Instance ID = 0x01) and is specific to the LUFF9 gateway. It contains all the data from the gateway’s unique input area. The only attribute (Attribute ID = 0x01) of the instance from this object is associated with the “Input1” area. This input area gathers all the memory locations receiving data from a Modbus response.

Attributes of class 0xA0

ID	Access	Name	Need	Type	Value	Description
0x01	Get	Revision	Optional	UINT	1	Revision index of “I/O Data Input Mapping Object” class.
0x64	Get / Set	Input1 offset	Optional	USINT	0x0000	Relative starting address of input area no. 1. (1)
0x6E	Get / Set	Input1 length	Optional	USINT	0x0020	Size, expressed in bytes, of input area no. 1. (1)

- (1) These 2 attributes correspond to the “Param6” and “Param7” parameters referenced by the EDS file supplied with the gateway. Write access to them (Access = Set) is reserved for DeviceNet configuration tools, since it allows you to change the location or the size of this input data area. So the “Set_Attribute_Single” service should not be used with these attributes. Changing any one of these two attributes has direct consequences on the attribute 0x01 of instance 0x01 from the “I/O Data Input Mapping Object” (size of the data). This attribute is not created if the size of the gateway’s input area is null. The “Input1 offset” attribute corresponds to an offset from the start of the memory area reserved for the input data (0x0000).

The values located in the “Value” column correspond to the LUFF9 gateway’s default configuration (“Input1” area located at address 0x0000 and made up of 32 bytes).

Services in class 0xA0

Service code	Name of the service	Need	Description
0x0E	Get_Attribute_Single	Required	This service allows to read the value of one of the class attributes.

Attributes of instance 0x01 of class 0xA0

ID	Access	Name	Need	Type	Value
0x01	Get	Data	Optional	USINT [...]	(input area no.1)
This attribute corresponds to the gateway’s “Input1” area. Reading it gives access to the values of all the data located in this area in the form of an array of bytes whose size corresponds to the size of the area. This very same attribute is also involved when using instance Assembly Objects described in Appendix D: DeviceNet Objects. NOTE: With the default configuration, attribute 0x01 corresponds to an array of 32 bytes whose content is described in Appendix B., Input Data Memory Area.					

Services of instance 0x01 of class 0xA0

Service code	Name of the service	Need	Description
0x0E	Get_Attribute_Single	Required	This service allows to read the array of values corresponding to the sole attribute of the single instance from “I/O Data Input Mapping Object”.

Appendix D: DeviceNet Objects

I/O Data Output Mapping Object (Class 0xA1)

The “I/O Data Output Mapping Object” has only one instance (Instance ID = 0x01) and is specific to the LUFF9 gateway. It contains all the data from the gateway’s unique output area. The only attribute (Attribute ID = 0x01) of the instance from this object is associated with the “Output1” area. This output area gathers all the memory locations whose values are transmitted to the Modbus slaves via Modbus queries.

Attributes of class 0xA1

ID	Access	Name	Need	Type	Value	Description
0x01	Get	Revision	Optional	UINT	1	Revision index of “I/O Data Output Mapping Object” class.
0x64	Get / Set	Output1 offset	Optional	USINT	0x0000	Relative starting address of output area no. 1. (1)
0x6E	Get / Set	Output1 length	Optional	USINT	0x0020	Size, expressed in bytes, of output area no. 1. (1)

- (1) These 2 attributes correspond to the “Param18” and “Param19” parameters referenced by the EDS file supplied with the gateway. Write access to them (Access = Set) is reserved for DeviceNet configuration tools, since it allows you to change the location or the size of this output data area. So the “Set_Attribute_Single” service should not be used with these attributes. Changing any one of these two attributes has direct consequences on the attribute 0x01 of instance 0x01 from the “I/O Data Output Mapping Object” (size of the data). This attribute is not created if the size of the gateway’s output area is null. The “Output1 offset” attribute corresponds to an offset from the start of the memory area reserved for the output data (0x0200).

The values located in the “Value” column correspond to the LUFF9 gateway’s default configuration (“Output1” area located at address 0x0200 and made up of 32 bytes).

Services in class 0xA1

Service code	Name of the service	Need	Description
0x0E	Get_Attribute_Single	Required	This service allows to read the value of one of the class attributes.

Attributes of instance 0x01 of class 0xA1

ID	Access	Name	Need	Type	Value
0x01	Get / Set	Data	Optional	USINT [...]	(output area no.1)
<p>This attribute corresponds to the gateway’s “Output1” area. Reading it gives access to the values of all the data located in this area, and writing it allows to change them. These values take the form of an array of bytes whose size corresponds to the size of the area. This very same attribute is also involved when using instance 0x96 of the Assembly Objects described in Appendix D: DeviceNet Objects.</p> <p>NOTE: With the default configuration, attribute 0x01 corresponds to an array of 32 bytes whose content is described in Appendix B:, Output Data Memory Area.</p>					

Services of instance 0x01 of class 0xA1

Service code	Name of the service	Need	Description
0x0E	Get_Attribute_Single	Optional	This service allows to read the array of values corresponding to the sole attribute of the single instance from “I/O Data Output Mapping Object.”
0x10	Set_Attribute_Single	Required	This service allows to write/change all the values corresponding to the sole attribute of the single instance from “I/O Data Output Mapping Object.”

Appendix D: DeviceNet Objects

Diagnostic Object (Class 0xAA)

The “Diagnostic Object” has only one instance (Instance ID = 0x01) and is specific to the LUFFP9 gateway. It contains a large amount of diagnostic data of all levels. As a result, some of these diagnoses should not be used, as these are reserved for maintenance operations carried out on the gateway or when developing its software. However, the attributes to which they correspond are all described below for the sake of completeness.

Attributes of class 0xAA

ID	Access	Name	Need	Type	Value	Description
0x01	Get	Revision	Optional	UINT	1	Revision index of the “Diagnostic Object” class.

Services in class 0xAA

Service code	Name of the service	Need	Description
0x0E	Get_Attribute_Single	Required	This service allows to read the value of one of the class attributes.

Attributes of instance 0x01 of class 0xAA

ID	Access	Name	Need	Type	Value
0x01	Get	DeviceNet module serial number	Optional	UDINT	(variable)
		The value of the “DeviceNet module serial number” corresponds to the serial number of the gateway’s <i>AnyBus-S DeviceNet</i> card, that is to say the card on which the block of selector switches and the DeviceNet connector are located. e.g. 0x 20 DD 00 23.			
0x02	Get	Vendor ID	Optional	UINT	0x0001
		The value of this attribute is set to 0x0001 for the LUFFP9 gateway. The value 0x0000 cannot be used and values between 0x0002 and 0xFFFF are reserved for the gateway suppliers.			
0x03	Get	Fieldbus type	Optional	UINT	0x0025
		With the LUFFP9 gateway, this attribute always takes the same value (0x0025), as it characterizes the DeviceNet network. Any other value would be incorrect (e.g. 0x0001 for a Profibus-DP network).			
0x04	Get	DeviceNet module software version	Optional	UINT	0x0105
		This attribute shows the software version on the gateway’s <i>AnyBus-S DeviceNet</i> card. The major index of this version is given by the most significant byte and its minor index is given by the least significant byte, both in BCD format. e.g. 0x0105 corresponds to version 01.05.			
0x05	Get	Interrupt count	Optional	UINT	(counter)
		The value of the “interrupt count” is incremented by one every time an interrupt related to the management of the downstream Modbus network do occur.			
0x06	Get	Watchdog counter in	Optional	UINT	0x0000
		This counter is not implemented, and using this attribute is pointless. The primary function of this counter is to provide <i>feedback</i> from the lifetime counter represented by attribute 0x07, which would allow the <i>AnyBus-S DeviceNet</i> card to ensure that the card to which it is connected is working properly by comparing the values of these two attributes.			
0x07	Get	Watchdog counter out	Optional	UINT	(counter)
		The value of this counter is incremented by one every millisecond (at least one writing operation every 50 ms) and operates as an internal presence counter, intended to the gateway’s applicative card, that is to say the card on which the <i>AnyBus-S DeviceNet</i> card is inserted.			
0x08	Get	Access method status	Optional	USINT [4]	0x 40 00 00 80
		This array of 4 USINT elements determines the status of the method used to access the gateway’s memory’s general areas. This attribute is not relevant when using the gateway.			

Appendix D: DeviceNet Objects

ID	Access	Name	Need	Type	Value
0x09	Get	LED status	Optional	USINT [6]	(variable)
	The values of the elements of this attribute correspond to the status of the gateway's 6 LEDs (1 byte per LED). The first byte corresponds to LED ①, the second to LED ②, etc., up to LED ⑥. Each byte takes one of the following values to designate the state of the LED to which it corresponds: 0x00 (LED is off), 0x01 (LED is green) or 0x02 (LED is red).				
0x0A	Get	Module type	Optional	UINT	0x0101
	The value of this attribute is always equal to 0x0101 with the LUF9 gateway, as this is an "AnyBus-S" module.				
0x0B	Get	DeviceNet module status	Optional	USINT	(8-bit register)
	Reading this attribute's bits shows certain information about the state of the gateway's <i>AnyBus-S DeviceNet</i> card. The four data bits of these registers are described below: Bit 0: Gateway off-line (0) / on-line (1) on the DeviceNet network. Bit 1: All outputs are zeroed (0) or held (1) in the output memory area if the gateway is off-line on the DeviceNet network. Bit 8: All inputs are zeroed (0) or held (1) in the input memory area if the gateway's application is stopped. Bit 9: The "changed data field" register is inhibited (0) / activated (1).				
0x0C	Get	Changed data field	Optional	LWORD	—
	Each bit of this 64-bit register indicates whether the content of 8 consecutive bytes of the output memory area has been changed. Bit 0 relates to bytes 0x0200 to 0x0207, bit 1 relates to bytes 0x0208 to 0x0215, etc., up to bit 63, which relates to bytes 0x03F8 to 0x03FF.				
0x0D	Get	Interrupt cause	Optional	BYTE	(8-bit register)
	This register allows you to determine the cause of the last interrupt. Each bit is activated when the associated event occurs, then it is reset by the gateway's interrupt handler. So this register is not intended to be used by the DeviceNet master. Bit 0: The gateway goes on-line on the DeviceNet network. Bit 1: The gateway goes off-line on the DeviceNet network. Bit 2: Data changed.				
0x0E	Get	Interrupt notification	Optional	BYTE	(8-bit register)
	This register allows you to determine what types of interrupts are allowed (see description of attribute 0x0D). Its value is set when the gateway is initialized, using a specific mailbox (not described in this guide). Bit 0: Issuing an interrupt when the gateway goes on-line on the DeviceNet network. Bit 1: Issuing an interrupt when the gateway goes off-line on the DeviceNet network. Bit 2: Issuing an interrupt when the data are modified. To do this the "change data field" register should be activated (see description of bit 9 of attribute 0x0B).				
0x0F	Get	IN cyclic I/O length	Optional	UINT	0x0020
	This attribute indicates the total size of the cyclic input data (<i>I/O IN data</i>), expressed as a number of bytes. This size covers all the gateway's memory space occupied by Modbus input data, free locations also being counted. With the LUF9 gateway's default configuration, the value of this attribute corresponds to the size of the input area of the gateway, that is to say 32 bytes.				
0x10	Get	IN DPRAM length	Optional	UINT	0x0020
	This attribute indicates the total size of the input data and parameters in the gateway's memory (<i>valid IN bytes in DPRAM</i>), expressed as a number of bytes. This size covers all of the gateway's memory space occupied by Modbus input data and parameters, free locations also being counted. Since no input parameters are defined, the values of attributes 0x0F and 0x10 are both identical. With the LUF9 gateway's default configuration, the value of this attribute is equal to 32 bytes.				

Appendix D: DeviceNet Objects

ID	Access	Name	Need	Type	Value
0x11	Get	IN total length	Optional	UINT	0x0020
		<p>This attribute indicates the total size of the input data used in the gateway's extended memory (<i>IN bytes supported</i>), expressed as a number of bytes. This size is equal to the value of the previous attribute (size of inputs in DPRAM), as it only contains input data. The values of attributes 0x0F, 0x10 and 0x11 are all identical. With the LUF9 gateway's default configuration, the value of this attribute is equal to 32 bytes.</p> <p>NOTE: The gateway's extended internal memory is different from the DPRAM memory, dealt with in the rest of this guide. As a result, when using the gateway, you will not have to worry about it.</p>			
0x12	Get	OUT cyclic I/O length	Optional	UINT	0x0020
		<p>This attribute indicates the total size of the cyclic output data (<i>I/O OUT data</i>), expressed as a number of bytes. This size covers all the gateway's memory space occupied by Modbus output data, free locations also being counted. With the LUF9 gateway's default configuration, the value of this attribute corresponds to the size of the output area of the gateway, that is to say 32 bytes.</p>			
0x13	Get	OUT DPRAM length	Optional	UINT	0x0020
		<p>This attribute indicates the total size of the output data and parameters in the gateway's memory (<i>valid OUT bytes in DPRAM</i>), expressed as a number of bytes. This size covers all of the gateway's memory space occupied by Modbus output data and parameters, free locations also being counted. Since no output parameters are defined, the values of attributes 0x12 and 0x13 are both identical. With the LUF9 gateway's default configuration, the value of this attribute is equal to 32 bytes.</p>			
0x14	Get	OUT total length	Optional	UINT	0x0020
		<p>This attribute indicates the total size of the output data used in the gateway's extended memory (<i>OUT bytes supported</i>), expressed as a number of bytes. This size is equal to the value of the previous attribute (size of outputs in DPRAM), as it only contains output data. The values of attributes 0x12, 0x13 and 0x14 are all identical. With the LUF9 gateway's default configuration, the value of this attribute is equal to 32 bytes.</p> <p>NOTE: The gateway's extended internal memory is different from the DPRAM memory, dealt with in the rest of this guide. As a result, when using the gateway, you will not have to worry about it.</p>			
0x15	Get	Reserved attribute	Optional	UINT	0x0000
		This attribute is not used.			
0x16	Get	Application indication	Optional	USINT	(8-bit register)
		<p>This 8-bit register is reserved for the gateway's applicative card, that is to say the card on which the <i>AnyBus-S DeviceNet</i> card is inserted. The various bits of this register are primarily used when internal commands of the gateway are intended to act on the gateway's memory. These bits are not intended to be used by the DeviceNet master and will not be described here.</p>			
0x17	Get	AnyBus indication	Optional	USINT	(8-bit register)
		<p>This 8-bit register is reserved for the gateway's <i>AnyBus-S DeviceNet</i> card. The various bits of this register are primarily used when internal commands of the gateway are intended to act on the gateway's memory. These bits are not intended to be used by the DeviceNet master and will not be described here, except for bit 4:</p> <p>Bit 4: This bit is set to one once the gateway's <i>AnyBus-S DeviceNet</i> card has been initialized.</p>			

Services of instance 0x01 of class 0xAA

Service code	Name of the service	Need	Description
0x0E	Get_Attribute_Single	Required	This service allows to read the value of the single instance of the "Diagnostic Object."

Appendix E: Modbus Commands

Only the Modbus commands shown in the right-hand table are supported by the gateway. The structure of the query and response frames for each of these commands is then described in the following chapters.

Function code		Broadcast (1)	Modbus command
3	0x03	—	Read Holding Registers
6	0x06	Yes	Preset Single Register
16	0x10	Yes	Preset Multiple Registers

- (1) The content of this column shows whether the command can be added (“Yes”) or not (“—”) to the list of a broadcaster node’s commands, known as “Broadcaster” in ABC-LUFP Config Tool.

In the following chapters, each byte of the query and response frames of a Modbus command are described, one after another, with the exception of the fields shown opposite. These are always present in the queries and responses of all Modbus commands.

The “Slave Address” and “Function” fields are the first two bytes of these frames. The two bytes of the “Checksum” are their last two bytes.

Slave Address	- Value cannot be changed (Modbus address: 1 to 247. Addresses 65, 126, and 127 reserved)
Function	- Value cannot be changed (code of the Modbus command)
... Other fields Specific features of Modbus commands ...
Checksum (Lo)	- Type of error check
Checksum (Hi)	- Number of the 1st byte checked

The descriptions of the Modbus frames which appear in the following chapters are mainly intended to help you to configure the gateway’s Modbus exchanges using ABC-LUFP Config Tool. Please see the documentation of each Modbus slave to check for any restriction regarding these frames (number of registers which can be read or written in a single Modbus command, for example).

It is a better idea to get hold of a standard Modbus document, such as the guide entitled *Modicon Modbus Protocol Reference Guide* (ref.: PI-MBUS-300 Rev. J), so that you can see the correspondence between the elements displayed in ABC-LUFP Config Tool and the content of the corresponding Modbus frames. Here is an example of a correspondence for a full frame (including the start and end of frame fields shown above), based on the Read Holding Registers Command.

	Modbus Frame Fields	Elements under ABC-LUFP Config Tool	Size
Modbus Query	Slave Address	Slave Address	1 byte
	Function Code	Function Code	1 byte
	Starting Register Address (Hi, Lo)	Starting Address	2 bytes
	Number of points (Hi, Lo)	Quantity of Registers	2 bytes
	Checksum	CRC16	2 bytes
Modbus Response	Slave Address	Slave Address	1 byte
	Function Code	Function Code	1 byte
	Byte count	Byte Count	1 byte
	Data	First Register Value	2 bytes
	
		Last Register Value	2 bytes
Checksum	CRC16	2 bytes	

Appendix E: Modbus Commands

Chapter 6.11 Adding and Setting Up a Modbus Command also shows a few examples of correspondences between the elements displayed in ABC-LUFP Config Tool and the corresponding Modbus frame fields.

See also: Chapter 6.11.2 With a Generic Modbus Slave, and chapter 6.11.3 Adding a Special Modbus Command, if the implementation of one of these commands would be incompatible with its implementation in the gateway, for example. You then have to create a special Modbus command to compensate for this incompatibility.

“Read Holding Registers” Command (0x03)

Frame	ABC-LUFP Config Tool field	Value or properties
Query	Starting Register Address	- Address of the register
	Number of Registers	- Number of registers
	Checksum	- CRC16
Response	Byte Count	- Number of data bytes = number of registers × 2
	Data (first register)	- Byte swap = “Swap 2 bytes”
	- Data length = Value of the “Byte count” field
	Data (last register)	- Data location = Address in the gateway’s input memory
	Checksum	- CRC16

“Preset Single Register” command (0x06)

Frame	ABC-LUFP Config Tool field	Value or properties
Query	Register Address	- Address of the register
	Preset Data	- Byte swap = “Swap 2 bytes” - Data length = 0x0002 - Data location = Address in the gateway’s output memory
Response	Register Address	- Byte swap = “Swap 2 bytes”
	Preset data	- Data length = 0x0002 - Data location = Address in the gateway’s input memory
	Checksum	- CRC16

NOTE: As the slave response is the echo of the request, you do not have to load it to the DeviceNet scanner’s level.

Appendix E: Modbus Commands

“Preset Multiple Registers” Command (0x10)

Frame	ABC-LUFP Config Tool field	Value or properties
Query	Starting Register Address	- Address of the 1st register
	Number of Registers	- Number of registers
	Byte Count	- Number of data bytes = number of registers × 2
	Data (first register)	- Byte swap = “Swap 2 bytes”
	- Data length = Value of the “Byte count” field
	Data (last register)	- Data location = Address in the gateway’s output memory
	Checksum	- CRC16
Response	Starting Register Address	- Address of the 1st register
	Number of Registers	- Number of registers
	Checksum	- CRC16

Modbus Protocol Exception Responses

When it cannot process a command dictated by a Modbus query, a slave sends an exception response instead of the normal response to the query.

⚠ WARNING
UNATTENDED OPERATION OF THE SYSTEM
<p>With standard Modbus commands, the LUFP9 gateway considers that all exception responses which it receives from Modbus slaves are incorrect responses. As a result, it will carry out the re-transmissions configured for the queries involved.</p> <p>If you want the software application for your DeviceNet master to be able to specifically manage exception responses, you can replace the Modbus command, in ABC-LUFP Config Tool, with a personalized command (see chapter 6.11.3.2 User-Customizable Modbus Commands). This then allows you to feed back the “Slave Address” and “Function” fields to the DeviceNet master.</p> <p>Failure to follow this instruction may result in death, serious injury, or equipment damage.</p>

The structure of an exception response is independent of the Modbus command associated with the “Function” field of the query involved. The whole frame of an exception response is shown below:

Slave Address	Modbus address (1 to 247; addresses 65, 126 and 127 reserved): The value of this field is identical to that of the “Slave Address” field of the query involved.
Function	Command code, with exception indicator: The value of this field is set to 0x80 + the value of the “Function” field of the query involved.
Exception Code	Code indicating the nature of the error which has caused the exception response (see table on next page).
Checksum (Lo)	Error check
Checksum (Hi)	

Appendix E: Modbus Commands

Code	Name of the exception	Description of the exception
0x01	ILLEGAL FUNCTION	The query's "Function" command code is not implemented in the Modbus slave software, or it is unable to process it for the moment.
0x02	ILLEGAL DATA ADDRESS	The combination of the query's "Starting Address" and "No. of Registers" fields (or assimilated fields) gives access to one or more addresses which are not accessible on the Modbus slave.
0x03	ILLEGAL DATA VALUE	The value of one of the Modbus query's fields is outside the authorized limits. This error does not affect the content of the "Data" (or assimilated) fields, as this error only takes account of the fields used for managing the Modbus protocol.
0x04	SLAVE DEVICE FAILURE	An unrecoverable failure has occurred when processing the command.
0x05 (1)	ACKNOWLEDGE	The Modbus slave informs the gateway that it has accepted the command (acknowledgement), but that it will take too long to process it and it cannot afford to wait for the completion of this process before sending a response. The gateway should transmit subsequent queries in order to determine whether the command has finished or not.
0x06 (1)	SLAVE DEVICE BUSY	The Modbus slave informs the gateway that it is already in the process of running a command and therefore it cannot run the one transmitted to it. So the gateway should re-transmit the query subsequently.
0x07 (1)	NEGATIVE ACKNOWLEDGE	The Modbus slave informs the gateway that it cannot process the requested command. This exception only affects commands 13 and 14 (0x0D and 0x0E). These functions are not part of the standard Modbus commands and are not described in this document.
0x08 (1)	MEMORY PARITY ERROR	The Modbus slave informs the gateway that it has detected a parity error on the access to its own memory. This exception only affects standard commands 20 and 21 (0x14 and 0x15) which are not supported by the gateway.

(1) Please see the standard Modbus documentation for further information about these various cases.

Index

- 2**
2-way TSXSCA62 subscriber connector, 18
- A**
Address, 21
Allen Bradley
 SLC500, 37
Architecture, 8, 25
- C**
Communication speed, 20
Communications
 aperiodic, 35, 36, 37
 periodic, 35, 36, 37
Cycle time, 26
- D**
Data exchanged, 10
DeviceNet master PLC, 31
DeviceNet scanner, 34
DeviceNet slave, 9
Diagnostic LEDs, 11
DIN Rail, 12
- E**
EDS file, 31
- L**
LEDs, 23
Line resistance, 19
LU9GC03 hub, 18
- M**
MAC ID address, 32
Modbus cable, 18
Modbus slaves, 8, 9
- P**
Parameters, 32
Protective Earth, 12
- R**
Related documents, 5
RJ45 connector, 11, 16
RSLogix 500, 37
RSNetWorx, 35, 36
- S**
Selector switch, 20
SLC500, 37
- T**
Tap boxes, 16
Topology
 bus, 15
 star, 13
TSXCA50 tap box, 18
- V**
VW3 A68 306 cable, 16
VW3 A8 306 RC double termination, 18
VW3 A8 306 TF3 drop box, 18

Glossary

0x****	Value expressed in hexadecimal, which is equivalent to the H****, ****h and 16#**** notations, sometimes used in other documents. NOTE: The ABC-LUFP Config Tool software uses the 0x**** notation. E.g. 0x0100 = 16#0100 = 256.
02#**** ****	Value expressed in binary. The number of ‘.’ digits depends on the size of the item of data represented. Each nibble (group of 4 bits) is separated from the other nibbles by a space. E.g. byte 2#0010 0111 = 39, word 2#0110 1001 1101 0001 = 0x69D1 = 27089.
ABC-LUFP Config Tool	Abbreviation that refers to the AnyBus Communicator tool used to configure and implement the LUFP9 gateway. Also found as ‘ABC-LUFP Configurator’.
“ABC” element	ABC-LUFP Configurator element that can be of an input or an output data type.
ATS	Abbreviation of “Altistart” (soft start- soft stop unit).
ATV	Abbreviation of “Altivar” (drive).
Control/Status byte	ABC-LUFP Configurator field.
CRC	Cyclical Redundancy Check.
EDS	Electronic Data Sheet. Refers to the file format (“.eds” extension) which allow a tool used for configuring and preparing DeviceNet masters to configure their exchanges using this same protocol.
Fieldbus	A term referring to the upstream DeviceNet network in ABC-LUFP Config Tool.
Handshake	An old term referring to the two registers used for initializing and carrying out diagnostics of the LUFP9 gateway. This term has been replaced by the expression “Control/Status Byte”.
LED	Light-Emitting Diode.
LRC	Longitudinal Redundancy Check.
LSB	Least significant byte in a 16-bit word.
MAC ID	Media Access Control ID. Address of a module on a DeviceNet bus.
MSB	Most significant byte in a 16-bit word.
Node	A term referring to the connection point of a Modbus slave under ABC-LUFP Config Tool.
ODVA	Open DeviceNet Vendor Association, Inc.
Sub-Network	A term referring to the downstream Modbus network under ABC-LUFP Config Tool.
XML	EXtensible Markup Language. The language used by ABC-LUFP Config Tool to import/export the configuration of a Modbus slave.

