

Mini Horns Sirens Buzzer / Horn 585

Signal horn WM Contin. tone 230VAC GY

Part No.: 585.000.68

**MECHANICAL DATA**

Length	91 mm
Width	83 mm
Height	84 mm
Diameter	83 mm
Materials	PC PC/ABS
Housing colour	Grey
Protection category	IP65
Connection	Screw terminals
cross-sectional area maximum	1,50mm ² / 16AWG
Cable entry	Membrane grommet
Cable entry minimum	d = 1 mm
Cable entry maximum	d = 9 mm
Tension relief	Pull-out protection
Type of fixing	Wall mounting
Acoustic service life	5,000 h minimum
Working temperature minimum	-20°C
Working temperature maximum	+50°C
Weight with packaging	147 g
Product weight	113 g

ELECTRICAL DATA

Operating voltage	230V
Operating voltage type	AC
Operating voltage frequency	50Hz
Operating voltage tolerance	+/- 10%
Rated operational voltage	230 VAC
Rated operational current	70 mA
Rated inrush current	1.000 mA
Protection class	Protection class 2
Pollution degree	3
Overvoltage category	II
Isolation voltage	Ui = 250V; Uimp = 2.500V

ACUSTICAL DATA

Volume/dB(max) at 1m distance	98,0 dB (A)
Acoustic signal image	Continuous tone
Audio frequency	110 Hz



For additional installation and mounting information, refer to the appropriate user guide at www.werma.com. This printed copy is for information only and is subject to alteration.

Mini Horns Sirens Buzzer / Horn 585

Signal horn WM Contin. tone 230VAC GY

DRAWING

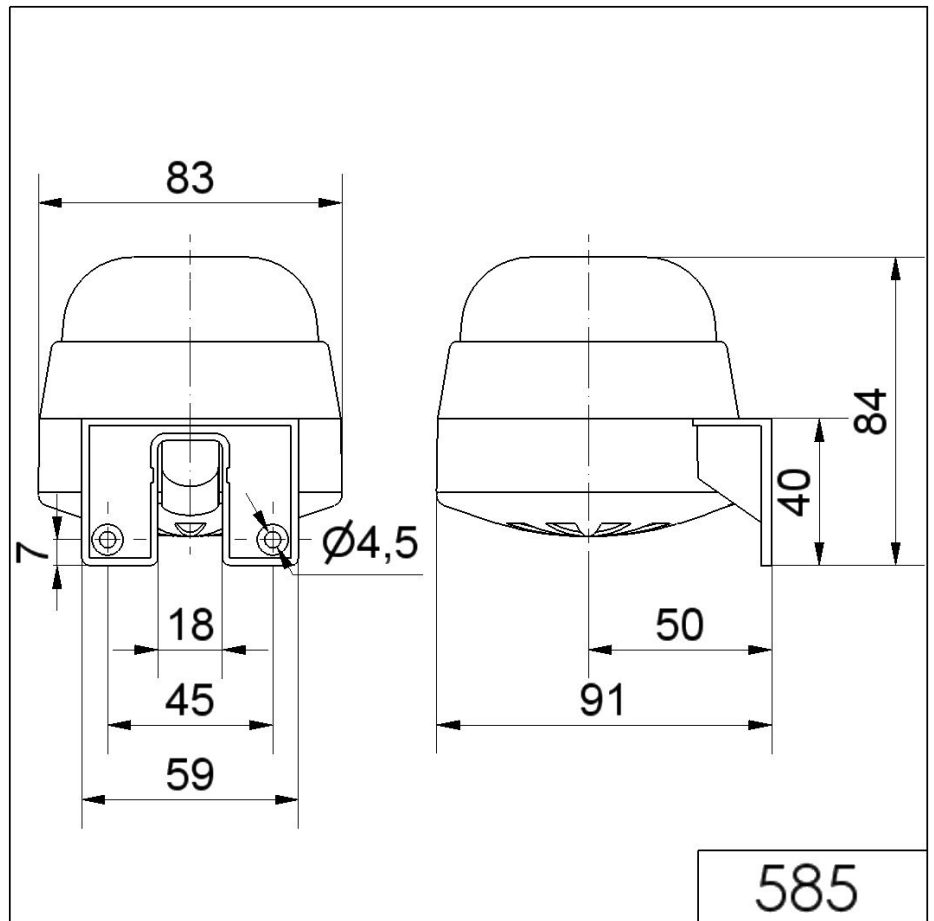

For additional installation and mounting information, refer to the appropriate user guide at www.werma.com. This printed copy is for information only and is subject to alteration.