



Sample image





## Datasheet

**Article number:** 70022632

**Designation:** KG20.T103/NL-EXBC.\*KNBOX

**Description:** Switch

IEC 60947-3 EN 60947-3, VDE 0660 Teil 107						
<b>Rated insulation voltage Ui</b>						
		Voltage (V) AC / DC				
		690 AC				
<b>Rated uninterrupted current Iu/Ith</b>						
Current (A)	Ambient temperature (°C)	Peak temperature (°C)		additional requirements		
25	50	55		Ambient temperature +50°C during 24 hours with peaks up to +55°C		
<b>Rated operational current Ie</b>						
Utilization category		Voltage (V)			Current (A)	
AC-32A		20 - 400			20	
<b>Rated operational power</b>						
Utilization category	Voltage (V)	No. of phases	No. of poles	Power (kW)		
AC-3	220 - 240	3	3	4		
AC-3	380 - 440	3	3	5,50		
AC-3	660 - 690	3	3	5,50		
AC-23A	220 - 240	3	3	5,50		
AC-23A	380 - 440	3	3	7,50		
AC-23A	660 - 690	3	3	7,50		
<b>Max Fuse Rating IEC</b>						
Fuse characteristic		No. of Fuses			Current (A)	
gG		1			35	
<b>UL60947-4-1 , UL508</b>						
<b>Nominal Voltage</b>						
		Voltage (V) AC / DC				
		600 AC				
<b>Rated insulation voltage Ui</b>						
		Voltage (V) AC / DC				
		600 AC				
<b>Rated thermal current</b>						
		Current (A)	Ambient temperature (°C)		Additional Text	
		25	0 - 40		-	
<b>Horsepower rating</b>						
Across-the-Line Motor Starting		Voltage (V)	No. of phases	No. of poles	Power (HP)	Ambient temperature [°C]
DOL		110 - 120	1	2	1	40
DOL		220 - 240	1	2	3	40
DOL		277 - 277	1	2	3	40
DOL		415 - 415	1	2	5	40
DOL		440 - 480	1	2	5	40
DOL		550 - 600	1	2	5	40
DOL		110 - 120	3	3	2	40
DOL		200 - 240	3	3	7,50	40
DOL		415 - 415	3	3	10	40
DOL		440 - 480	3	3	15	40
DOL		550 - 600	3	3	20	40
<b>Pilot duty rating code</b>						
Duty Code						
A600						
<b>SCCR / Max. fuse rating</b>						
Conditions of acceptability						
This device is suitable for use on circuits capable of delivering not more than 10kA rms symmetrical amperes, 600V ac max. when protected by Type RK1 fuses.						
Suitable for use on a circuit capable of delivering not more than 65000 rms symmetrical amperes at 600V max., when protected by 40A Class J fuses.						
<b>Temp. rating of wire</b>						
		Temperature rating (°C)	Current (A) Text			
		60 - 75	-- --			
<b>General Use</b>						
AC / DC	Voltage (V)	Current (A)	No. of phases	No. of poles	No. of contacts in series	
AC	277	25	1	1	1	
AC	600	25	1	2	1	

General Use						
AC / DC	Voltage (V)	Current (A)	No. of phases	No. of poles	No. of contacts in series	
AC	600	25	3	3	1	
General Information						
Text						
- The operating handle and position indicating means to be used with these manual motor controllers should be provided from the manufacturer, or the operating handle and position indicating means to be used should have been previously evaluated in combination with the manual motor controllers.						
- When intended for use as a motor disconnecter the device shall be provided with a method of being locked in the OFF-position.						
CSA						
Nominal Voltage						
Voltage (V) AC / DC						
600 AC						
Rated insulation voltage Ui						
Voltage (V) AC / DC						
600 AC						
Rated thermal current						
Current (A)		Ambient temperature (°C)		Additional Text		
25		0 - 40		-		
Horsepower rating						
Across-the-Line Motor Starting	Voltage (V)	No. of phases	No. of poles	Power (HP)	Ambient temperature [°C]	
DOL	110 - 120	1	2	1	40	
DOL	220 - 240	1	2	3	40	
DOL	277 - 277	1	2	3	40	
DOL	415 - 415	1	2	5	40	
DOL	440 - 480	1	2	5	40	
DOL	550 - 600	1	2	5	40	
DOL	110 - 120	3	3	2	40	
DOL	220 - 240	3	3	7,50	40	
DOL	415 - 415	3	3	10	40	
DOL	440 - 480	3	3	15	40	
DOL	550 - 600	3	3	20	40	
Pilot duty rating code						
Duty Code						
A600						
Temp. rating of wire						
Temperature rating (°C)			Current (A) Text			
75			-- --			
General Use						
AC / DC	Voltage (V)	Current (A)	No. of phases	No. of poles	No. of contacts in series	
AC	277	25	1	1	1	
AC	600	25	1	2	1	
AC	600	25	3	3	1	
GENERAL TECHNICAL INFORMATION						
Tightening torque of screws						
tightening torque (Nm)			tightening torque (lb-in)			
1,25			11			
Stripping length						
Length (mm) -						
9 STRIPPINGLENGTH						
Size of conductor						
composition of conductor	Min. / Max. value	No. of conductor per terminal		Cross section (mm <sup>2</sup> ) or (AWG/kcmil)	Material of the wire	
flexible wire	Max.	1		AWG 10	Copper	
flexible wire	Max.	1		4mm <sup>2</sup>	Copper	
Single-core or stranded wire	Max.	1		6mm <sup>2</sup>	Copper	
Single-core or stranded wire	Max.	1		AWG 10	Copper	
flexible wire with sleeve	Max.	1		4mm <sup>2</sup>	Copper	
Approbations						
Specification						Marking
EAC						
CE marking						
UK Directives						
CSA C.22.2 No.14						
GB/T14048.3						
Recommended screw driver						
Type of screw driver		Value				
Cross Screwdriver		PH2				
Slot screwdriver according to DIN 5264		0,8x4				
General Information						
Text						
- EMC Note: This device is suitable for use in environment A and B.						

### General Information

#### Text

- Do not lubricate or treat contacts.
- Switches may only be mounted, connected and set into operation by qualified persons according to the accepted rules of technology.
- Use copper wire only. Do not coat the wire end with tin.
- Terminals with factory fitted jumper links are tightened during production. Take care during installation to ensure factory fitted links are not lost by undoing both sides of linked terminals. After wiring, all terminal screws must be tightened to recommended torque specifications.

### Waste Electrical & Electronic Equipment (WEEE)

#### Picture name

#### Description



Do not throw in the trash as care must be taken to ensure environmentally sound disposal and recycling. Please either use an environmentally friendly waste disposal company; return to the supplier for disposal, or return direct to the manufacturer, Kraus & Naimer. You can find local Kraus & Naimer offices at [www.krausnaimer.com](http://www.krausnaimer.com)

### Proposition 65

#### Picture name

#### Description



WARNING: This product can expose you to chemicals including nickel and lead, which is known to the State of California to cause cancer. For more information go to [www.P65Warnings.ca.gov](http://www.P65Warnings.ca.gov).

Classification Contact: Rigid contact bridge

Classification Contact Mat: Silver

Classification Terminal: Screw terminal

### Mounting-VE

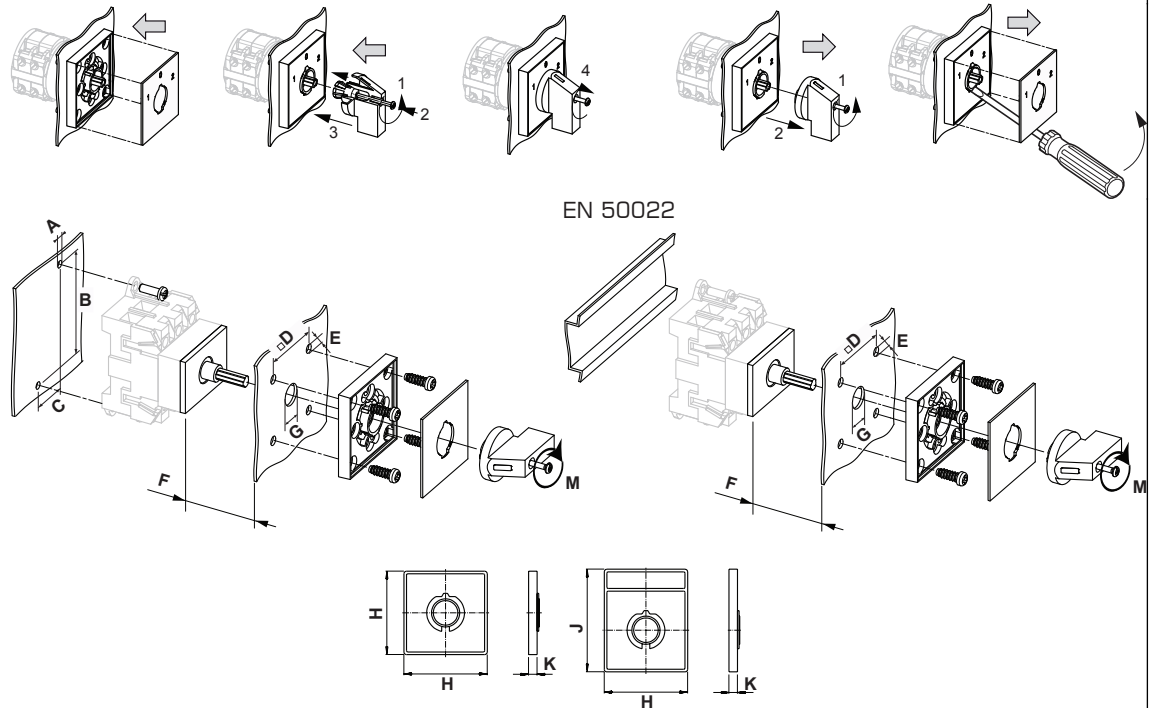

IP - Code front side		IP40
Stages		1,00 - 5,00
A	∅	4,10 mm
B	H	60,00 mm
B_tol.	H	± 0,50 mm
C	H	22,00 mm
C_tol.	H	± 0,50 mm
D	□	36,00 mm
E	∅	5,00 mm
F	H	<= 12,00 mm
G	∅	10,00 - 15,00 mm
H	H	48,00 mm
J	H	59,00 mm
K	H	6,70 mm
M	⌘	0,50 Nm

## Wiring diagram

KG20A.T303.VE

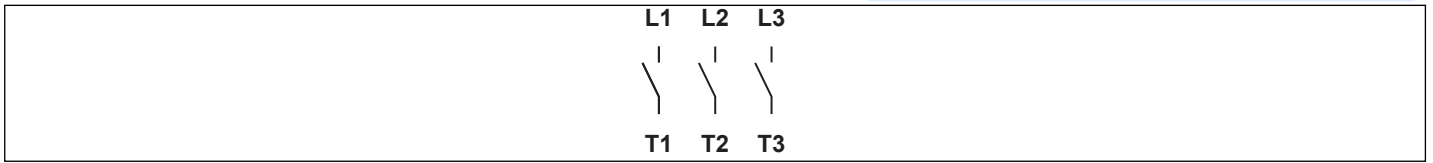



**Face plate**

S1.F991/A00.P2B

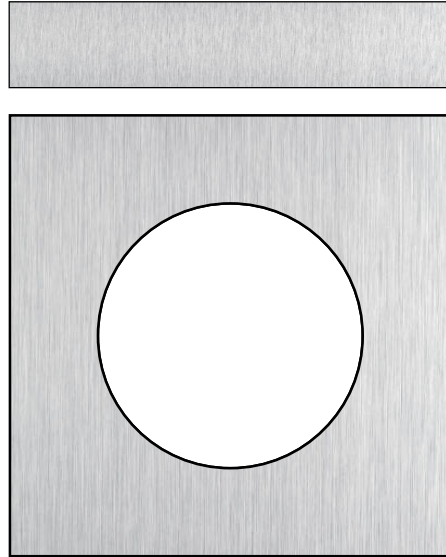

## AUXILIARY CONTACTS (cam operated) for switch type KG20 - KG100C and KH(R)16 - KH(R)25B

**Designation:** K0.M510A/2CA-B

**Number of contacts:** "2" 2 auxiliary contacts

**Operation of contacts:** "C" 1 auxiliary contact closed in pos. 1 and 1 auxiliary contact closed in pos. 0 (NO/NC)

**Type of version:** "A" 1. auxiliary contact module

**Type of mounting:** "-B" for type of mounting VE, VE2, silver contacts

IEC 60947-3 EN 60947-3, VDE 0660 Teil 107						
<b>Nominal Voltage</b>						
			Voltage (V) AC / DC			
			500 AC			
			690 AC			
<b>Rated uninterrupted current Iu/Ith</b>						
Current (A)	Ambient temperature (°C)		Peak temperature (°C)	additional requirements		
10	55		60	Ambient temperature +55°C during 24 hours with peaks up to +60°C		
16	55		60	Ambient temperature +55°C during 24 hours with peaks up to +60°C		
<b>Rated operational current Ie</b>						
Utilization category			Voltage (V)		Current (A)	
AC-15			110 - 240		2,50	
AC-15			380 - 440		1,50	
AC-15			500		1	
AC-21A			500		10	
UL60947-4-1 , UL508						
<b>Nominal Voltage</b>						
			Voltage (V) AC / DC			
			600 AC			
<b>Rated insulation voltage Ui</b>						
			Voltage (V) AC / DC			
			600 AC			
<b>Rated thermal current</b>						
		Current (A)	Ambient temperature (°C)		Additional Text	
		10	0 - 40		-	
<b>Pilot duty rating code</b>						
Duty Code						
A600						
<b>General Use</b>						
AC / DC	Voltage (V)	Current (A)	No. of phases	No. of poles	No. of contacts in series	
AC	600	10	1	1	1	
GENERAL TECHNICAL INFORMATION						
<b>Tightening torque of screws</b>						
			tightening torque (Nm)		tightening torque (lb-in)	
			0,60		5	
<b>Stripping length</b>						
			Length (mm) -			
			6 STRIPPINGLENGTH			
<b>Size of conductor</b>						
composition of conductor	Min. / Max. value		No. of conductor per terminal	Cross section (mm <sup>2</sup> ) or (AWG/kcmil)		Material of the wire
solid wire	Min.		1	0.5mm <sup>2</sup>		Copper
solid wire	Min.		2	0.5mm <sup>2</sup>		Copper
flexible wire	Min.		1	0.75mm <sup>2</sup>		Copper
flexible wire	Min.		2	0.75mm <sup>2</sup>		Copper
flexible wire	Max.		2	AWG 16		Copper
flexible wire	Max.		2	1.5mm <sup>2</sup>		Copper
Single-core or stranded wire	Max.		2	AWG 14		Copper

<b>Size of conductor</b>				
<i>composition of conductor</i>	<i>Min. / Max. value</i>	<i>No. of conductor per terminal</i>	<i>Cross section (mm<sup>2</sup>) or (AWG/kcmil)</i>	<i>Material of the wire</i>
Single-core or stranded wire	Max.	2	1.5mm <sup>2</sup>	Copper
flexible wire with ferrule according to DIN 46228	Max.	2	1mm <sup>2</sup>	Copper
flexible wire with ferrule according to DIN 46228	Min.	1	0.5mm <sup>2</sup>	Copper
flexible wire with ferrule according to DIN 46228	Min.	2	0.5mm <sup>2</sup>	Copper
<b>Recommended screw driver</b>				
<i>Type of screw driver</i>	<i>Value</i>			
Cross Screwdriver	PH1			
Slot screwdriver according to DIN 5264	0,6x3,5			
<b>General Information</b>				
<i>Text</i>				
<ul style="list-style-type: none"> <li>- Do not lubricate or treat contacts.</li> <li>- Switches may only be mounted, connected and set into operation by qualified persons according to the accepted rules of technology.</li> <li>- Use copper wire only. Do not coat the wire end with tin.</li> </ul>				

