



Sample image





Datasheet

Article number: 70022632

Designation: KG20.T103/NL-EXBC.*KNBOX

Description: Switch

IEC 60947-3 EN 60947-3, VDE 0660 Teil 107						
Tension assignée d'isolement Ui						
			<i>Tension (V) AC / DC</i>			
			690 AC			
Courant ininterrompu et thermique conventionnel Iu/Ith						
<i>Intensité (A)</i>	<i>Température Ambiante (°)</i>	<i>Température Maxi (°)</i>	<i>Spécification complémentaire</i>			
25	50	55	Température ambiante +50°C durant 24 heures avec point à +55°C			
Courant assigné d'emploi Ie						
<i>Catégorie d'emploi</i>			<i>Tension (V)</i>		<i>Intensité (A)</i>	
AC-32A			20 - 400		20	
Puissance assignée d'emploi						
<i>Catégorie d'emploi</i>	<i>Tension (V)</i>	<i>Nb de phases</i>	<i>Nb de pôles</i>	<i>Puissance (kW)</i>		
AC-3	220 - 240	3	3	4		
AC-3	380 - 440	3	3	5,50		
AC-3	660 - 690	3	3	5,50		
AC-23A	220 - 240	3	3	5,50		
AC-23A	380 - 440	3	3	7,50		
AC-23A	660 - 690	3	3	7,50		
Protection par fusible (IEC)						
<i>Caractéristique</i>			<i>Nombre de fusible</i>		<i>Intensité (A)</i>	
gG			1		35	
UL60947-4-1 , UL508						
Nominal Voltage						
			<i>Tension (V) AC / DC</i>			
			600 AC			
Tension assignée d'isolement Ui						
			<i>Tension (V) AC / DC</i>			
			600 AC			
Rated thermal current						
		<i>Intensité (A)</i>	<i>Température Ambiante (°)</i>	<i>Additional Text</i>		
		25	0 - 40	-		
Horsepower rating						
<i>Across-the-Line Motor Starting</i>	<i>Tension (V)</i>	<i>Nb de phases</i>	<i>Nb de pôles</i>	<i>Power (HP)</i>	<i>Ambient temperature [°C]</i>	
DOL	110 - 120	1	2	1	40	
DOL	220 - 240	1	2	3	40	
DOL	277 - 277	1	2	3	40	
DOL	415 - 415	1	2	5	40	
DOL	440 - 480	1	2	5	40	
DOL	550 - 600	1	2	5	40	
DOL	110 - 120	3	3	2	40	
DOL	200 - 240	3	3	7,50	40	
DOL	415 - 415	3	3	10	40	
DOL	440 - 480	3	3	15	40	
DOL	550 - 600	3	3	20	40	
Pilot duty rating code						
<i>Duty Code</i>						
A600						
SCCR / Max. fuse rating						
<i>Conditions of acceptability</i>						
This device is suitable for use on circuits capable of delivering not more than 10kA rms symmetrical amperes, 600V ac max. when protected by Type RK1 fuses.						
Suitable for use on a circuit capable of delivering not more than 65000 rms symmetrical amperes at 600V max., when protected by 40A Class J fuses.						
Temp. rating of wire						
			<i>Temperature rating (°C)</i>	<i>Intensité (A) Text</i>		
			60 - 75	-- --		
General Use						
<i>AC / DC</i>	<i>Tension (V)</i>	<i>Intensité (A)</i>	<i>Nb de phases</i>	<i>Nb de pôles</i>	<i>No. of contacts in series</i>	
AC	277	25	1	1	1	
AC	600	25	1	2	1	

General Use					
AC / DC	Tension (V)	Intensité (A)	Nb de phases	Nb de pôles	No. of contacts in series
AC	600	25	3	3	1
General Information					
Text					
- The operating handle and position indicating means to be used with these manual motor controllers should be provided from the manufacturer, or the operating handle and position indicating means to be used should have been previously evaluated in combination with the manual motor controllers.					
- When intended for use as a motor disconnecter the device shall be provided with a method of being locked in the OFF-position.					
CSA					
Nominal Voltage					
			Tension (V) AC / DC		
			600 AC		
Tension assignée d'isolement Ui					
			Tension (V) AC / DC		
			600 AC		
Rated thermal current					
		Intensité (A)	Température Ambiante (°)		Additional Text
		25	0 - 40		-
Horsepower rating					
Across-the-Line Motor Starting					
	Tension (V)	Nb de phases	Nb de pôles	Power (HP)	Ambient temperature [°C]
DOL	110 - 120	1	2	1	40
DOL	220 - 240	1	2	3	40
DOL	277 - 277	1	2	3	40
DOL	415 - 415	1	2	5	40
DOL	440 - 480	1	2	5	40
DOL	550 - 600	1	2	5	40
DOL	110 - 120	3	3	2	40
DOL	220 - 240	3	3	7,50	40
DOL	415 - 415	3	3	10	40
DOL	440 - 480	3	3	15	40
DOL	550 - 600	3	3	20	40
Pilot duty rating code					
Duty Code					
A600					
Temp. rating of wire					
			Temperature rating (°C)	Intensité (A)	Text
			75	--	--
General Use					
AC / DC	Tension (V)	Intensité (A)	Nb de phases	Nb de pôles	No. of contacts in series
AC	277	25	1	1	1
AC	600	25	1	2	1
AC	600	25	3	3	1
GENERAL TECHNICAL INFORMATION					
Tightening torque of screws					
			tightening torque (Nm)	tightening torque (lb-in)	
			1,25	11	
Stripping length					
			Length (mm)	-	
			9	STRIPPINGLENGTH	
Size of conductor					
composition of conductor	Min. / Max. value	No. of conductor per terminal		Cross section (mm ²) or (AWG/kcmil)	Material of the wire
flexible wire	Max.	1		AWG 10	Copper
flexible wire	Max.	1		4mm ²	Copper
Single-core or stranded wire	Max.	1		6mm ²	Copper
Single-core or stranded wire	Max.	1		AWG 10	Copper
flexible wire with sleeve	Max.	1		4mm ²	Copper
Approbations					
Specification					Marking
EAC					
CE marking					
UK Directives					
CSA C.22.2 No.14					
GB/T14048.3					
Recommandations concernant le tournevis					
Type	Value				
Tournevis cruciforme	PH2				
Slot screwdriver according to DIN 5264	0,8x4				
General Information					
Text					
- EMC Note: This device is suitable for use in environment A and B.					

General Information

Text

- Ne jamais lubrifier ou traiter les contacts.
- Les commutateurs ne peuvent être montés, branchés et mis en service que par une personne qualifiée selon les règles techniques en vigueur.
- Use copper wire only. Do not coat the wire end with tin.
- Les bornes qui ne sont pas supposées être utilisées pour le raccordement de l'appareil sont livrées serrées et ne doivent pas être desserrées. Si toutefois ces bornes sont malgré tout ouvertes accidentellement, vérifier qu'aucun shunt n'est manquant. Le câblage terminé, s'assurer que toutes les bornes sont serrées.

Waste Electrical & Electronic Equipment (WEEE)

Picture name

Description



Do not throw in the trash as care must be taken to ensure environmentally sound disposal and recycling. Please either use an environmentally friendly waste disposal company, return to the supplier for disposal, or return direct to the manufacturer, Kraus & Naimer. You can find local Kraus & Naimer offices at www.krausnaimer.com

Proposition 65

Picture name

Description



WARNING: This product can expose you to chemicals including nickel and lead, which is known to the State of California to cause cancer. For more information go to www.P65Warnings.ca.gov.

Type de contacts: Rigid contact bridge

Revêtement des Contacts: Silver

Types de raccordement: Screw terminal

Fixation-VE

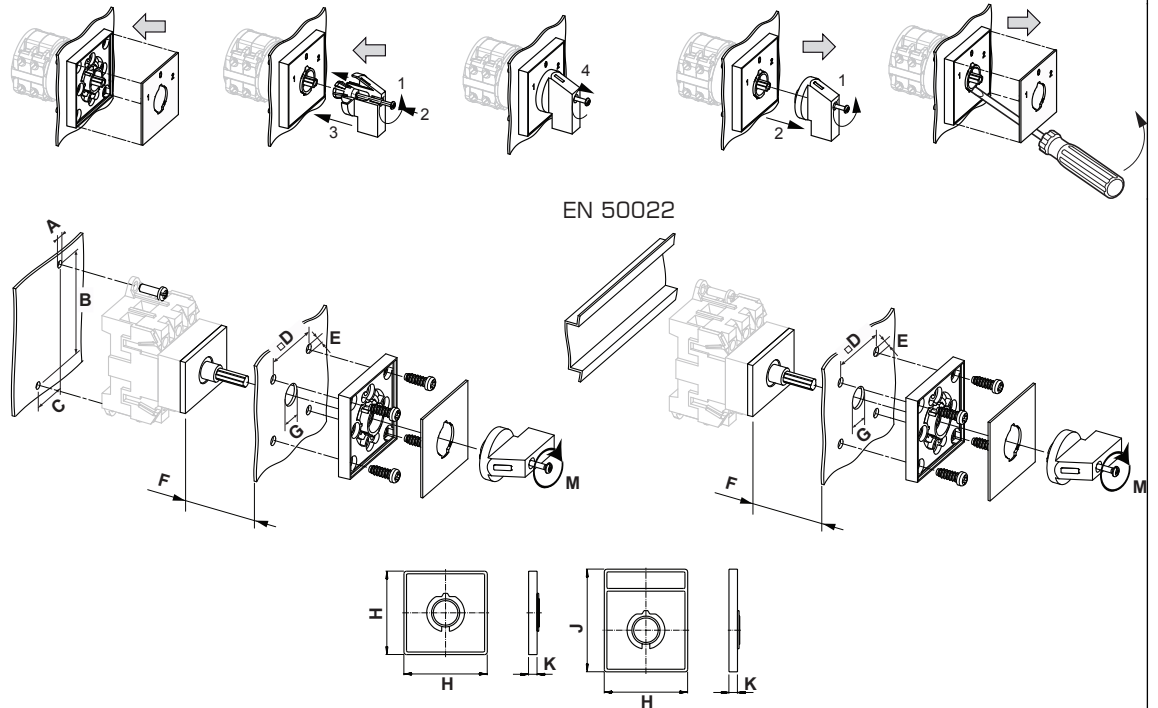

IP - Code front side		IP40
Stages		1,00 - 5,00
A	∅	4,10 mm
B	H	60,00 mm
B_tol.	H	± 0,50 mm
C	H	22,00 mm
C_tol.	H	± 0,50 mm
D	□	36,00 mm
E	∅	5,00 mm
F	H	<= 12,00 mm
G	∅	10,00 - 15,00 mm
H	H	48,00 mm
J	H	59,00 mm
K	H	6,70 mm
M	⌘	0,50 Nm

Wiring diagram

KG20A.T303.VE

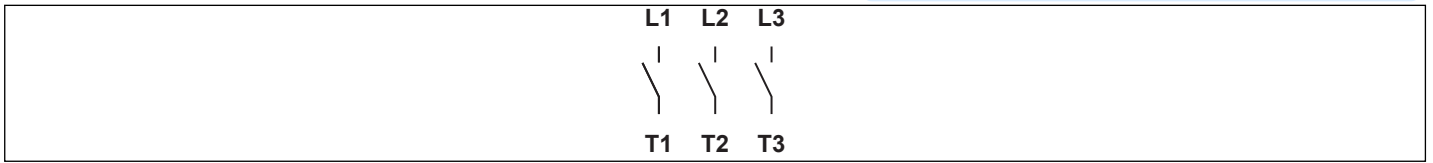

Face plate

S1.F991/A00.P2B

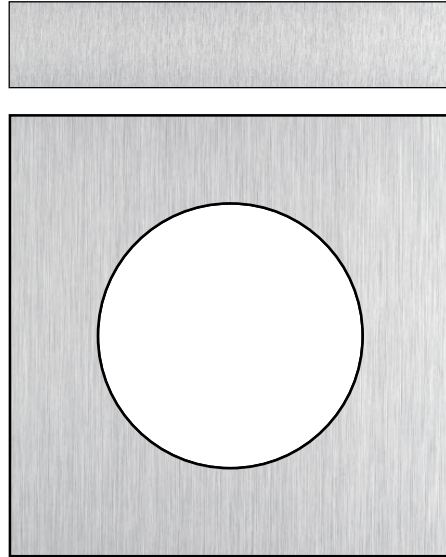

AUXILIARY CONTACTS (cam operated) for switch type KG20 - KG100C and KH(R)16 - KH(R)25B

Designation: K0.M510A/2CA-B

Number of contacts: "2" 2 auxiliary contacts

Operation of contacts: "C" 1 auxiliary contact closed in pos. 1 and 1 auxiliary contact closed in pos. 0 (NO/NC)

Type of version: "A" 1. auxiliary contact module

Type of mounting: "-B" for type of mounting VE, VE2, silver contacts

IEC 60947-3 EN 60947-3, VDE 0660 Teil 107					
Nominal Voltage					
		<i>Tension (V) AC / DC</i>			
		500 AC			
		690 AC			
Courant ininterrompu et thermique conventionnel lu/lth					
<i>Intensité (A)</i>	<i>Température Ambiante (°)</i>	<i>Température Maxi (°)</i>	<i>Spécification complémentaire</i>		
10	55	60	Température ambiante +55°C durant 24 heures avec point à +60°C		
16	55	60	Température ambiante +55°C durant 24 heures avec point à +60°C		
Courant assigné d'emploi le					
<i>Catégorie d'emploi</i>		<i>Tension (V)</i>		<i>Intensité (A)</i>	
AC-15		110 - 240		2,50	
AC-15		380 - 440		1,50	
AC-15		500		1	
AC-21A		500		10	
UL60947-4-1 , UL508					
Nominal Voltage					
		<i>Tension (V) AC / DC</i>			
		600 AC			
Tension assignée d'isolement Ui					
		<i>Tension (V) AC / DC</i>			
		600 AC			
Rated thermal current					
		<i>Intensité (A)</i>	<i>Température Ambiante (°)</i>	<i>Additional Text</i>	
		10	0 - 40	-	
Pilot duty rating code					
<i>Duty Code</i>					
A600					
General Use					
<i>AC / DC</i>	<i>Tension (V)</i>	<i>Intensité (A)</i>	<i>Nb de phases</i>	<i>Nb de pôles</i>	<i>No. of contacts in series</i>
AC	600	10	1	1	1
GENERAL TECHNICAL INFORMATION					
Tightening torque of screws					
		<i>tightening torque (Nm)</i>		<i>tightening torque (lb-in)</i>	
		0,60		5	
Stripping length					
		<i>Length (mm) -</i>			
		6 STRIPPINGLENGTH			
Size of conductor					
<i>composition of conductor</i>	<i>Min. / Max. value</i>	<i>No. of conductor per terminal</i>	<i>Cross section (mm²) or (AWG/kcmil)</i>		<i>Material of the wire</i>
solid wire	Min.	1	0,5mm²		Copper
solid wire	Min.	2	0,5mm²		Copper
flexible wire	Min.	1	0,75mm²		Copper
flexible wire	Min.	2	0,75mm²		Copper
flexible wire	Max.	2	AWG 16		Copper
flexible wire	Max.	2	1,5mm²		Copper
Single-core or stranded wire	Max.	2	AWG 14		Copper

Size of conductor				
<i>composition of conductor</i>	<i>Min. / Max. value</i>	<i>No. of conductor per terminal</i>	<i>Cross section (mm²) or (AWG/kcmil)</i>	<i>Material of the wire</i>
Single-core or stranded wire	Max.	2	1,5mm ²	Copper
flexible wire with ferrule according to DIN 46228	Max.	2	1mm ²	Copper
flexible wire with ferrule according to DIN 46228	Min.	1	0,5mm ²	Copper
flexible wire with ferrule according to DIN 46228	Min.	2	0,5mm ²	Copper
Recommandations concernant le tournevis				
<i>Type</i>	<i>Value</i>			
Tournevis cruciforme	PH1			
Slot screwdriver according to DIN 5264	0,6x3,5			
General Information				
<i>Text</i>				
- Ne jamais lubrifier ou traiter les contacts. - Les commutateurs ne peuvent être montés, branchés et mis en service que par une personne qualifiée selon les règles techniques en vigueur. - Use copper wire only. Do not coat the wire end with tin.				

