

Reliable detection of difficult workpieces helps reduce equipment design and commissioning time



E3AS Series changes the “way of using” reflective photoelectric sensors

In order to satisfy various consumers' needs, products have become more diversified, and got shorter life cycles. As a result of advanced equipment and shortage of skilled workers, quick equipment design and stable operation are critical issues at manufacturing sites. OMRON's E3AS Series offers new ways of using reflective photoelectric sensors to reduce equipment commissioning time.



TOF Laser Sensor
E3AS-F

CMOS Laser Sensor
E3AS-HL

Distance-settable
Photoelectric Sensor
E3AS-L

Complex-shaped, colored, patterned, or glossy surfaces can be detected

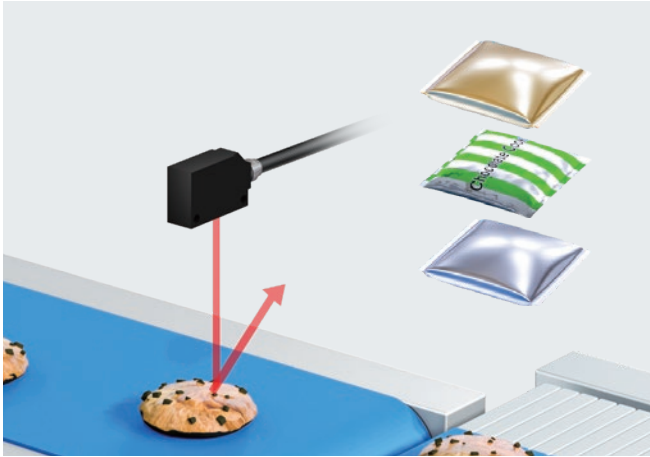

Design

Stable detection for variable workpiece eliminates the need for redesign

P.4

Flexible to design with no need for reflectors

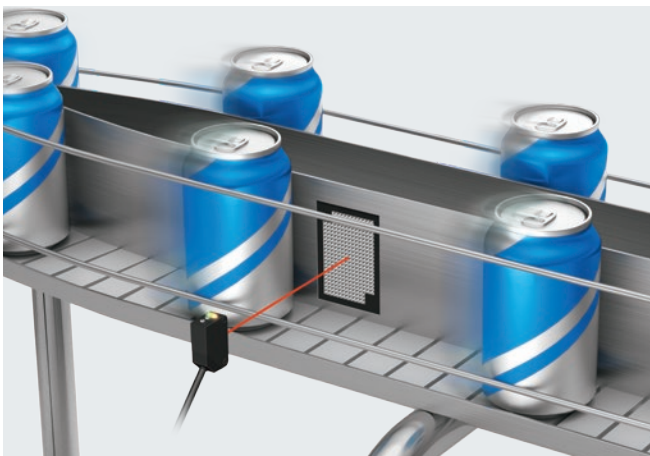

Design

Compact body overcomes space limitations, increasing design flexibility

P.6

Easy to commission and maintain with no reliance on people's skills



Commissioning

Teaching enables easy, quick, and optimal setting

P.8

Maintenance

Enhanced environmental resistance reduces line downtime and maintenance frequency

P.10

Stable detection for variable workpieces eliminates the need for redesign

Conventional sensors have to be selected each time the shape, color, pattern, or reflectivity of the workpiece changes, so the equipment sometimes need to be redesigned. The E3AS Series can detect workpieces without being significantly affected by variable shapes, colors, and materials, saving redesign time.

E3AS-HL for complex-shaped, colored, patterned, or glossy workpieces

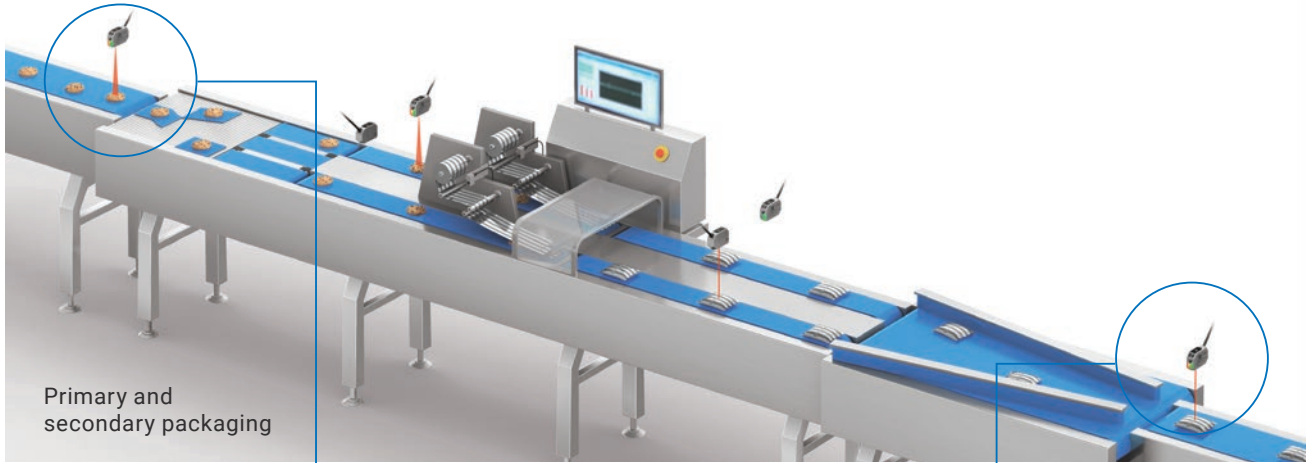

Stable detection for uneven surfaces

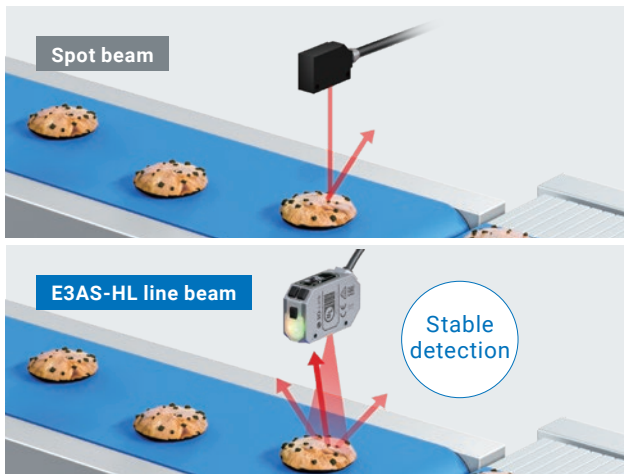

With spot beam, detection is unstable since the reflected light does not reach the sensor depending on the profile of the workpiece surface. With the line beam of the E3AS-HL Sensor, detection is less affected by the profile of the surface since the reflected light reaches the sensor from any part of the surface.

Stable detection for various colored, patterned, or glossy workpieces

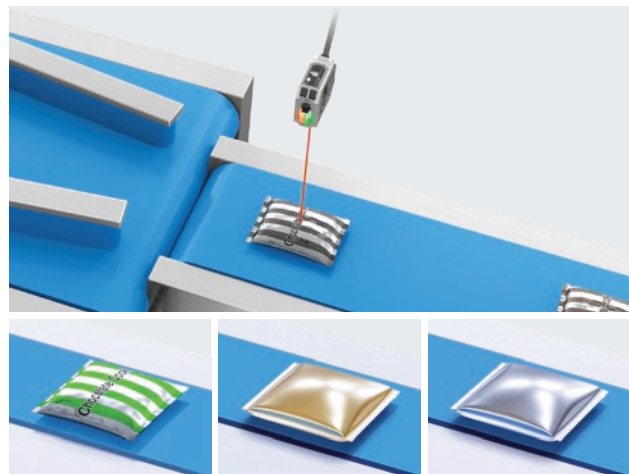

Detection is prone to be unstable because color, pattern, or reflectivity affects the sensing distance. The E3AS-HL Sensor is less likely to be affected by them, providing stable detection even when packaging materials change.

CMOS sensing with built-in lens alignment technology minimizes the influence of material properties PATENT PENDING *1

From Material properties greatly affect the detection due to blurred received light spot on CMOS as a result of low position adjustment accuracy of the receiver lens.

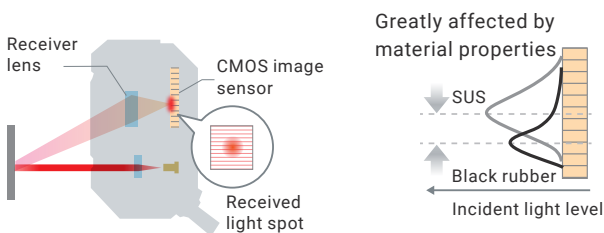

To Material properties hardly affect the detection since the receiver lens position is automatically adjusted to the micrometer level to minimize the received light spot.

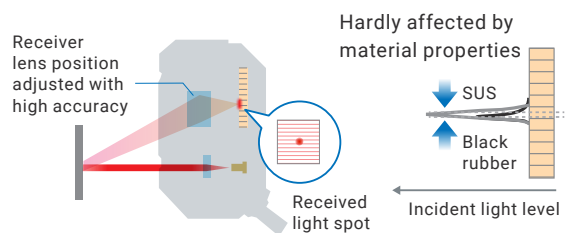

E3AS-L for simple-shaped, low-reflective workpieces

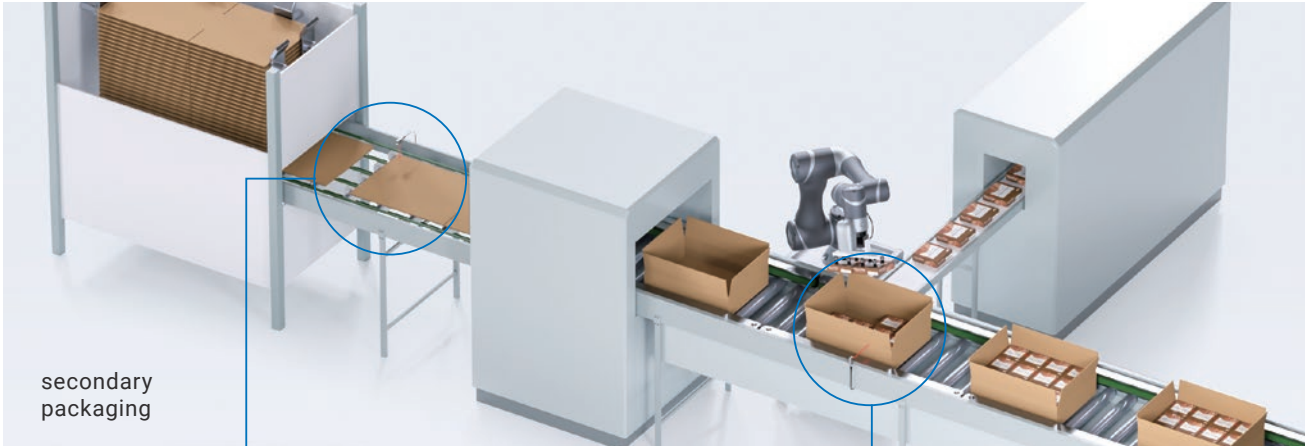

Stable level difference detection for various colored workpieces

Stable detection for various colored boxes

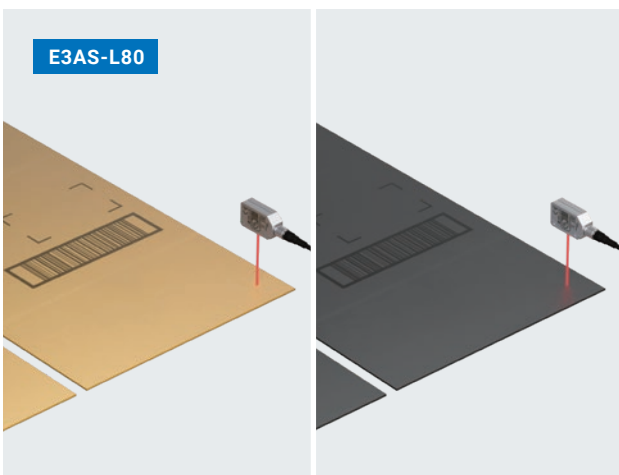

Detection may become unstable as differential travel varies depending on the workpiece color. The E3AS-L80 Sensor can reliably detect level difference regardless of color since its differential travel for black paper is 5%.

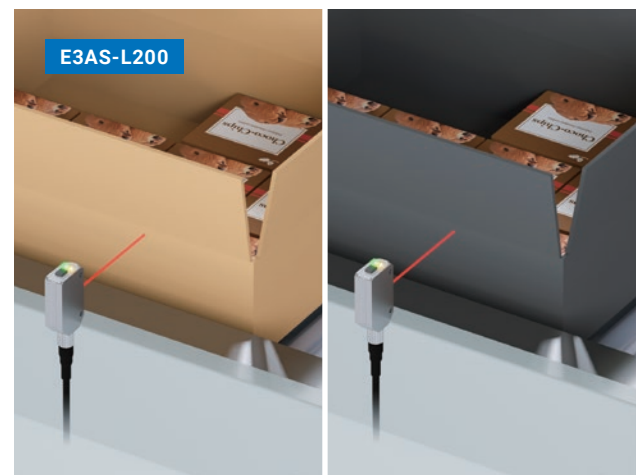

When the workpiece is low-reflective black paper, detection may become unstable due to insufficient sensing distance. The E3AS-L200 Sensor can stably detect at the same distance regardless of color since its sensing distance for both white paper and black paper is 200 mm.

OMRON's unique LED package stably detects low-reflective workpieces

The E3AS-L Sensor is equipped with an emitter 6 times more powerful than those of conventional models^{*2}, and delivers stable detection due to its ability of receiving light reflected by low-reflective workpieces.

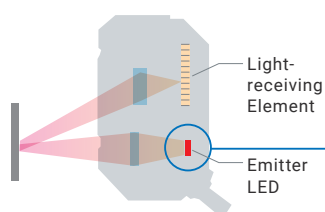

E3AS-L80

High-efficiency custom point light source LED with improved light extraction efficiency



LED light emitter

E3AS-L200

High-efficiency combined LED package with microlens that increases light density



Microlens
LED
Cross section

*1. "Patent pending" means that we applied for a patent in Japan. (As of December 2021) *2. Comparison with E3Z-LS products.

Overcomes space limitations, increasing design flexibility

Retro-reflective sensors are used to detect difficult workpieces or where long sensing distance is needed. Designing with retro-reflective sensors is time consuming due to installation space constraints as the equipment gets sophisticated and complex. On the other hand, the E3AS Series allows for designing without reflectors.

E3AS-HL for multi-lane conveyor lines of workpieces with curved surface

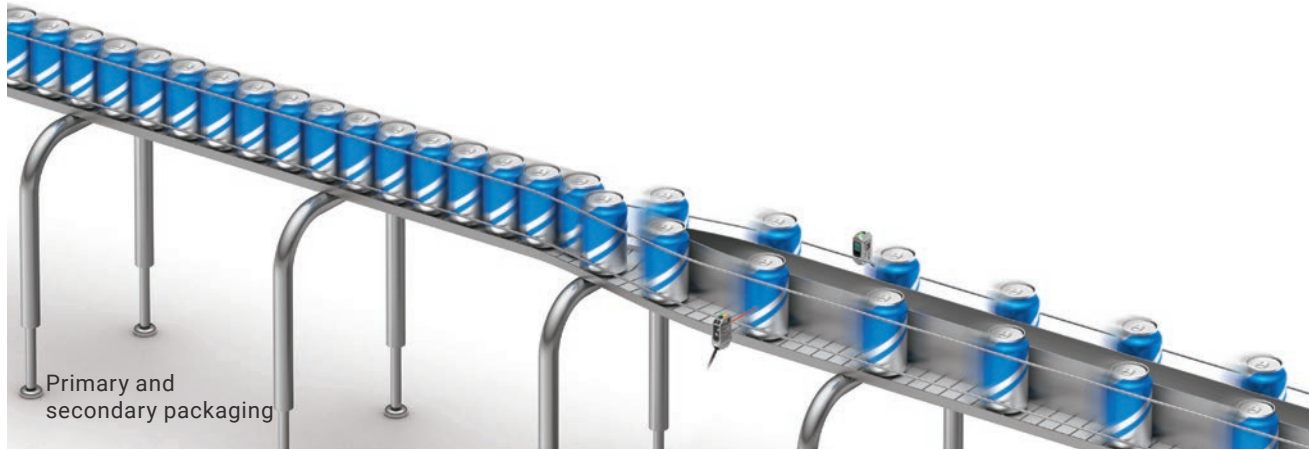

Stably detects cans and plastic bottles without reflectors

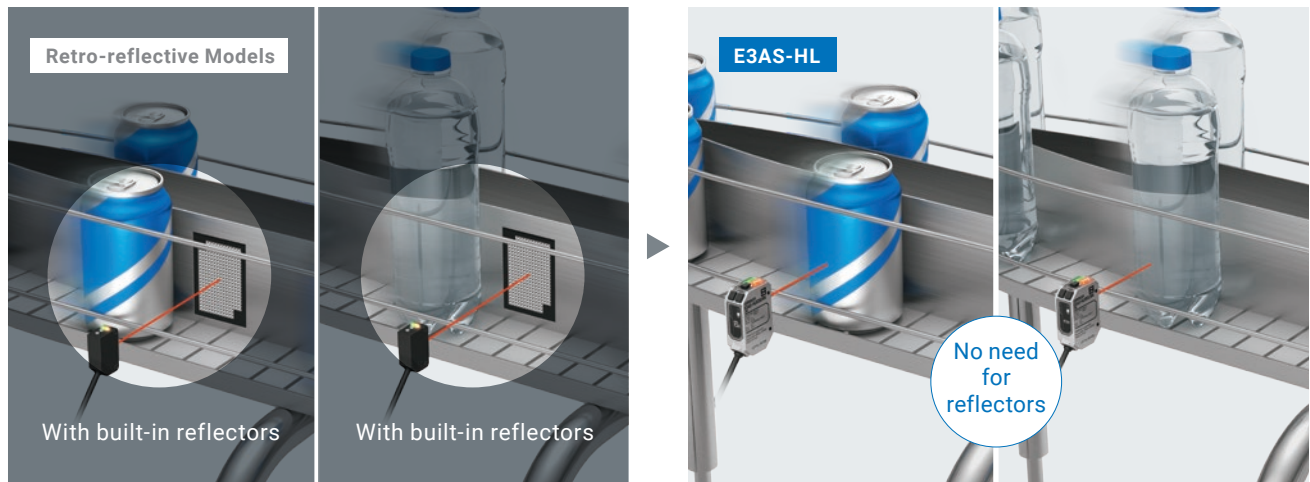

Retro-reflective sensors are used to detect poorly reflective curved surfaces of cans and transparent plastic bottles, but securing installation space for reflectors on multi-lane conveyor lines is difficult.

The E3AS-HL Sensor, a reflective model capable of detecting the slightest change in the incident light level or distance, can stably detect cans and plastic bottles without reflectors.

Sensing algorithm detects minimal reflected light from curved surface

Industry First *1 **PATENTED** *2

E3AS-HL Sensors equipped with FPGA use the industry-first sensing algorithm to perform high-speed sampling of received light waveforms at 10,000 times per second and OMRON's unique accumulation processing, significantly increasing its sensitivity. They amplify the slightest amount of light to stably detect workpieces with glossy or uneven surfaces, complex shaped workpieces, or other workpieces from which it is difficult to receive reflected light.

Note: Not applicable to transparent objects.

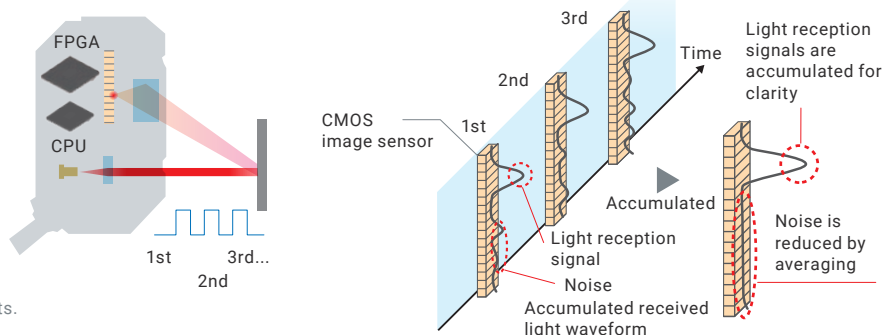

E3AS-F for long-distance sensing on converging and diverging lines



No reflector is required to design long-distance sensing unaffected by color or material of workpieces



Although retro-reflective sensors are used for long-distance sensing in converging and diverging lines, it is difficult to find installation space for reflectors.

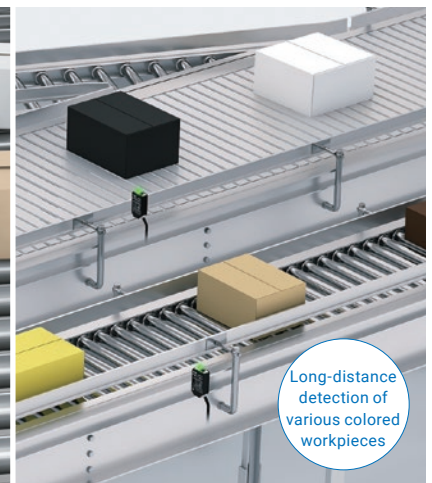

The E3AS-F Sensor, a reflective model with long sensing distance, does not require reflectors. Moreover, it is less likely to be affected by color even from long distances.

TOF detects varying workpieces and measures distance

In the TOF (Time of Flight) method, the distance is measured based on the elapsed time instead of the amount of incident light received. Measurements therefore are not affected by changes in the color or material of the workpiece. This means that low-reflective workpieces, such as black rubber, can be detected from longer distances.

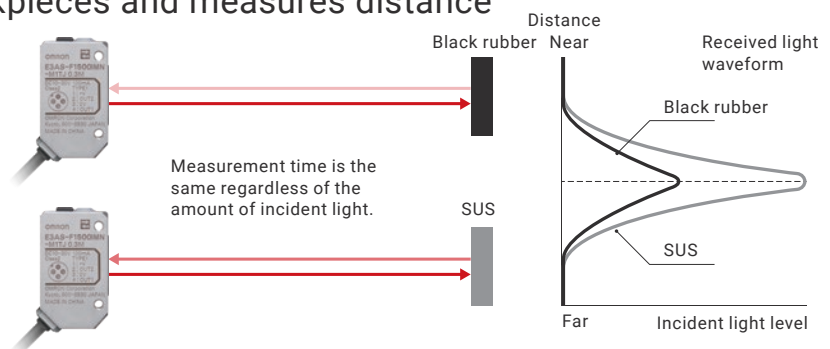

*1. Based on OMRON investigation in September 2019. *2. "PATENTED" means that we obtained a patent in Japan. (As of December 2021)

Teaching enables easy, quick, and optimal setting

E3AS Sensors allow virtually anyone to easily set optimal settings using the teaching method, eliminating rework due to problems during commissioning. Moreover, easy-to-standardize operability makes remote work instructions simple.

Single teach button prevents inconsistent settings

Easily and consistently set the optimal threshold level using the teach button



Background teaching

Set the threshold level at a point before the background (reference surface).



Two-point teaching

Set the threshold level at a value halfway between that when a workpiece is present and when one is not.

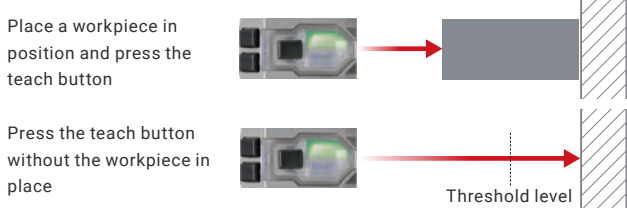

Key locking

The key locking function prevents malfunction after setting.

Fast and easy setup also when setting a large number of sensors

Sensitivity adjustment using the conventional adjuster method requires experience, finesse as well as time since the threshold level must be adjusted one unit at a time.

With the E3AS Series, just press the teach button to automatically set the threshold level, enabling fast and easy setting.

Adjuster method

The adjuster must be turned to the left and right with a screwdriver for each and every unit because sensitivity differs depending on the installation location.

60 s 60 s 60 s 60 s 60 s

$60\text{ s} \times 5\text{ units} = 300\text{ s in total}$

Teaching method (E3AS)

Setup can be completed by simply pressing the teach button on each sensor unit for 3 seconds.

3 s 3 s 3 s 3 s 3 s

Adjustment time reduced by 95%

$3\text{ s} \times 5\text{ units} = 15\text{ s in total}$

Background Reference Teaching (sensitive) for easy setup of transparent object detection PATENT PENDING ^{*1} CMOS E3AS-HL

Previously, the setup of sensors for transparent objects required the experience and finesse of skilled workers, but it can now be done with just the press of a button. The E3AS-HL Sensor detects presence of workpieces from the variation (correlation) of background distance information and incident light level information.

1. Correlation is 100% without a workpiece in place.



Without workpiece
(Correlation is 100%)

2. A transparent object (e.g., glass or plastic bottle) passing through is detected as the correlation with the background changes.



With workpiece
(Example: Correlation is 40%)



Easy-to-read, easy-to-understand OLED display CMOS E3AS-HL

Threshold level and detected value display on the same screen makes threshold level setting easy. Moreover, wide viewing angle and display inverting allow on-site workers to easily see the display.

Detected value and threshold level at a glance

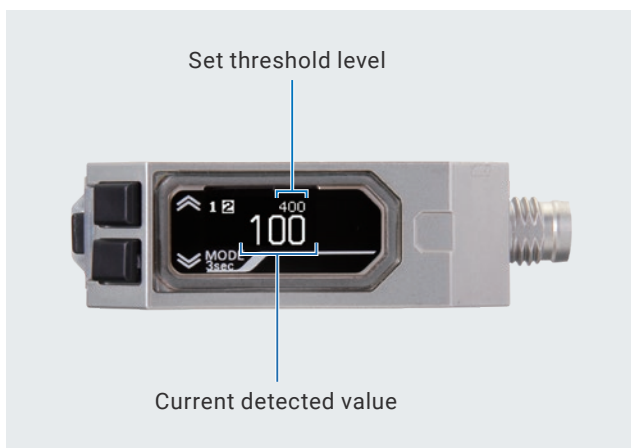

Detection display switching based on purpose

Bar display to grasp detection margin at a glance



ON/OFF display to easily check control output status



Easy-to-read setup menu display



Wide viewing angle allows reading from an angle



Invert display depending on sensor installation orientation

Inverting: Disabled



Inverting: Enabled



*1. "Patent pending" means that we applied for a patent in Japan. (As of December 2021)

Enhanced environmental resistance reduces line downtime and maintenance frequency

When a sensor malfunction due to the environment causes a line stoppage during mass production, it can take a long time to restart. With enhanced environmental resistance, the E3AS Series will be realized minimize line downtime and maximize uptime.

Antifouling coating on sensing surface reduces false detection and cleaning frequency Industry First *1 PATENT PENDING *2

A dirty sensing surface can cause false detection due to the principle of photoelectric sensors. The E3AS Series has an industry-first antifouling coating on the sensing surface which prevents water droplets and paper dust from sticking to the sensing surface and keeps the lens from fogging as well. This reduces false detections.



Air blow unit enhances the effectiveness of antifouling coating PATENTED *2

Using an air blow unit greatly reduces the frequency of false detections since it prevents the sensing surface of sensors installed in confined, difficult to clean locations from becoming contaminated. It can be mounted to any photoelectric sensor with a 25.4 mm mounting hole pitch as well as the E3AS Sensors.

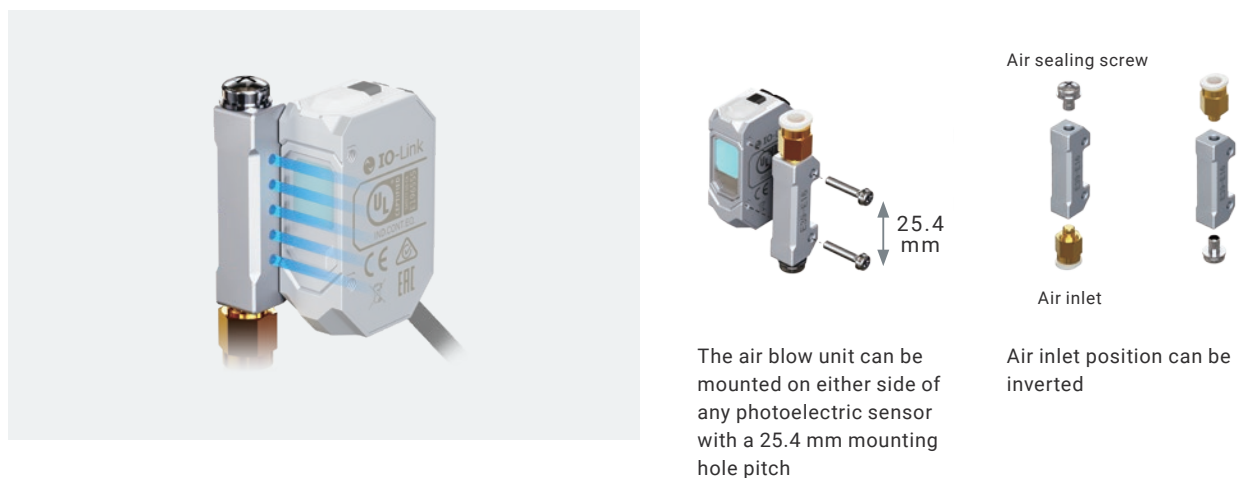

Unique case design reduces the frequency of replacements caused by failure

The sensor case is made of stainless steel (SUS316L). OMRON's unique laser welding technology for different materials enhances the sealing and adhesion between the stainless steel and resin.

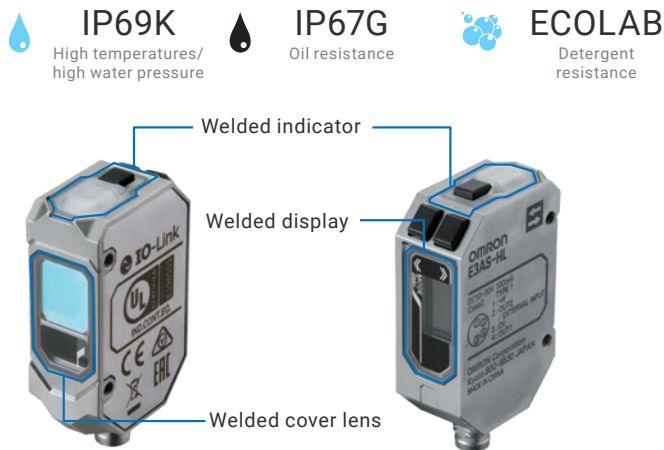

Laser welding technology for different materials PATENTED ^{*2}

It is a technology to weld different materials, resin and metal, using laser beams. Tiny holes are bored into the metal case, then the resin part is melted in by a laser for secure sealing and adhesion.

False detections due to environmental changes can be prevented CMOS E3AS-HL

False detection may occur due to the effects of lights for vision sensors or nearby sensors after the production line layout is changed.

E3AS-HL Sensors can be operated in high ambient illumination conditions and have the mutual interference prevention function, reducing the frequency of false detections.

Operation under high ambient illumination



E3AS-HL Sensors can be operated under ambient illumination of 20,000 lx, which reaches the best in class level^{*3}, preventing malfunctions caused by camera lights or sunlight.

Mutual interference prevention

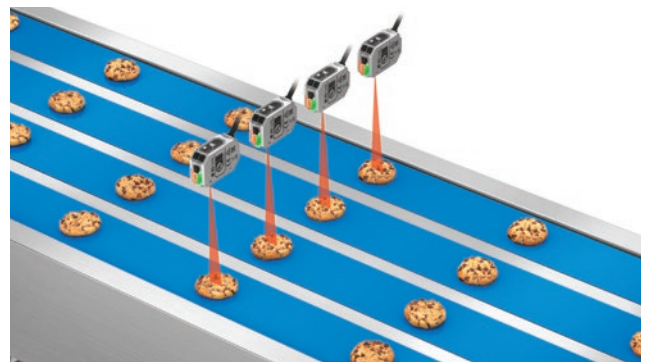

The mutual interference prevention function covers up to 4 units, allowing for false detections occurring upon sensor addition to be quickly resolved.

*1. Based on OMRON investigation in September 2019.

*2. "Patent pending" means that we applied for a patent in Japan, and "Patented" means that we obtained a patent in Japan. (As of December 2021)

*3. Based on OMRON investigation in September 2020.

Line commissioning and maintenance with less people in less time with IO-Link

With IO-Link, reduce commissioning time by batch-setting the sensors and cut troubleshooting time during mass production by utilizing field data.

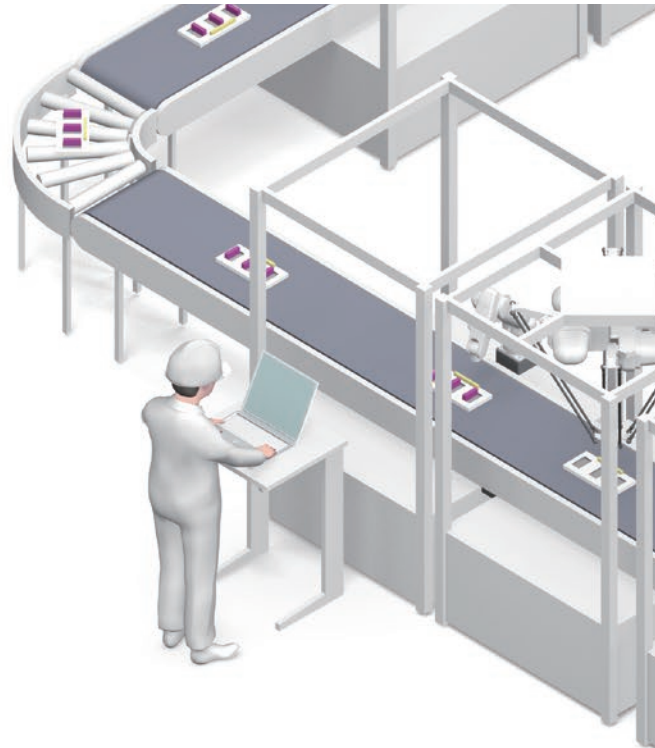
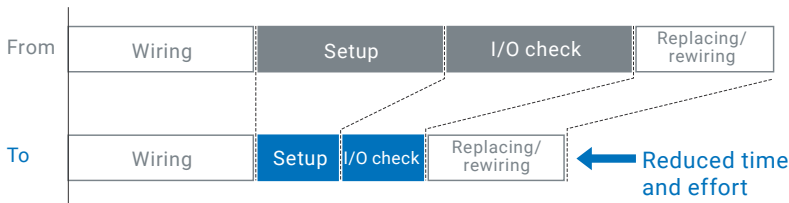

Reduce commissioning time by batch-writing settings from IO-Link device configuration tool



Setting information can be batch-written to thousands of sensors on a line, effectively reducing commissioning time and inconsistent settings.

Predictive monitoring and quick recovery by checking and monitoring sensor data

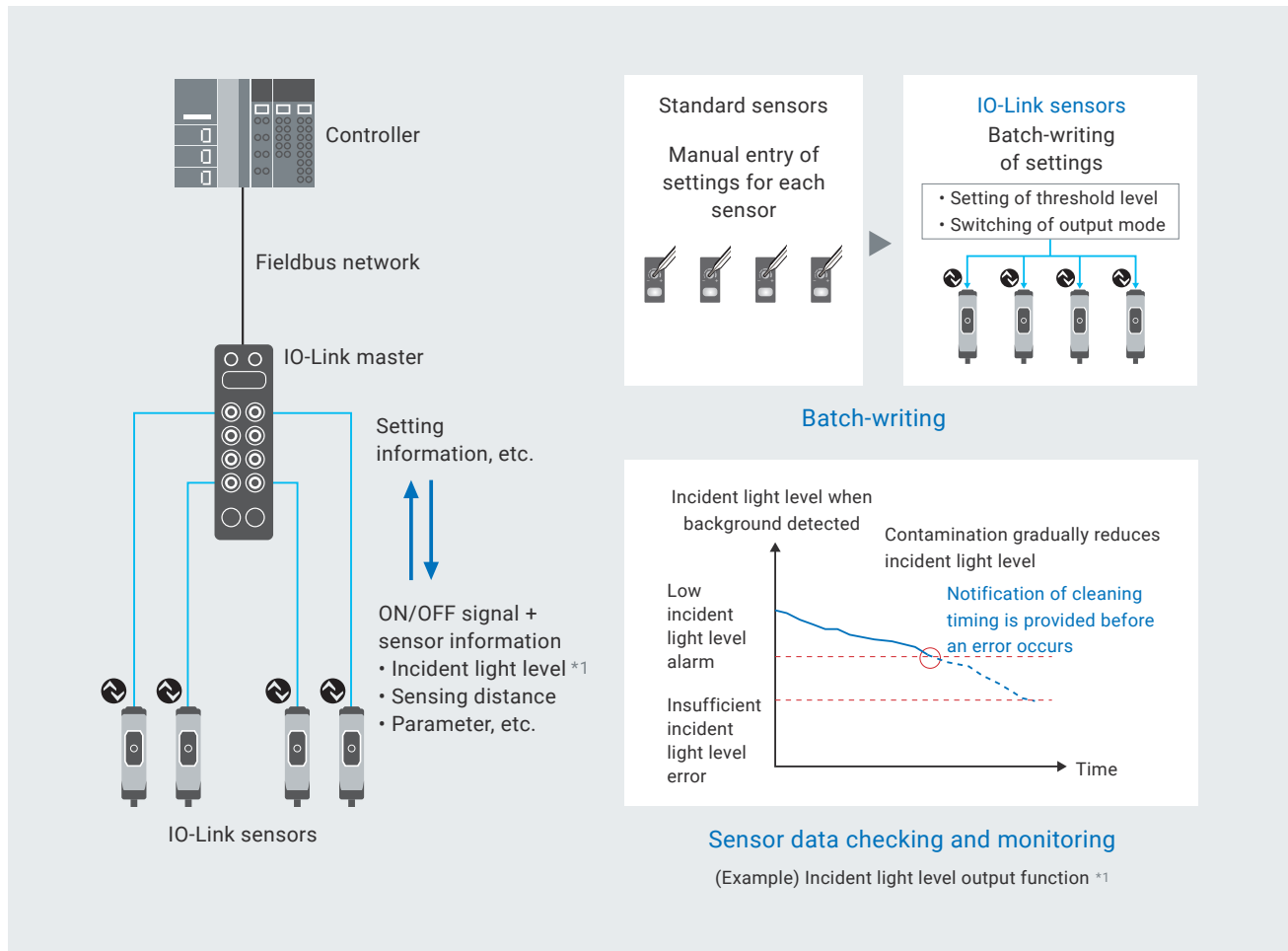
The monitor shows light intensity decrease due to sensing surface contamination or other reason, allowing users to take proactive actions to prevent potential false detections. This reduces the frequency of unexpected failures.



Model lineup

	E3AS-HL	E3AS-F	E3AS-L
Appearance			
Case	SUS316L	SUS316L or PBT/PC	SUS316L
Sensing distance	35 to 500 mm 35 to 150 mm	50 to 1500 mm 50 to 1000 mm	10 to 200 mm 10 to 80 mm
Standard detectable difference (mm)/ differential travel (%)	35 to 50 mm: 1 mm 50 to 100 mm: 2 mm 100 to 150 mm: 4 mm (E3AS-HL150: When response time is 10 ms)	15% max.	2% max. (E3AS-L80: White paper) 10% max. (E3AS-L200)
Setting method of threshold level	Teaching method/ Manual operation		Teaching method
OLED display	✓	—	—
Antifouling coating	✓	✓	✓
Mutual interference prevention function	Up to 4 units	—	—
Degree of protection	IP67/69K/67G/Ecolab		

Accessories enhance sensor usability

The E3AS Series comes with a lineup of accessories that shorten sensor adjustment time upon commissioning and reduce the frequency of false detections during production.

They can be used with non-E3AS sensors with a standard mounting hole pitch of 25.4 mm as well.

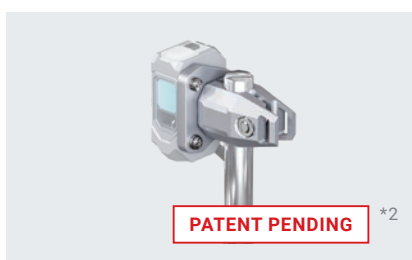

Flexible Mounting Bracket

Optical axis can be adjusted in three directions: vertical, horizontal, and angular.

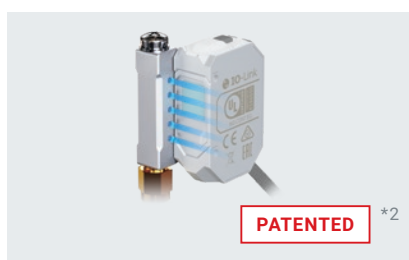

Air Blow Unit

Blows paper dust and cleaning solutions off the sensing surface.



Front Protection Cover *3

Protects sensing surfaces from collisions with workpieces, containers, and pallets.

*1. E3AS-HL and E3AS-F only

*2. "PATENT PENDING" means that we applied for a patent in Japan, and "PATENTED" means that we obtained a patent in Japan. (As of December 2021)

*3. E3AS-HL only. Note: For details on ratings and specifications, refer to the *Ratings and Specifications* in this catalog.

Applications and target workpieces



For workpieces with curved or irregular surfaces and colored, glossy workpieces

CMOS Laser Sensor E3AS-HL

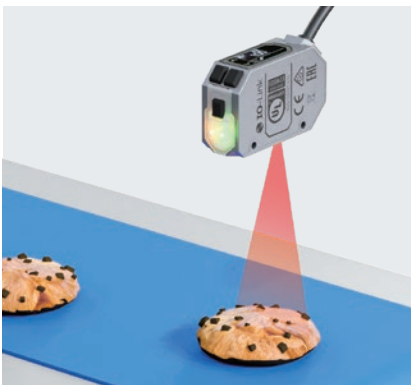

Presence detection of cookies



Presence detection of pizzas

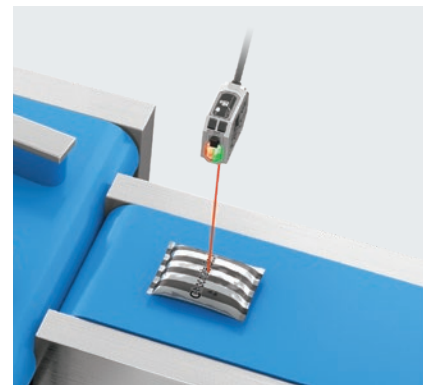

Presence detection of packaged workpieces

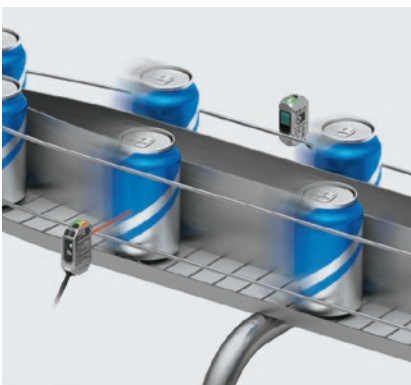

Presence detection of cans



Presence detection of plastic bottles

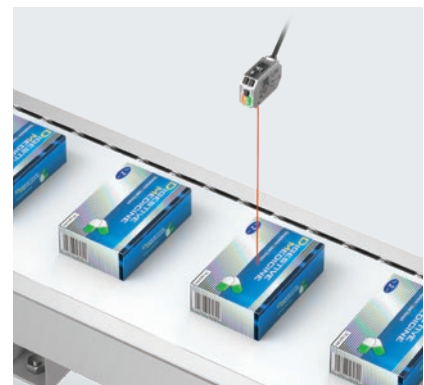

Presence detection of pharmaceutical packages

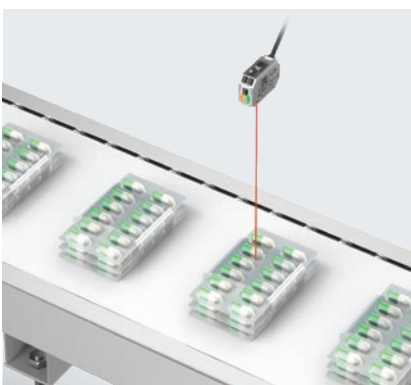

Detection of the number of tablet sheets

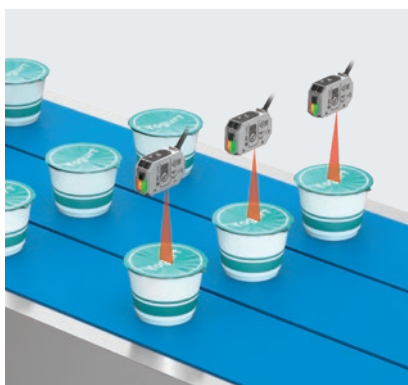

Presence detection of cups

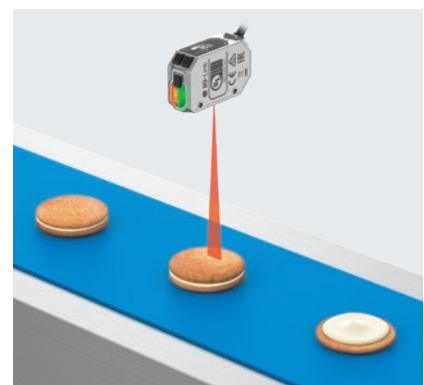

Detection of the number of cookies

Reliable detection of difficult workpieces
The demonstration videos show the detection performance.

For simple-shaped,
low-reflective workpieces

Distance-settable
Photoelectric Sensor E3AS-L



For long-distance sensing
on converging and
diverging lines

TOF Laser Sensor E3AS-F

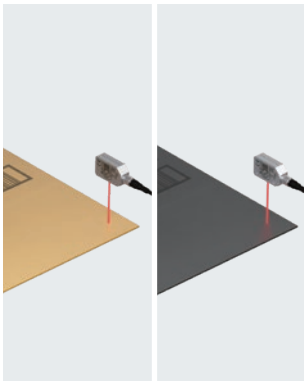

Presence detection of
unassembled cardboard boxes

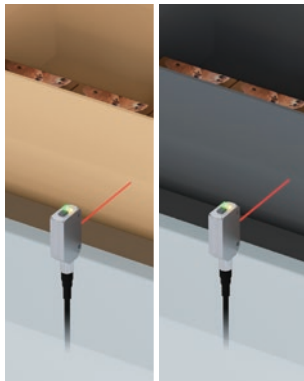

Presence detection of
assembled cardboard boxes





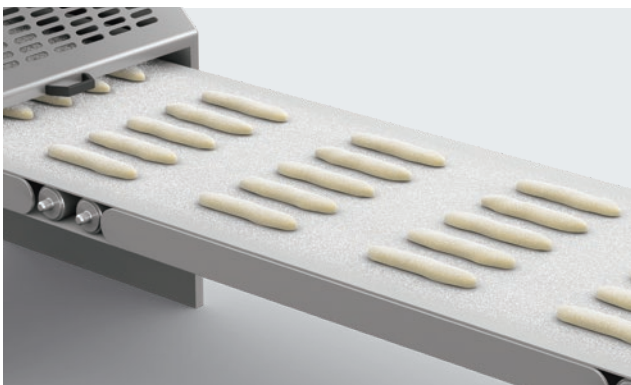

Presence detection of workpieces on converging and
diverging lines

Reliable operation even in water splashing or powder floating environments



The videos show the antifouling
feature of the antifouling coating
and air blow unit.



Water	Paper dust	Water vapor
		
Antifouling coating	Antifouling coating	Antifouling coating



Air Blow Unit

Water splashing or powder floating environments

MEMO

Distance-settable Photoelectric Sensors E3AS Series

E3AS Series changes the “way of using” reflective photoelectric sensors

- Complete lineup of photoelectric sensors for various applications
- Teaching method allows anyone to set optimal threshold values
- Antifouling coating prevents contamination on the sensing surface
- Ecolab certified in addition to IP67/69K/67G protection
- All models with IO-Link connectivity (NPN type excluded)



For the most recent information on models that have been certified for safety standards, refer to your OMRON website.

 Refer to *Safety Precautions* on page 38.

Table of Contents

Ordering Information	page 18
Ratings and Specifications	page 24
Engineering Data	page 26
I/O Circuit Diagrams/ Timing Charts	page 33
Nomenclature	page 35
Safety Precautions.....	page 38
Dimensions.....	page 40

E3AS Series

Ordering Information

E3AS-HL models [Refer to Dimensions on page 40]

Line beam type

Red light

Connection method	Sensing distance (white paper)	Output IO-Link baud rate	Model	
			NPN output ---	PNP output COM3 (230.4 kbps) *3
Pre-wired (2 m) *1			E3AS-HL500LMN 2M	E3AS-HL500LMT 2M
M8 Connector			E3AS-HL500LMN M3	E3AS-HL500LMT M3
M12 Pre-wired Smartclick Connector (0.3m) *2			E3AS-HL500LMN-M1TJ 0.3M	E3AS-HL500LMT-M1TJ 0.3M
Pre-wired (2 m) *1			E3AS-HL150LMN 2M	E3AS-HL150LMT 2M
M8 Connector			E3AS-HL150LMN M3	E3AS-HL150LMT M3
M12 Pre-wired Smartclick Connector (0.3m) *2			E3AS-HL150LMN-M1TJ 0.3M	E3AS-HL150LMT-M1TJ 0.3M

Spot type

Connection method	Sensing distance (white paper)	Output IO-Link baud rate	Model	
			NPN output ---	PNP output COM3 (230.4 kbps) *3
Pre-wired (2 m) *1			E3AS-HL500MN 2M	E3AS-HL500MT 2M
M8 Connector			E3AS-HL500MN M3	E3AS-HL500MT M3
M12 Pre-wired Smartclick Connector (0.3m) *2			E3AS-HL500MN-M1TJ 0.3M	E3AS-HL500MT-M1TJ 0.3M
Pre-wired (2 m) *1			E3AS-HL150MN 2M	E3AS-HL150MT 2M
M8 Connector			E3AS-HL150MN M3	E3AS-HL150MT M3
M12 Pre-wired Smartclick Connector (0.3m) *2			E3AS-HL150MN-M1TJ 0.3M	E3AS-HL150MT-M1TJ 0.3M

*1. Models with 5-m cable length are also available with "5M" suffix. (Example: E3AS-HL500LMN 5M/E3AS-HL500MN 5M)



*2. M8 Pre-wired Connector Models are also available. When ordering, add "-M3J 0.3M" to the end of the model number (e.g., E3AS-HL500LMN-M3J 0.3M/E3AS-HL500MN-M3J 0.3M).

*3. COM2 (38.4kbps) Models are also available. When ordering, add "D" to the end of the model number (e.g., E3AS-HL500LMD 2M/E3AS-HL500MD 2M).



E3AS-F models [Refer to Dimensions on page 41]

Metal case type

 Infrared light

Connection method	Sensing distance (white paper)	Model		
		Output	NPN output	PNP output
		IO-Link baud rate	---	COM3 (230.4 kbps) *3
Pre-wired (2 m) *1		E3AS-F1500IMN 2M	E3AS-F1500IMT 2M	
M8 Connector		E3AS-F1500IMN M3	E3AS-F1500IMT M3	
M12 Pre-wired Smartclick Connector (0.3m) *2		E3AS-F1500IMN-M1TJ 0.3M	E3AS-F1500IMT-M1TJ 0.3M	
Pre-wired (2 m) *1		E3AS-F1000IMN 2M	E3AS-F1000IMT 2M	
M8 Connector		E3AS-F1000IMN M3	E3AS-F1000IMT M3	
M12 Pre-wired Smartclick Connector (0.3m) *2		E3AS-F1000IMN-M1TJ 0.3M	E3AS-F1000IMT-M1TJ 0.3M	

Plastic case type

Connection method	Sensing distance (white paper)	Model		
		Output	NPN output	PNP output
		IO-Link baud rate	---	COM3 (230.4 kbps) *3
Pre-wired (2 m) *1		E3AS-F1500IPN 2M	E3AS-F1500IPT 2M	
M8 Connector		E3AS-F1500IPN M3	E3AS-F1500IPT M3	
M12 Pre-wired Smartclick Connector (0.3m) *2		E3AS-F1500IPN-M1TJ 0.3M	E3AS-F1500IPT-M1TJ 0.3M	
Pre-wired (2 m) *1		E3AS-F1000IPN 2M	E3AS-F1000IPT 2M	
M8 Connector		E3AS-F1000IPN M3	E3AS-F1000IPT M3	
M12 Pre-wired Smartclick Connector (0.3m) *2		E3AS-F1000IPN-M1TJ 0.3M	E3AS-F1000IPT-M1TJ 0.3M	

E3AS-L models [Refer to Dimensions on page 42]

 Red light

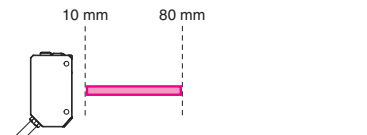
Connection method	Sensing distance (white paper)	Model		
		Output	NPN output	PNP output
		IO-Link baud rate	---	COM3 (230.4 kbps) *3
Pre-wired (2 m) *1		E3AS-L200MN 2M	E3AS-L200MT 2M	
M8 Connector		E3AS-L200MN M3	E3AS-L200MT M3	
M12 Pre-wired Smartclick Connector (0.3m) *2		E3AS-L200MN-M1TJ 0.3M	E3AS-L200MT-M1TJ 0.3M	
Pre-wired (2 m) *1		E3AS-L80MN 2M	E3AS-L80MT 2M	
M8 Connector		E3AS-L80MN M3	E3AS-L80MT M3	
M12 Pre-wired Smartclick Connector (0.3m) *2		E3AS-L80MN-M1TJ 0.3M	E3AS-L80MT-M1TJ 0.3M	

*1. Models with 5-m cable length are also available with "5M" suffix. (Example: E3AS-F1500IMN 5M/E3AS-F1500IPN 5M/E3AS-L200MN 5M)

*2. M8 Pre-wired Connector Models are also available. When ordering, add "-M3J 0.3M" to the end of the model number (e.g., E3AS-F1500IMN-M3J 0.3M/E3AS-F1500IPN-M3J 0.3M/E3AS-L200MN-M3J 0.3M).

*3. COM2 (38.4kbps) Models are also available. When ordering, add "D" to the end of the model number (e.g., E3AS-F1500IMD 2M/E3AS-F1500IPD 2M/E3AS-L200MD 2M).

E3AS Series



Accessories (Sold Separately)

Sensor I/O Connectors (Sockets on One Cable End)

(Models for Connectors / Pre-wired Connectors)



A Sensor I/O Connector is not provided with the Sensor. It must be ordered separately as required.

Round Water-resistant Connectors XS3F-M8 series

Appearance	Cable specification	Cable diameter (mm)	Cable connection direction	Cable length (m)	Sensor I/O Connector model number
M8 Connector Straight type  Right-angle type 	PVC robot cable	4 dia.	Straight	2	XS3F-M421-402-R
				5	XS3F-M421-405-R
			Right-angle	2	XS3F-M422-402-R
				5	XS3F-M422-405-R

Note: 1. The XS3W (Socket and Plug on Cable Ends), Cable length 1m and 10m is also available. Refer to XS3 Series Datasheet (Cat. No. G147).
 2. The connectors will not rotate after they are connected.
 3. The cable is fixed at an angle of 180° from the sensor emitter/receiver surface.

Round Water-resistant Connectors XS5 series









Appearance	Cable specification	Cable diameter (mm)	Cable connection direction	Cable length (m)	Sensor I/O Connector model number
M12 Smartclick Connector Straight type  Right-angle type 	PVC robot cable	6 dia.	Straight	2	XS5F-D421-D80-F
				5	XS5F-D421-G80-F
			Right-angle	2	XS5F-D422-D80-F
				5	XS5F-D422-G80-F

Note: 1. The XS5W (Socket and Plug on Cable Ends) is also available. Refer to XS5 on your OMRON website for details.
 2. The connectors will not rotate after they are connected.
 3. The cable is fixed at an angle of 180° from the sensor emitter/receiver surface.

Mounting Brackets

A Mounting Bracket is not enclosed with the Sensor. Order a Mounting Bracket separately if required.

For E3AS-HL series [Refer to *Dimensions* on page 43]

Appearance	Model (material)	Pre-wired	M12 Pre-wired Smartclick Connector	M8 Connector
L-shaped Mounting Bracket 	E39-L221 (SUS304)	Yes	Yes	---
Horizontal Protective Cover Bracket 	E39-L222 (SUS304)	Yes	Yes	---
Rear Mounting Bracket 	E39-L223 (SUS304)	Yes	Yes	Yes *2
Robust Mounting Bracket 	E39-L224 (SUS304)	Yes	Yes	---
L-shaped Mounting Bracket 	E39-L231 (SUS304)	--- *1	--- *1	Yes *3
Horizontal Protective Cover Bracket 	E39-L232 (SUS304)	--- *1	--- *1	Yes *3
Robust Mounting Bracket 	E39-L234 (SUS304)	--- *1	--- *1	Yes *3
Front Protection Cover 	E39-E19 *4	Yes	Yes	Yes

*1. Can be used for Pre-wired models and M12 Pre-wired Smartclick Connector models. However, confirm the bracket shape in advance.







*2. Confirm the installation environment and bracket shape of the Sensor I/O Connector to be connected.

*3. Use an L-shaped Sensor I/O Connector. Straight types cannot be installed.

*4. Front Protection Cover is Accessory for E3AS-HL. E3AS-F model and E3AS-L model cannot be installed.

E3AS Series

For E3AS-F/L models [Refer to *Dimensions* on page 47]

Appearance	Model (material)	Pre-wired	M12 Pre-wired Smartclick Connector	M8 Connector
L-shaped Mounting Bracket 	E39-L201 (SUS304)	Yes	Yes	---
Horizontal Protective Cover Bracket 	E39-L202 (SUS304)	Yes	Yes	---
Rear Mounting Bracket 	E39-L203 (SUS304)	Yes	Yes	Yes *2
Robust Mounting Bracket 	E39-L204 (SUS304)	Yes	Yes	---
L-shaped Mounting Bracket 	E39-L211 (SUS304)	--- *1	--- *1	Yes *3
Horizontal Protective Cover Bracket 	E39-L212 (SUS304)	--- *1	--- *1	Yes *3
Robust Mounting Bracket 	E39-L214 (SUS304)	--- *1	--- *1	Yes *3





*1. Can be used for Pre-wired models and M12 Pre-wired Smartclick Connector models. However, confirm the bracket shape in advance.

*2. Confirm the installation environment and bracket shape of the Sensor I/O Connector to be connected.

*3. Use an L-shaped Sensor I/O Connector. Straight types cannot be installed.

Common to E3AS series [Refer to *Dimensions* on page 50]

A Mounting Bracket is not enclosed with the Sensor. Order a Mounting Bracket separately if required.

Appearance	Model (material)	Pre-wired	M12 Pre-wired Smartclick Connector	M8 Connector
Flexible Mounting Bracket 	E39-L261 *1 (SUS304)	Yes	Yes	Yes
Post 50 mm 	E39-L262	Yes	Yes	Yes
Post 100 mm 	E39-L263	Yes	Yes	Yes
Air Blow Unit 	E39-E16 *2	Yes	Yes	Yes

*1. The Flexible Mounting Bracket is not provided with a Post (E39-L262/E39-L263). It must be ordered separately.

*2. The tube for air is not included.

E3AS Series

Ratings and Specifications

E3AS-HL models

Item	Model	Sensing method		Triangulation			
		Type		Metal case (□: M), Plastic case (□: P)			
		NPN Output	PNP Output/COM3	E3AS-HL500MN	E3AS-HL500LMN	E3AS-HL150MN	E3AS-HL150LMN
				E3AS-HL500MT	E3AS-HL500LMT	E3AS-HL150MT	E3AS-HL150LMT
Sensing distance *1		35 mm to the set distance				35 mm to the set distance	
Setting range *1		35 to 500 mm				35 to 150 mm	
Standard detectable difference *1		35 to 180 mm: 9 mm 180 to 300 mm: 18 mm 300 to 400 mm: 30 mm 400 to 500 mm: 45 mm at 10 m sec				35 to 50 mm: 1 mm 50 to 100 mm: 2 mm 100 to 150 mm: 4 mm at 10 m sec	
Display minimum unit value		1 mm				0.1 mm	
Spot size (reference value) *2		2.5 mm × 1.5 mm at distance of 500 mm		18 mm × 1.5 mm at distance of 500 mm		2.5 mm × 1.3 mm at distance of 150 mm	
Light source (wavelength)		Red laser (660 nm), Class1 (IEC/EN60825-1:2014)					
Power supply voltage		10 to 30 VDC (including 10% ripple (p-p)), Class2					
Current consumption		100 mA max.					
Input/ output	Control output		Load power supply voltage 30 VDC max. (Class2), the total load current of the two outputs is 100 mA max. Residual voltage (Load current 10 mA max.: 1 VDC max., Load current 10 to 100 mA: 2 VDC max.) Open-collector output (NPN/PNP output depending on model) N.O. (Normally Open) / N.C. (Normally Close) selectable				
	NPN		OUTPUT 1: NO (Normally open), OUTPUT 2: NC (Normally closed)				
	PNP/COM3		OUTPUT 1: NO (Normally open)/COM□, OUTPUT 2: NC (Normally closed)				
External input		Laser OFF / Teaching / Zero reset selectable NPN ON time: 0 V short-circuit or 1.5 V or less, OFF time: Power supply voltage short-circuit or open PNP ON time: Power supply voltage short-circuit or within power supply voltage - 1.5 V, OFF time: 0 V short-circuit or open					
Response time		1.5 ms / 10 ms / 50 ms selectable					
Threshold setting method		Teaching method / Manual Operations / IO-Link communications					
Mutual interference prevention		4 units max. (when using the mutual interference prevention function)					
Ambient illumination		Receiver surface illuminance: Incandescent lamp: 20,000 lx max., Sunlight: 25,000 lx max. at distance of 250 mm Incandescent lamp: 5,000 lx max., Sunlight: 10,000 lx max. at distance of 500 mm				Receiver surface illuminance: Incandescent lamp: 8,000 lx max., Sunlight: 16,000 lx max.	

*1. Measured with OMRON's standard workpiece (White ceramic).

*2. Defined by D4σ method at the maximum sensing distance. Detection may be influenced if there is light leakage outside the defined region and the surroundings of the target object have a high reflectance in comparison to the target object. Also, when detecting a workpiece that is smaller than the spot size, a correct value may not be obtained.

E3AS-F models

Item	Model	Sensing method		TOF (Time of flight)			
		Type		Metal case (□: M), Plastic case (□: P)			
		NPN output	PNP output/ COM3	E3AS-F1500I□N	E3AS-F1000I□N		
				E3AS-F1500I□T	E3AS-F1000I□T		
Sensing distance		50 mm to the set distance (White paper or black paper 200 × 200 mm)				50 mm to the set distance (White paper or black paper 200 × 200 mm)	
Setting range		100 to 1,500 mm (White paper 200 × 200 mm) 100 to 1,000 mm (Black paper 200 × 200 mm)				100 to 1,000 mm (White paper 200 × 200 mm) 100 to 500 mm (Black paper 200 × 200 mm)	
Spot diameter (reference value)		95 mm dia. (at distance of 1,000 mm)					
Differential travel		15% max. of set distance (Set distance 200 mm min.)					
Reflectivity characteristic (black/white error)		10% max. of set distance (Set distance 200 mm min.)					
Light source (wavelength)		Infrared laser (940 nm) Class1 (IEC/EN60825-1:2014)					
Power supply voltage		10 to 30 VDC (including 10% ripple (p-p)), Class2					
Current consumption		30 mA max.					
Input/ output	Control output		Load power supply voltage: 30 VDC max., Class2, Load current: 100 mA max. (Residual voltage: Load current of less than 10 mA: 1 V max. Load current of 10 to 100 mA: 2 V max.) Open-collector output (NPN/PNP output depending on model)				
	NPN		OUTPUT 1: NO (Normally open), OUTPUT 2: NC (Normally closed)				
	PNP/COM3		OUTPUT 1: NO (Normally open)/COM□, OUTPUT 2: NC (Normally closed)				
Response time		Operate or reset: 150 ms max.				Operate or reset: 90 ms max.	
Threshold setting method		Teaching method/IO-Link communications					
Ambient illumination		Incandescent lamp: 3,000 lx max., Sunlight: 10,000 lx max.					

E3AS-L models

Item	Sensing method		Triangulation	
	Model	NPN Output	E3AS-L200MN	E3AS-L80MN
		PNP Output/COM3	E3AS-L200MT	E3AS-L80MT
Sensing distance		10 mm to the set distance (White paper or black paper 100 × 100 mm)		
Setting range		40 to 200 mm (White paper or black paper 100 × 100 mm)		20 to 80 mm (White paper or black paper 100 × 100 mm)
Spot diameter (reference value)		25 × 25 mm at distance of 200 mm		4 mm dia. (at distance of 80 mm)
Differential travel		10% max. of set distance		White paper: 2% max. of set distance Black paper: 5% max. of set distance
Reflectivity characteristic (black/white error)		10% max. of set distance		5% max. of set distance
Light source (wavelength)		Red LED (624 nm)		Red LED (650 nm)
Power supply voltage		10 to 30 VDC (including 10% ripple (p-p)), Class2		
Current consumption		35 mA max.		
Input/output	Control output		Load power supply voltage: 30 VDC max., Class2, Load current: 100 mA max. (Residual voltage: Load current of less than 10 mA: 1 V max. Load current of 10 to 100 mA: 2 V max.) Open-collector output (NPN/PNP output depending on model)	
	NPN		OUTPUT 1: NO (Normally open), OUTPUT 2: NC (Normally closed)	
	PNP/COM3		OUTPUT 1: NO (Normally open)/COM□, OUTPUT 2: NC (Normally closed)	
Response time		Operate or reset: 1 ms max.		
Threshold setting method		Teaching method/IO-Link communications		
Ambient illumination		Incandescent lamp: 3,000 lx max., Sunlight: 10,000 lx max.		

Common to E3AS series

Series	E3AS-HL	E3AS-F	E3AS-L	
Protection circuits	Power supply reverse polarity protection, Output short-circuit protection, and Output reverse polarity protection			
Ambient temperature range	Operating: -10 to 50°C, Storage: -25 to 70°C (with no icing or condensation)	Operating: -20 to 55°C, Storage: -40 to 70°C (with no icing or condensation)	Operating: -25 to 55°C, Storage: -40 to 70°C (with no icing or condensation)	
Ambient humidity range	Operating: 35% to 85%, Storage: 35% to 95% (with no condensation)			
Insulation resistance	20 MΩ min. at 500 VDC			
Dielectric strength	1,000 VAC, 50/60 Hz for 1 min			
Vibration resistance	10 to 55 Hz with a 1.5-mm double amplitude for 2 hours each in X, Y, and Z directions			
Shock resistance	500 m/s ² for 3 times each in X, Y, and Z directions			
Degree of protection	IP67 (IEC60529) and IP67G *1 (JIS C 0920 Annex 1), IP69K (ISO20653)			
Indicators	OLED Display (White), Power/Communication indicator (Green*), Operation indicator (Orange) * IO-Link Communication mode: blinking	Operation indicator (orange), Stability & Communication indicator (green*) * IO-Link Communication mode: blinking		
Connection method	Pre-wired (standard cable length: 2 m), M8 Connector, M12 Pre-wired Smartclick Connector (standard cable length: 0.3m)			
Weight (packed state/Sensor only)	Pre-wired (2 m)	Approx. 180 g/approx. 110 g	Metal case type: Approx. 135 g/approx. 90 g Plastic case type: Approx. 115 g/approx. 70 g	Approx. 135 g/approx. 90 g
	M8 Connector	Approx. 120 g/approx. 50 g	Metal case type: Approx. 75 g/approx. 30 g Plastic case type: Approx. 60 g/approx. 15 g	Approx. 75 g/approx. 30 g
	M12 Pre-wired Smartclick Connector (0.3m)	Approx. 150 g/approx. 80 g	Metal case type: Approx. 95 g/approx. 50 g Plastic case type: Approx. 75 g/approx. 30 g	Approx. 95 g/approx. 50 g
Materials	Case	Stainless steel (SUS316L)	Metal case type: Main unit/mounting part/connector part Stainless steel (SUS316L) Plastic case type: Main unit Polybutylene terephthalate (PBT) / polycarbonate (PC), Mounting part/connector part Nickel-plated brass	Stainless steel (SUS316L)
	Lens cover and Display	Methacrylic resin (PMMA) (Lens cover: Antifouling coating)		
	Indicator	Polyamide 11 (PA11)	Metal case type: Polyamide 11 (PA11) Plastic case type: Polyethersulfone (PES)	Polyamide 11 (PA11)
Main IO-Link functions	Operation mode switching between NO and NC, execution of teaching (2-point teaching, Background teaching), setup of the threshold, timer function of the control output and timer time selecting, Restore Factory Settings, Key Lock (Unlock, Lock, Lock (No Button)), monitor output* (Detection level, Incident light level) * Only for E3AS-HL and E3AS-F			
IO-Link Communication specifications	IO-Link specification	Ver. 1.1		
	Baud rate	COM3 (230.4 kbps)		
	Data length	PD size: 4 bytes, OD size: 1 byte (M-sequence type: TYPE_2_V)	PD size: 1 byte, OD size: 1 byte (M-sequence type: TYPE_2_1)	
	Minimum cycle time	COM3: 1.2 ms		
Accessories	Instruction manual, compliance sheet, index list (attached for IO-Link type only) E3AS-HL: FDA certification label and Warning label E3AS-F: FDA certification label Note: Mounting Brackets must be ordered separately.			

*1. The IP67G is the degree of protection which is defined according to the JIS (Japanese Industrial Standards).

The IP67 indicates the same level of protection as defined by the IEC, and the G indicates that a device has resistance to oil.

E3AS Series

Engineering Data (Reference Value)

E3AS-HL models

Spot Diameter vs. Sensing Distance

Spot type

E3AS-HL500□

E3AS-HL150□

Line beam type

E3AS-HL500L□

E3AS-HL150L□

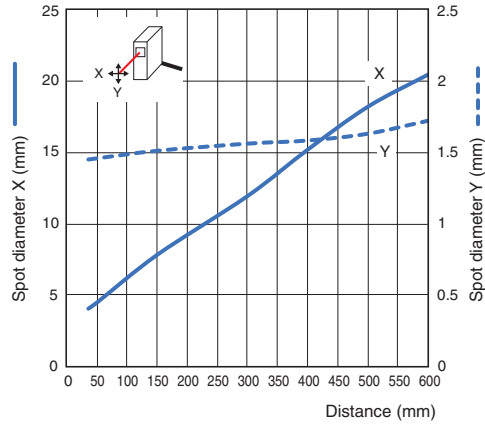
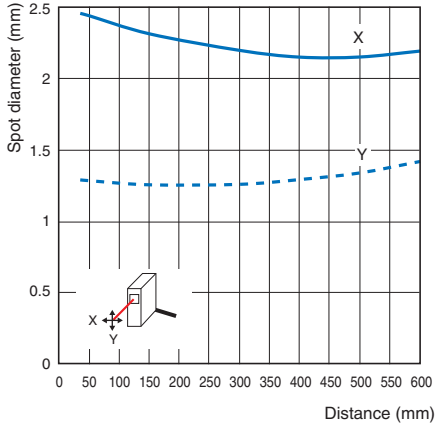

Sensing Object Angle Characteristics

Spot type/Line beam type

E3AS-HL500□

Horizontal

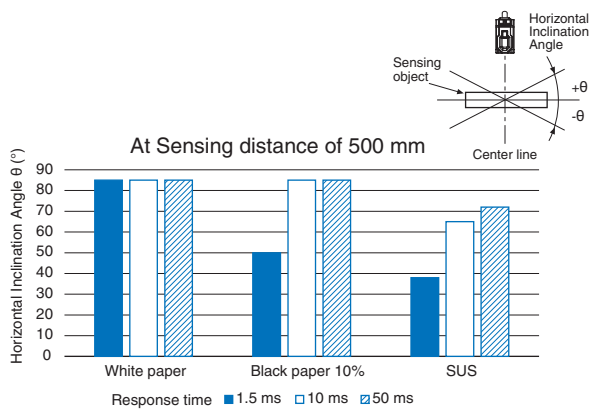
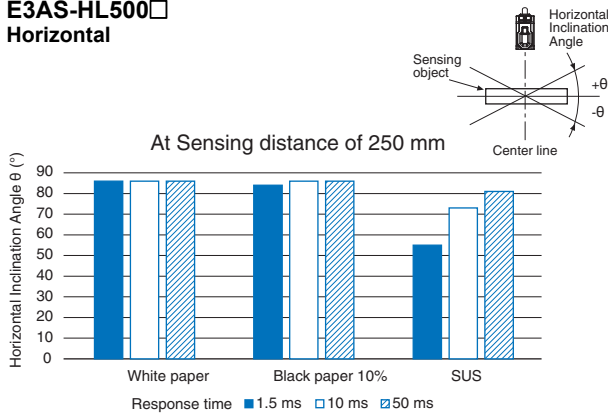

E3AS-HL150□

Horizontal

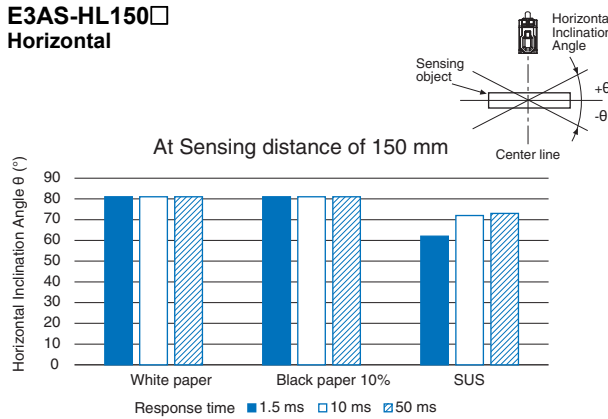

Minimum Measurement Gap Vs. Distance

Spot type/Line beam type

E3AS-HL500□

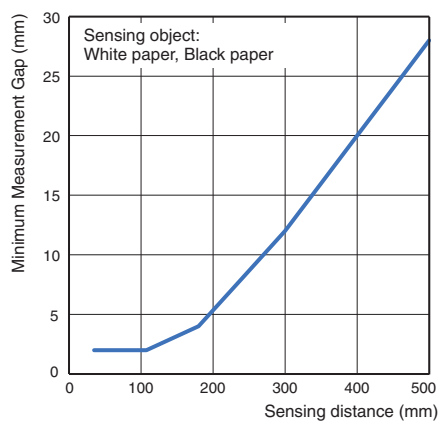

E3AS-HL150□

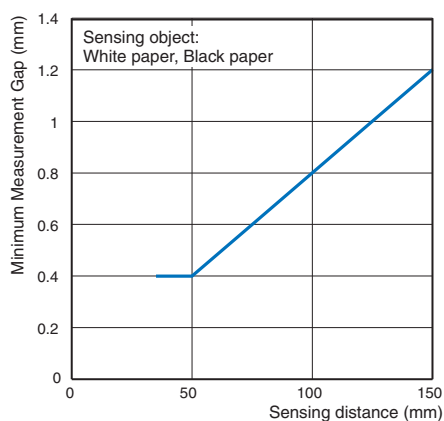

E3AS-F models

Operating Range

E3AS-F1500□

Z directions

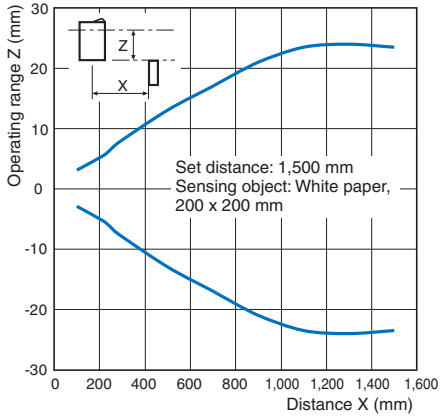

Y directions

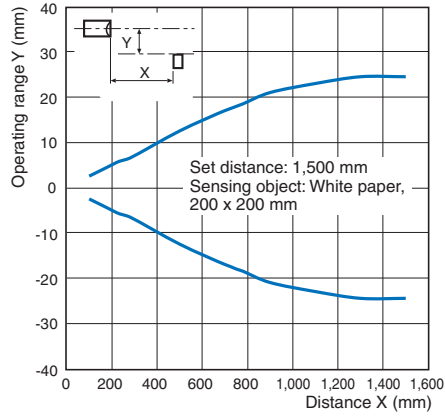

E3AS-F1000□

Z directions

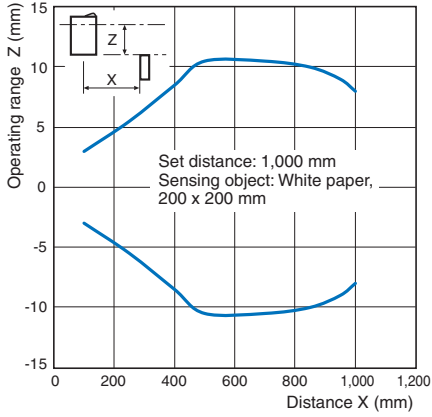

Y directions

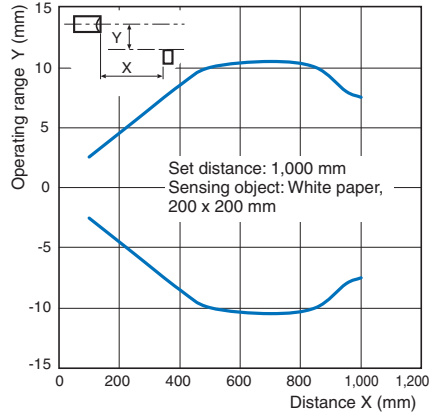

Spot Diameter vs. Sensing Distance

E3AS-F1500□

E3AS-F1000□

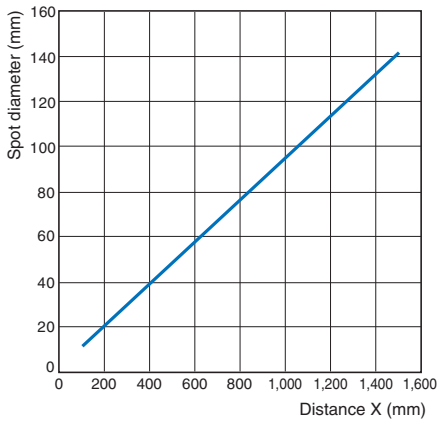

Close-range Characteristics

E3AS-F1500□

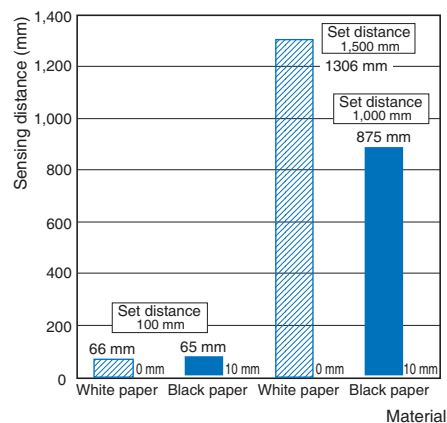

E3AS-F1000□

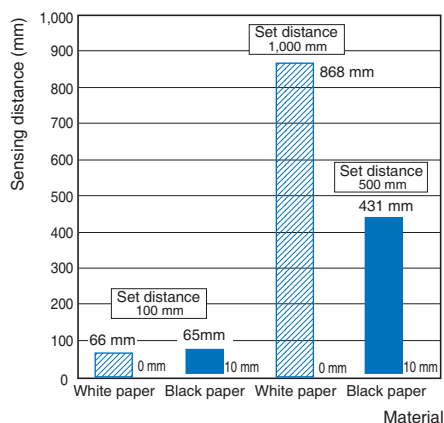

Differential distance for each sensing object Vs. Distance

E3AS-F1500□

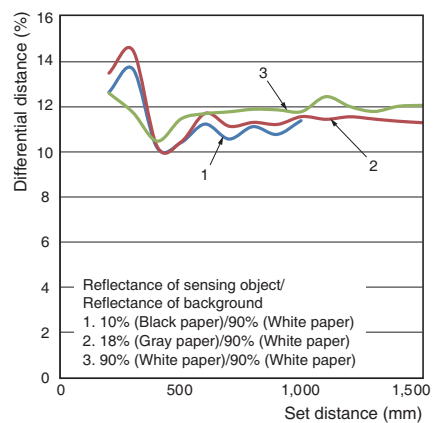

E3AS-F1000□

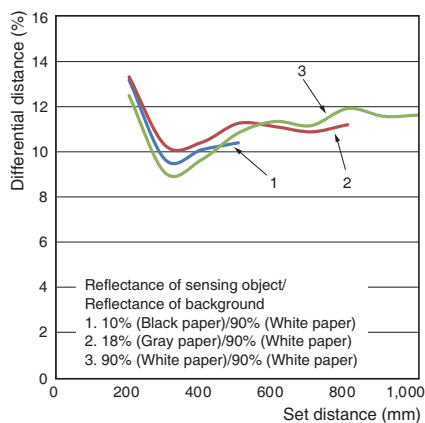

Sensing Object Angle Characteristics

E3AS-F1500□

Vertical

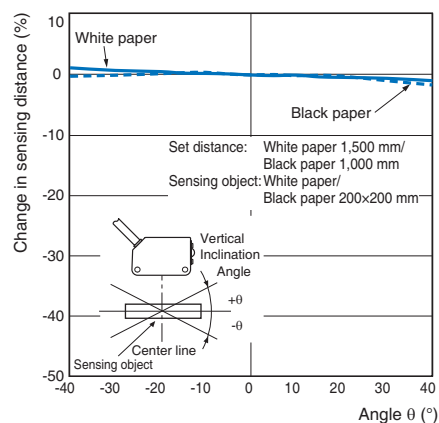

Horizontal

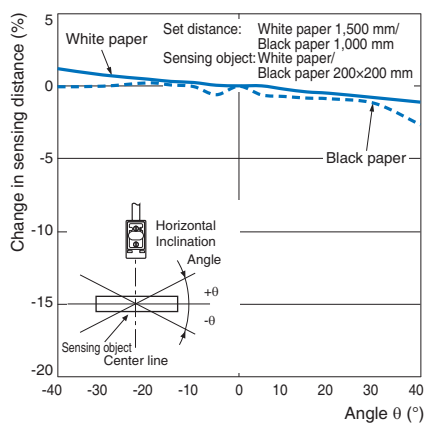

E3AS-F1000□

Vertical

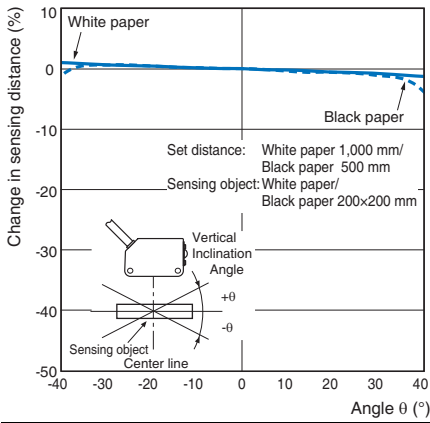

Horizontal

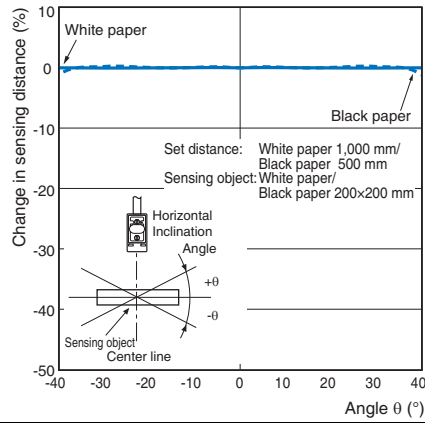

Sensing Distance vs. Sensing Object Material

E3AS-F1500□

(Set Distance of 1,500 mm using White Paper)

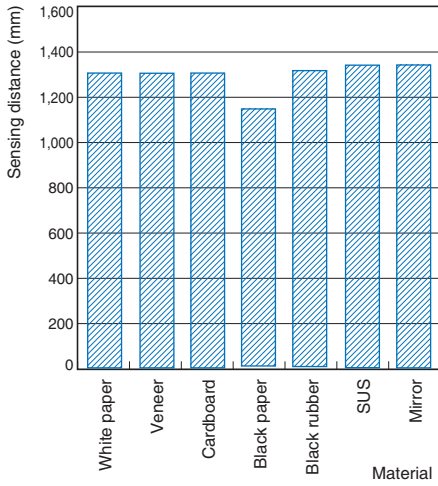

E3AS-F1000□

(Set Distance of 1,000 mm using White Paper)

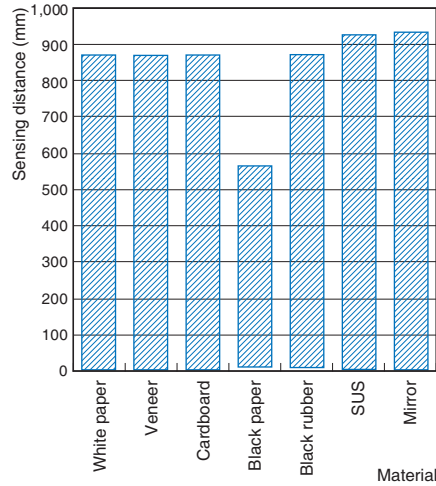

Sensing Object Size vs. Sensing Distance

E3AS-F1500□

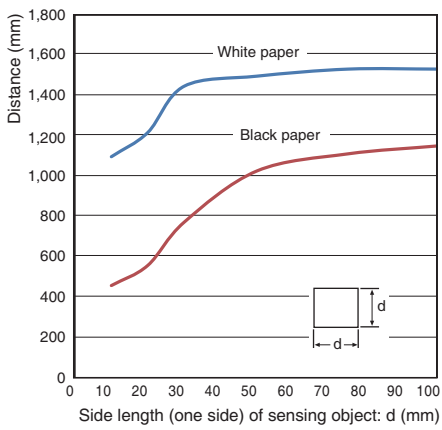

E3AS-F1000□

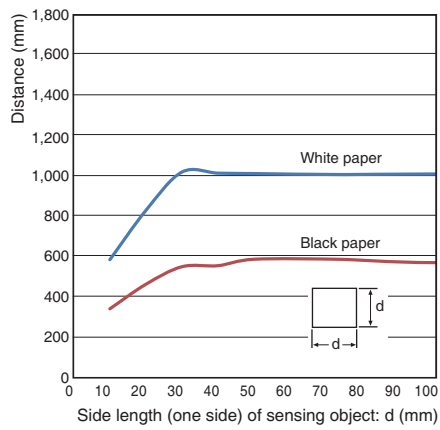

E3AS-L models

Operating Range

E3AS-L200

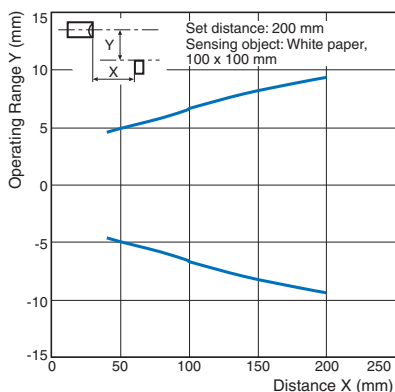

E3AS-L80

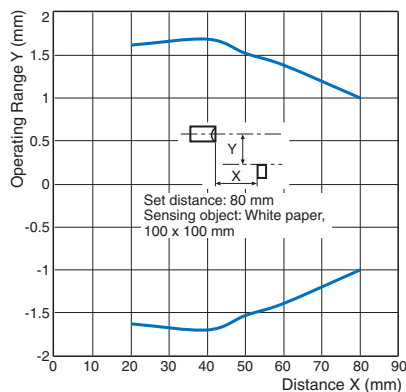

Spot Diameter vs. Sensing Distance

E3AS-L200

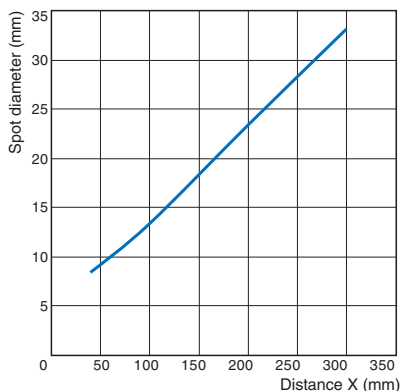

E3AS-L80

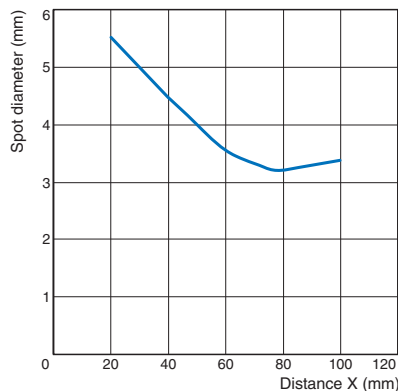

Close-range Characteristics

E3AS-L200

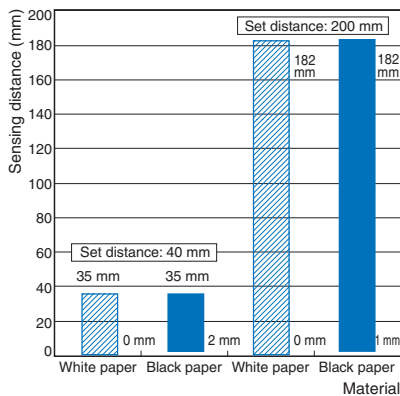

E3AS-L80

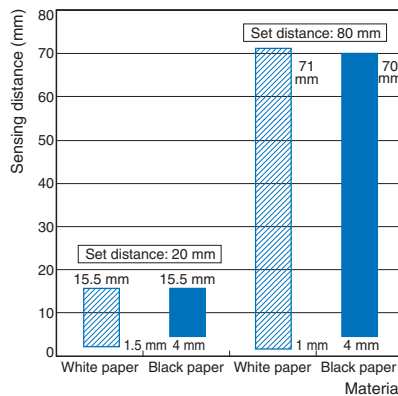

Differential distance for each sensing object Vs. Distance

E3AS-L200

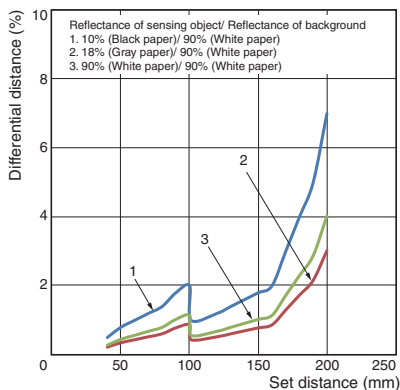

E3AS-L80

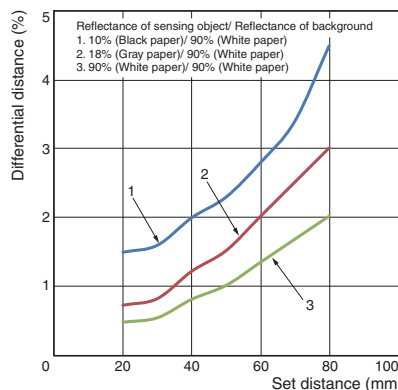

Sensing Object Angle Characteristics

E3AS-L200

Vertical

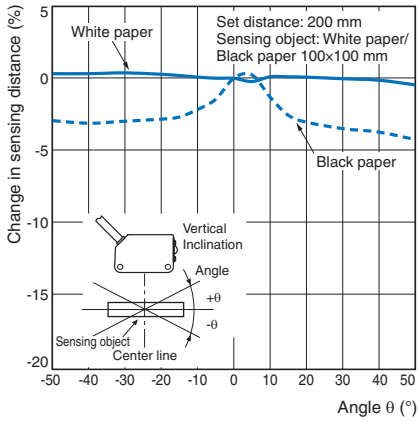

Horizontal

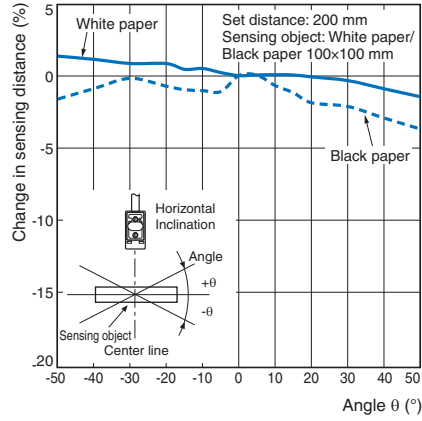

E3AS-L80

Vertical

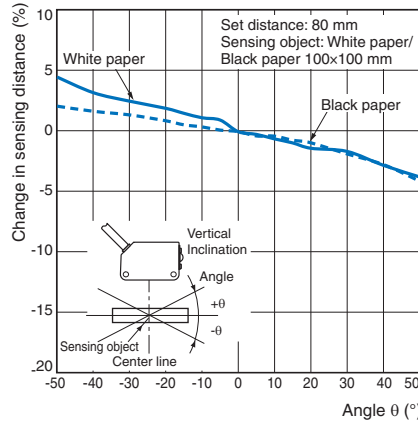

Horizontal

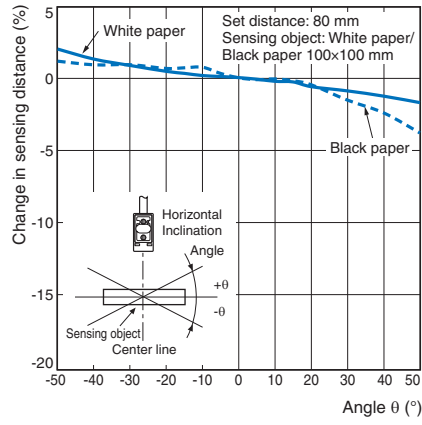

Sensing Distance vs. Sensing Object Material

E3AS-L200

(Set Distance of 200 mm using White Paper)

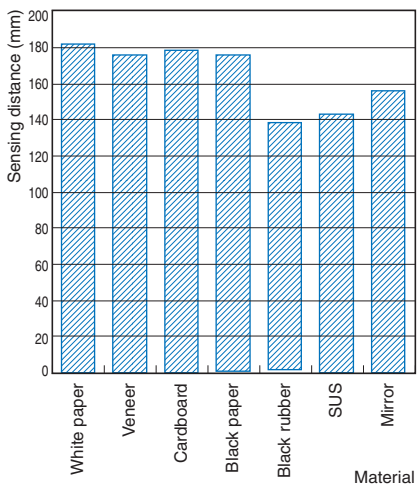

E3AS-L80

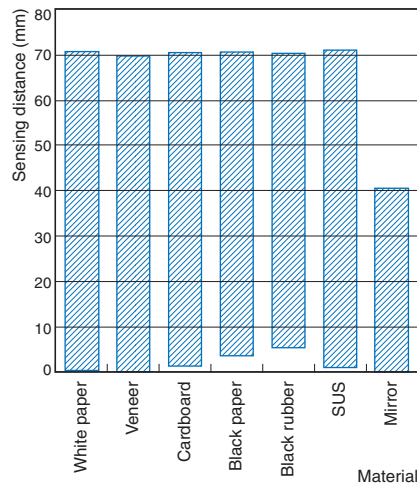

(Set Distance of 80 mm using White Paper)



I/O Circuit Diagrams/ Timing Charts

E3AS-HL models

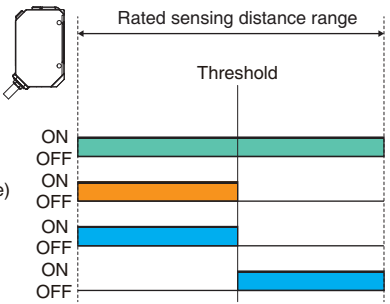
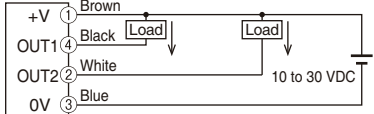
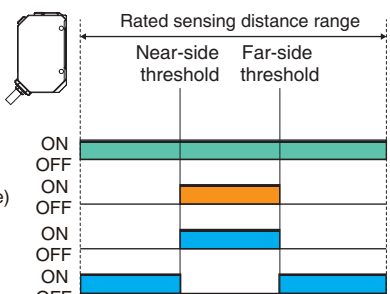
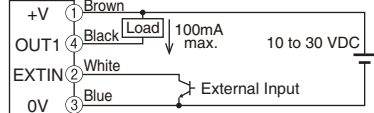
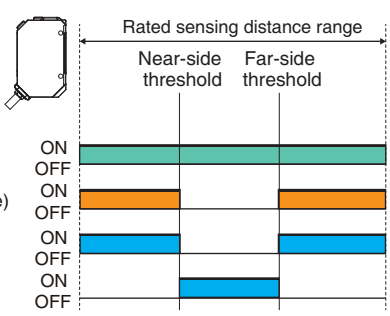
NPN Output

Model	Timing chart	Output circuit						
E3AS-HL500□N□ E3AS-HL150□N□	<p>Single Point Mode [Single]</p>  <p>Power/Communication indicator (green) ON OFF</p> <p>Operation indicator (orange) ON OFF</p> <p>Control output 1 ON OFF</p> <p>Control output 2 * ON OFF</p>	<p>Using Pin2 (white wire) as output</p>  <p>Total load current of the two output routes must be 100 mA or less.</p>						
	<p>Window BGS mode [Window BGS]</p>  <p>Power/Communication indicator (green) ON OFF</p> <p>Operation indicator (orange) ON OFF</p> <p>Control output 1 ON OFF</p> <p>Control output 2 * ON OFF</p>	<p>Using Pin2 (white wire) as external input</p>  <table border="1" data-bbox="1053 739 1460 851"> <thead> <tr> <th>External Input</th> <th>NPN</th> </tr> </thead> <tbody> <tr> <td>ON time</td> <td>0V short-circuit or 1.5V or less</td> </tr> <tr> <td>OFF time</td> <td>Power supply voltage short-circuit or open</td> </tr> </tbody> </table>	External Input	NPN	ON time	0V short-circuit or 1.5V or less	OFF time	Power supply voltage short-circuit or open
	External Input	NPN						
ON time	0V short-circuit or 1.5V or less							
OFF time	Power supply voltage short-circuit or open							
<p>Window FGS mode [Window FGS]</p>  <p>Power/Communication indicator (green) ON OFF</p> <p>Operation indicator (orange) ON OFF</p> <p>Control output 1 ON OFF</p> <p>Control output 2 * ON OFF</p>	<p>Connector Pin Arrangement</p> <p>M12 Pre-wired Smartclick Connector</p>  <p>M8 Connector</p> 							

* The initial value of control output 2 is reverse of control output 1.

PNP Output

Model	Output circuit						
	Standard I/O mode (SIO mode) *1	IO-Link Communication mode (COM mode) *2					
E3AS-HL500□□□ E3AS-HL150□□□	<p>Using Pin2 (white wire) as output</p>	<p>Using Pin2 (white wire) as output</p>					
	<p>Using Pin2 (white wire) as external input</p> <table border="1"> <thead> <tr> <th>External Input</th> <th>PNP</th> </tr> </thead> <tbody> <tr> <td>ON time</td> <td>Power supply voltage short-circuit or within power supply voltage - 1.5V</td> </tr> <tr> <td>OFF time</td> <td>0V short-circuit or open</td> </tr> </tbody> </table>	External Input	PNP	ON time	Power supply voltage short-circuit or within power supply voltage - 1.5V	OFF time	0V short-circuit or open
External Input	PNP						
ON time	Power supply voltage short-circuit or within power supply voltage - 1.5V						
OFF time	0V short-circuit or open						
<p>Connector Pin Arrangement</p> <div style="display: flex; justify-content: space-around;"> <div style="text-align: center;"> <p>M12 Pre-wired Smartclick Connector</p> </div> <div style="text-align: center;"> <p>M8 Connector</p> </div> </div>							

*1. Standard I/O mode is used as PNP ON/OFF output.

*2. IO-Link Communication mode is used for communications with the IO-Link Master. C/Q performs IO-Link communications. Sensor output DO performs ON/OFF output.

Single Point Mode [Single]

Timing charts																									
Output mode																									
Standard I/O mode (SIO mode)	<table border="0"> <tr> <td>Power/Communication indicator (green)</td> <td>ON</td> <td>[Green bar]</td> </tr> <tr> <td></td> <td>OFF</td> <td>[Green bar]</td> </tr> <tr> <td>Operation indicator (orange)</td> <td>ON</td> <td>[Orange bar]</td> </tr> <tr> <td></td> <td>OFF</td> <td>[Orange bar]</td> </tr> <tr> <td>Control output 1 *2</td> <td>ON</td> <td>[Blue bar]</td> </tr> <tr> <td></td> <td>OFF</td> <td>[Blue bar]</td> </tr> <tr> <td>Control output 2 *1, *2</td> <td>ON</td> <td>[Blue bar]</td> </tr> <tr> <td></td> <td>OFF</td> <td>[Blue bar]</td> </tr> </table>	Power/Communication indicator (green)	ON	[Green bar]		OFF	[Green bar]	Operation indicator (orange)	ON	[Orange bar]		OFF	[Orange bar]	Control output 1 *2	ON	[Blue bar]		OFF	[Blue bar]	Control output 2 *1, *2	ON	[Blue bar]		OFF	[Blue bar]
	Power/Communication indicator (green)	ON	[Green bar]																						
		OFF	[Green bar]																						
	Operation indicator (orange)	ON	[Orange bar]																						
	OFF	[Orange bar]																							
Control output 1 *2	ON	[Blue bar]																							
	OFF	[Blue bar]																							
Control output 2 *1, *2	ON	[Blue bar]																							
	OFF	[Blue bar]																							
IO-Link Communication mode (COM mode)	<table border="0"> <tr> <td>Power/Communication indicator (green)</td> <td>Flashing (1 second cycle)</td> <td>[Flashing green bar]</td> </tr> <tr> <td></td> <td>ON</td> <td>[Green bar]</td> </tr> <tr> <td></td> <td>OFF</td> <td>[Green bar]</td> </tr> <tr> <td>Communication output</td> <td>1</td> <td>[Yellow bar]</td> </tr> <tr> <td></td> <td>0</td> <td>[Yellow bar]</td> </tr> <tr> <td>Control output 2 *1, *2</td> <td>ON</td> <td>[Blue bar]</td> </tr> <tr> <td></td> <td>OFF</td> <td>[Blue bar]</td> </tr> </table>	Power/Communication indicator (green)	Flashing (1 second cycle)	[Flashing green bar]		ON	[Green bar]		OFF	[Green bar]	Communication output	1	[Yellow bar]		0	[Yellow bar]	Control output 2 *1, *2	ON	[Blue bar]		OFF	[Blue bar]			
	Power/Communication indicator (green)	Flashing (1 second cycle)	[Flashing green bar]																						
		ON	[Green bar]																						
		OFF	[Green bar]																						
Communication output	1	[Yellow bar]																							
	0	[Yellow bar]																							
Control output 2 *1, *2	ON	[Blue bar]																							
	OFF	[Blue bar]																							

- *1. The initial value of control output 2 is reverse of control output 1.
- *2. The timer function of the control output can be set up by the IO-Link communications. (It is able to select ON delay, OFF delay, or one-shot function and select a timer time of 1 to 9,999 ms (T).)

ON delay		OFF delay		One Shot	
Sensing object	Present	Sensing object	Present	Sensing object	Present
	Not present		Not present		Not present
NO	ON 1	NO	ON 1	NO	ON 1
	OFF 0		OFF 0		OFF 0
NC	ON 1	NC	ON 1	NC	ON 1
	OFF 0		OFF 0		OFF 0

Please contact your OMRON sales representative regarding the IO-Link setup file (IODD file).

Window BGS mode [Window BGS]

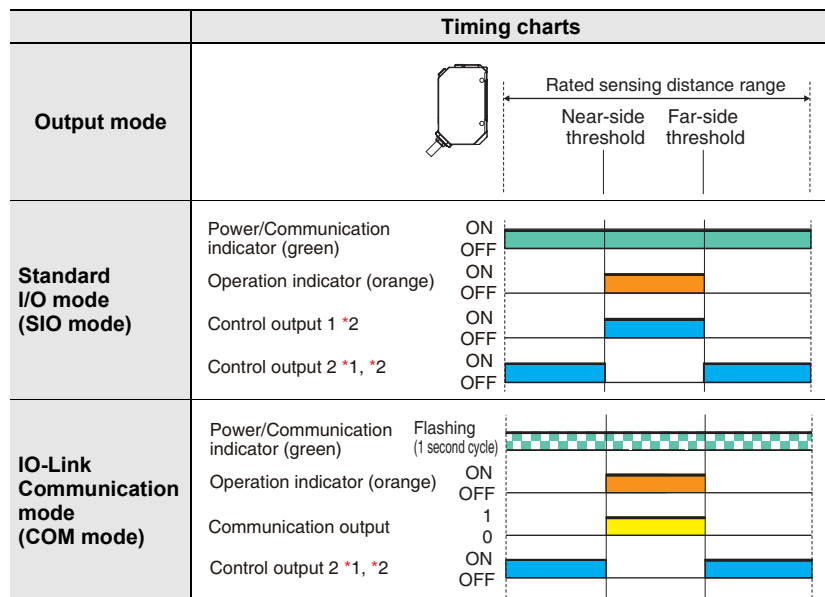

- *1. The initial value of control output 2 is reverse of control output 1.
- *2. The timer function of the control output can be set up by the IO-Link communications. (It is able to select ON delay, OFF delay, or one-shot function and select a timer time of 1 to 9,999 ms (T).)

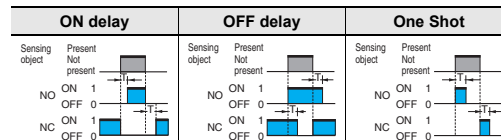

Please contact your OMRON sales representative regarding the IO-Link setup file (IODD file).

Window FGS mode [Window FGS]

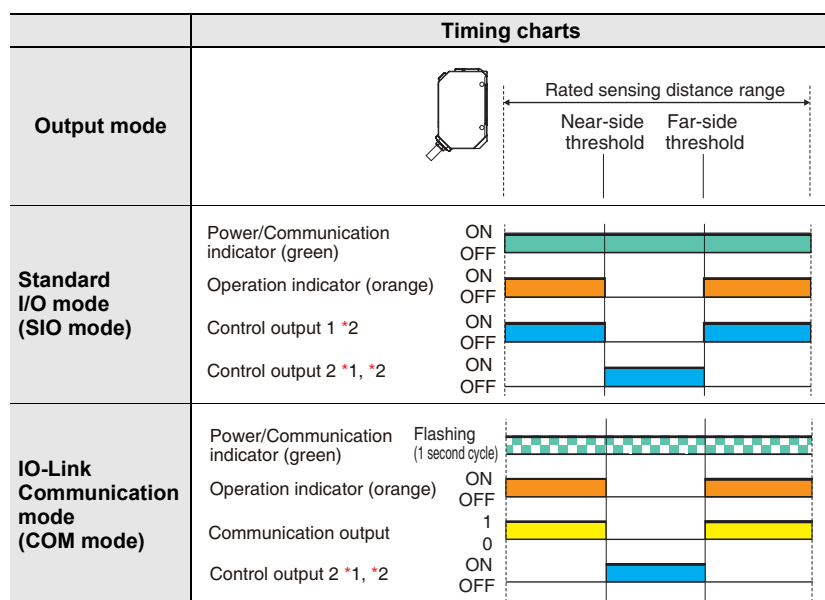

- *1. The initial value of control output 2 is reverse of control output 1.
- *2. The timer function of the control output can be set up by the IO-Link communications. (It is able to select ON delay, OFF delay, or one-shot function and select a timer time of 1 to 9,999 ms (T).)

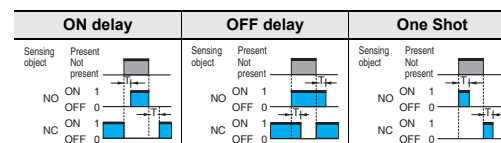

Please contact your OMRON sales representative regarding the IO-Link setup file (IODD file).

Note: Shown above are the factory settings. Refer to the index list for the default settings at time of shipment from factory. PNP/COM output logic can be reversed by IO-Link communication. The operation indicator (orange) lights up when control output 1 is ON or communication output is 1.

Nomenclature

E3AS-HL500□
E3AS-HL150□

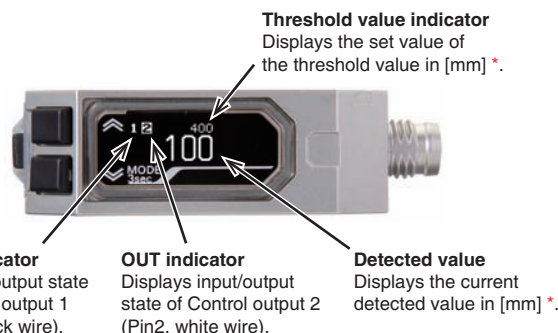
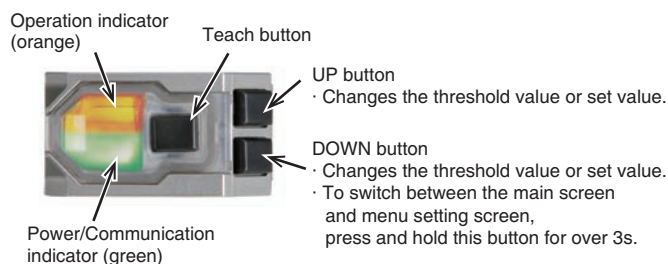

* The indicators work differently depending on sensor status.

* Reference value

E3AS-F models

NPN Output

Model	Timing chart	Output circuit
E3AS-F1500□□ E3AS-F1000□□	<p>Stability&Communication indicator (green) Operation indicator (orange) Control output 1 Control output 2 *</p>	<p>Connector Pin Arrangement M12 Pre-wired Smartclick Connector M8 Connector</p>

* The initial value of control output 2 is reverse of control output 1.

PNP Output

Model	Output circuit	
	Standard I/O mode (SIO mode) *1	IO-Link Communication mode (COM mode) *2
E3AS-F1500□□ E3AS-F1000□□	<p>Connector Pin Arrangement M12 Pre-wired Smartclick Connector M8 Connector</p>	<p>IO-Link Master Unit Connector Pin Arrangement M12 Pre-wired Smartclick Connector M8 Connector</p>

*1. Standard I/O mode is used as PNP ON/OFF output.

*2. IO-Link Communication mode is used for communications with the IO-Link Master. C/Q performs IO-Link communications. Sensor output DO performs ON/OFF output.

Output mode	Timing charts
Standard I/O mode (SIO mode)	<p>Stability&Communication indicator (green) Operation indicator (orange) Control output 1 *2 Control output 2 *1, *2</p>
IO-Link Communication mode (COM mode)	<p>Stability&Communication indicator (green) Flashing (1 second cycle) Operation indicator (orange) Communication output Control output 2 *1, *2</p>

*1. The initial value of control output 2 is reverse of control output 1.

*2. The timer function of the control output can be set by the IO-Link communications. (It is able to select ON delay, OFF delay, or one-shot function and select a timer time of 1 to 9,999 ms (T).)

ON delay		OFF delay		One Shot	
Sensing object	Present	Sensing object	Present	Sensing object	Present
	Not present		Not present		Not present
NO	ON 1	NO	ON 1	NO	ON 1
	OFF 0		OFF 0		OFF 0
NC	ON 1	NC	ON 1	NC	ON 1
	OFF 0		OFF 0		OFF 0

Please contact your OMRON sales representative regarding the IO-Link setup file (IODD file).

Note: Shown above are the factory settings. Refer to the index list for the default settings at time of shipment from factory.

PNP/COM output logic can be reversed by IO-Link communication.

The operation indicator (orange) lights up when control output 1 is ON or communication output is 1.

Nomenclature

E3AS-F1500□
E3AS-F1000□

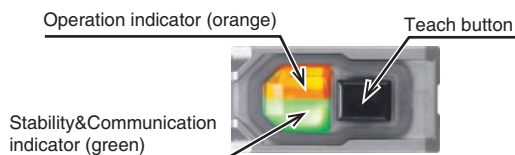

Note: The indicators work differently depending on sensor status.

E3AS-L models

NPN Output

Model	Timing chart	Output circuit
E3AS-L□N	<p>Stability&Communication indicator (green) *1</p> <p>Operation indicator (orange)</p> <p>Control output 1</p> <p>Control output 2 *2</p>	<p>Connector Pin Arrangement</p> <p>M12 Pre-wired Smartclick Connector</p> <p>M8 Connector</p>

*1. Turns off when there is insufficient margin for incident light. In that case, place the workpiece closer to ensure sufficient receiving light intensity.
 *2. The initial value of control output 2 is reverse of control output 1.

PNP Output

Model	Output circuit	
	Standard I/O mode (SIO mode) *1	IO-Link Communication mode (COM mode) *2
E3AS-L□T	<p>Connector Pin Arrangement</p> <p>M12 Pre-wired Smartclick Connector</p> <p>M8 Connector</p>	<p>IO-Link Master Unit</p> <p>Connector Pin Arrangement</p> <p>M12 Pre-wired Smartclick Connector</p> <p>M8 Connector</p>

*1. Standard I/O mode is used as PNP ON/OFF output.
 *2. IO-Link Communication mode is used for communications with the IO-Link Master. C/Q performs IO-Link communications. Sensor output DO performs ON/OFF output.

Output mode	Timing charts	
		Threshold
Standard I/O mode (SIO mode)	Stability&Communication indicator (green) *1	ON OFF
	Operation indicator (orange)	ON OFF
	Control output 1 *3	ON OFF
	Control output 2 *2	ON OFF
IO-Link Communication mode (COM mode)	Stability&Communication indicator (green)	Flashing (1 second cycle)
	Operation indicator (orange)	ON OFF
	Communication output	1 0
	Control output 2 *2	ON OFF

*1. Turns off when there is insufficient margin for incident light. In that case, place the workpiece closer to ensure sufficient receiving light intensity.
 *2. The initial value of control output 2 is reverse of control output 1.
 *3. The timer function of the control output 2 can be set up by the IO-Link communications. (It is able to select ON delay, OFF delay, or one-shot function and select a timer time of 1 to 9,999 ms (T).)

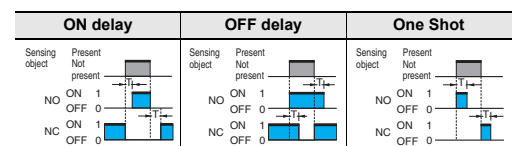

Please contact your OMRON sales representative regarding the IO-Link setup file (IODD file).

Note: Shown above are the factory settings. Refer to the index list for the default settings at time of shipment from factory.
 PNP/COM output logic can be reversed by IO-Link communication.
 The operation indicator (orange) lights up when control output 1 is ON or communication output is 1.

Nomenclature

E3AS-L200□
 E3AS-L80□

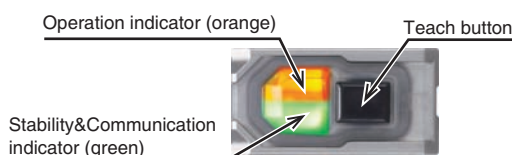

Note: The indicators work differently depending on sensor status.

E3AS Series

Safety Precautions

Be sure to read the precautions for all models in the website at: <http://www.ia.omron.com/>.

Warning Indications

WARNING	Warning level Indicates a potentially hazardous situation which, if not avoided, will result in minor or moderate injury, or may result in serious injury or death. Additionally there may be significant property damage.
CAUTION	Caution level Indicates a potentially hazardous situation which, if not avoided, may result in minor or moderate injury or in property damage.
Precautions for Safe Use	Supplementary comments on what to do or avoid doing, to use the product safely.
Precautions for Correct Use	Supplementary comments on what to do or avoid doing, to prevent failure to operate, malfunction or undesirable effect on product performance.

Meaning of Product Safety Symbols

	General prohibition Indicates the instructions of unspecified prohibited action
	Caution, fire Indicates the possibility of fires under specific conditions.
	General caution Indicates unspecified general alert.
	Caution, explosion Indicates the possibility of explosion under specific conditions
	Laser Caution Indicates information related to laser safety
	Disassembly prohibited Prohibit the disassembly of a device because of the possibility of injuries due to electric shock.

WARNING

This product is not designed or rated for ensuring safety of persons either directly or indirectly. Do not use it for such purposes.

Do not use it exceeding the rated voltage. There is a possibility of failure and fire.

CAUTION

Its component may be damaged and/or degree of protection may be degraded. Please do not apply high pressure water intensively at one place during cleaning.

Never use the product with an AC power supply. Otherwise, explosion may result.

E3AS-HL and E3AS-F models

To safely use laser products

WARNING

Do not expose your eyes to the laser beam either directly or indirectly (i.e., after reflection from a mirror or shiny surface). The laser beam has a high power density and exposure may result in loss of sight.

Do not disassemble this product. Doing so may cause exposure to the built-in light source which can damage eyes and skin. Never disassemble it.

Laser safety measures for laser equipment are stipulated by the country of use. Follow the instructions described below categorized in four cases.

- Usage in Japan**
The JIS C6802:2014 standard stipulates the safety precautions that users must take according to the class of the laser product. This product is classified into class 1 defined by this standard.
- Usage in U.S.**
This product is subjected to the U.S. FDA (Food and Drug Administration) laser regulations. This product is classified into Class 1 by the IEC 60825-1:2014 standard according to the regulations of Laser Notice No.56 of the FDA standard. This product is already reported to CDRH (Center for Devices and Radiological Health).
Accession Number: 1920014-001
When using a device equipped with the product in the U.S., attach an FDA certification label near the sensor mounted on customer equipment.

FDA certification label

This laser product complies with 21 CFR 1040.10 and 1040.11 except for deviations pursuant to Laser Notice No. 50, dated June 24, 2007
OMRON Corporation
Shikokoji Horikawa, Shimogyo-ku,
Kyoto 600-8530 JAPAN
Place of manufacture:
Shanghai Factory, OMRON Corp.
Manufactured in

- Usage in China**
This product is classified into Class 2 by the GB7247.1:2012 (IEC60825-1:2007) standard.
When using a device equipped with the product in China, attach a Warning label near the sensor mounted on customer equipment.

Warning label



- Usage in countries other than U.S. and China**
This product is classified into Class 1 by the IEC/EN 60825-1:2014 standard.

Precautions for Safe Use

The following precautions must be observed to ensure safe operation.

1. Do not reverse the power supply connection or connect to an AC current.
2. Do not short the load.
3. Be sure that before making supply the supply voltage is less than the maximum rated supply voltage (30 VDC).
4. Do not use the product in environments subject to flammable or explosive gases.
5. Do not use the product under a chemical or an oil environment without prior evaluation.
6. Do not attempt to modify the product.
7. Do not touch the metal surface with your bare hands when the temperature is low. Touching the surface may result in a cold burn.
8. Burn injury may occur. The product surface temperature rises depending on application conditions, such as the ambient temperature and the power supply voltage. Attention must be paid during operation or cleaning.

Precautions for Correct Use

1. Do not hit the product using a hammer for installation.
2. The product must be installed with the specified torque or less. For M8 connector, the proper tightening torque is from 0.3 to 0.4 N·m. In case of M12 smartclick connector, manually tighten the connector.
3. Tightening torque for the mounting hole is 0.6 N·m or less (M3 screw).
4. Do not use the product in any atmosphere or environment that exceeds the ratings.
5. Output pulses may occur when the power supply is turned OFF. We recommend that you turn OFF the power supply to the load or load line first.
6. Use an extension cable less than 100 m long for Standard I/O mode and less than 20 m for IO-Link Communication mode.
7. Do not pull on the cable with excessive strength.
8. Be sure to turn off the power supply when connecting or disconnecting the cable.
9. Please wait for at least 600 ms (E3AS-HL), 500 ms (E3AS-F), 100 ms (E3AS-L) after turning on the product's power until it is available for use.
10. Though this is type IP67, do not use in the water, rain or outdoors.
11. If the Sensor wiring is placed in the same conduits or ducts as high-voltage or high-power lines, inductive noise may cause malfunction or damage. Wire the cables separately or use a shielded cable.
12. Do not use the product in locations subject to direct sunlight.
13. Do not use the product where humidity is high and dew condensation may occur.
14. Do not use the product where corrosive gases may exist.
15. If high-pressure washing water and so on hits the button, it might lead to malfunctioning. So, consider use of the key lock function.
16. Do not apply high-pressure washing water directly to the sensor's light emitting / receiving surface from a short distance. As the antifouling feature may be impaired, keep a sufficient distance from the light emitting / receiving surface.
17. Do not use the product at a location subject to shock or vibration.
18. To use a commercially available switching regulator, FG (frame ground) must be grounded.
19. Do not use organic solvents (e.g. paint thinner and alcohol) for cleaning. Otherwise optical properties and protective structure may deteriorate.
20. Be sure to check the influence caused by surrounding environments such as background objects and LED lighting before using the product.
21. Do not exceed 100,000 writing operations of the EEPROM (non-volatile memory). Setting information is written to the EEPROM when a threshold value change, teaching, or zero reset is executed.
22.  Please dispose in accordance with applicable regulations.



E3AS Series

Dimensions

(Unit: mm)

Tolerance class IT16 applies to dimensions in this data sheet unless otherwise specified.

Sensors

Pre-wired Models/Pre-wired Connector Models

E3AS-HL500□ (-M1TJ)

E3AS-HL150□ (-M1TJ)

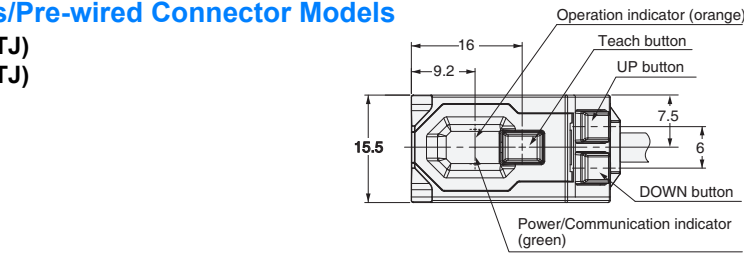

Pre-wired Connector Models
E3AS-HL500□-M1TJ
E3AS-HL150□-M1TJ

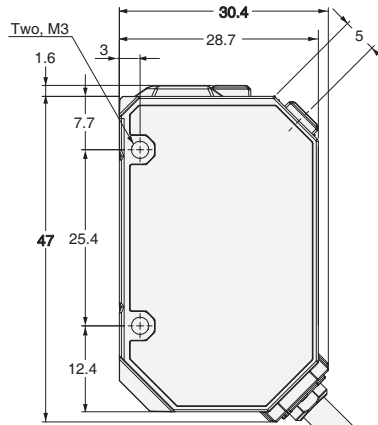
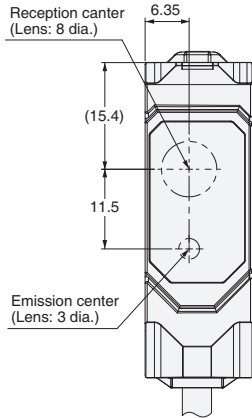
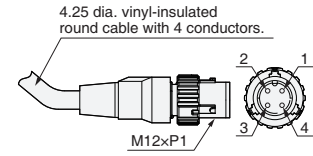

4.25 dia. vinyl-insulated round cable with 4 conductors
(Conductor cross section: 0.3 mm²,
Insulator diameter: 1.05 mm),
Standard length: 2 m

Minimum bending radius/unbendable length of cord

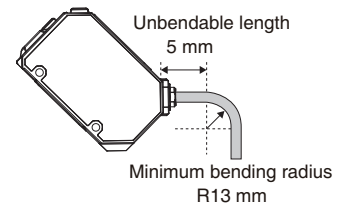

Connector Models

E3AS-HL500□ M3

E3AS-HL150□ M3

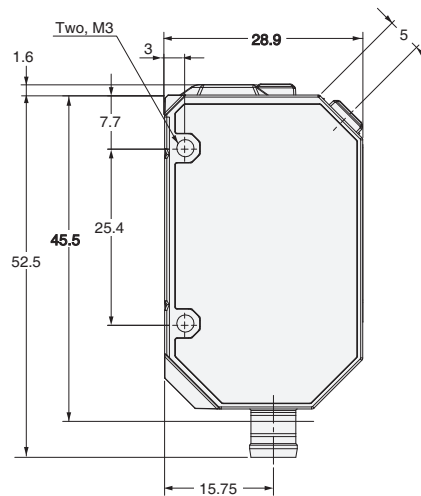
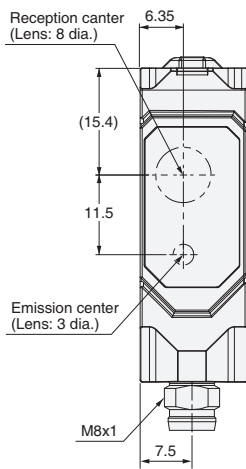
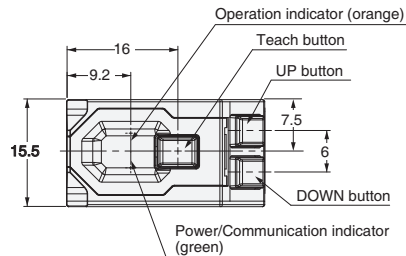

Pre-wired Models/Pre-wired Connector Models

E3AS-F1500□ (-M1TJ)
E3AS-F1000□ (-M1TJ)

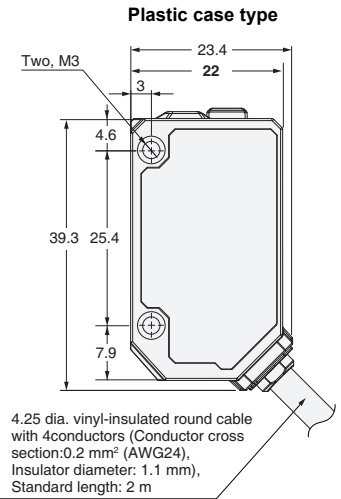
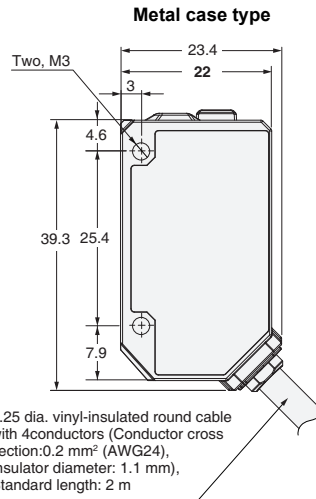
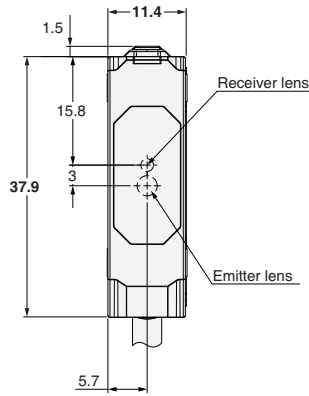
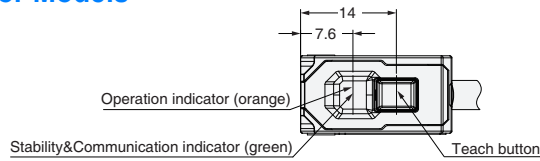

Minimum bending radius/unbendable length of cord

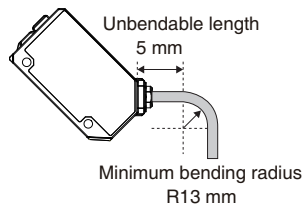

M12 Pre-wired Smartclick Connector type
E3AS-F1500□-M1TJ/E3AS-F1000□-M1TJ

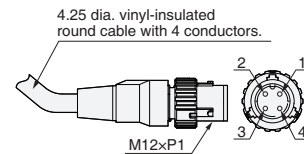

Connector Models

E3AS-F1500□ M3
E3AS-F1000□ M3

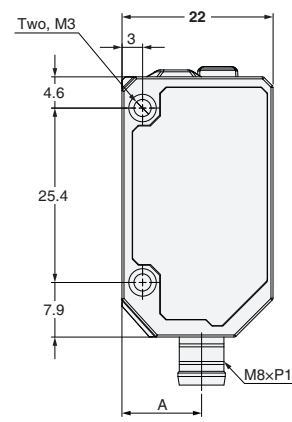
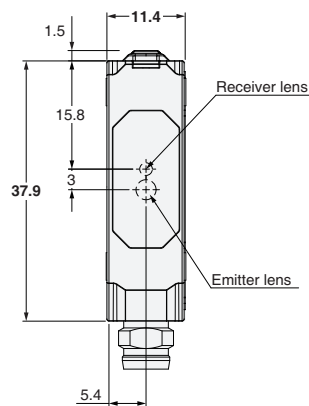
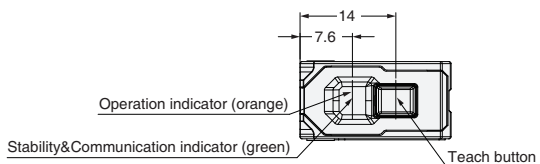

A:
Metal case type (E3AS-F□M□ M3) :9.6mm
Plastic case type (E3AS-F□P□ M3) :11.6mm

E3AS Series

Pre-wired Models/Pre-wired Connector Models

E3AS-L200□ (-M1TJ)

E3AS-L80□ (-M1TJ)

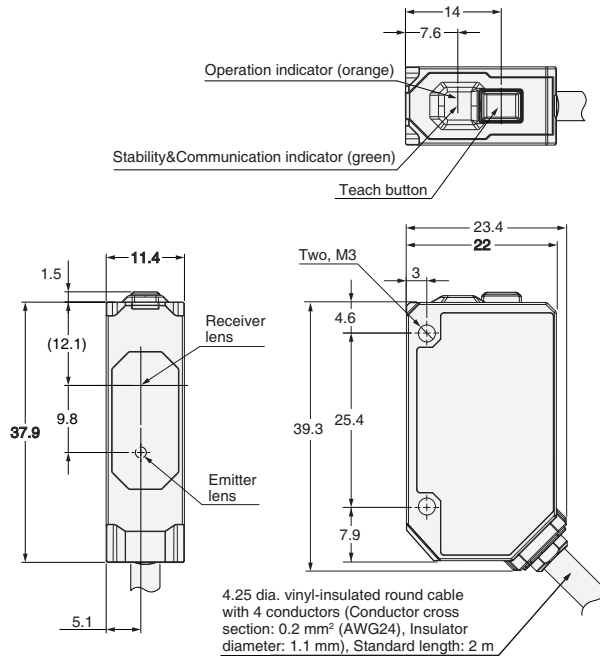

M12 Pre-wired Smartclick Connector type
E3AS-L200□-M1TJ/E3AS-L80□-M1TJ

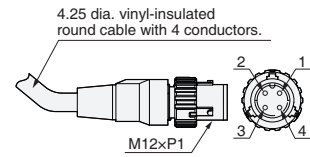

Minimum bending radius/unbendable length of cord

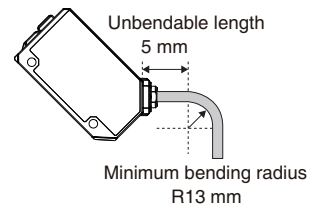

Connector Models

E3AS-L200□ M3

E3AS-L80□ M3

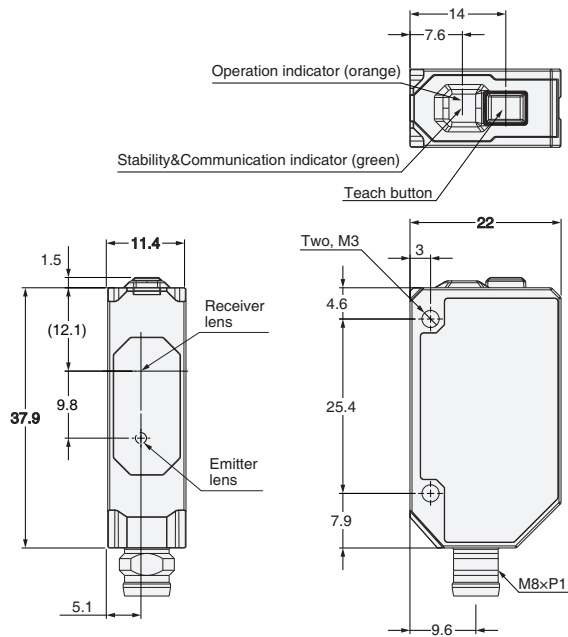

Accessories (Sold Separately)

Mounting Brackets

For E3AS-HL models

E39-L221

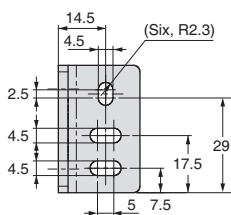

Photoelectric Sensor
Accessory are installed
(Example of E3AS-HL500□)

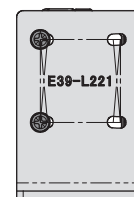
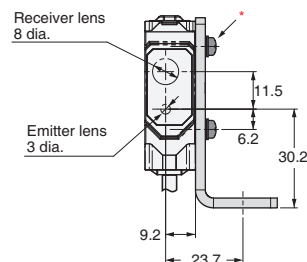
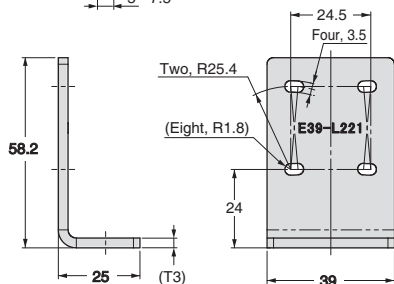
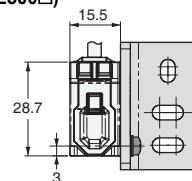

Material: Stainless steel (SUS304)

* Accessories

2-M3-L10 Cross Recessed Pan Head Screws (Attached to SW+JIS W)

E39-L222

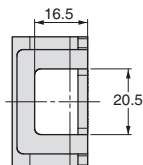

Photoelectric Sensor
Accessory are installed
(Example of E3AS-HL500□)

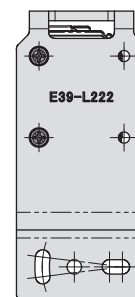
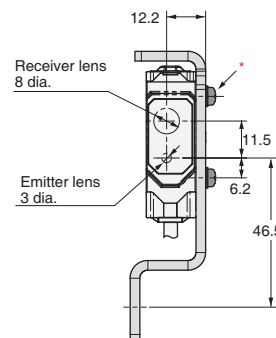
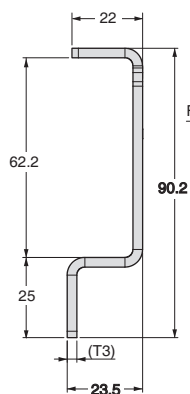
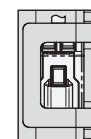

Material: Stainless steel (SUS304)

* Accessories

2-M3-L10 Cross Recessed Pan Head Screws (Attached to SW+JIS W)

E39-L223

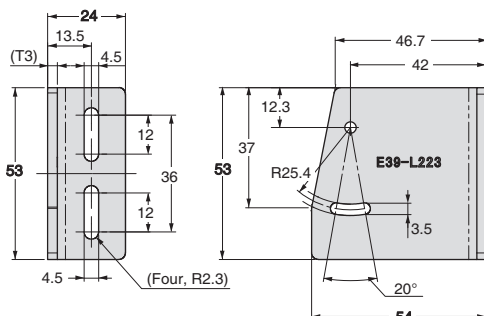

Photoelectric Sensor
Accessory are installed
(Example of E3AS-HL500□)

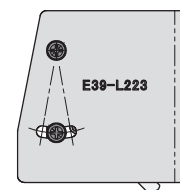
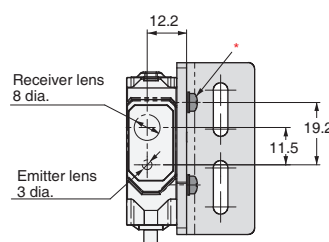

Material: Stainless steel (SUS304)

* Accessories

2-M3-L10 Cross Recessed Pan Head Screws (Attached to SW+JIS W)

E3AS Series

E39-L224

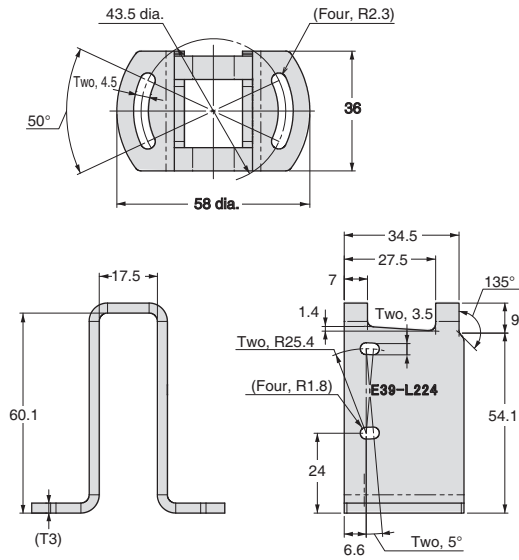

Photoelectric Sensor
Accessory are installed
(Example of E3AS-HL500□)

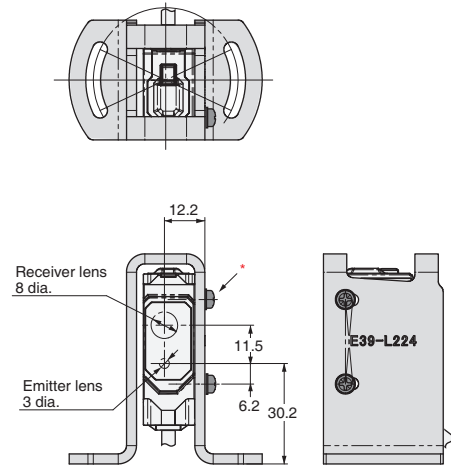

Material: Stainless steel (SUS304)

* Accessories
2-M3-L10 Cross Recessed Pan Head Screws (Attached to SW+JIS W)

E39-L231

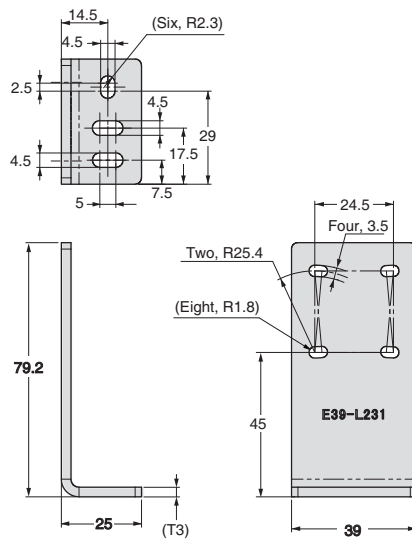

Photoelectric Sensor
Accessory are installed
(Example of E3AS-HL500□)

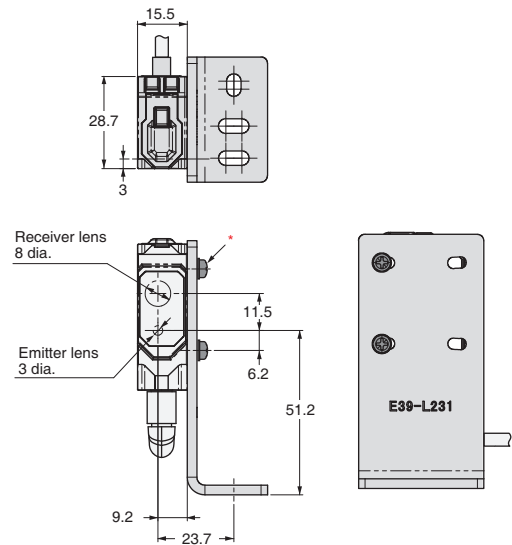

Material: Stainless steel (SUS304)

* Accessories
2-M3-L10 Cross Recessed Pan Head Screws (Attached to SW+JIS W)

E39-L232

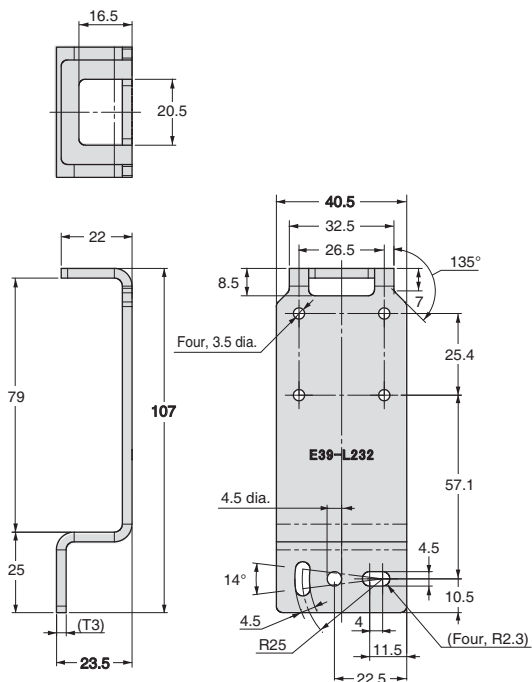

**Photoelectric Sensor
Accessory are installed
(Example of E3AS-HL500□)**

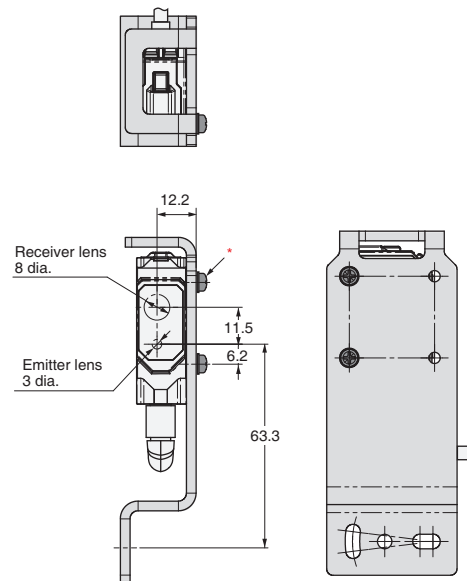

Material: Stainless steel (SUS304)

* Accessories

2-M3-L10 Cross Recessed Pan Head Screws (Attached to SW+JIS W)

E39-L234

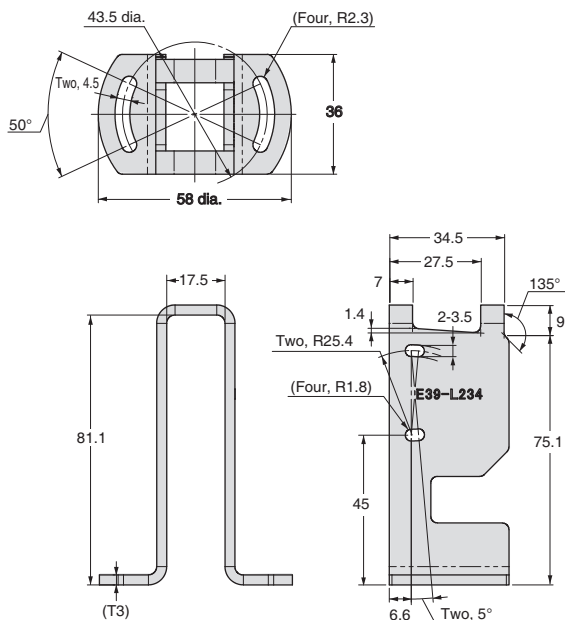

**Photoelectric Sensor
Accessory are installed
(Example of E3AS-HL500□)**

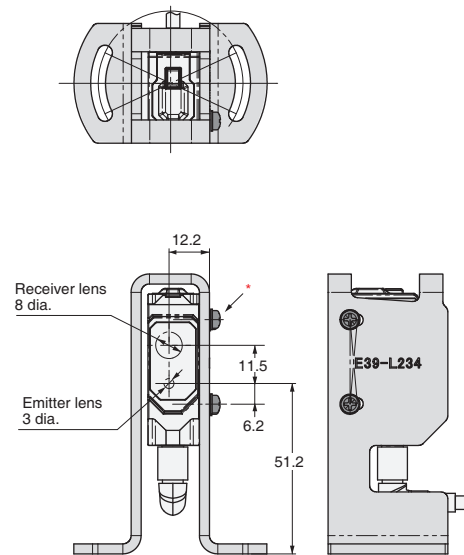

Material: Stainless steel (SUS304)

* Accessories

2-M3-L10 Cross Recessed Pan Head Screws (Attached to SW+JIS W)

Ordering Information

Ratings and Specifications

Engineering Data

I/O Circuit Diagrams/Timing Charts

Nomenclature

Safety Precautions

Dimensions

E3AS Series

E39-E19

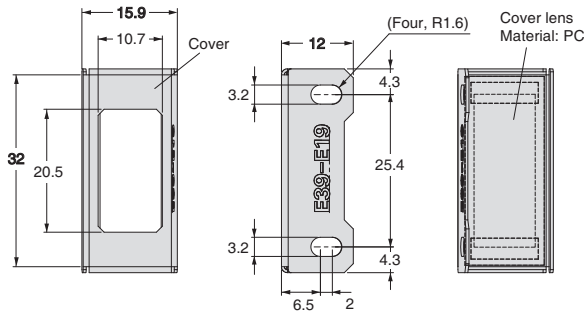
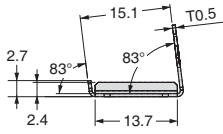

Photoelectric Sensor
Accessory are installed
(Example of E3AS-HL500□)

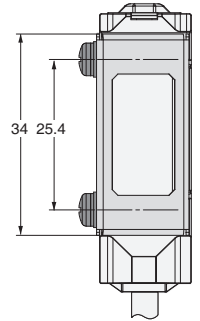
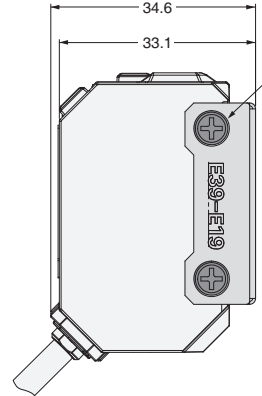
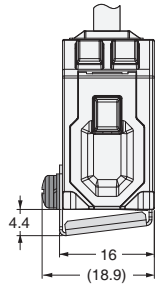

Material: Stainless steel (SUS304)

* Accessories

2-M3-L10 Cross Recessed Pan Head Screws (Attached to SW+JIS W)

For E3AS-F/L models

E39-L201

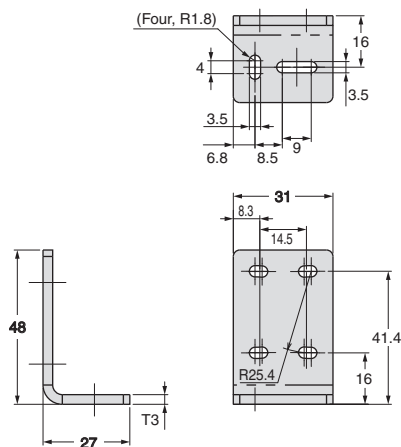

Photoelectric Sensor
Accessory are installed
(Example of E3AS-L200□)

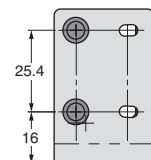
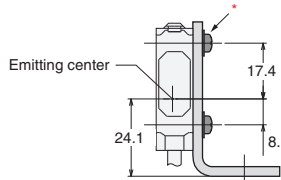
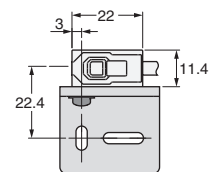

Material: Stainless steel (SUS304)

* Accessories

2-M3-L12 Cross Recessed Pan Head Screws (Attached to SW+JIS W)

E39-L202

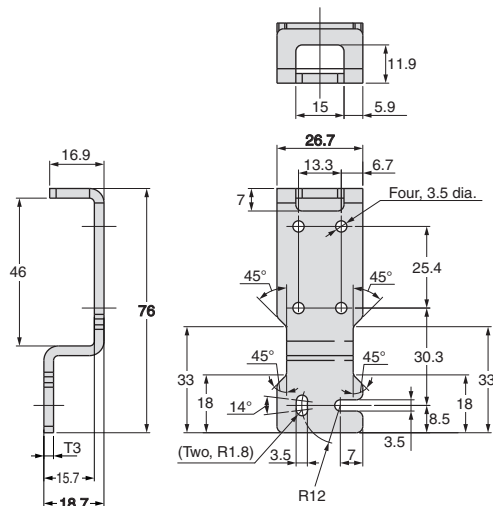

Photoelectric Sensor
Accessory are installed
(Example of E3AS-L200□)

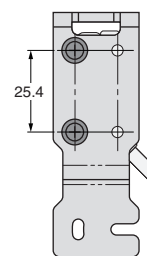
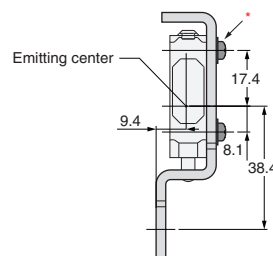
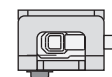

Material: Stainless steel (SUS304)

* Accessories

2-M3-L12 Cross Recessed Pan Head Screws (Attached to SW+JIS W)

E39-L203

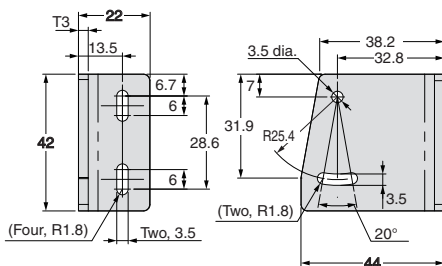

Photoelectric Sensor
Accessory are installed
(Example of E3AS-L200□)

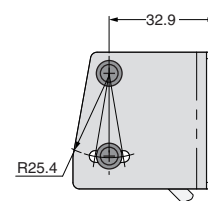
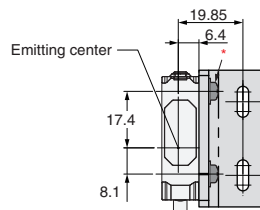

Material: Stainless steel (SUS304)

* Accessories

2-M3-L12 Cross Recessed Pan Head Screws (Attached to SW+JIS W)

E3AS Series

E39-L204

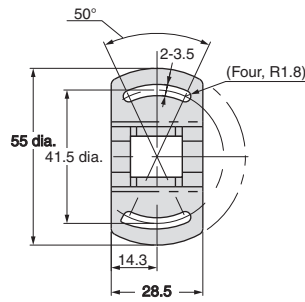

Photoelectric Sensor
Accessory are installed
(Example of E3AS-L200□)

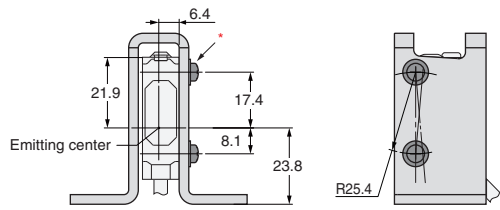
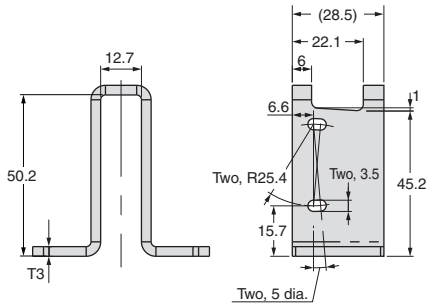
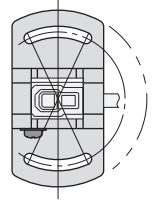

Material: Stainless steel (SUS304)

* Accessories

2-M3-L12 Cross Recessed Pan Head Screws (Attached to SW+JIS W)

E39-L211

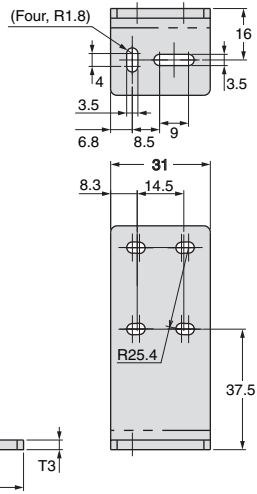

Photoelectric Sensor
Accessory are installed
(Example of E3AS-L200□)

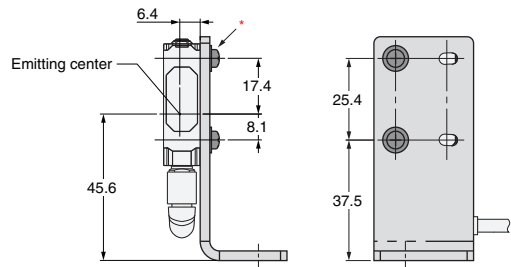
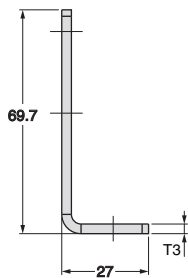
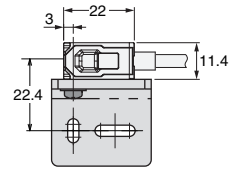

Material: Stainless steel (SUS304)

* Accessories

2-M3-L12 Cross Recessed Pan Head Screws (Attached to SW+JIS W)

E39-L212

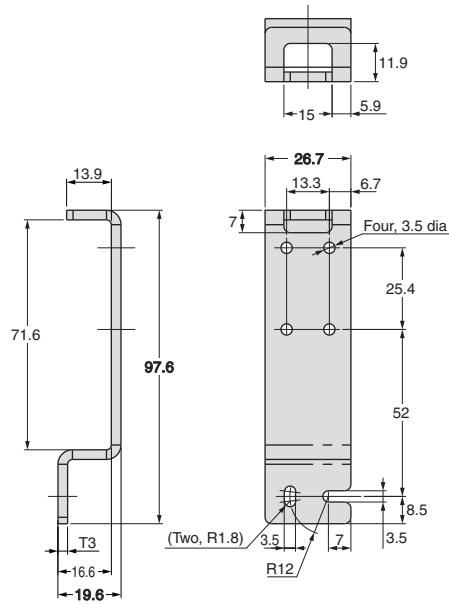

Photoelectric Sensor
Accessory are installed
(Example of E3AS-L200□)

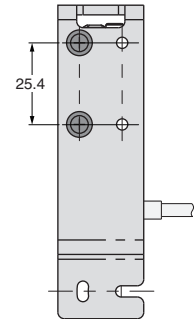
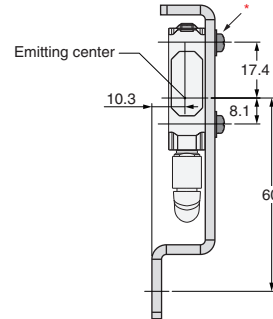
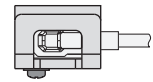

Material: Stainless steel (SUS304)

* Accessories

2-M3-L12 Cross Recessed Pan Head Screws (Attached to SW+JIS W)

E39-L214

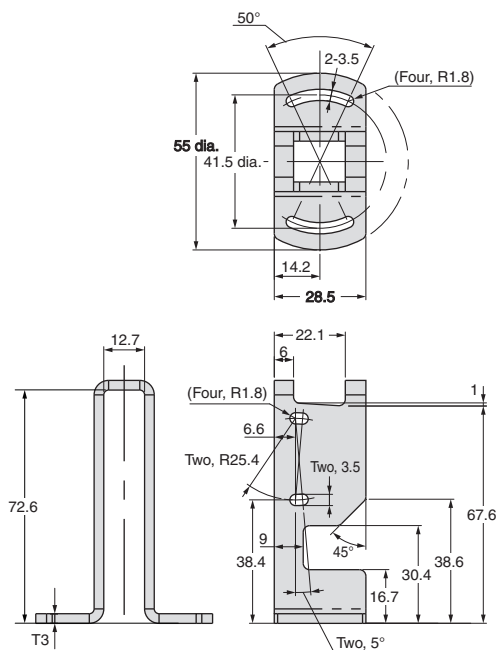

Photoelectric Sensor
Accessory are installed
(Example of E3AS-L200□)

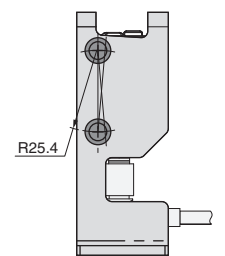
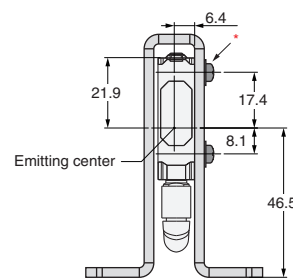
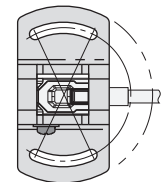

Material: Stainless steel (SUS304)

* Accessories

2-M3-L12 Cross Recessed Pan Head Screws (Attached to SW+JIS W)

E3AS Series

Common to E3AS series

Flexible Mounting Bracket E39-L261

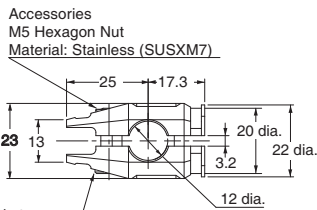

Accessories
M5-L15 Hexagon Socket
Head Cap Screws
Material: Stainless (SUSXM7)

Material: ZDC2
Finished: Ni Plating

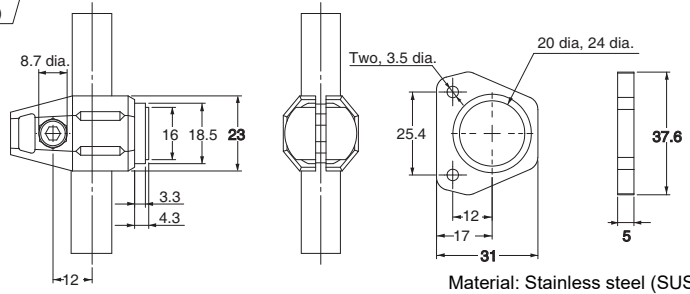

Photoelectric Sensor Accessory are installed (Example of E3AS-HL500□)

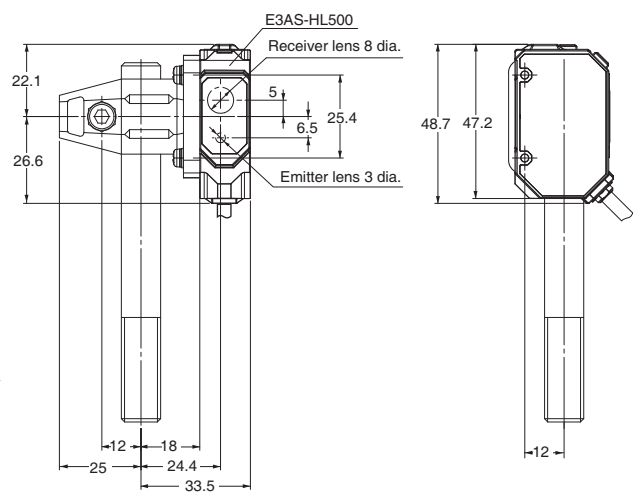
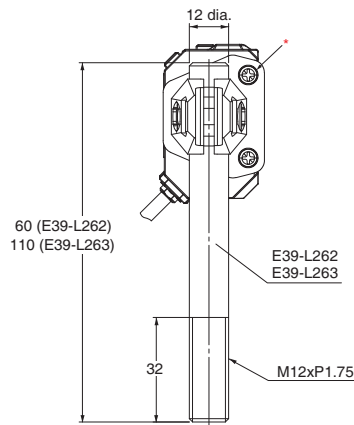
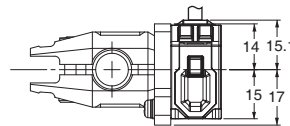

Photoelectric Sensor Accessory are installed (Example of E3AS-HL500□)

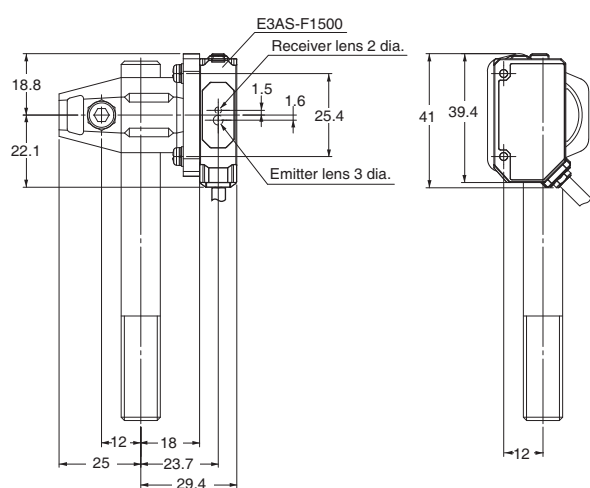
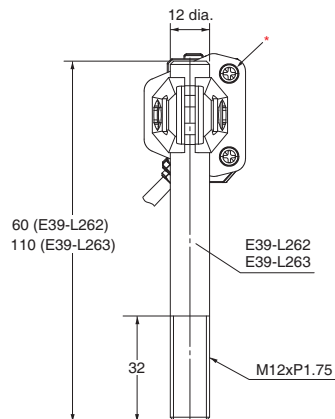
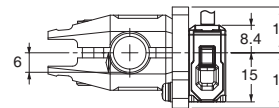

* Accessories 2-M3-L10 Cross Recessed Pan Head Screws (Attached to SW+JIS)

**Post 50 mm
E39-L262**

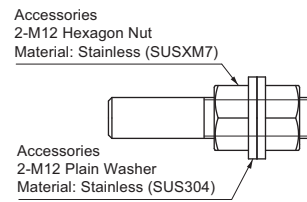
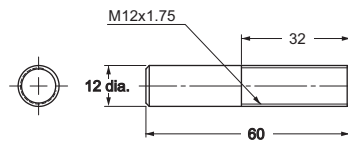

Material: Stainless steel (SUS304)

**Post 100 mm
E39-L263**

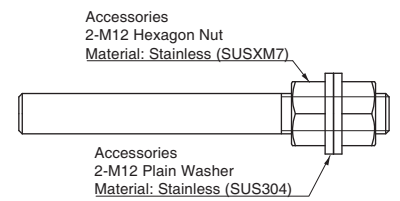
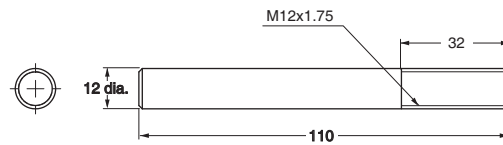

Material: Stainless steel (SUS304)

E3AS Series

Air Blow Unit E39-E16

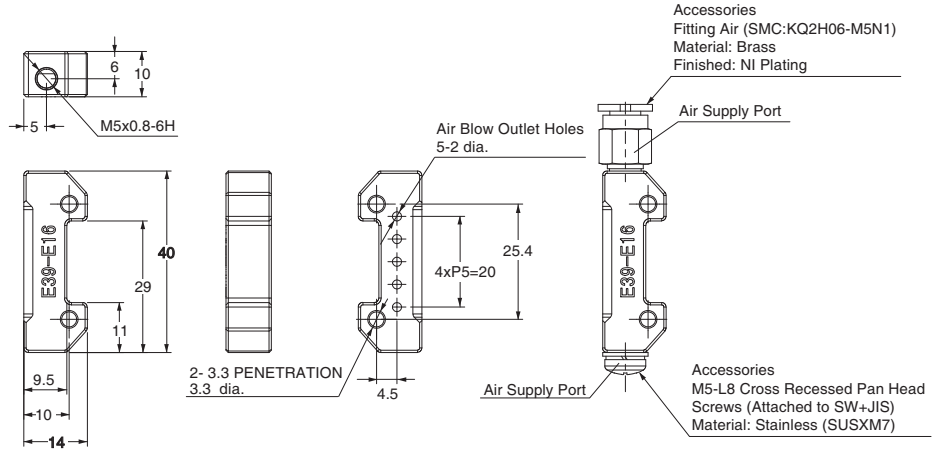

Photoelectric Sensor Accessory are installed (Example of E3AS-HL500□)

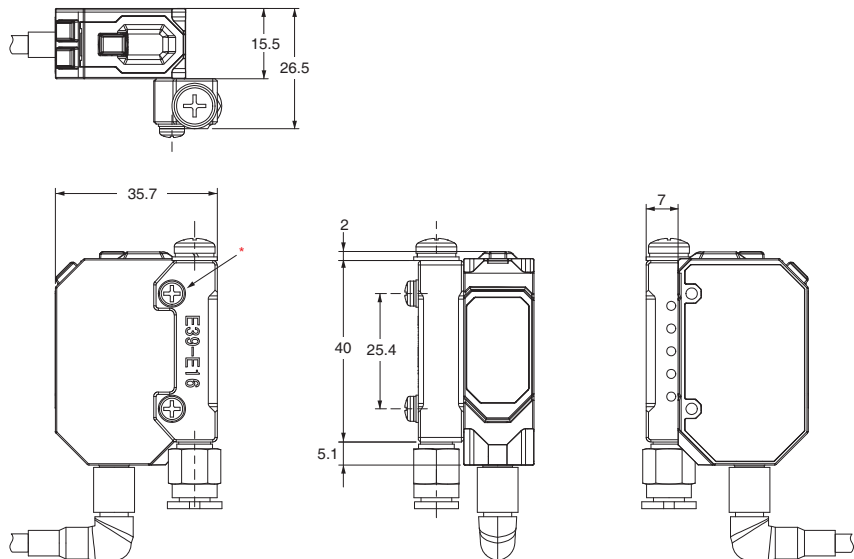

Photoelectric Sensor Accessory are installed (Example of E3AS-HL500□)

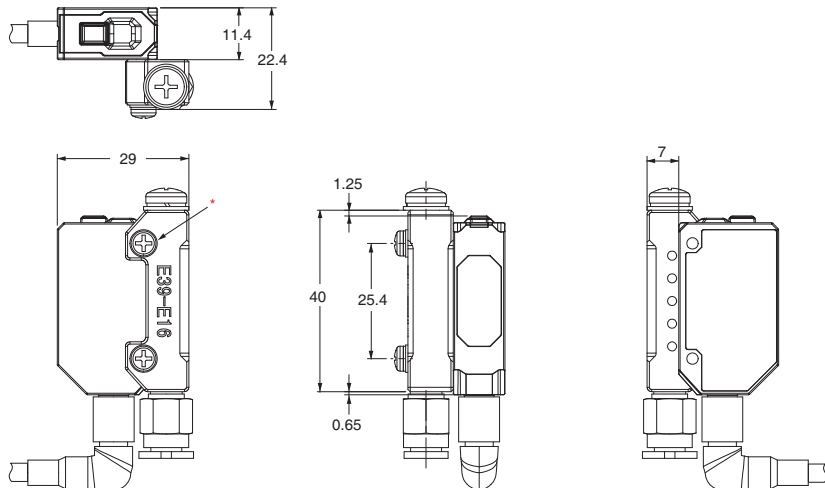

Material: ZDC2
 Finished: NI Plating
 * Accessories 2-M3-L16 Cross Recessed Pan Head Screws (Attached to SW+JIS)

- EtherCAT® is a registered trademark and patented technology, licensed by Beckhoff Automation GmbH, Germany.
- EtherNet/IP™ is a trademark of ODVA.
- Ecolab and its logo are registered trademarks of Ecolab USA Inc.
- Smartclick is a registered trademark of OMRON Corporation.
- Other company names and product names in this document are the trademarks or registered trademarks of their respective companies.
- The product photographs and figures that are used in this catalog may vary somewhat from the actual products.

Terms and Conditions Agreement

Read and understand this catalog.

Please read and understand this catalog before purchasing the products. Please consult your OMRON representative if you have any questions or comments.

Warranties.

(a) Exclusive Warranty. Omron's exclusive warranty is that the Products will be free from defects in materials and workmanship for a period of twelve months from the date of sale by Omron (or such other period expressed in writing by Omron). Omron disclaims all other warranties, express or implied.

(b) Limitations. OMRON MAKES NO WARRANTY OR REPRESENTATION, EXPRESS OR IMPLIED, ABOUT NON-INFRINGEMENT, MERCHANTABILITY OR FITNESS FOR A PARTICULAR PURPOSE OF THE PRODUCTS. BUYER ACKNOWLEDGES THAT IT ALONE HAS DETERMINED THAT THE PRODUCTS WILL SUITABLY MEET THE REQUIREMENTS OF THEIR INTENDED USE.

Omron further disclaims all warranties and responsibility of any type for claims or expenses based on infringement by the Products or otherwise of any intellectual property right. (c) Buyer Remedy. Omron's sole obligation hereunder shall be, at Omron's election, to (i) replace (in the form originally shipped with Buyer responsible for labor charges for removal or replacement thereof) the non-complying Product, (ii) repair the non-complying Product, or (iii) repay or credit Buyer an amount equal to the purchase price of the non-complying Product; provided that in no event shall Omron be responsible for warranty, repair, indemnity or any other claims or expenses regarding the Products unless Omron's analysis confirms that the Products were properly handled, stored, installed and maintained and not subject to contamination, abuse, misuse or inappropriate modification. Return of any Products by Buyer must be approved in writing by Omron before shipment. Omron Companies shall not be liable for the suitability or unsuitability or the results from the use of Products in combination with any electrical or electronic components, circuits, system assemblies or any other materials or substances or environments. Any advice, recommendations or information given orally or in writing, are not to be construed as an amendment or addition to the above warranty.

See <http://www.omron.com/global/> or contact your Omron representative for published information.

Limitation on Liability; Etc.

OMRON COMPANIES SHALL NOT BE LIABLE FOR SPECIAL, INDIRECT, INCIDENTAL, OR CONSEQUENTIAL DAMAGES, LOSS OF PROFITS OR PRODUCTION OR COMMERCIAL LOSS IN ANY WAY CONNECTED WITH THE PRODUCTS, WHETHER SUCH CLAIM IS BASED IN CONTRACT, WARRANTY, NEGLIGENCE OR STRICT LIABILITY.

Further, in no event shall liability of Omron Companies exceed the individual price of the Product on which liability is asserted.

Suitability of Use.

Omron Companies shall not be responsible for conformity with any standards, codes or regulations which apply to the combination of the Product in the Buyer's application or use of the Product. At Buyer's request, Omron will provide applicable third party certification documents identifying ratings and limitations of use which apply to the Product. This information by itself is not sufficient for a complete determination of the suitability of the Product in combination with the end product, machine, system, or other application or use. Buyer shall be solely responsible for determining appropriateness of the particular Product with respect to Buyer's application, product or system. Buyer shall take application responsibility in all cases.

NEVER USE THE PRODUCT FOR AN APPLICATION INVOLVING SERIOUS RISK TO LIFE OR PROPERTY OR IN LARGE QUANTITIES WITHOUT ENSURING THAT THE SYSTEM AS A WHOLE HAS BEEN DESIGNED TO ADDRESS THE RISKS, AND THAT THE OMRON PRODUCT(S) IS PROPERLY RATED AND INSTALLED FOR THE INTENDED USE WITHIN THE OVERALL EQUIPMENT OR SYSTEM.

Programmable Products.

Omron Companies shall not be responsible for the user's programming of a programmable Product, or any consequence thereof.

Performance Data.

Data presented in Omron Company websites, catalogs and other materials is provided as a guide for the user in determining suitability and does not constitute a warranty. It may represent the result of Omron's test conditions, and the user must correlate it to actual application requirements. Actual performance is subject to the Omron's Warranty and Limitations of Liability.

Change in Specifications.

Product specifications and accessories may be changed at any time based on improvements and other reasons. It is our practice to change part numbers when published ratings or features are changed, or when significant construction changes are made. However, some specifications of the Product may be changed without any notice. When in doubt, special part numbers may be assigned to fix or establish key specifications for your application. Please consult with your Omron's representative at any time to confirm actual specifications of purchased Product.

Errors and Omissions.

Information presented by Omron Companies has been checked and is believed to be accurate; however, no responsibility is assumed for clerical, typographical or proofreading errors or omissions.

Related Products



Transparent Object Detection
Photoelectric Sensor
E3S-DB

Cat. No. E440-E1



Color Mark Sensors
E3S-DC/E3NX-CA Series

Cat. No. Y216-E1



IO-Link Series

Cat. No. Y229-E1

Note: Do not use this document to operate the Unit.

OMRON Corporation Industrial Automation Company

Kyoto, JAPAN

Contact : www.ia.omron.com

Regional Headquarters

OMRON EUROPE B.V.

Wegalaan 67-69, 2132 JD Hoofddorp
The Netherlands
Tel: (31) 2356-81-300 Fax: (31) 2356-81-388

OMRON ELECTRONICS LLC

2895 Greenspoint Parkway, Suite 200
Hoffman Estates, IL 60169 U.S.A.
Tel: (1) 847-843-7900 Fax: (1) 847-843-7787

OMRON ASIA PACIFIC PTE. LTD.

438B Alexandra Road, #08-01/02 Alexandra
Technopark, Singapore 119968
Tel: (65) 6835-3011 Fax: (65) 6835-2711

OMRON (CHINA) CO., LTD.

Room 2211, Bank of China Tower,
200 Yin Cheng Zhong Road,
PuDong New Area, Shanghai, 200120, China
Tel: (86) 21-5037-2222 Fax: (86) 21-5037-2200

Authorized Distributor:

©OMRON Corporation 2020-2023 All Rights Reserved.
In the interest of product improvement,
specifications are subject to change without notice.

CSM_5_1

Cat. No. E595-E1-05 0423 (1020)